

- **Designed for 345 MHz Wireless Applications**
- **Advanced (Lithium Tantalate) LiTaO₃ design for low Insertion Loss**
- **Designed for match to 50 ohms, no external LC required**
- **Hermetically sealed Surface Mount package**
- **Complies with Directive 2002/95/EC (RoHS)**

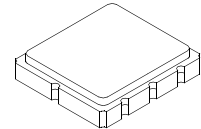

RF1353C

**345.00 MHz
SAW Filter**



SM5050-8 Case

Absolute Maximum Ratings

Rating	Value	Units
Maximum Input Power	+10	dBm
Maximum DC Voltage Between Terminals	30	VDC
Case Temperature	-40 to +85	°C

Characteristic	Sym	Notes	Minimum	Typical	Maximum	Units
Nominal Operating Frequency	f_C			345		MHz
Passband	IL	Insertion Loss			4.5	dB
		3.0 dB Bandwidth	$f_C \pm 70$	$f_C \pm 430$	$f_C \pm 1100$	kHz
Rejection		$f_C - 10.7$ MHz	15			dB
		$f_C - 21.4$ MHz	40			dB
Matching		Untuned response		50		Ω
Ambient Temperature		Operating Range	-10		70	°C
Footprint: 5.0 X 5.0 mm	SM5050-8					
Lid Symbolization (YY=Year, WW=week, S=shift)	446, <u>Y</u> WWS					

Electrical Connections

Connection	Terminals
RF Input	2
RFOutput	6
Case Ground	All Others



CAUTION: Electrostatic Sensitive Device. Observe precautions for handling.

NOTES:

1. All specifications apply over the operating temperature range with filter soldered to the specified demonstration board unless noted otherwise.
2. Ultimate rejection is dependent on PCB layout.
3. Specifications subject to change without notice.
4. Electrostatic Sensitive Device. Observe precautions for handling.
5. US and international patents may apply.
6. Murata, stylized Murata logo, and Murata N.A., Inc. are registered trademarks of Murata Manufacturing Co., Ltd.

SM5050-8 Case

8-Terminal Ceramic Surface-Mount Case

5.0 X 5.0 mm Nominal Footprint

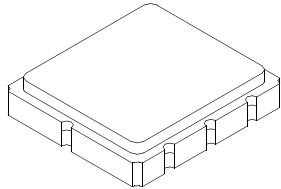

Case Dimensions

Dimension	mm			Inches		
	Min	Nom	Max	Min	Nom	Max
A	4.8	5.0	5.2		0.1968	
B	4.8	5.0	5.2		0.1968	
C			1.7			0.0669
D		2.08			0.0818	
E		1.17			0.046	
F		0.64			0.0252	
G	2.39	2.54	2.69		0.100	

Electrical Connections

Connection		Terminals
Port 1	Differential Input	1, 2
Port 2	Differential Output	5, 6
	Ground	All others
Single-ended Operation		Return is ground
Differential Operation		Return is hot
Dot indicates Pin 1		

TOP VIEW

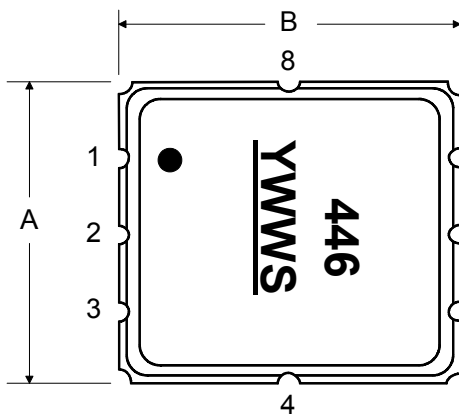

BOTTOM VIEW

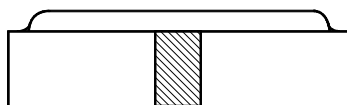
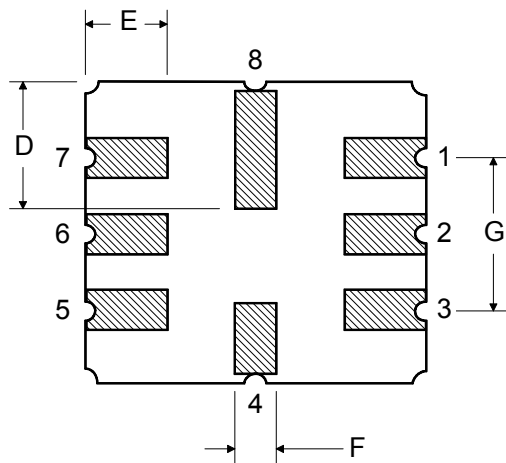

Tape and Reel Specifications

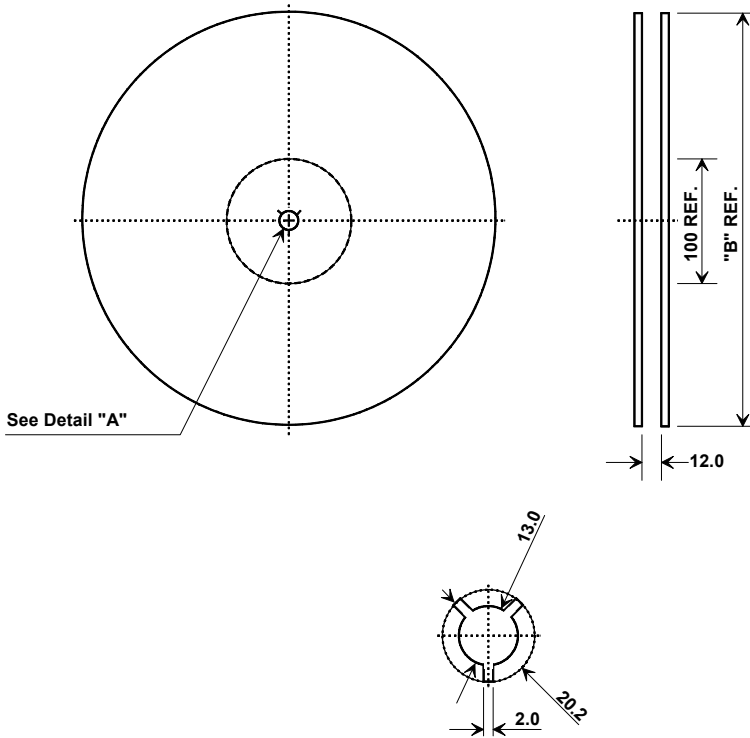

"B "		Quantity Per Reel
Nominal Size		
Inches	millimeters	
7	178	500
13	330	3000

COMPONENT ORIENTATION and DIMENSIONS

Carrier Tape Dimensions	
Ao	5.3 mm
Bo	5.3 mm
Ko	2.0 mm
Pitch	8.0 mm
W	12.0 mm

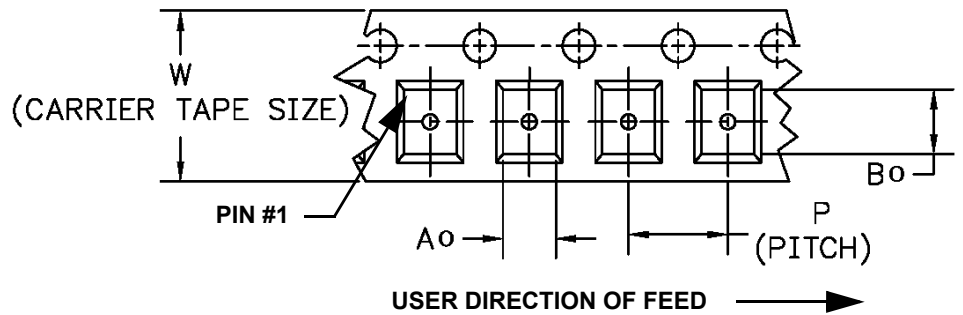
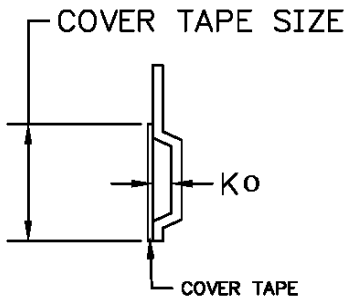

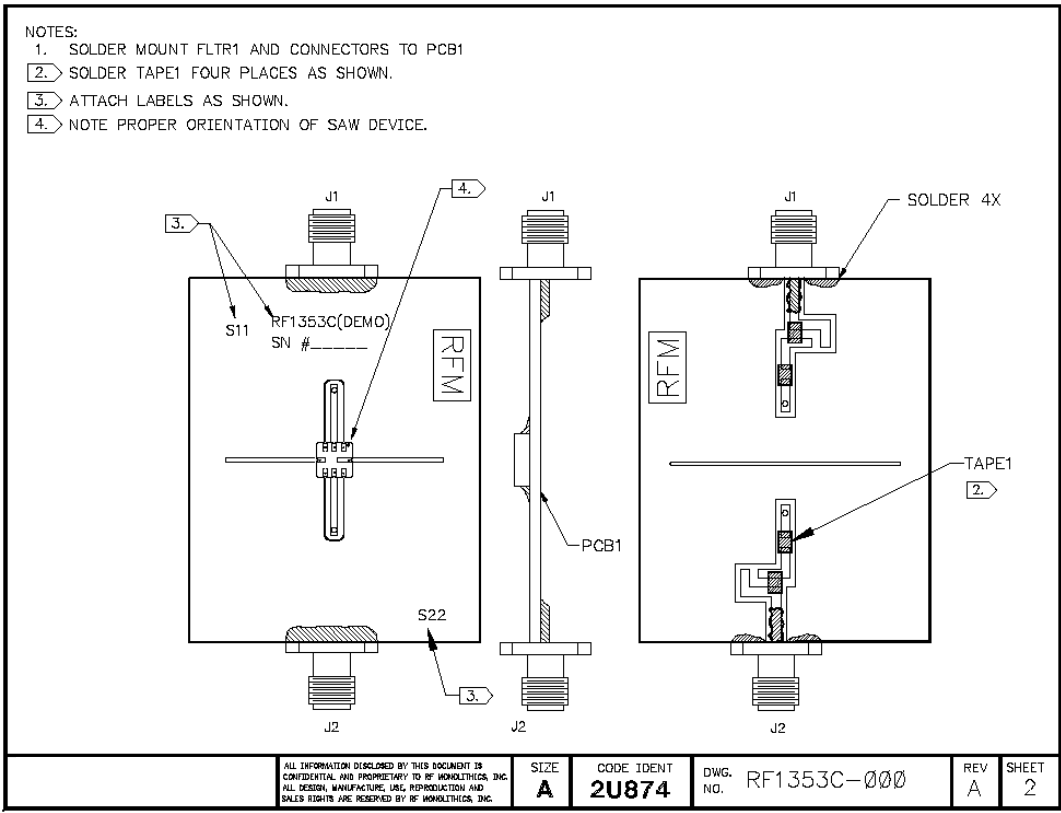
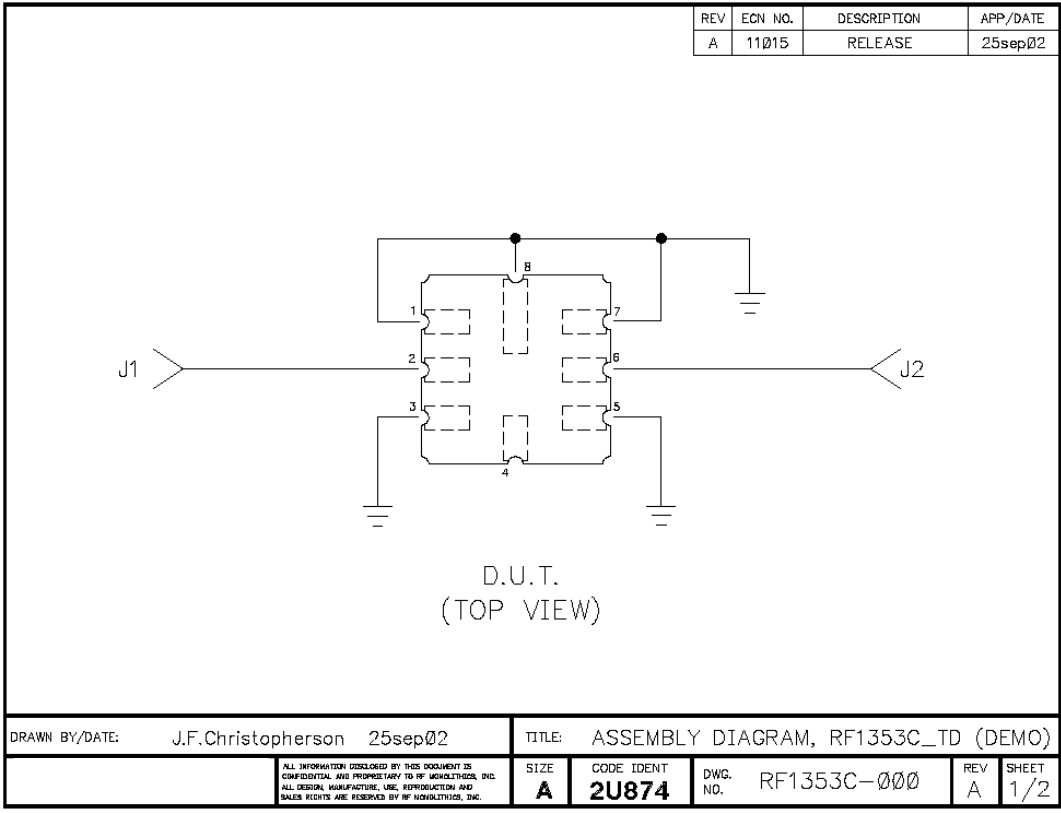

22 May 2002 13:01:48
 CH1 S21 log MAG 1 dB/ REF -4.2 dB 1 0 dB

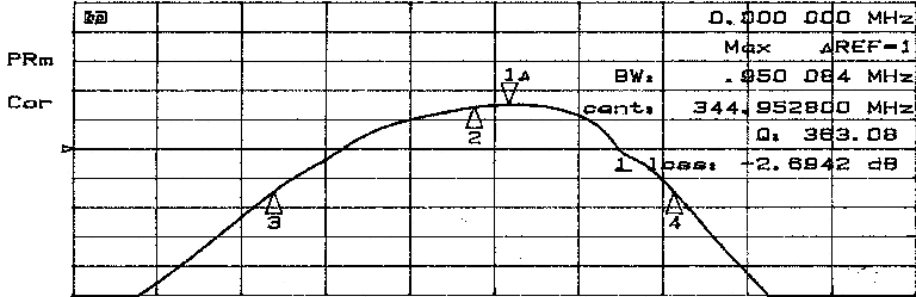

CH1 CENTER 345.000 000 MHz SPAN 2.000 000 MHz
 CH2 S21 log MAG 10 dB/ REF -2.973 dB 1 0 dB

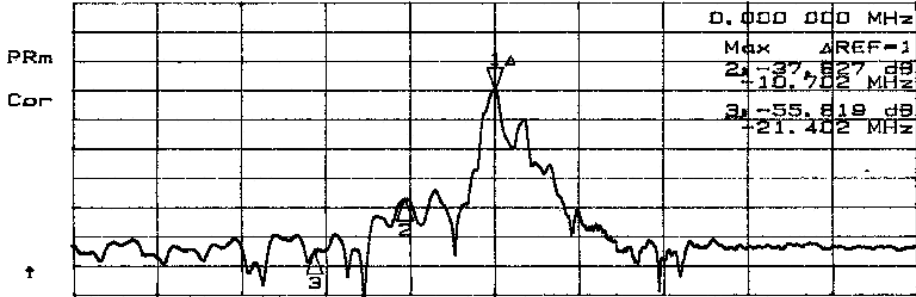

CH2 CENTER 345.000 000 MHz SPAN 100.000 000 MHz

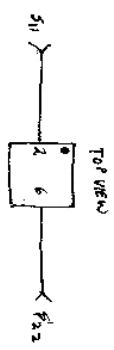

22 May 2002 13:06:59
 CH1 S11 1 U FS 1 45.432 n 4.3457 n 2.0048 nH
 345.000 000 MHz

PRm
 Cor

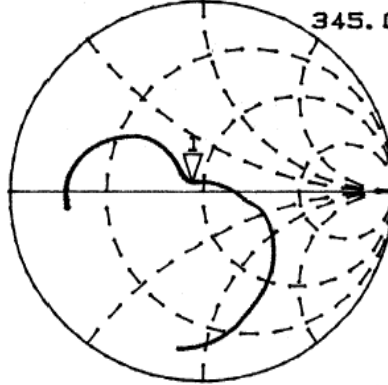

CH2 S22 1 U FS 1 46.686 n 2.0625 n 951.47 pH
 345.000 000 MHz

PRm
 Cor

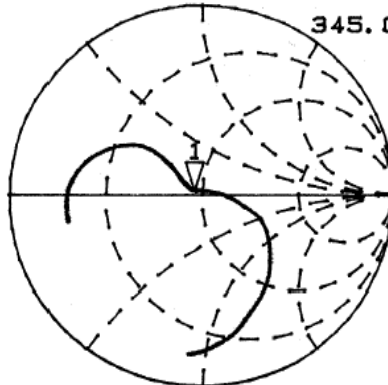

CENTER 345.000 000 MHz SPAN 2.000 000 MHz