



IMPORTANT NOTICE

Dear customer,

As from June 1st, 2007 NXP Semiconductors has acquired the LH7xxx ARM Microcontrollers from Sharp Microelectronics. The following changes are applicable to the attached data sheet. In data sheets where the previous Sharp or Sharp Corporation references remain, please use the new links as shown below.

For www.sharpsma.com use www.nxp.com/microcontrollers

for indicated sales addresses use salesaddresses@nxp.com (email)

The copyright notice at the bottom of each page (or elsewhere in the document, depending on the version)

- Copyright © (year) by SHARP Corporation.

is replaced with:

- © NXP B.V. (year). All rights reserved.

If you have any questions related to the data sheet, please contact our nearest sales office via e-mail or phone (details via salesaddresses@nxp.com). Thank you for your cooperation and understanding, In addition to that the Annex A (attached hereto) is added to the document.

NXP Semiconductors

Product data sheet

FEATURES

- Highly Integrated System-on-Chip
- High Performance (77.4144 MHz CPU Speed)
- ARM720T™ RISC Core
 - 32-bit ARM7TDMI™ RISC Core
 - 8 kB Cache
 - MMU (Windows CE™ Enabled)
 - Write Buffer
- 32 kB On-Chip SRAM
- Flexible, Programmable Memory Interface
 - SDRAM Interface
 - 15-bit External Address Bus
 - 32-bit External Data Bus
 - Two Segments (128 MB each)
 - SRAM/Flash/ROM Interface
 - 26-bit External Address Bus
 - 32-bit External Data Bus
 - Seven Segments (64 MB Each)
- Multi-stream DMA Controller
 - Four 32-bit Burst-based Data Streams
- Clock and Power Management
 - 32.768 kHz Oscillator for Real Time Clock
 - 14.7456 MHz Oscillator and On-chip PLL for CPU and Bus Clocks
 - Active, Standby, Sleep and Stop Power Modes
 - Externally-supplied Clock Options
- Low Power Modes
 - Active Mode: 55 mA (MAX.)
 - Standby Mode: 35 mA (MAX.)
 - Sleep Mode: 5.5 mA (MAX.)
 - Stop Mode 2: 18 μ A
- Watchdog Timer
- Vectored Interrupt Controller
 - 16 Standard and 16 Vectored IRQ Interrupts
 - Hardware Interrupt Priority
 - Software Interrupts
 - FIQ Fast Interrupts
- Three UARTs
 - 16-byte FIFOs for Rx and Tx
 - IrDA SIR Support
 - Supports Data Rates Up to 460.8 kb/s
- Two 16-bit Pulse Width Modulators
- Two Dual Channel Timer Modules
- Real Time Clock
 - 32-bit Up-counter with Programmable Load
 - Programmable 32-bit Match Compare Register
- 64 Programmable General Purpose I/O Signals
 - Multiplexed with Peripheral I/O Signals
- Programmable Color LCD Controller
 - Up to 800 x 600 Resolution
 - Supports STN, Color STN, AD-TFT, TFT
 - Supports 15 Shades of Gray
 - TFT: Supports 64 k Direct Colors or 256 Colors selected from a Palette of 64,000 Colors
 - Color STN: Supports 3,375 Direct Colors or 256 Colors Selected from a Palette of 3,375 Colors
- Synchronous Serial Port
 - Supports Data Rates Up to 1.8452 Mb/s
 - Compatible with Common Interface Schemes
 - Motorola SPI™
 - National Semiconductor MICROWIRE™
 - Texas Instruments SSI
- JTAG Debug Interface and Boundary Scan
- 5 V Tolerant Digital I/O
 - XTALIN and XTAL32IN inputs are 1.8 V \pm 10 %

DESCRIPTION

The LH79520, powered by an ARM720T, is a complete System-on-Chip with a high level of integration to satisfy a wide range of requirements and expectations. The LH79520 combines a 32-bit ARM720T RISC, Color LCD controller, Cache, Local SRAM, a number of essential peripherals such as Direct Memory Access, Serial and Parallel Interfaces, Infrared support, Timers, Real Time Clock, Watchdog Timer, Pulse Width Modulators, and an on-chip Phase Lock Loop. Debug is made simple by JTAG support.

This high level of integration lowers overall system costs, reduces development cycle time and accelerates product introduction. The LH79520's fully static design, power management unit, low voltage operation (1.8 V Core, 3.3 V I/O), on-chip PLL, fast interrupt response time, on-chip cache and SRAM, powerful instruction set, and low power RISC core provide high performance.

To build an advanced portable device, advanced processing capability is required. This capability must come with increased performance in the display system and peripherals, and yet demand less power from batteries. The LH79520 is an integrated solution to fit these needs.

ORDERING INFORMATION**Table 1. Ordering information**

Type number	Package		Version
	Name	Description	
LH79520N0Q000B1	LQFP176	plastic low profile quad flat package; 176 leads; body 20 x 20 x 1.4 mm	SOT1017-1

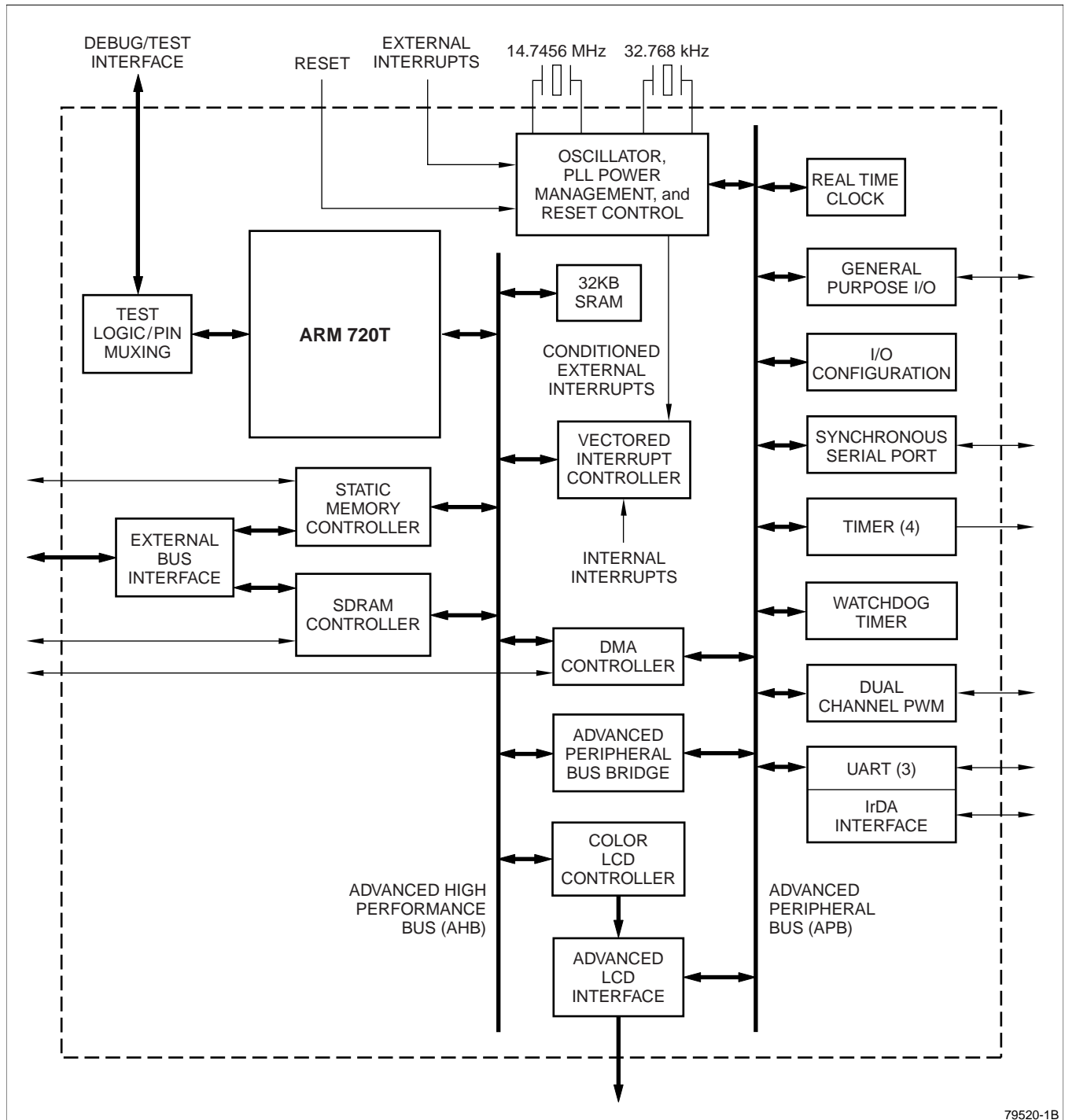

79520-1B

Figure 1. LH79520 block diagram

PIN CONFIGURATION

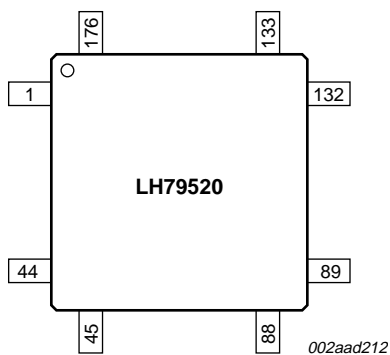

Figure 2. LH79520 pin configuration

SIGNAL DESCRIPTIONS

Table 2. LH79520 Signal Descriptions

PIN NO.	SIGNAL NAME	TYPE	DESCRIPTION	NOTES
MEMORY INTERFACE (MI)				
2-7 9-12 14-17 19-22 24-27 29-32	A[25:0]	Output	Address Signals	
50-54 56-63 65-66 67-69 71-74 76-79 81-84 86-87	D[31:0]	Input/Output	Data Input/Output Signals	1
101	SDCLK	Output	SDRAM Clock	1
109	DQM3	Output	Data Mask Output to SDRAMs	1
110	DQM2	Output	Data Mask Output to SDRAMs	1
111	DQM1	Output	Data Mask Output to SDRAMs	1
112	DQM0	Output	Data Mask Output to SDRAMs	1
102	SDCKE	Output	SDRAM Clock Enable	1
104	nDCS1	Output	SDRAM Chip Select	1
105	nDCS0	Output	SDRAM Chip Select	1
107	nRAS	Output	Row Address Strobe	
108	nCAS	Output	Column Address Strobe	
106	nSDWE	Output	SDRAM Write Enable	1
41	nCS6	Output	Static Memory Controller Chip Select	1
42	nCS5	Output	Static Memory Controller Chip Select	1
43	nCS4	Output	Static Memory Controller Chip Select	1
44	nCS3	Output	Static Memory Controller Chip Select	1
46	nCS2	Output	Static Memory Controller Chip Select	
47	nCS1	Output	Static Memory Controller Chip Select	
48	nCS0	Output	Static Memory Controller Chip Select	
38	nOE	Output	Static Memory Controller Output Enable	
34	nBLE3	Output	Static Memory Controller Byte Lane Enable / Byte Write Enable	1
35	nBLE2	Output	Static Memory Controller Byte Lane Enable / Byte Write Enable	1
36	nBLE1	Output	Static Memory Controller Byte Lane Enable / Byte Write Enable	
37	nBLE0	Output	Static Memory Controller Byte Lane Enable / Byte Write Enable	
39	nWE	Output	Static Memory Controller Write Enable	
144	nWAIT	Input	Static Memory Controller External Wait Control	1, 3
DMA CONTROLLER (DMAC)				
148	DEOT0	Output	DMA 0 End of Transfer	1
147	nDACK0	Output	DMA 0 Acknowledge	1
146	DREQ0	Input	DMA 0 Request	1
157	DEOT1	Output	DMA 1 End of Transfer	1
145	DACK1	Output	DMA 1 Acknowledge	1
144	DREQ1	Input	DMA 1 Request	1, 3

Table 2. LH79520 Signal Descriptions (Cont'd)

PIN NO.	SIGNAL NAME	TYPE	DESCRIPTION	NOTES
COLOR LCD CONTROLLER (CLCDC)				
130 132 139 140 141 142 114 115 116 117 118 119 121 122 123 124 126 127	LCDVD[17:0]	Output	LCD Panel Data bus	1
137	LCDENAB	Output	LCD Data Enable	1
129	LCDFP	Output	Frame Pulse (STN), Vertical Synchronization Pulse (TFT)	1
131	LCDLP	Output	Line Synchronization Pulse (STN), Horizontal Synchronization Pulse (TFT)	1
133	LCDDCLK	Output	LCD Panel Data Clock	1
134	LCDDCLKIN	Input	LCD External Clock Input	1
135	LCDVDDEN	Output	LCD Digital Supply Enable	1
135	LCDCLS	Output	LCD Clock Signal for Gate Driver (AD-TFT, HR-TFT only)	1
129	LCDSPS	Output	LCD Reset Signal for Row Display (AD-TFT, HR-TFT only)	1
142	LCDREV	Output	LCD Reverse Signal (AD-TFT, HR-TFT only)	1
137	LCDSPL	Output	LCD Line Start Pulse (Left) (AD-TFT, HR-TFT only)	1
119	LCDPS	Output	LCD Power Save (AD-TFT, HR-TFT only)	1
SYNCHRONOUS SERIAL PORT (SSP)				
164	SSPFRM	Output	SSP Serial Frame Output	1
165	SSPCLK	Output	SSP Clock	1
166	SSPEN	Output	SSP Data Enable	1
167	SSPTX	Output	SSP Data Out	1
169	SSPRX	Input	SSP Data In	1
PULSE WIDTH MODULATOR (PWM)				
150	PWM0	Output	PWM0 Output	1
151	PWMSYNC0	Input	PWM0 Synchronizing Input	1
157	PWM1	Output	PWM1 Output	1
UART0 (U0)				
163	UARTRX0	Input	UART0 Received Serial Data Input	1
162	UARTTX0	Output	UART0 Transmitted Serial Data Output	1
163	UARTIRRX0	Input	UART0 InfraRed Receive	1
162	UARTIRTX0	Output	UART0 InfraRed Transmit	1

Table 2. LH79520 Signal Descriptions (Cont'd)

PIN NO.	SIGNAL NAME	TYPE	DESCRIPTION	NOTES
UART1 (U1)				
160	UARTRX1	Input	UART1 Received Serial Data Input	1
159	UARTTX1	Output	UART1 Transmitted Serial Data Output	1
UART2 (U2)				
169	UARTRX2	Input	UART2 Received Serial Data Input	1
167	UARTTX2	Output	UART2 Transmitted Serial Data Output	1
GENERAL PURPOSE INPUT/OUTPUT (GPIO)				
153 155 156 159 160 164 165 166	PA7 PA6 PA5 PA4 PA3 PA2 PA1 PA0	Input/Output	General Purpose I/O Signals - Port A	1
139 140 141 142 146 147 148 152	PB7 PB6 PB5 PB4 PB3 PB2 PB1 PB0	Input/Output	General Purpose I/O Signals - Port B	1
129 130 131 132 133 134 135 137	PC7 PC6 PC5 PC4 PC3 PC2 PC1 PC0	Input/Output	General Purpose I/O Signals - Port C	1
116 117 118 119 121 122 123 124	PD7 PD6 PD5 PD4 PD3 PD2 PD1 PD0	Input/Output	General Purpose I/O Signals - Port D	1
102 104 105 106 109 110 111 112	PE7 PE6 PE5 PE4 PE3 PE2 PE1 PE0	Input/Output	General Purpose I/O Signals - Port E	1
61 62 63 65 66 67 99 101	PF7 PF6 PF5 PF4 PF3 PF2 PF1 PF0	Input/Output	General Purpose I/O Signals - Port F. GPIO PF1 is only available when CLKINSEL is '0' (i.e. the external clock source is not being used).	1

Table 2. LH79520 Signal Descriptions (Cont'd)

PIN NO.	SIGNAL NAME	TYPE	DESCRIPTION	NOTES
52 53 54 56 57 58 59 60	PG7 PG6 PG5 PG4 PG3 PG2 PG1 PG0	Input/Output	General Purpose I/O Signals - Port G	1
34 35 41 42 43 44 50 51	PH7 PH6 PH5 PH4 PH3 PH2 PH1 PH0	Input/Output	General Purpose I/O Signals - Port H	1
COUNTER/TIMER (C/T)				
145	CTOUT1B	Output	Counter/Timer Output	1
RESET, CLOCK, AND POWER CONTROLLER (RCPC)				
96	nRESETIN	Input	Reset Input	
97	nRESETOUT	Output	Reset Output	
114	INT7	Input	External Interrupt Input	1
115	INT6	Input	External Interrupt Input	1
144	INT5	Input	External Interrupt Input	1, 3
150	INT4	Input	External Interrupt Input	1
151	INT3	Input	External Interrupt Input	1
152	INT2	Input	External Interrupt Input	1
153	INT1	Input	External Interrupt Input	1
155	INT0	Input	External Interrupt Input	1
93	XTALIN	Input	Crystal Input	
94	XTALOUT	Output	Crystal Output	
89	XTAL32IN	Input	32.768 kHz Crystal Oscillator Input	
90	XTAL32OUT	Output	32.768 kHz Crystal Oscillator Output	
88	CLKINSEL	Input	External Clock Select	
98	CLKIN	Input	External Clock Input (if CLKINSEL = HIGH at reset)	1
99	CLKEN	Output	External Clock Enable (if CLKINSEL = LOW at reset, then this pin functions as PF1)	1
156	CLKOUT	Output	Clock Out (selectable from the internal bus clock or 32.768)	1
98	UARTCLK	Input	External UART Clock Input (with CLKSEL = LOW)	1
TEST INTERFACE				
174	nTRST	Input	JTAG Test Reset Input	
170	TMS	Input	JTAG Test Mode Select Input	
173	TCLK	Input	JTAG Test Clock Input	
172	TDI	Input	JTAG Test Serial Data Input	
171	TDO	Output	JTAG Test Data Serial Output	
175	TEST1	Input	Tie LOW for Normal Operation (has internal pull-down).	
176	TEST2	Input	JTAG Debug Enable: Tie LOW for Normal Operation; pull HIGH to enable JTAG Debugging (has internal pull-down).	
1	nTSTA	Input	Tie HIGH for Normal Operation (has internal pull-up).	

Table 2. LH79520 Signal Descriptions (Cont'd)

PIN NO.	SIGNAL NAME	TYPE	DESCRIPTION	NOTES
POWER AND GROUND (GND)				
40 75 95 113 136 154	VDDC	Power	Core Power Supply	
45 120 138 158	VSSC	Ground	Core GND	
8 18 28 49 64 85 100 125 143 161	VDD	Power	Input/Output Power Supply	
13 23 33 55 70 80 103 128 149 168	VSS	Ground	Input/Output GND	
91	VDDA	Power	Analog Power Supply for PLLs and XTAL Oscillators	
92	VSSA	Ground	Analog GND for PLLs and XTAL Oscillators	

NOTES:

1. These pin numbers have multiplexed functions.
2. Signals preceded by 'n' are Active LOW.
3. Immediately after reset, pin 144 can be programmed to function as INT5, DREQ1 or both. Software should avoid enabling both of these functions simultaneously. Pin 144 can also be programmed to function as nWAIT, rendering the INT5/DREQ1 choice unavailable.

NUMERICAL PIN LIST

Table 3. LH79520 Numerical Pin List

PIN NO.	FUNCTION AT RESET	FUNCTION 2	FUNCTION 3	TYPE ⁵	OUTPUT DRIVE ⁷	NOTES
1	nTSTA			Input	None	1
2	A25			Output	8 mA	
3	A24			Output	8 mA	
4	A23			Output	8 mA	
5	A22			Output	8 mA	
6	A21			Output	8 mA	
7	A20			Output	8 mA	
8	VDD			Power	None	
9	A19			Output	8 mA	
10	A18			Output	8 mA	
11	A17			Output	8 mA	
12	A16			Output	8 mA	
13	VSS			Ground	None	
14	A15			Output	8 mA	
15	A14			Output	8 mA	
16	A13			Output	8 mA	
17	A12			Output	8 mA	
18	VDD			Power	None	
19	A11			Output	8 mA	
20	A10			Output	8 mA	
21	A9			Output	8 mA	
22	A8			Output	8 mA	
23	VSS			Ground	None	
24	A7			Output	8 mA	
25	A6			Output	8 mA	
26	A5			Output	8 mA	
27	A4			Output	8 mA	
28	VDD			Power	None	
29	A3			Output	8 mA	
30	A2			Output	8 mA	
31	A1			Output	8 mA	
32	A0			Output	8 mA	
33	VSS			Ground	None	
34	PH7	nBLE3		I/O	8 mA	
35	PH6	nBLE2		I/O	8 mA	
36	nBLE1			Output	8 mA	
37	nBLE0			Output	8 mA	
38	nOE			Output	8 mA	

Table 3. LH79520 Numerical Pin List (Cont'd)

PIN NO.	FUNCTION AT RESET	FUNCTION 2	FUNCTION 3	TYPE ⁵	OUTPUT DRIVE ⁷	NOTES
39	nWE			Output	8 mA	
40	VDDC			Power	None	
41	PH5	nCS6		I/O	8 mA	
42	PH4	nCS5		I/O	8 mA	
43	PH3	nCS4		I/O	8 mA	
44	PH2	nCS3		I/O	8 mA	
45	VSSC			Ground	None	
46	nCS2			Output	8 mA	
47	nCS1			Output	8 mA	
48	nCS0			Output	8 mA	
49	VDD			Power	None	
50	PH1	D31		I/O	8 mA	
51	PH0	D30		I/O	8 mA	
52	PG7	D29		I/O	8 mA	
53	PG6	D28		I/O	8 mA	
54	PG5	D27		I/O	8 mA	
55	VSS			Ground	None	
56	PG4	D26		I/O	8 mA	
57	PG3	D25		I/O	8 mA	
58	PG2	D24		I/O	8 mA	
59	PG1	D23		I/O	8 mA	
60	PG0	D22		I/O	8 mA	
61	PF7	D21		I/O	8 mA	
62	PF6	D20		I/O	8 mA	
63	PF5	D19		I/O	8 mA	
64	VDD			Power	None	
65	PF4	D18		I/O	8 mA	
66	PF3	D17		I/O	8 mA	
67	PF2	D16		I/O	8 mA	
68	D15			I/O	8 mA	
69	D14			I/O	8 mA	
70	VSS			Ground	None	
71	D13			I/O	8 mA	
72	D12			I/O	8 mA	
73	D11			I/O	8 mA	
74	D10			I/O	8 mA	
75	VDDC			Power	None	
76	D9			I/O	8 mA	
77	D8			I/O	8 mA	

Table 3. LH79520 Numerical Pin List (Cont'd)

PIN NO.	FUNCTION AT RESET	FUNCTION 2	FUNCTION 3	TYPE ⁵	OUTPUT DRIVE ⁷	NOTES
78	D7			I/O	8 mA	
79	D6			I/O	8 mA	
80	VSS			Ground	None	
81	D5			I/O	8 mA	
82	D4			I/O	8 mA	
83	D3			I/O	8 mA	
84	D2			I/O	8 mA	
85	VDD			Power	None	
86	D1			I/O	8 mA	
87	D0			I/O	8 mA	
88	CLKINSEL			Input	None	2
89	XTAL32IN			Input	None	8
90	XTAL32OUT			Output		3
91	VDDA			Power	None	
92	VSSA			Ground	None	
93	XTALIN			Input	None	8
94	XTALOUT			Output		3
95	VDDC			Power	None	
96	nRESETIN			Input	None	1, 4
97	nRESETOUT			Output	4 mA	
98	CLKIN	UARTCLK		Input	None	
99	PF1	CLKEN		I/O	2 mA	
100	VDD			Power	None	
101	PF0	SDCLK		I/O	8 mA	
102	PE7	SDCKE		I/O	8 mA	
103	VSS			Ground	None	
104	PE6	nDCS1		I/O	8 mA	
105	PE5	nDCS0		I/O	8 mA	
106	PE4	nSDWE		I/O	8 mA	
107	nRAS			Output	8 mA	
108	nCAS			Output	8 mA	
109	PE3		DQM3	I/O	8 mA	
110	PE2		DQM2	I/O	8 mA	
111	PE1		DQM1	I/O	8 mA	
112	PE0		DQM0	I/O	8 mA	
113	VDDC			Power	None	
114	INT7	LCDVD11		I/O	8 mA	4
115	INT6	LCDVD10		I/O	8 mA	4
116	PD7	LCDVD9		I/O	8 mA	

Table 3. LH79520 Numerical Pin List (Cont'd)

PIN NO.	FUNCTION AT RESET	FUNCTION 2	FUNCTION 3	TYPE ⁵	OUTPUT DRIVE ⁷	NOTES
117	PD6	LCDVD8		I/O	8 mA	
118	PD5	LCDVD7		I/O	8 mA	
119	PD4	LCDVD6	LCDPS	I/O	8 mA	
120	VSSC			Ground	None	
121	PD3	LCDVD5		I/O	8 mA	
122	PD2	LCDVD4		I/O	8 mA	
123	PD1	LCDVD3		I/O	8 mA	
124	PD0	LCDVD2		I/O	8 mA	
125	VDD			Power	None	
126	LCDVD1			Output	8 mA	
127	LCDVD0			Output	8 mA	
128	VSS			Ground	None	
129	PC7	LCDFP	LCDSPL	I/O	8 mA	
130	PC6	LCDVD17		I/O	8 mA	
131	PC5	LCDLP		I/O	8 mA	
132	PC4	LCDVD16		I/O	8 mA	
133	PC3	LCDDCLK		I/O	8 mA	
134	PC2	LCDDCLKIN		I/O	2 mA	
135	PC1	LCDVDDEN	LCDCLS	I/O	8 mA	
136	VDDC			Power	None	
137	PC0	LCDENAB	LCDSPL	I/O	8 mA	
138	VSSC			Ground	None	
139	PB7	LCDVD15		I/O	8 mA	
140	PB6	LCDVD14		I/O	8 mA	
141	PB5	LCDVD13		I/O	8 mA	
142	PB4	LCDVD12	LCDREV	I/O	8 mA	
143	VDD			Power	None	
144	INT5/DREQ1	nWAIT		Input	None	4, 6
145	CTOUT1B	DACK1		Output	4 mA	
146	PB3	DREQ0		I/O	2 mA	4
147	PB2	nDACK0		I/O	4 mA	
148	PB1	DEOT0		I/O	4 mA	
149	VSS			Ground	None	
150	INT4	PWM0		I/O	4 mA	4
151	INT3	PWMSYNC0		Input	None	4
152	PB0	INT2		I/O	2 mA	4
153	PA7	INT1		I/O	2 mA	4
154	VDDC			Power	None	
155	PA6	INT0		I/O	2 mA	4

Table 3. LH79520 Numerical Pin List (Cont'd)

PIN NO.	FUNCTION AT RESET	FUNCTION 2	FUNCTION 3	TYPE ⁵	OUTPUT DRIVE ⁷	NOTES
156	PA5	CLKOUT		I/O	8 mA	
157	PWM1	DEOT1		Output	4 mA	
158	VSSC			Ground	None	
159	PA4	UARTTX1		I/O	4 mA	
160	PA3	UARTRX1		I/O	2 mA	4
161	VDD			Power	None	
162	UARTIRTX0	UARTTX0		Output	4 mA	
163	UARTIRRX0	UARTRX0		Input	None	4
164	PA2	SSPFRM		I/O	4 mA	
165	PA1	SSPCLK		I/O	4 mA	
166	PA0	SSPEN		I/O	4 mA	
167	SSPTX	UARTTX2		Output	4 mA	
168	VSS			Ground	None	
169	SSPRX	UARTRX2		Input	None	4
170	TMS			Input	None	1, 4
171	TDO			Output	4 mA	
172	TDI			Input	None	1, 4
173	TCLK			Input	None	
174	nTRST			Input	None	1, 4
175	TEST1			Input	None	2
176	TEST2			Input	None	2

NOTES:

1. Input with internal pull-up.
2. Input with internal pull-down.
3. Output is for crystal oscillator only, no drive capability.
4. Input with Schmitt Trigger.
5. I/O = Input/Output.
6. Software should avoid enabling the INT5 and DREQ1 functions simultaneously.
7. Output Drive Values shown are MAX. See 'DC Specifications'.
8. Crystal Oscillator Inputs should be driven to a maximum of $1.8\text{ V} \pm 10\%$.

Table 4. LCD Data Multiplexing

PIN NO.	LCD DATA SIGNAL	STN						ALL TFT: 5:5:5+1	ALL TFT: 5:6:5	ALL TFT: PALETTE DATA OR 16-BIT DIRECT
		MONO 4-BIT		MONO 8-BIT		COLOR				
		SINGLE PANEL	DUAL PANEL	SINGLE PANEL	DUAL PANEL	SINGLE PANEL	DUAL PANEL			
130	LCDVD17							BLUE4	BLUE3	BIT 14
132	LCDVD16							BLUE3	BLUE2	BIT 13
139	LCDVD15				MLSTN7		CLSTN7	BLUE2	BLUE1	BIT 12
140	LCDVD14				MLSTN6		CLSTN6	BLUE1	BLUE0	BIT 11
141	LCDVD13				MLSTN5		CLSTN5	BLUE0	GREEN5	BIT 10
142	LCDVD12				MLSTN4		CLSTN4			
114	LCDVD11		MLSTN3		MLSTN3		CLSTN3	GREEN4	GREEN4	BIT 9
115	LCDVD10		MLSTN2		MLSTN2		CLSTN2	GREEN3	GREEN3	BIT 8
116	LCDVD9		MLSTN1		MLSTN1		CLSTN1	GREEN2	GREEN2	BIT 7
117	LCDVD8		MLSTN0		MLSTN0		CLSTN0	GREEN1	GREEN1	BIT 6
118	LCDVD7			MUSTN7	MUSTN7	CUSTN7	CUSTN7	GREEN0	GREEN0	BIT 5
119	LCDVD6			MUSTN6	MUSTN6	CUSTN6	CUSTN6			
121	LCDVD5			MUSTN5	MUSTN5	CUSTN5	CUSTN5	RED4	RED4	BIT 4
122	LCDVD4			MUSTN4	MUSTN4	CUSTN4	CUSTN4	RED3	RED3	BIT 3
123	LCDVD3	MUSTN3	MUSTN3	MUSTN3	MUSTN3	CUSTN3	CUSTN3	RED2	RED2	BIT 2
124	LCDVD2	MUSTN2	MUSTN2	MUSTN2	MUSTN2	CUSTN2	CUSTN2	RED1	RED1	BIT 1
126	LCDVD1	MUSTN1	MUSTN1	MUSTN1	MUSTN1	CUSTN1	CUSTN1	RED0	RED0	BIT 0
127	LCDVD0	MUSTN0	MUSTN0	MUSTN0	MUSTN0	CUSTN0	CUSTN0	Intensity ⁶	BLUE4	BIT 15

NOTES:

1. The Intensity bit is identically generated for all three colors.
2. MUSTN = Monochrome Upper data bit for STN panel.
3. MLSTN = Monochrome Lower data bit for STN panel.
4. CUSTN = Color Upper data bit for STN panel.
5. CLSTN = Color Lower data bit for STN panel.
6. Connect to the LSB of the Red, Green, and Blue inputs of a 6:6:6 panel.
7. Recommended hookups for TFT 5:5:5 + Intensity and 5:6:5 are shown.
This wiring requires the BGR bit in the LCD Control Register to be 0.

Table 5. LCD Control and Timing Signals

PIN	STN AND TFT	AD-TFT, HR-TFT	DESCRIPTION
119		LCDPS	Power Save (AD-TFT, HR-TFT only)
129	LCDFP	LCDSPL	Frame Pulse (STN), Vertical Synchronization Pulse (TFT) /Row Display Reset
131	LCDLP	LCDLP	Line Synchronization Pulse (STN), Horizontal Synchronization Pulse (TFT)
133	LCDDCLK	LCDDCLK	Panel Data Clock
134	LCDDCLKIN	LCDDCLKIN	External Clock Input
135	LCDVDDEN	LCDCLS	Digital Supply Enable/Gate Driver Clock
137	LCDENAB	LCDSPL	Data Enable/ Line Start Pulse (Left)
142		LCDREV	Reverse Signal (AD-TFT, HR-TFT only)

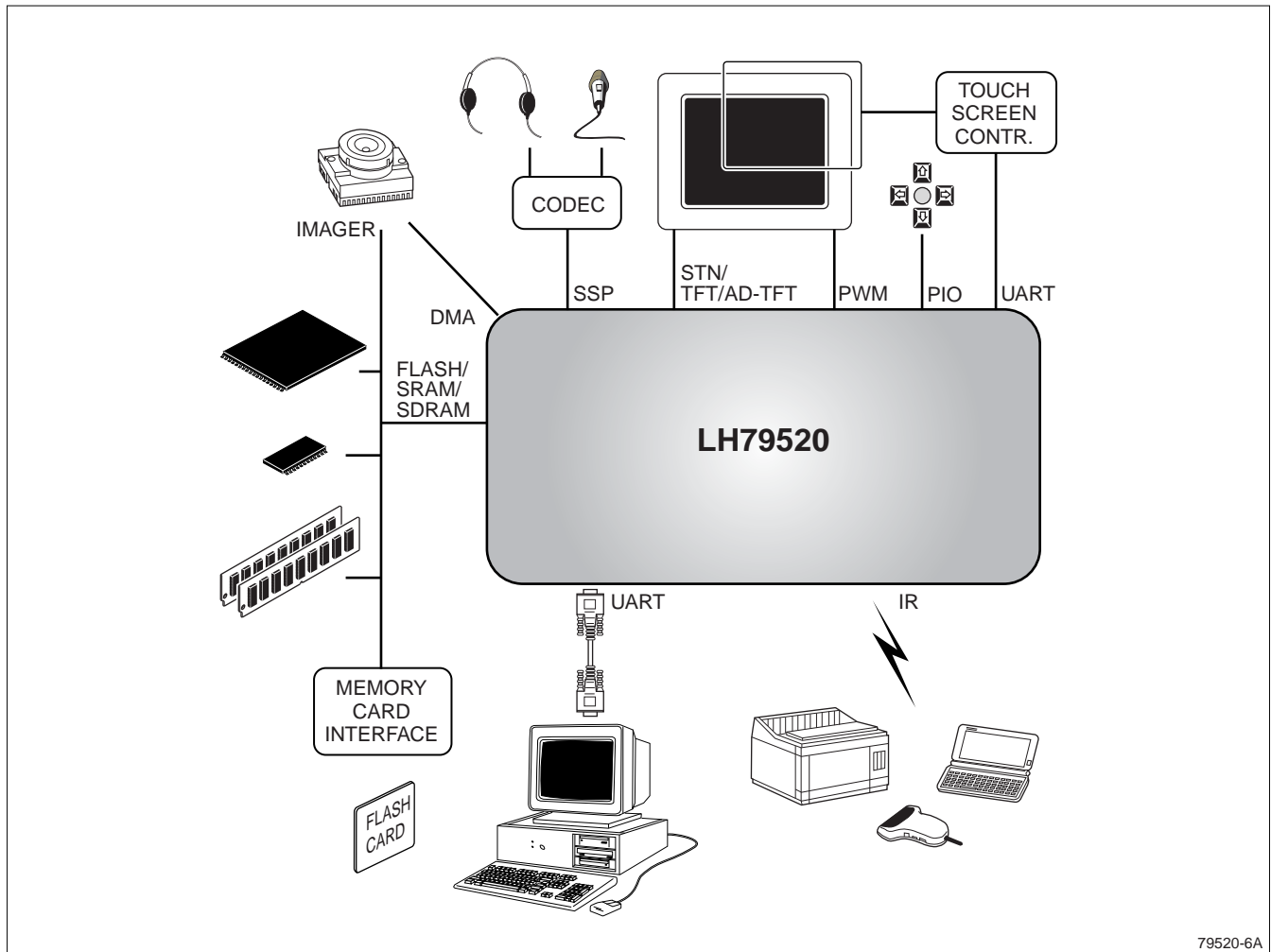

Figure 3. LH79520 Application Diagram Example

SYSTEM DESCRIPTIONS

ARM720T Processor

The LH79520 microcontroller features the ARM720T cached core with an Advanced High-Performance Bus (AHB) interface. The ARM720T features:

- 32-bit ARM7TDMI™ RISC Core
- 8 kB Cache
- MMU (Windows CE enabled)

The processor is a member of the ARM7T family of processors. For more information, see the ARM document, 'ARM720T (Rev 3) Technical Reference Manual', available on NXP's website at www.nxp.com.

The LH79520 MMU provides a means to map Physical Memory (PA) addresses to virtual memory addresses. This allows physical memory, which is con-

strained by hardware to specific addresses, to be reorganized at addresses identified by the user. These user identified locations are called Virtual Addresses (VA). When the MMU is enabled, Code and Data must be built, loaded, and executed using Virtual Addresses which the MMU translates to Physical Addresses. In addition, the user may implement a memory protection scheme by using the features of the MMU. Address translation and memory protection services provided by the MMU are controlled by the user. The MMU is directly controlled through the System Control Coprocessor, Coprocessor 15 (CP15). The MMU is indirectly controlled by a Translation Table (TT) and Page Tables (PT) prepared by the user and established using a portion of physical memory dedicated by the user to storing the TT and PT's.

Memory Architecture

An integrated SDRAM Controller and Static Memory Controller provide a glueless interface to external SDRAM, Flash, SRAM, ROM, and burst ROM. Three remap options for the physical memory are selectable by software, as shown in Figures 4, 5, and 6. Memory is exclusively Little Endian.

SDRAM CONTROLLER

The SDRAM Controller provides the interface between the internal bus and external (off-chip) SDRAM memory devices (Figure 2).

The SDRAM Controller provides the following features:

- Two independently controlled chip selects.
- Transfers data between the controller and SDRAM in quad-word bursts.
- Supports both 32-bit and 16-bit SDRAM.
- Supports 2K, 4K, and 8K row address memory parts, i.e. typical 256M, 128M, 64M, and 16M parts, with 8, 16, or 32 DQ bits per device.
- Two reset domains allow SDRAM contents to be preserved over a soft reset.

STATIC MEMORY CONTROLLER (SMC)

The SMC provides the interface between the internal bus and external (off-chip) memory devices.

The LH79520 boots from 16-bit memory. The SMC address space is divided into eight memory banks of 64 MB each. The SMC supports:

- Static Memory-mapped Devices including RAM, ROM, Flash, and Burst ROM
- Asynchronous Operations:
 - Page Mode Reads for non-clocked memory
 - Burst Mode Reads for burst mode ROM
- 8-, 16-, and 32-bit wide external memory data paths
- Independent configuration for up to eight memory banks, each up to 64 MB
- Programmable Parameters:
 - WAIT States (up to 32)
 - Bus Turnaround Cycles (1 to 16)
 - Initial and Subsequent Burst Read WAIT State for Burst ROM Devices.

The Static Memory Controller (SMC) also supports an nWAIT input that can be used by an external device to vary the wait time.

DMA Controller

The DMA Controller provides support for DMA-capable peripherals. The LCD controller uses its own DMA port, connecting directly to memory for retrieving display data.

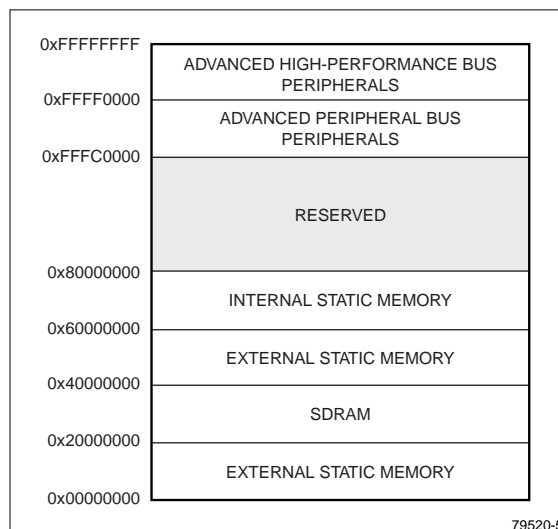

Figure 4. Memory Remap '00' and '11'

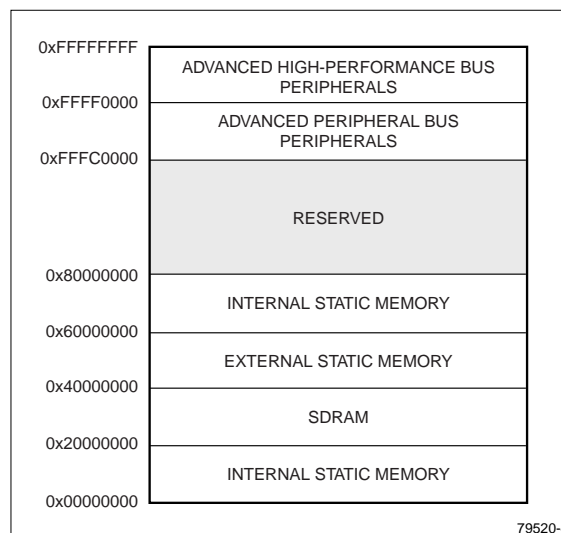

Figure 5. Memory Remap '10'

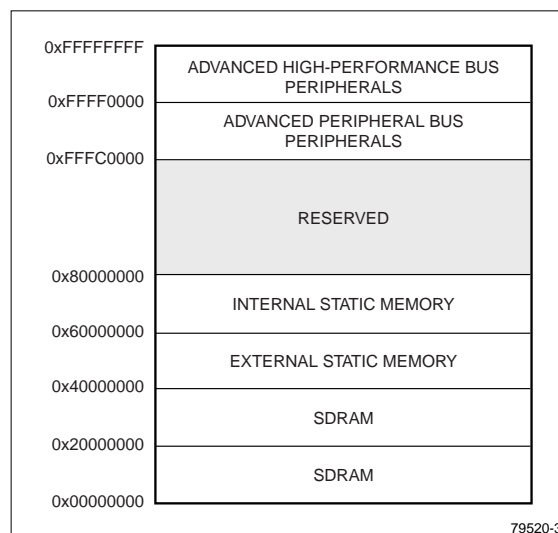

Figure 6. Memory Remap '01'

- Simultaneous servicing of up to 4 data streams
- Three transfer modes are supported:
 - Memory to Memory
 - Peripheral to Memory
 - Memory to Peripheral
- Identical source and destination capabilities
- Transfer Size Programmable (Byte, Half-word, Word)
- Burst Size Programmable
- Address Increment or Address Freeze
- Transfer Error indication for each stream via an interrupt
- 16-word FIFO array with pack and unpack logic

Handles all combinations of byte, half-word or word transfers from input to output.

Color LCD Controller (CLCDC)

The CLCDC provides all the necessary control and drive signals to interface directly with a variety of color and monochrome LCD panels.

- Supports single and dual scan color and monochrome Super Twisted Nematic (STN) displays with 4- or 8-bit interfaces
- Supports Thin Film Transistor (TFT) color displays
- Programmable resolution up to 800 × 600
 - 800 × 600 (16-bit color can only be supported at ≤ 65 Hz refresh rates with 800 × 600 resolution).
- 15 gray-level mono, 3,375 color STN, and 64 k color TFT support
- 1, 2, or 4 bits-per-pixel (BPP) for monochrome STN
- 1-, 2-, 4-, or 8-BPP palettized color displays for color STN and TFT
- True-color non-palettized, for color STN and TFT
- Programmable timing for different display panels
- 256-entry, 16-bit palette fast-access RAM
- Frame, line and pixel clock signals
- AC bias signal for STN or data enable signal for TFT panels
- Patented grayscale algorithm
- Interrupt Generation Events
- Dual 16-deep programmable 32-bit wide FIFOs for buffering incoming data.

ADVANCED LCD INTERFACE

The Advanced LCD Interface peripheral allows for direct connection to ultra-thin panels that do not include a timing ASIC. It converts TFT signals from the Color LCD controller to provide the proper signals, timing and levels for direct connection to a panel's Row and Column drivers for AD-TFT, HR-TFT, or any technology of panel that allows for a connection of this type. The

Advanced LCD Interface peripheral also provides a bypass mode that allows the LH79520 to interface to the built-in timing ASIC in standard TFT and STN panels.

Synchronous Serial Port (SSP)

The SSP is a master-only interface for synchronous serial communication with slave peripheral devices that support protocols for Motorola SPI, National Semiconductor MICROWIRE, or Texas Instruments Synchronous Serial Interface.

- Master-only operation
- Programmable clock rate
- Separate transmit FIFO and receive FIFO buffers, 16 bits wide, 8 locations deep
- DMA for transmit and receive
- Programmable interface protocols: Motorola SPI, National Semiconductor MICROWIRE, or Texas Instruments Synchronous Serial Port
- Programmable data frame size from 4 to 16 bits
- Independent masking of transmit FIFO, receive FIFO and receive overrun interrupts
- Available internal loopback test mode.

Universal Asynchronous Receiver Transmitter (UART)

The LH79520 incorporates three UARTs.

- Programmable use of UART0 or IrDA SIR input/output
- Separate 16-byte transmit and receive FIFOs to reduce CPU interrupts
- Programmable FIFO disabling for 1-byte depth
- Programmable baud rate generator
- Independent masking of transmit FIFO, receive FIFO, receive timeout and modem status interrupts
- False start bit detection
- Line Break generation and detection
- Fully-programmable serial interface characteristics:
 - 5-, 6-, 7-, or 8-bit data word length
 - Even-, odd- or no-parity bit generation and detection
 - 1 or 2 stop bit generation
- IrDA SIR Encode/Decode block, providing:
 - Programmable use of IrDA SIR or UART0 input/output
 - Supports data rates up to 115.2 Kbps half-duplex
 - Programmable internal clock generator, allowing division of the Reference clock in increments of 1 to 512 for low-power mode bit durations.

VARIATIONS FROM THE 16C550 UART

The UART varies from the industry-standard 16C550 UART device in six ways:

- Receive FIFO trigger levels are fixed at 8 bytes
- Receive errors are stored in the FIFO, and do not generate an interrupt.
- The internal register map address space and each register's bit function differ.

The following 16C550 UART features are not supported:

- 1.5 stop bits (1 or 2 stop bits only are supported)
- The forcing stick parity function
- Independent receive clock.

Pulse Width Modulator (PWM)

- Two independent output channels with separate input clocks
- Up to 16-bit resolution
- Programmable synchronous mode support
 - Allows external input to start PWM
- Programmable pulse width (duty cycle), interval (frequency), and polarity
 - Static programming: PWM is stopped
 - Dynamic programming: PWM is running
 - Updates duty cycle, frequency, and polarity at the end of a PWM cycle
 - Wide programming range.

Vectored Interrupt Controller

The Vectored Interrupt Controller combines the interrupt request signals from 20 internal and eight external interrupt sources and applies them, after masking and prioritization, to the IRQ and FIQ interrupt inputs of the ARM7TDMI processor core.

The Interrupt Controller incorporates a hardware interrupt vector logic with programmable priority for up to 16 interrupt sources. This logic reduces the interrupt response time for IRQ type interrupts compared to solutions using software polling to determine the highest priority interrupt source. This significantly improves the real-time capabilities of the LH79520 in embedded control applications.

- 20 internal and eight external interrupt sources
 - Individually maskable
 - Status accessible for software polling
- IRQ interrupt vector logic for up to 16 channels with programmable priorities
- All of the interrupt channels, with the exception of the Watchdog Timer interrupt, can be programmed to generate:

- FIQ interrupt request
- Non-vectored IRQ interrupt request (software to poll IRQ source)
- Vectored IRQ interrupt request (up to 16 channels total)
- The Watchdog timer can only generate FIQ interrupt requests
- External interrupt inputs programmable
 - Edge triggered or level triggered
 - Rising edge/active HIGH or falling edge/active LOW

The 28 interrupt channels are shown in Table 6.

Table 6. Interrupt Channels

CHANNEL	INTERRUPT SOURCE
0	External Interrupt 0
1	External Interrupt 1
2	External Interrupt 2
3	External Interrupt 3
4	External Interrupt 4
5	External Interrupt 5
6	External Interrupt 6
7	External Interrupt 7
8	Spare Internal Interrupt 0
9	COMRX (used for debug)
10	COMTX (used for debug)
11	SSP RX time-out interrupt SSPRXTO
12	CLCD Combined Interrupt
13	SSP SSPTXINTR
14	SSP SSPRXINTR
15	SSP SSPRORINTR
16	SSP SSPINTR
17	Counter/Timer0
18	Counter/Timer1
19	Counter/Timer2
20	Counter/Timer3
21	UART ch0 Rx
22	UART ch0 Tx
23	UART ch0
24	UART ch1
25	UART ch2
26	DMA Combined
27-29	Unused
30	RTC_ALARM
31	WDT

Reset, Clock, and Power Controller (RCPC)

The RCPC generates the various clock signals for the operation of the LH79520 and provides for an orderly start-up after power-on and during a wake-up from one of the power saving operating modes. The RCPC allows the software to individually select the frequency of the various on-chip clock signals as required to operate the chip in the most power-efficient mode. It features:

- 14.7456 MHz crystal oscillator and PLL for on-chip Clock generation
- External Clock input if on-chip oscillator and PLL are not used
- 32.768 kHz crystal oscillator generating 1 Hz clock for Real Time Clock
- Individually controlled clocks for peripherals and CPU
- Clock source for UARTs is selectable between 14.7456 MHz crystal oscillator and external clock source
- Programmable clock prescalers for UARTs and PWMs
- Five global power control modes are available:
 - Active
 - Standby
 - Sleep
 - Stop1
 - Stop2
- CPU and Bus clock frequency can be changed on the fly
- Selectable clock output
- Hardware reset (nRESETIN) and software reset.

The 32.768 kHz crystal oscillator is not required for chip operation, so it may be left out of the design to save power. If this crystal is not used, XTALIN should be pulled to VDD or VSS so the input does not float.

Table 7. Clock and Enable States for Different Power Modes (Using On-chip Oscillator and PLL)

FUNCTION	ACTIVE	STANDBY	SLEEP	STOP1	STOP2
14.7456 MHz Oscillator	ON	ON	ON	ON	OFF
PLL	ON	ON	ON	OFF	OFF
Peripheral Clock	ON	ON	OFF	OFF	OFF
CPU Clock	ON	OFF	OFF	OFF	OFF

Real Time Clock

The RTC can provide a basic alarm function or long time base counter. This is achieved by generating an interrupt signal after counting for a programmed number of cycles of RTC input. Counting in one-second intervals is achieved by the use of a 1 Hz clock input to the RTC.

The features of the RTC are:

- 32-bit up counter with programmable load
- Programmable 32-bit match compare register
- Software maskable interrupt when counter and compare registers are identical.

RTC input clock sources:

- PLL clock
- 32.768 kHz clock
- 1 Hz clock (default).

Watchdog Timer

The Watchdog Timer provides hardware protection against malfunctions. It is a programmable timer to be reset by software at regular intervals. Failure to reset the timer will cause a FIQ interrupt. Failure to service the FIQ interrupt will then generate a System Reset. The features of the Watchdog Timer are:

- Driven by the bus clock
- 16 programmable time-out periods: 2^{16} through 2^{31} clock cycles
- Generates a system reset (resets LH79520) or a FIQ Interrupt whenever a time-out period is reached
- Software enable, lockout, and counter-reset mechanisms add security against inadvertent writes
- Protection mechanism guards against interrupt-service failure:
 - The first WDT time-out triggers FIQ and asserts nWDFIQ status flag
 - If FIQ service routine fails to clear nWDFIQ, then the next WDT time-out triggers a soft reset.

Timer

The LH79520 incorporates two Timer modules, each comprising two 16-bit independently programmable timers. This gives a total of four independent timers.

- Each timer has two operating modes:
 - Free-running mode: After reaching 0x0000 the timer wraps around to 0xFFFF and generates an interrupt request. It continues to count down from 0xFFFF.
 - Periodic timer mode: After reaching 0x0000 the timer is automatically reloaded with its programmed value and generates an interrupt request. It continues to count down from the loaded value.
- Each timer contains a programmable pre-scaler:
 - Bus clock divided by 1, 16, or 256
- Timers can be cascaded to achieve longer timing periods
- Carry-out of higher-order timer provides clock signal for next lower order timer
- Possible timing ranges:
 - 2^{15} (single timer)
 - 2^{31} (two timers cascaded)
 - 2^{47} (three timers cascaded)
 - 2^{63} (four timers cascaded)
- Output signal of lowest order timer is externally available as CTOUT1B signal.

Input/Output Configuration System

The registers provided by the IOCON System allow the user to directly control the pin multiplexing of the device; by setting or clearing bits in a set of registers, the user can configure the LH79520 for peripheral devices.

General Purpose Input/Output (GPIO)

The LH79520 provides up to 64 bits of programmable input/output. These eight 8-bit ports are Ports A through H, and are multiplexed with other signals.

- Individually programmable input/output pins
- All I/O ports default to Input on power-up.

ELECTRICAL SPECIFICATIONS

Absolute Maximum Ratings

PARAMETER	SYMBOL	RATING	UNIT
DC Core Supply Voltage	VDDC	-0.3 to 2.4	V
DC I/O Supply Voltage	VDD	-0.3 to 4.6	V
DC Analog Supply Voltage	VDDA	-0.3 to 2.4	V
Storage Temperature	TSTG	-55 to +125	°C

NOTE: These stress ratings are only for transient conditions. Operation at or beyond absolute maximum rating conditions may affect reliability and cause permanent damage to the device.

Recommended Operating Conditions

PARAMETER	MINIMUM	TYPICAL	MAXIMUM
DC Core Supply Voltage (VDDC) ¹	1.62 V	1.8 V	1.98 V
DC I/O Supply Voltage (VDD) ¹	3.0 V	3.3 V	3.6 V
DC Analog Supply Voltage (VDDA)	1.62 V	1.8 V	1.98 V
Clock Frequency ²	10 MHz		77.4144 MHz
Commercial Operating Temperature	0°C	25°C	+70°C
Industrial Operating Temperature	-40°C	25°C	+85°C

NOTES:

1. Core Voltage should never exceed I/O Voltage after initial power up. See the section titled 'Power Supply Sequencing'.
2. Using 14.7456 MHz Input Crystal and On-Chip PLL. Functional to DC when using external clock.

DC/AC SPECIFICATIONS (COMMERCIAL)

Unless otherwise noted, all data provided under commercial DC specifications are based on 0°C to +70°C, VDDC = 1.62 V to 1.98 V, VDD = 3.0 V to 3.6 V, VDDA = 1.62 V to 1.98 V.

DC Specifications (Commercial)

SYMBOL	PARAMETER	MIN.	TYP.	MAX.	UNIT	CONDITIONS	NOTES
VIH	CMOS input HIGH voltage	2.0		5.5	V		
VIL	CMOS input LOW voltage			0.8	V		
VIT+	Positive Input threshold voltage (Schmitt trigger pins)		1.60		V		1
VIT-	Negative Input threshold voltage (Schmitt trigger pins)		1.20		V		
VHYST	Schmitt trigger hysteresis		0.40		V	VIT+ – VIT-	
VOH	CMOS output HIGH voltage	2.6			V	IOH = -50 μ A	1
	Output drive (2 mA type)	2.6			V	IOH = -2 mA	
	Output drive (4 mA type)	2.6			V	IOH = -4 mA	
	Output drive (8 mA type)	2.6			V	IOH = -8 mA	
VOL	CMOS output LOW voltage			0.4	V	IOL = 50 μ A	1
	Output drive (2 mA type)			0.4	V	IOL = 2 mA	
	Output drive (4 mA type)			0.4	V	IOL = 4 mA	
	Output drive (8 mA type)			0.4	V	IOL = 8 mA	
XTAL32IN	External Clock Input	1.62	1.8	1.98	V		2
XTALIN	External Clock Input	1.62	1.8	1.98	V		2
IIN	Input leakage current	-10		10	μ A	VIN = VDD or GND	
IOZ	Output tri-state leakage current	-10		10	μ A	VOUT = VDD or GND	
IACTIVE	Active current		43.5	55	mA		3
ISTANDBY	Standby current		27.5	35	mA		3, 4
ISLEEP	Sleep current		3.9	5.5	mA		
ISTOP1	Stop1 current		500		μ A		
ISTOP2	Stop2 current (RTC ON)		34		μ A		
ISTOP2	Stop2 current (RTC OFF)		18		μ A		
CIN	Input Capacitance			4	pF		
COUT	Output Capacitance			4	pF		
RPULL	Pull-up or Pull-down Resistance			33	K Ω		

NOTES:

- Table 2 details each pin's buffer type.
- P-P Sinusoidal; 0.0 V DC offset.
- Running Typical Application over operating range.
- Current measured with CPU stopped and all peripherals enabled.

AC Test Conditions

PARAMETER	RATING	UNIT
Supply Voltage (VDD)	3.0 to 3.6	V
Core Voltage (VDDC)	1.62 to 1.98	V
Input Pulse Levels	VSS to VDD	V
Input Rise and Fall Times	2	ns
Input and Output Timing Ref. Levels	VDD/2	V

AC Specifications

All signals described in Table 8 relate to transitions after a reference clock signal. The illustration in Figure 7 represents all cases of these sets of measurement parameters; except for the Asynchronous Memory Interface — which are referenced to Address Valid.

The reference clock signals in this design are:

- HCLK, the System Bus clock
- PCLK, the Peripheral Bus clock (locked to HCLK in the LH79520)
- SSPCLK, the Synchronous Serial Interface clock
- UARTCLK, the UART Interface clock
- LCDDCLK, the LCD Data clock from the LCD Controller
- and SDCLK, the SDRAM clock.

All signal transitions are measured from the 50 % point of the clock to the 50 % point of the signal. See Figure 7.

For outputs from the LH79520, t_{OVXXX} (e.g. t_{OVA}) represents the amount of time for the output to become valid from the rising edge of the reference clock signal. Maximum requirements for t_{OVXXX} are shown in Table 8.

The signal t_{OHXXX} (e.g. t_{OHA}) represents the amount of time the output will be held valid from the rising edge of the reference clock signal. Minimum requirements for t_{OHXXX} are listed in Table 8.

For Inputs, t_{ISXXX} (e.g. t_{ISD}) represents the amount of time the input signal must be valid before the rising edge of the clock signal. Minimum requirements for t_{ISXXX} are shown in Table 8.

The signal t_{IHXXX} (e.g. t_{IHD}) represents the amount of time the memory output must be held valid from the rising edge of the reference clock signal. Minimum requirements are shown in Table 8.

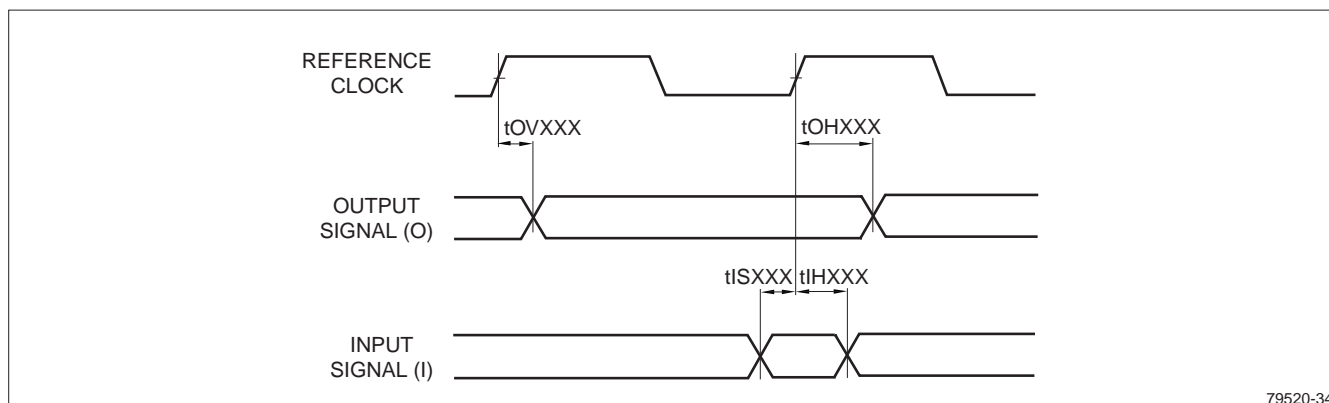

79520-34

Figure 7. LH79520 Signal Timing

Table 8. AC Signal Characteristics (Commercial)

SIGNAL	TYPE	LOAD	DRIVE	SYMBOL	MIN.	MAX.	DESCRIPTION
ASYNCHRONOUS MEMORY INTERFACE SIGNALS							
D[31:0]	Output	50 pF	8 mA	tOVD		tHCLK + 6 ns	Data Output Valid, following Address Valid
				tOHD	3 × tHCLK - 6 ns		Data Output Invalid, following Address Valid
	Input			tIDD		2 × tHCLK - 18 ns	Data Input Valid, following Address Valid
						2 × tHCLK - 18 ns + (nWAIT - 1) × tHCLK	
nCS6 - nCS0	Output	30 pF	8 mA	tOVCS		tHCLK + 6 ns	Chip Select Output Valid, following Address Valid
				tOHCS	3 × tHCLK - 6 ns		Chip Select Output Invalid, following Address Valid
nBLE[3:0]	Output	30 pF	8 mA	tOVBE		tHCLK + 10 ns	Byte Lane Enable Valid, following Address Valid
				tOHBEW	2 × tHCLK - 6 ns		Byte Lane Enable Invalid, following Address Valid; Write Cycle
				tOHBER	3 × tHCLK - 6 ns		Byte Lane Enable Invalid, following Address Valid; Read Cycle
nWE	Output	30 pF	8 mA	tOVWE		tHCLK + 10 ns	Write Enable Valid, following Address Valid
				tOHWE	2 × tHCLK - 6 ns	2 × tHCLK - 6 ns	Write Enable Invalid, following Address Valid
nOE	Output	30 pF	8 mA	tOVOE		tHCLK + 10 ns	Output Enable Valid, following Address Valid
				tOHOE	3 × tHCLK - 6 ns		Output Enable Invalid, following Address Valid
nWAIT	Input			tISWAIT		2 × tHCLK - 18 ns	WAIT Input Valid, following Address Valid
SYNCHRONOUS MEMORY INTERFACE SIGNALS							
A[25:0]	Output	50 pF	8 mA	tOVA		10.5 ns	Address Valid
D[31:0]	Output	50 pF	8 mA	tOVD		11 ns	Output Data Valid
				tOHD	1.2 ns		Output Data Hold
	Input			tISD	5 ns		Input Data Setup
				tIDD	1.5 ns		Input Data Hold
nCAS	Output	50 pF	8 mA	tOVCA		10.5 ns	CAS Valid
				tOHCA	2 ns		CAS Hold
nRAS	Output	50 pF	8 mA	tOVRA		10.5 ns	RAS Valid
				tOHRA	2 ns		RAS Hold
nSDWE	Output	30 pF	8 mA	tOVSDW		10.5 ns	SDWE Write Enable Valid
				tOHSDW	2 ns		SDWE Write Enable Hold
SDCKE	Output	30 pF	8 mA	tOVCO		10.5 ns	SDCKE Clock Enable Valid
				tOHCO	2 ns		SDCKE Clock Enable Hold
DQM[3:0]	Output	30 pF	8 mA	tOVDDQ		10.5 ns	DQM Data Mask Valid
				tOHDDQ	2 ns		DQM Data Mask Hold
nSDCS[1:0]	Output	30 pF	8 mA	tOVSC		10.5 ns	SDCS Data Mask Valid
				tOHSC	2 ns		SDCS Data Mask Hold
SDCLK	Output	30 pF	8 mA	tSDCLK	19.37 ns		SDRAM Clock Period

Table 8. AC Signal Characteristics (Commercial) (Cont'd)

SIGNAL	TYPE	LOAD	DRIVE	SYMBOL	MIN.	MAX.	DESCRIPTION
SYNCHRONOUS SERIAL PORT (SSP)							
SSPFRM	Output	50 pF	2 mA	tOVSSPFRM		14 ns	tOVSSPFRM Output Valid, Referenced to SSPCLK
SSPEN	Output	50 pF	2 mA	tOVSSPENB		14ns	tOVSSPEN Output Valid, Referenced to SSPCLK
SSPTX	Output	50 pF	2 mA	tOVSSPOUT		14ns	SSP Transmit Valid
SSPRX	Input			tISSPIN	17 ns		SSP Receive Setup
INTERRUPTS							
INTR[5:0]	Input						Note 1

NOTES:

1. INTR[5:0] are asynchronous signals. Interrupts must be held Active until serviced in Level Sensitive Mode, and held Active for a minimum of 20 ns in Edge Sensitive Mode.
2. nDACK0, DACK1 and DREQ[1:0] are asynchronous signals. They must be held Active until serviced, for a minimum of 20 ns.

DC/AC SPECIFICATIONS (INDUSTRIAL)

Unless otherwise noted, all data provided under industrial DC specifications are based on -40°C to +85°C, VDDC = 1.62 V to 1.98 V, VDD = 3.0 V to 3.6 V, VDDA = 1.62 V to 1.98 V.

DC Specifications (Industrial)

SYMBOL	PARAMETER	MIN.	TYP.	MAX.	UNIT	CONDITIONS	NOTES
VIH	CMOS input HIGH voltage	2.0		5.5	V		
VIL	CMOS input LOW voltage			0.8	V		
VIT+	Positive Input threshold voltage (Schmitt trigger pins)		1.60		V		1
VIT-	Negative Input threshold voltage (Schmitt trigger pins)		1.20		V		
VHST	Schmitt trigger hysteresis		0.40		V	VIT+ – VIT-	
VOH	CMOS output HIGH voltage	2.6			V	IOH = -50 μ A	1
	Output drive (2 mA type)	2.6			V	IOH = -2 mA	
	Output drive (4 mA type)	2.6			V	IOH = -4 mA	
	Output drive (8 mA type)	2.6			V	IOH = -8 mA	
VOL	CMOS output LOW voltage			0.4	V	IOL = 50 μ A	1
	Output drive (2 mA type)			0.4	V	IOL = 2 mA	
	Output drive (4 mA type)			0.4	V	IOL = 4 mA	
	Output drive (8 mA type)			0.4	V	IOL = 8 mA	
XTAL32IN	External Clock Input	1.62	1.8	1.98	V		2
XTALIN	External Clock Input	1.62	1.8	1.98	V		2
IIN	Input leakage current	-10		10	μ A	VIN = VDD or GND	
IOZ	Output tri-state leakage current	-10		10	μ A	VOUT = VDD or GND	
IACTIVE	Active current		43.5		mA		3
ISTANDBY	Standby current		27.5		mA		3, 4
ISLEEP	Sleep current		3.9		mA		
ISTOP1	Stop1 current		500		μ A		
ISTOP2	Stop2 current (RTC ON)		34		μ A		
ISTOP2	Stop2 current (RTC OFF)		18		μ A		
CIN	Input Capacitance			4	pF		
COUT	Output Capacitance			4	pF		
RPULL	Pull-up or Pull-down Resistance			33	K Ω		

NOTES:

- Table 2 details each pin's buffer type.
- P-P Sinusoidal; 0.0 V DC offset.
- Running Typical Application over operating range.
- Current measured with CPU stopped and all peripherals enabled.

AC Test Conditions

PARAMETER	RATING	UNIT
Supply Voltage (VDD)	3.0 to 3.6	V
Core Voltage (VDDC)	1.62 to 1.98	V
Input Pulse Levels	VSS to VDD	V
Input Rise and Fall Times	2	ns
Input and Output Timing Ref. Levels	VDD/2	V

CURRENT CONSUMPTION BY OPERATING MODE

Current consumption can depend on a number of parameters. To make this data more usable, the values presented in Table 9 were derived under the conditions presented here.

Maximum Specified Value

The values specified in the MAXIMUM column were determined using these operating characteristics:

- All IP blocks either operating or enabled at maximum frequency and size configuration
- Core operating at maximum power configuration
- All I/O loads at maximum (50 pF)
- All voltages at maximum specified values
- Maximum specified ambient temperature.

Typical

The values in the TYPICAL column were determined using a 'typical' application under 'typical' environmental conditions and the following operating characteristics:

- SPI, UART, PWMs, and Timer peripherals operating; all other peripherals disabled
- LCD enabled with 320 × 240 × 16-bit color, 60 Hz refresh rate
- I/O loads at nominal
- Cache enabled
- FCLK = 77.4 MHz; HCLK = 51.6 MHz
- All voltages at typical values
- Nominal case temperature.

PERIPHERAL CURRENT CONSUMPTION

In addition to the modal current consumption, Table 10 shows the typical current consumption for each of the on-board peripheral blocks. The values were determined with the peripheral clock running at maximum frequency, typical conditions, and no I/O loads.

Table 9. Current Consumption by Mode

SYMBOL	PARAMETER	TYP.	UNITS
ACTIVE MODE*			
ICORE	Core Current	33.6	mA
IIO	I/O Current	9.6	mA
STANDBY MODE			
ICORE	Core Current	29.6	mA
IIO	Current drawn by I/O	0.8	mA
SLEEP MODE			
ICORE	Core Current	3.8	mA
IIO	Current drawn by I/O	2	μA
STOP1 MODE			
ILEAK	Leakage Current, Core and I/O	2.96	mA
STOP2 MODE (RTC ON)			
ILEAK	Leakage Current, Core and I/O	35	μA
STOP2 MODE (RTC OFF)			
ILEAK	Leakage Current, Core and I/O	18	μA

NOTE: *ICORE = 58 mA MAX., IIO = 19 mA MAX., all active

Table 10. Peripheral Current Consumption

PERIPHERAL	TYPICAL	UNITS
UARTs	200	μA
RTC	5	μA
DMA	4.1	mA
SSP	500	μA
Counter/Timers	207	μA
LCD	2.2	mA

AC Specifications (Industrial)

Table 11. AC Signal Characteristics (Industrial)

SIGNAL	TYPE	LOAD	DRIVE	SYMBOL	MIN.	MAX.	DESCRIPTION
ASYNCHRONOUS MEMORY INTERFACE SIGNALS							
D[31:0]	Output	50 pF	8 mA	tOVD		tHCLK + 6.5 ns	Data Output Valid, following Address Valid
				tOHD	3 × tHCLK – 6 ns		Data Output Invalid, following Address Valid
	Input			tIDD		2 × tHCLK – 18 ns	Data Input Valid, following Address Valid (1 WAIT state)
						2 × tHCLK – 18 ns + (nWAIT – 1) × tHCLK	
nCS6 - nCS0	Output	30 pF	8 mA	tOVCS		tHCLK + 6 ns	Chip Select Output Valid, following Address Valid
				tOHCS	3 × tHCLK – 6 ns		Chip Select Output Invalid, following Address Valid
nBLE[3:0]	Output	30 pF	8 mA	tOVBE		tHCLK + 10 ns	Byte Lane Enable Valid, following Address Valid
				tOHBEW	2 × tHCLK – 6 ns		Byte Lane Enable Invalid, following Address Valid; Write Cycle
				tOHBER	3 × tHCLK – 6 ns		Byte Lane Enable Invalid, following Address Valid; Read Cycle
nWE	Output	30 pF	8 mA	tOVWE		tHCLK + 10 ns	Write Enable Valid, following Address Valid
				tOHWE	2 × tHCLK – 6 ns	2 × tHCLK - 6 ns	Write Enable Invalid, following Address Valid
nOE	Output	30 pF	8 mA	tOVOE		tHCLK + 10 ns	Output Enable Valid, following Address Valid
				tOHOE	3 × tHCLK – 6 ns		Output Enable Invalid, following Address Valid
nWAIT	Input			tISWAIT		2 × tHCLK – 18 ns	WAIT Input Valid, following Address Valid
SYNCHRONOUS MEMORY INTERFACE SIGNALS							
A[25:0]	Output	50 pF	8 mA	tOVA		10.5 ns	Address Valid
D[31:0]	Output	50 pF	8 mA	tOVD		11.5 ns	Output Data Valid
				tOHD	1.2 ns		Output Data Hold
	Input			tISD	5 ns		Input Data Setup
				tIDD	1.5 ns		Input Data Hold
nCAS	Output	50 pF	8 mA	tOVCA		11 ns	CAS Valid
				tOHCA	2 ns		CAS Hold
nRAS	Output	50 pF	8 mA	tOVRA		11 ns	RAS Valid
				tOHRA	2 ns		RAS Hold
nSDWE	Output	30 pF	8 mA	tOVSDW		11 ns	SDWE Write Enable Valid
				tOHSDW	2 ns		SDWE Write Enable Hold
SDCKE	Output	30 pF	8 mA	tOVCO		11 ns	SDCKE Clock Enable Valid
				tOHCO	2 ns		SDCKE Clock Enable Hold
DQM[3:0]	Output	30 pF	8 mA	tOVDQ		11 ns	DQM Data Mask Valid
				tOHDQ	2 ns		DQM Data Mask Hold

Table 11. AC Signal Characteristics (Cont'd)(Industrial)

SIGNAL	TYPE	LOAD	DRIVE	SYMBOL	MIN.	MAX.	DESCRIPTION
nSDCS[1:0]	Output	30 pF	8 mA	tOVSC		11 ns	SDCS Data Mask Valid
				tOHSC	2 ns		SDCS Data Mask Hold
SDCLK	Output	30 pF	8 mA	tSDCLK	19.37 ns		SDRAM Clock Period
SYNCHRONOUS SERIAL PORT (SSP)							
SSPFRM	Output	50 pF	2 mA	tOVSSPFRM		14 ns	SSPFRM Output Valid, Referenced to SSPCLK
SSPEN	Output	50 pF	2 mA	tOVSSPENB		14ns	SSPEN Output Valid, Referenced to SSPCLK
SSPTX	Output	50 pF	2 mA	tOVSSPOUT		14ns	SSP Transmit Valid
SSPRX	Input			tISSPIN	17 ns		SSP Receive Setup
INTERRUPTS							
INTR[5:0]	Input						Note 1

NOTES:

- INTR[5:0] are asynchronous signals. Interrupts must be held Active until serviced in Level Sensitive Mode, and held Active for a minimum of 20 ns in Edge Sensitive Mode.
- nDACK0, DACK1 and DREQ[1:0] are asynchronous signals. They must be held Active until serviced, for a minimum of 20 ns.

EXTERNAL CLOCKS

Table 12. External Clocks AC Specifications

SYMBOL	DESCRIPTION	MIN.	UNIT
tCLKIN	CLKIN Period	6.66	ns
tCLKINH	CLKIN HIGH Time	2.8	ns
tCLKINL	CLKIN LOW Time	2.8	ns
tSSPCLK	SSPCLK Period	1	PCLK
tSSPCLKH	SSPCLK HIGH Time	0.4	PCLK
tSSPCLKL	SSPCLK LOW Time	0.4	PCLK
tUCLK	UCLK	1	PCLK
tUCLKH	UCLK HIGH Time	0.4	PCLK
tUCLKL	UCLK LOW Time	0.4	PCLK

NOTES:

- PCLK is the period chosen for the internal peripheral clock domain.
- MAX. period is DC. See 'Recommended Operating Conditions'.

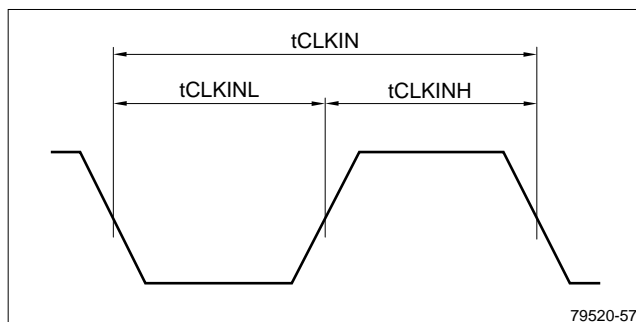

Figure 8. External Clock AC Timing

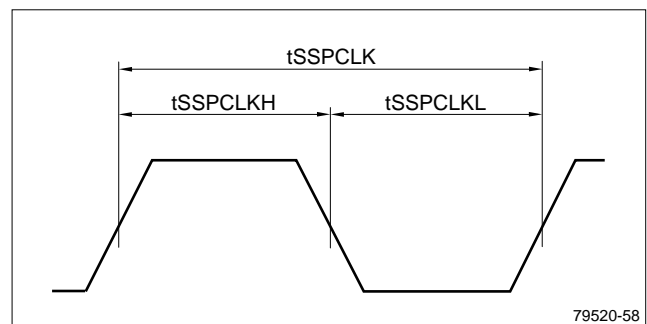

Figure 9. Synchronous Serial I/F Clocks AC Timing

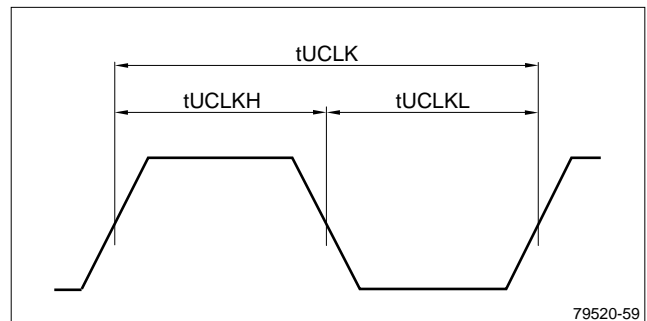

Figure 10. External UARTs/SIR Clock AC Timing

Static Memory Controller Waveforms

nWAIT INPUT

The Static Memory Controller (SMC) supports an nWAIT input that can be used by an external device to extend the wait time during a memory access. The SMC samples nWAIT at the beginning of at the beginning of each system clock cycle. The system clock cycle in which the nCSx signal is asserted counts as the first wait state. See Figure 11.

The SMC recognizes that nWAIT is active within 2 clock cycles after it has been asserted. To assure that the current access (read or write) will be extended by nWAIT, at least two wait states must be programmed for this bank of memory. If N wait states are programmed, then the Static Memory Controller (SMC) holds this state for N system clocks, or until the SMC detects that nWAIT is inactive, whichever occurs last. As the number of wait states programmed increases, the amount of delay before nWAIT must be asserted also increases. If only 2 wait states are programmed,

then nWAIT must be asserted in the clock cycle immediately following the clock cycle during which the nCSx signal is asserted. Once the SMC detects that the external device has deactivated nWAIT, the SMC will complete its access in 3 system clock cycles.

The formula for the allowable delay between asserting nCSx and asserting nWAIT is:

$$t_{\text{ASSERT}} = (\text{system clock period}) \times (\text{Wait States} - 1)$$

(where Wait States is from 2 to 31.)

READ AND WRITE WAVEFORMS

Figure 12 shows the waveform and timing for an External Static Memory Write. Figure 13 shows the waveform and timing for an External Static Memory Read, with one Wait State. Figure 14 shows the waveform and timing for an External Static Memory Read, with two Wait States.

The signal tIDD is shown without a setup time, as measurements are made from the Address Valid point and HCLK is an internal signal, shown for reference only.

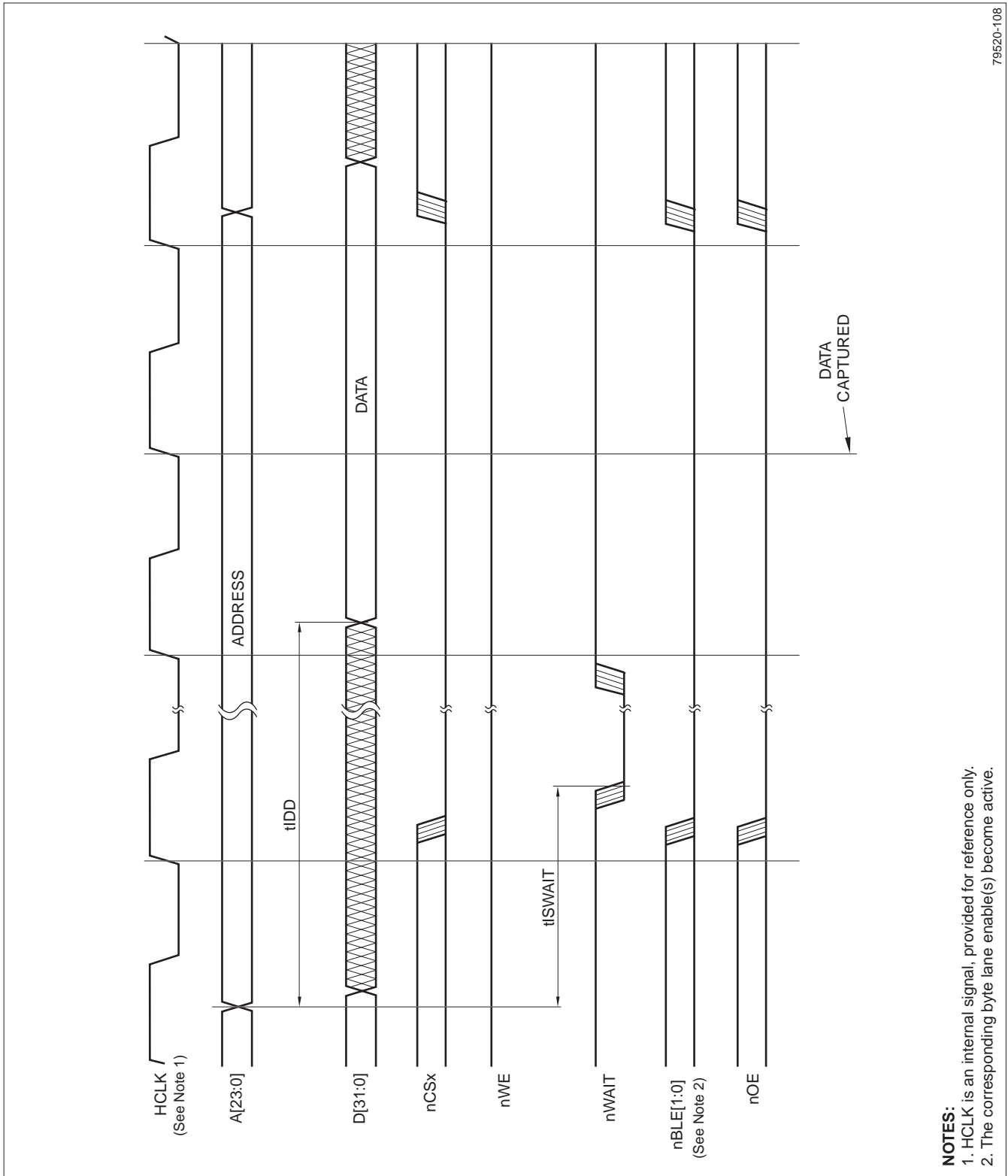

79520-108

- NOTES:**
1. HCLK is an internal signal, provided for reference only.
 2. The corresponding byte lane enable(s) become active.

Figure 11. nWait Assertion

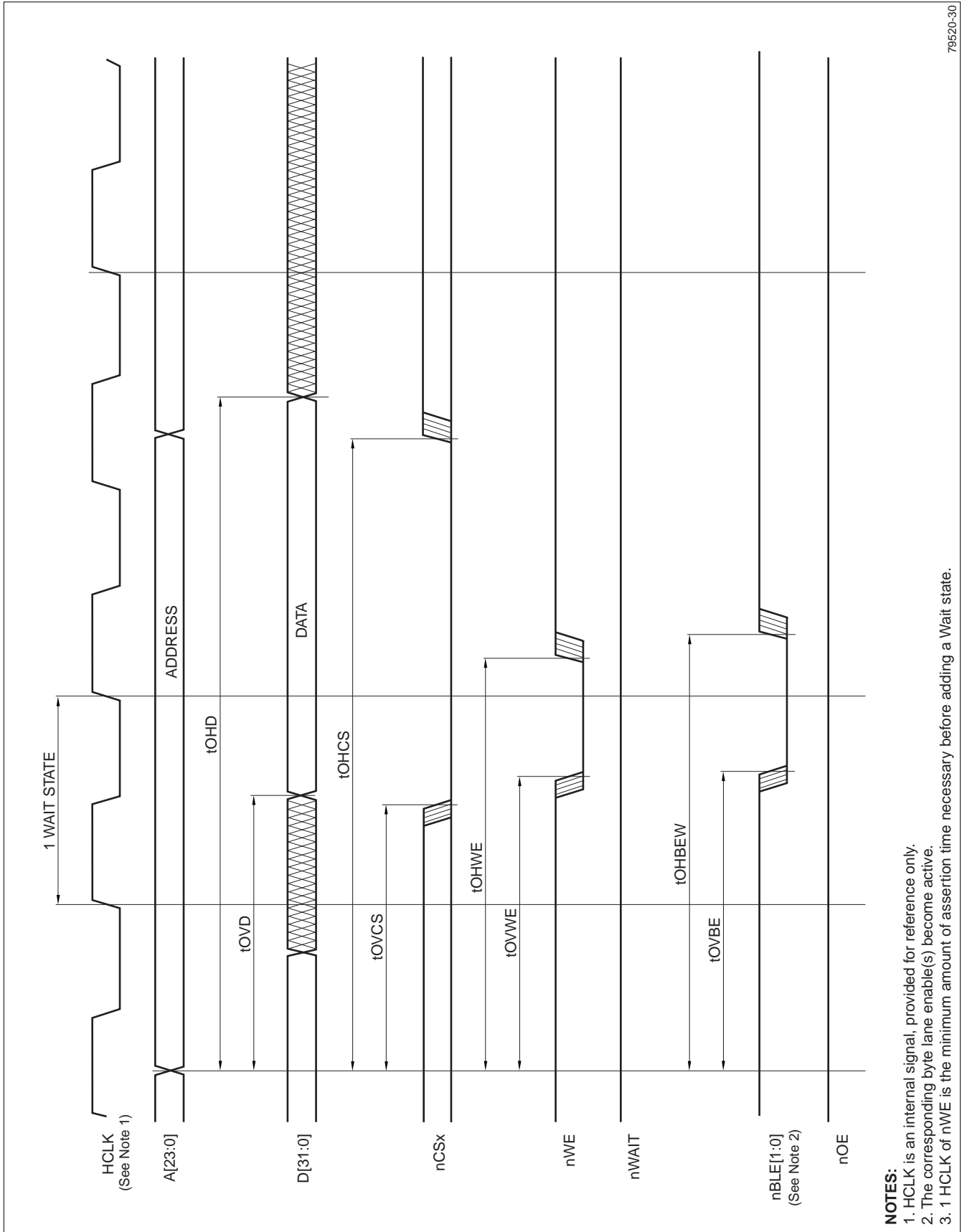
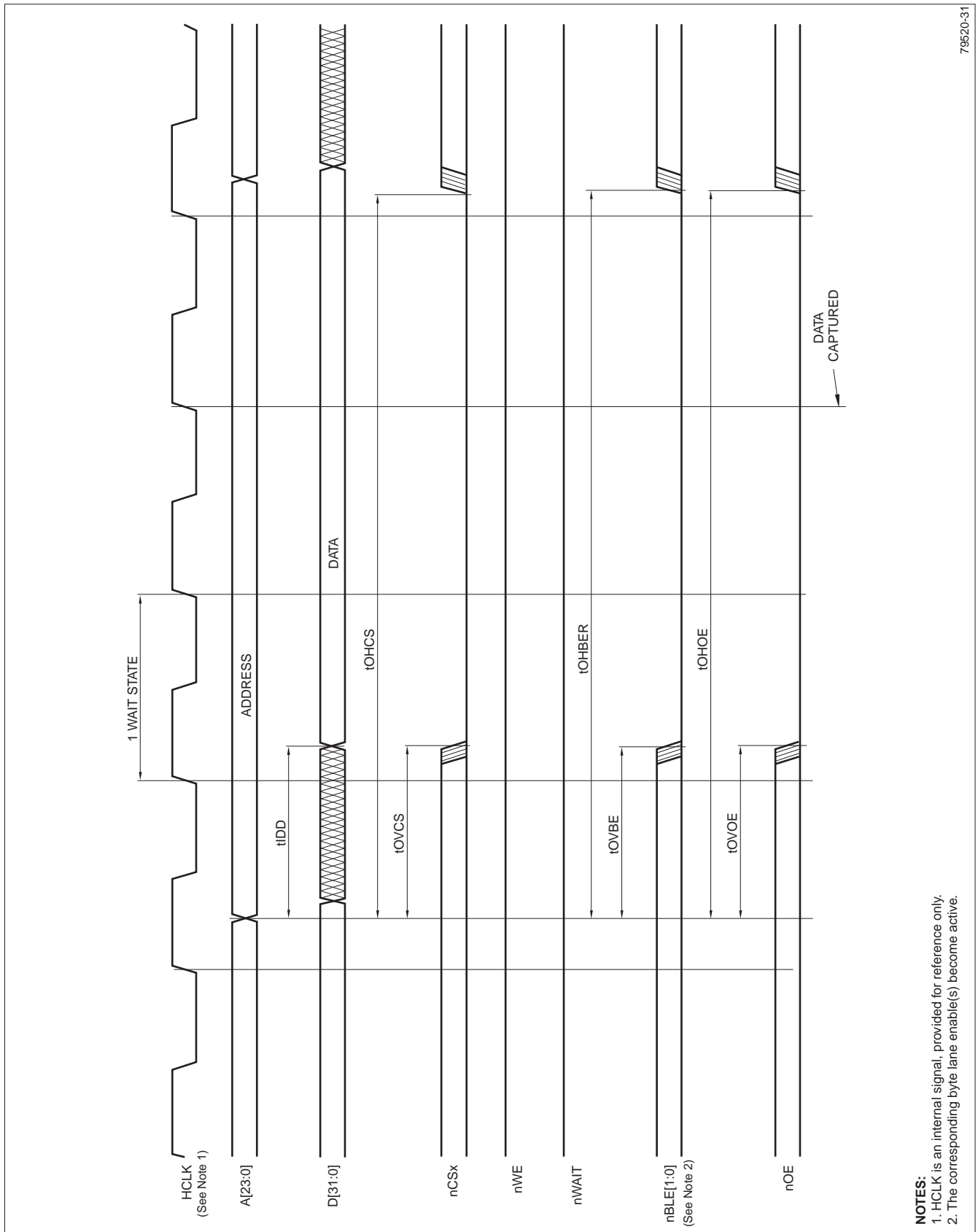

Figure 12. External Static Memory Write, One Wait State



79520-31

Figure 13. External Static Memory Read, One Wait State

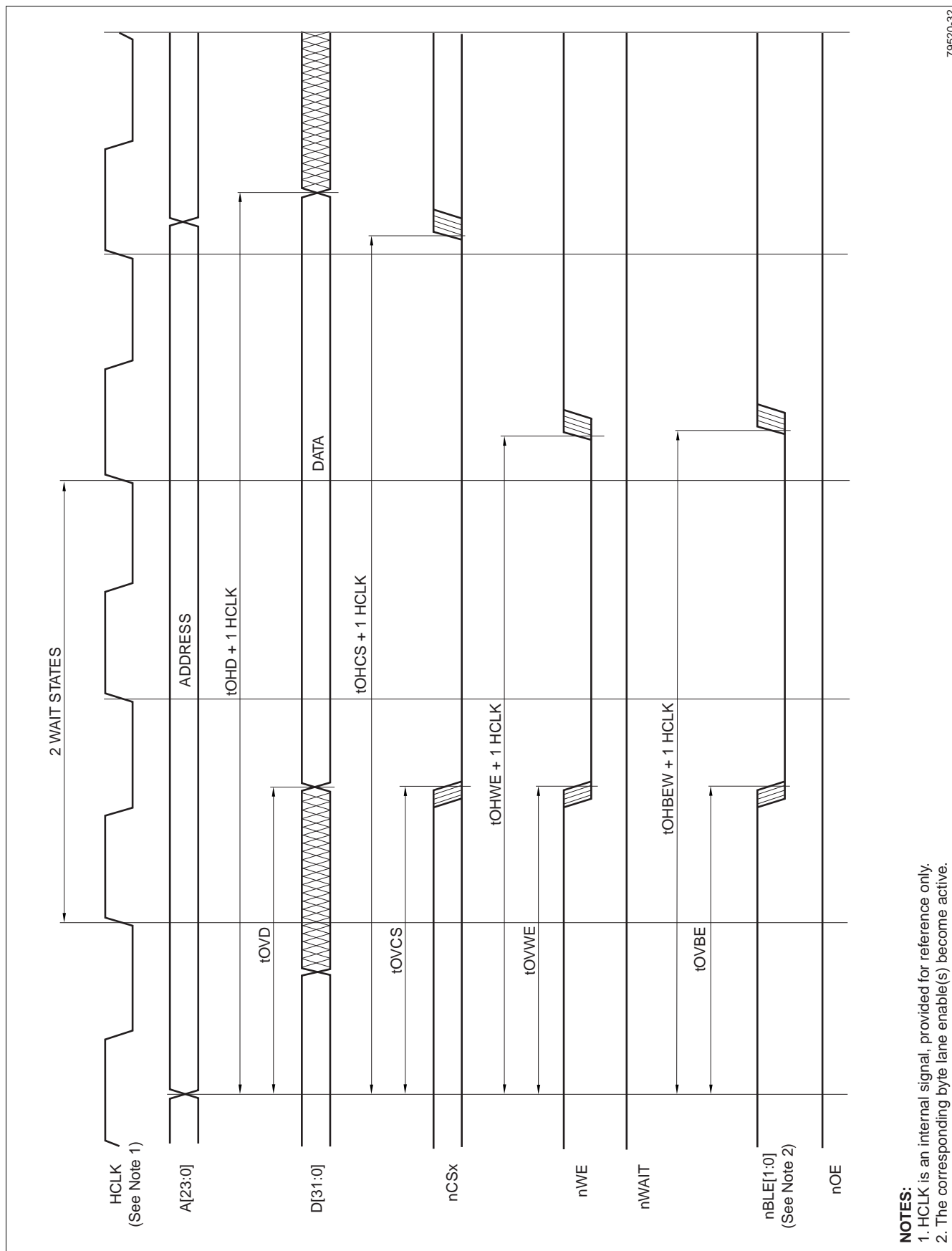
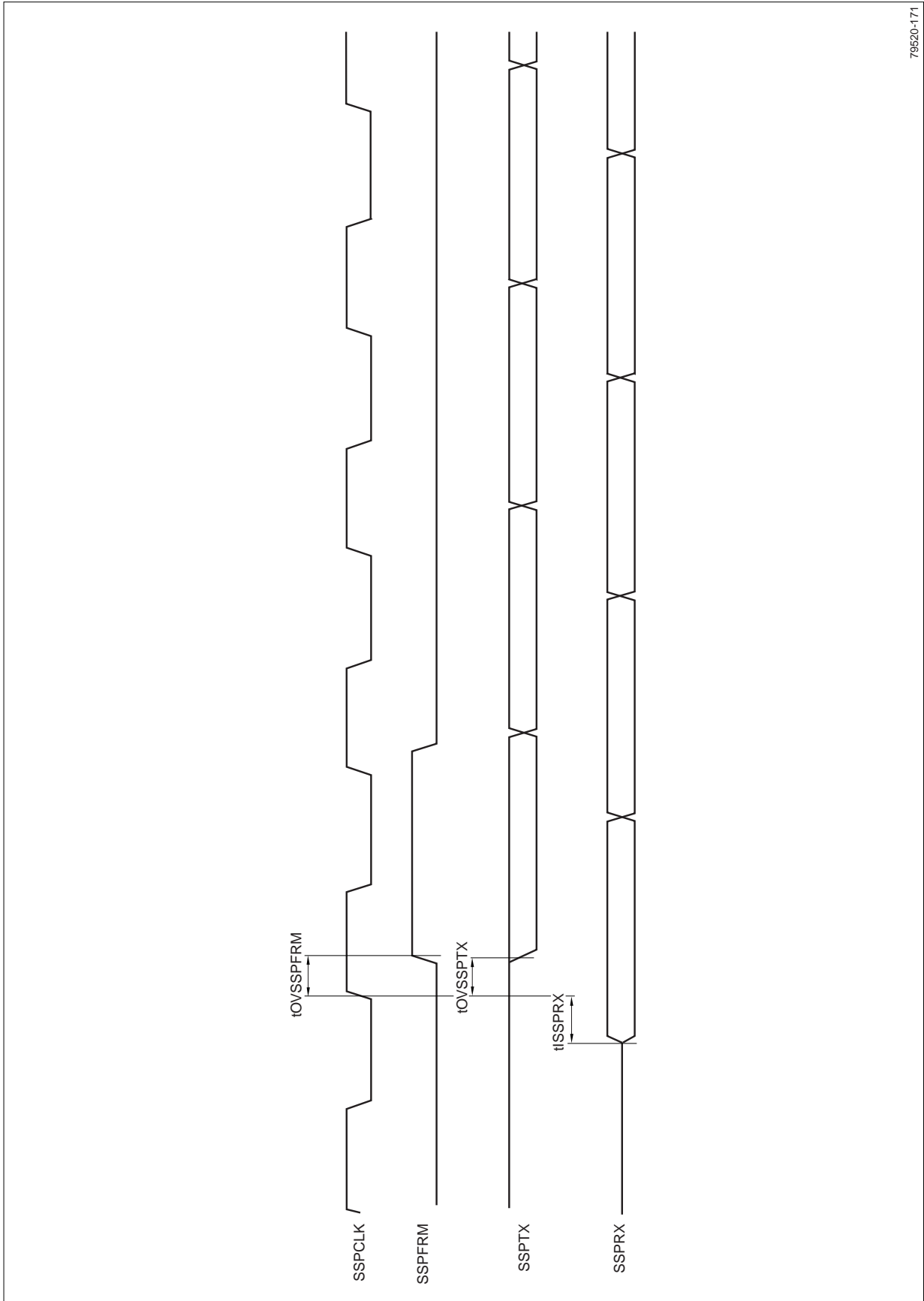

Figure 14. External Static Memory Write, Two Wait States



79520-171

Figure 15. Synchronous Serial Port Waveform

SDRAM Memory Controller Waveforms

Figure 16 shows the waveform and timing for an SDRAM Burst Read (page already open). Figure 17 shows the waveform and timing for SDRAM to Activate a Bank and Write.

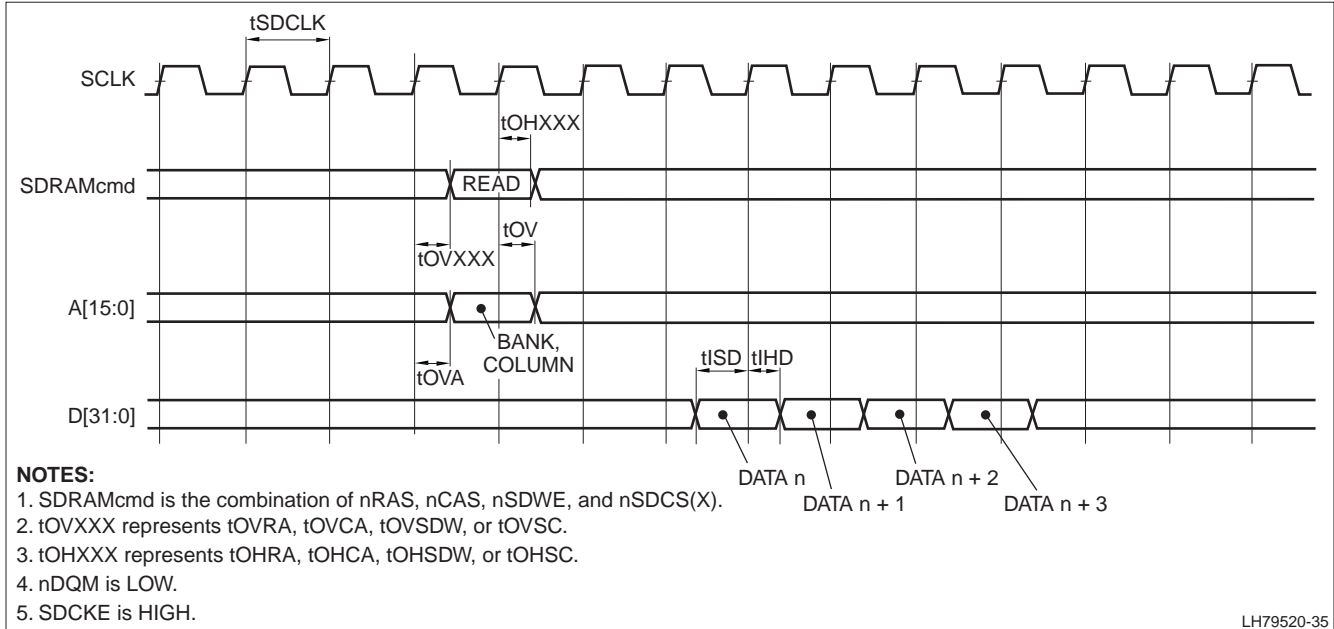

Figure 16. SDRAM Burst Read

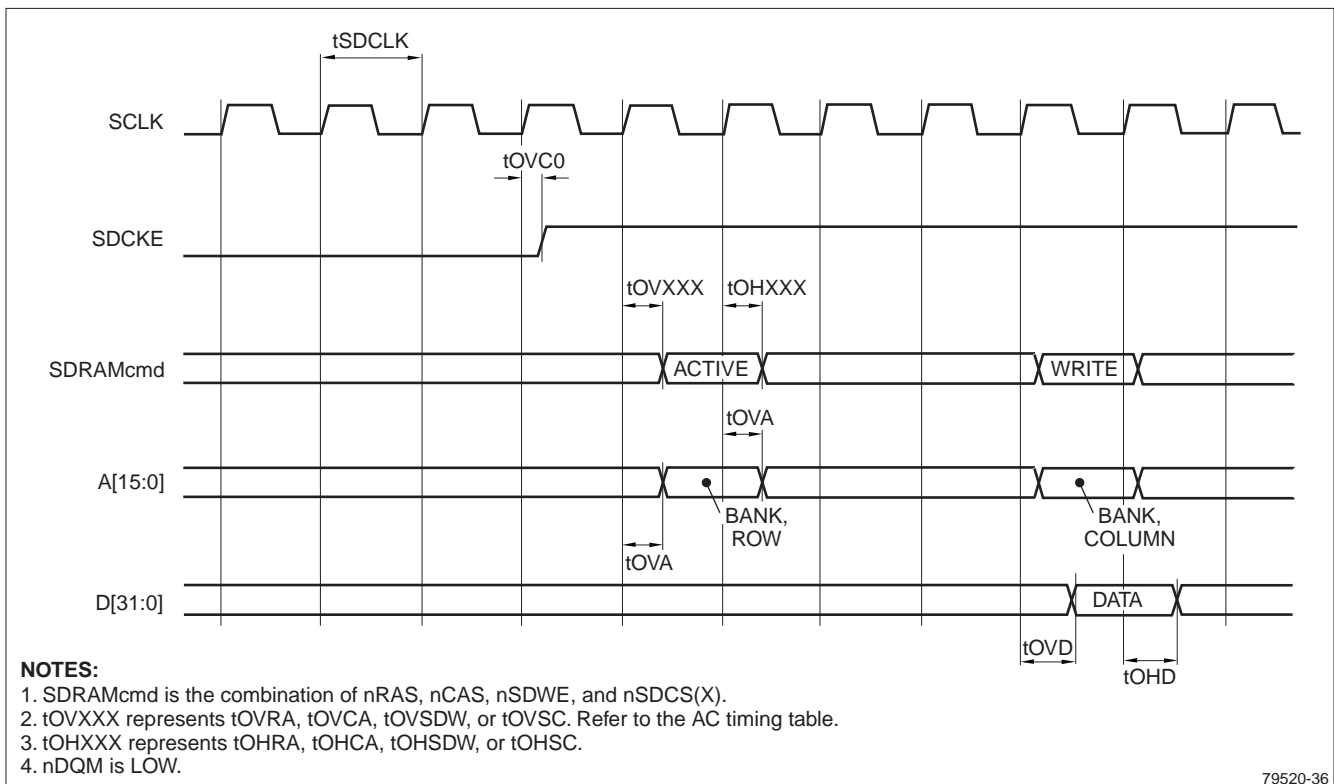

Figure 17. SDRAM Bank Activate and Write

External DMA Handshake Signal Timing

DREQ TIMING

As Figure 18 shows, once asserted, DREQ0 or DREQ1 must not transition from LOW to HIGH again until after nDACK0 or DACK1 has been asserted.

DACK/DEOT TIMING

These timing diagrams indicate when nDACK0, DACK1, DEOT0 and DEOT1 occur in relation to an external bus access to/from the external peripheral that requested the DMA transfer.

Figure 19 shows the timing with relation to a single read or the last word of a burst read from the requesting peripheral. Figure 20 shows the timing with relation to a single write or the last word of a burst write to the requesting peripheral.

The timing of DACK/DEOT may become unpredictable when a Write to SDRAM occurs just prior to a single word Write to the requesting peripheral. If the write buffer is enabled for the SDRAM Controller, this can cause the DACK/DEOT to occur an indeterminate number of cycles prior to the actual Write to the requesting peripheral.

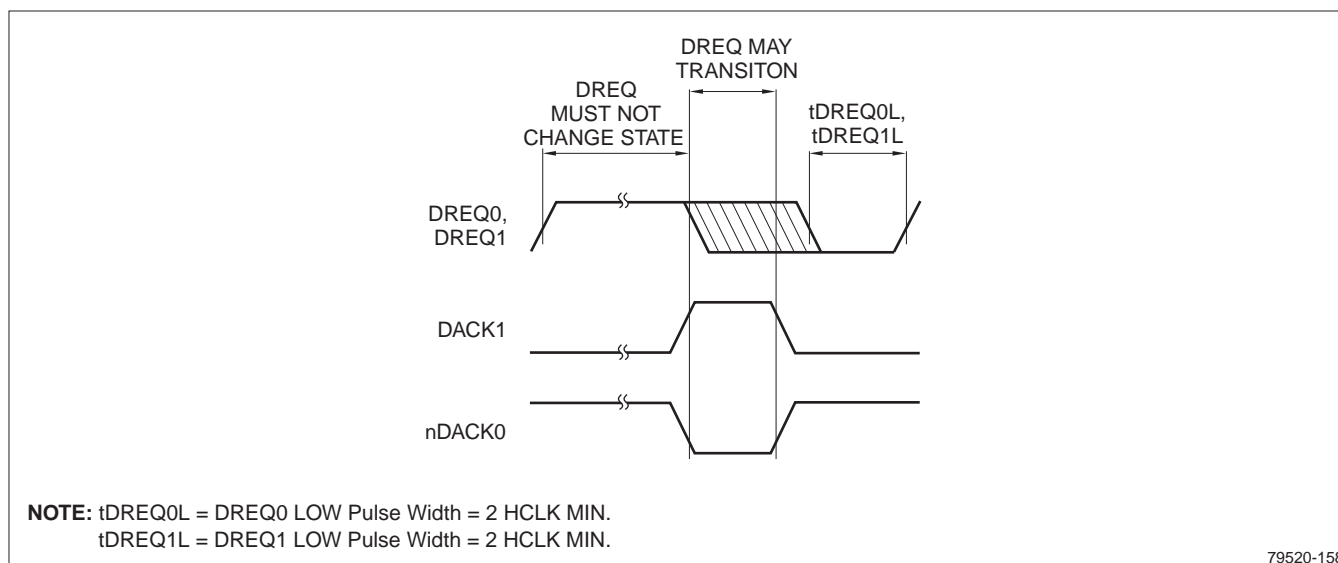

Figure 18. DREQ Timing Restrictions

79520-158

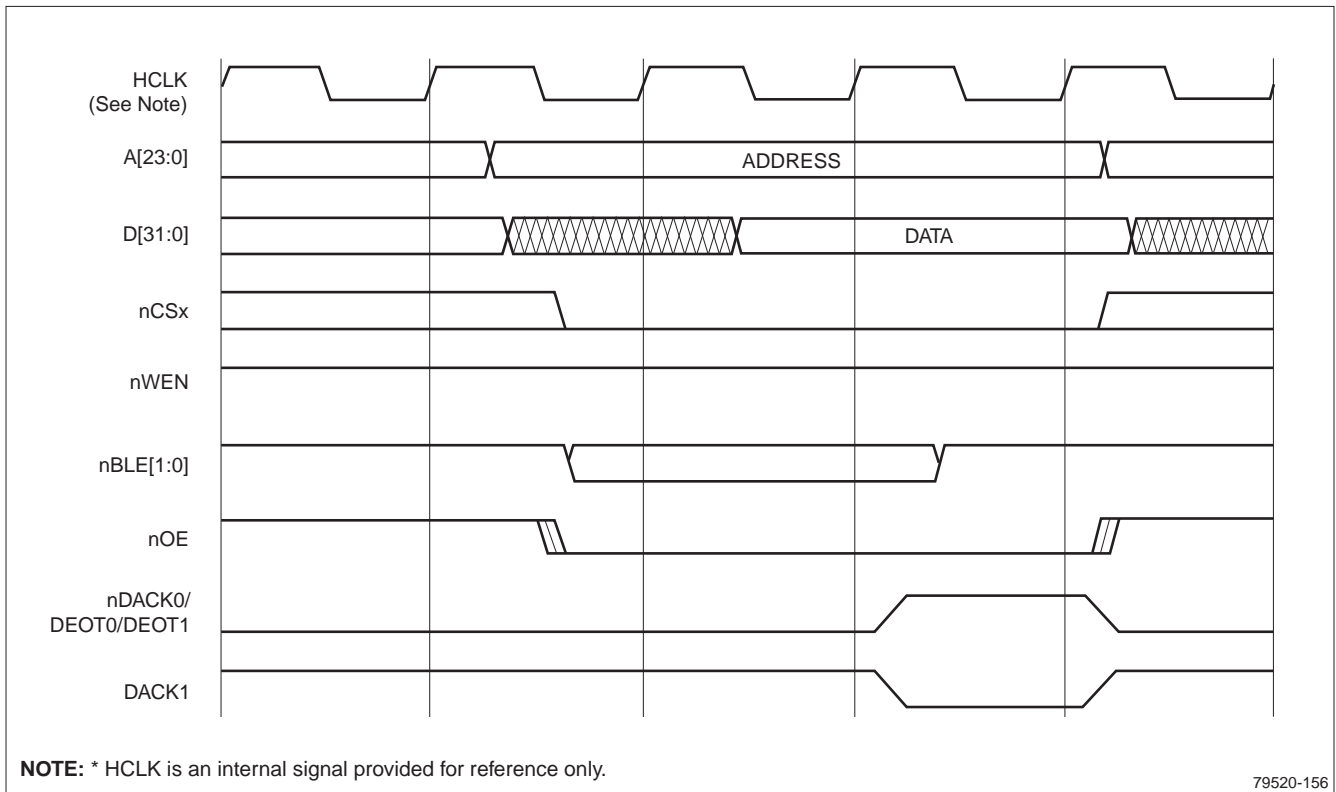

Figure 19. Read, from Peripheral to Memory, Burst Size = 1

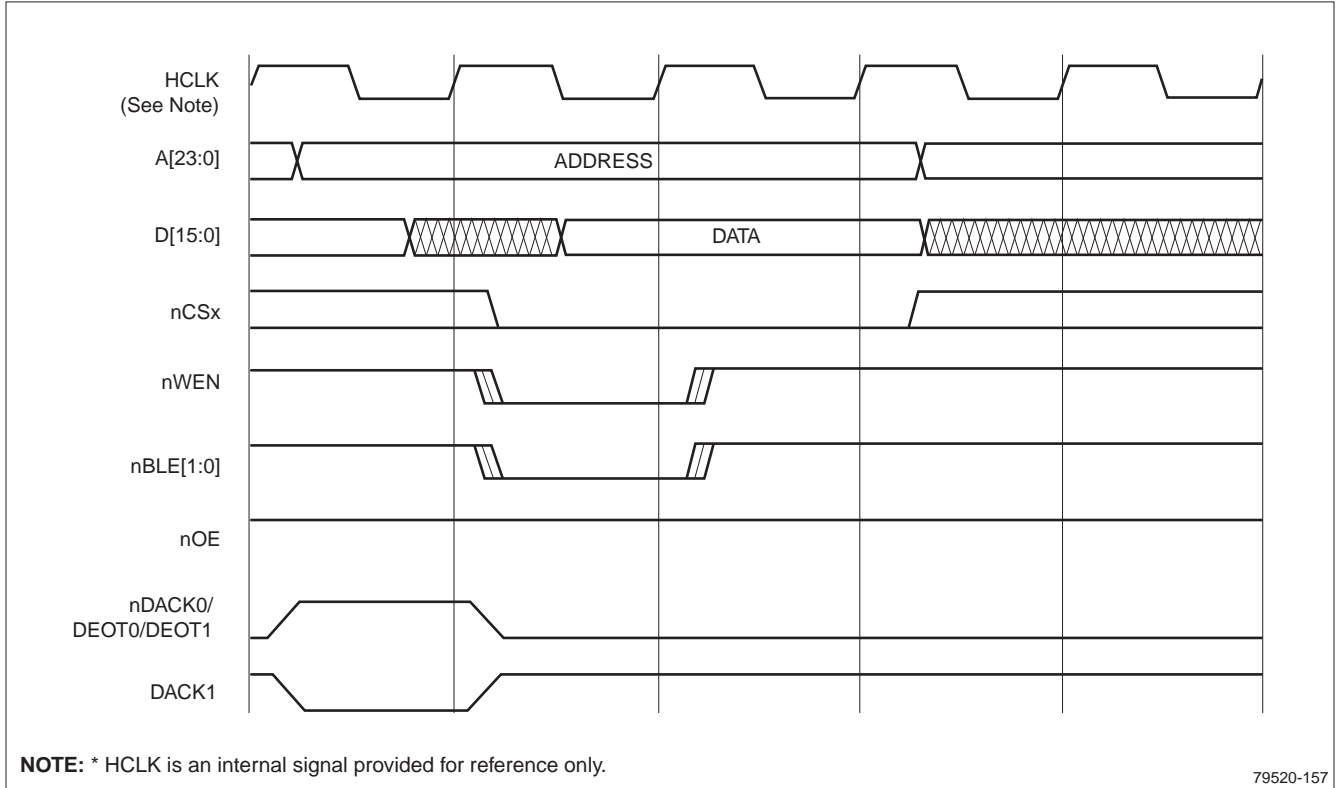

Figure 20. Write, from Memory to Peripheral, Burst Size = 1

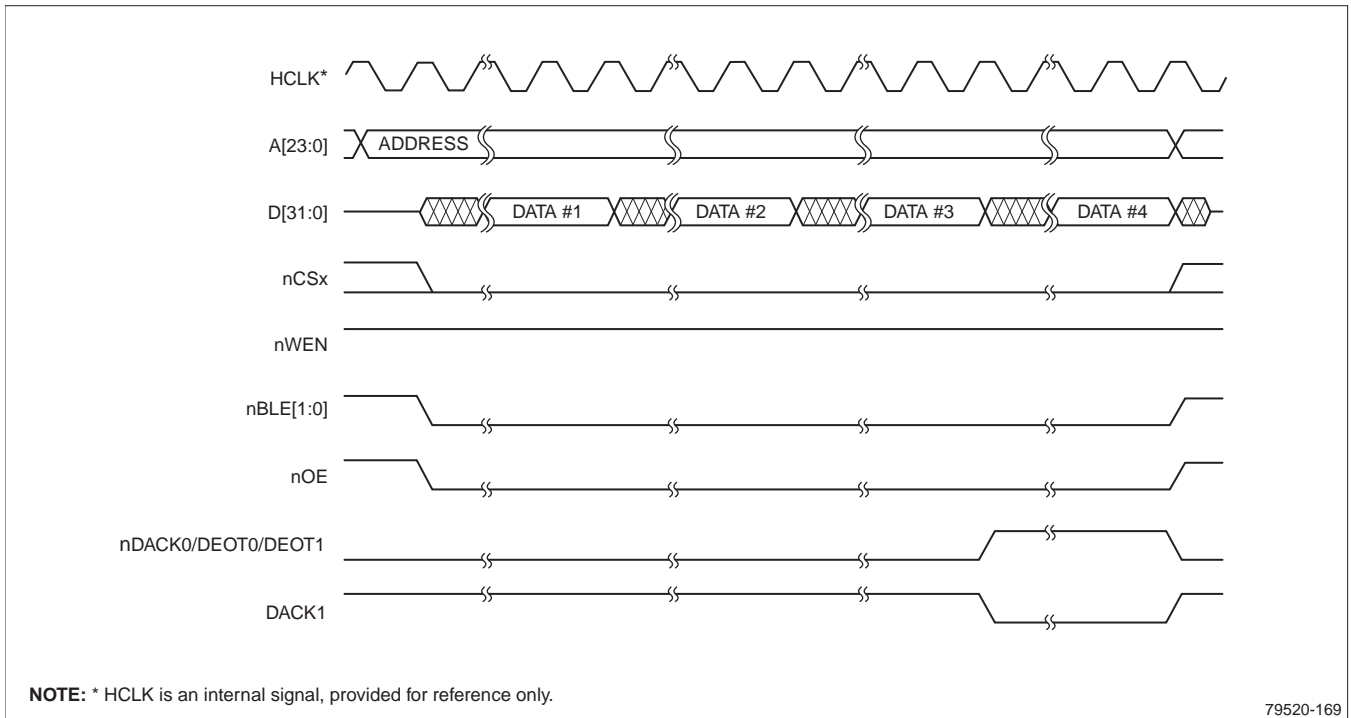

Figure 21. Read, Peripheral to Memory: Peripheral Burst Size = 4

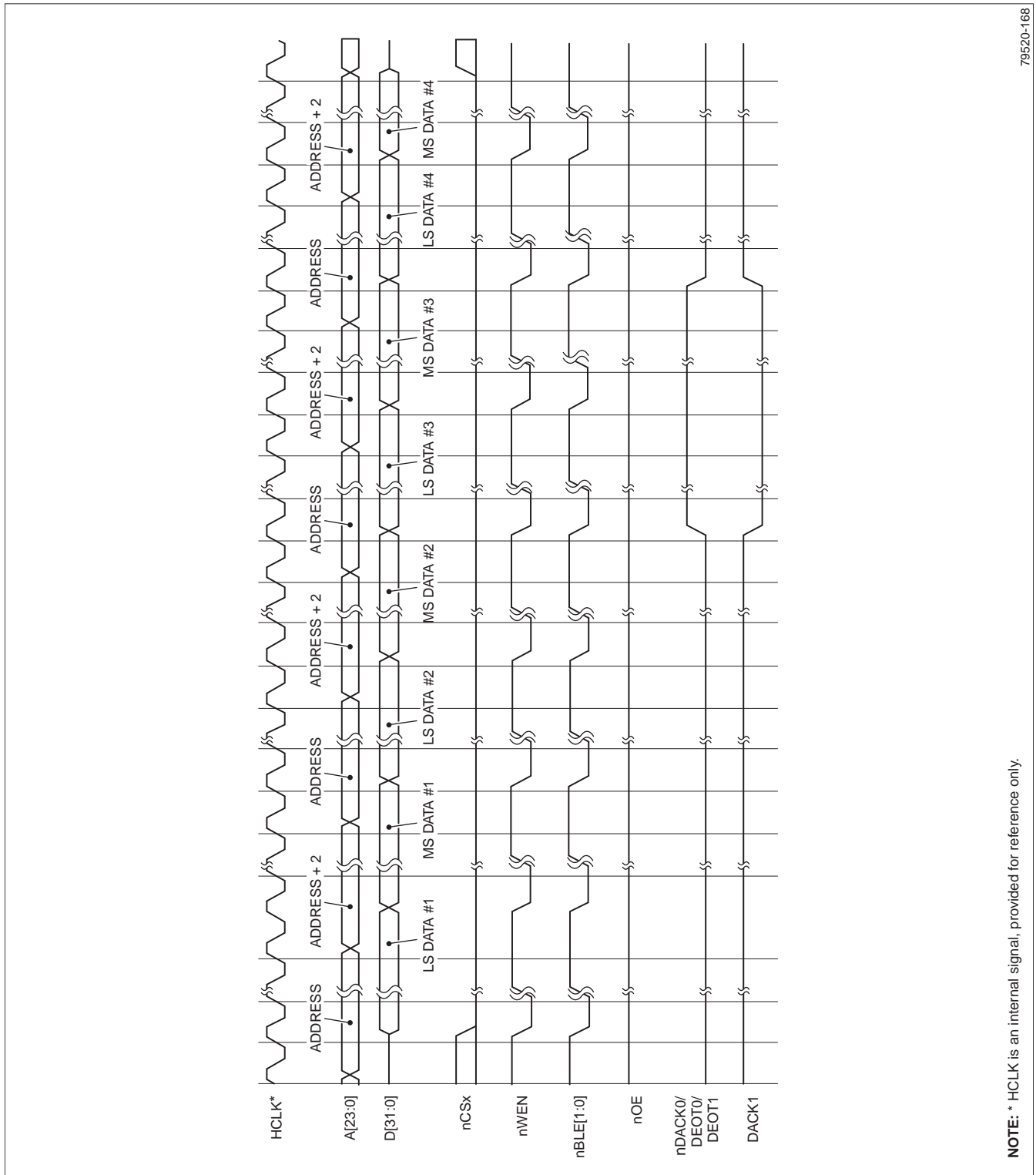

Figure 22. Write, Memory to Peripheral: Burst Size = 4; Destination Width > External Access Width

Color LCD Controller System Timing Waveforms

This section contains typical output waveform diagrams.

STN HORIZONTAL TIMING

Figure 23 presents typical horizontal timing waveforms for STN panels. Figure 23 shows that the CLCDC Clock (an input to the CLCDC) is scaled within the CLCDC and utilized to produce the LCDDCLK output.

Figure 24 presents typical vertical timing waveforms for STN panels.

TFT HORIZONTAL TIMING

Figure 25 presents typical horizontal timing waveforms for TFT panels.

TFT VERTICAL TIMING

Figure 26 presents typical vertical timing waveforms for TFT panels.

AD-TFT AND HR-TFT HORIZONTAL TIMING WAVEFORMS

Figure 27 presents typical horizontal timing waveforms for AD-TFT and HR-TFT panels. The ALI adjusts and delays the normal TFT timing for the Row and Column driver chips integrated into AD-TFT and HR-TFT panels. Other panels requiring the use of the ALI will have similar timing waveforms.

AD-TFT AND HR-TFT VERTICAL TIMING

Figure 28 presents typical vertical timing waveforms for AD-TFT and HR-TFT panels. The power sequencing and register information is the same as for TFT vertical timing.

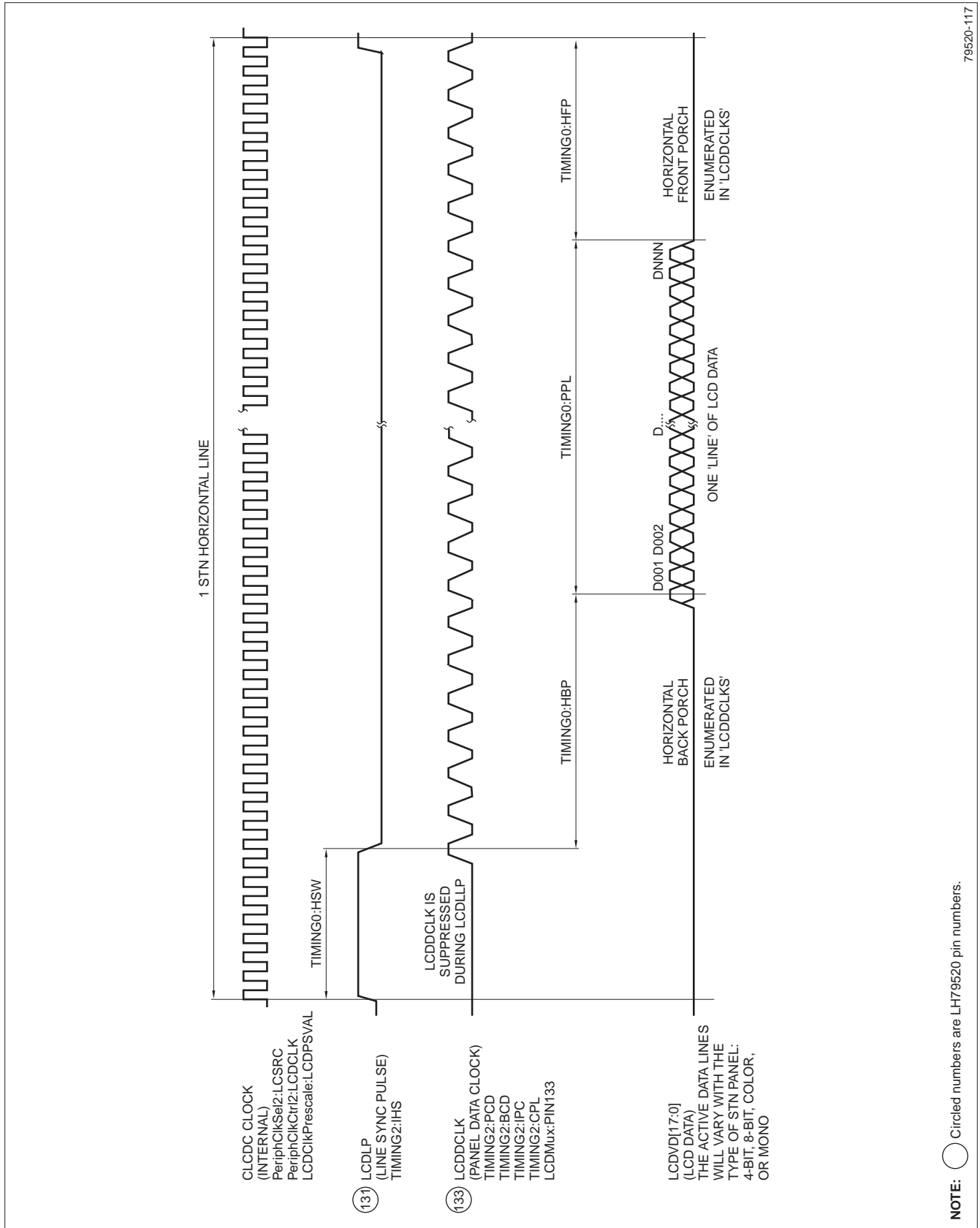

Figure 23. STN Horizontal Timing Diagram

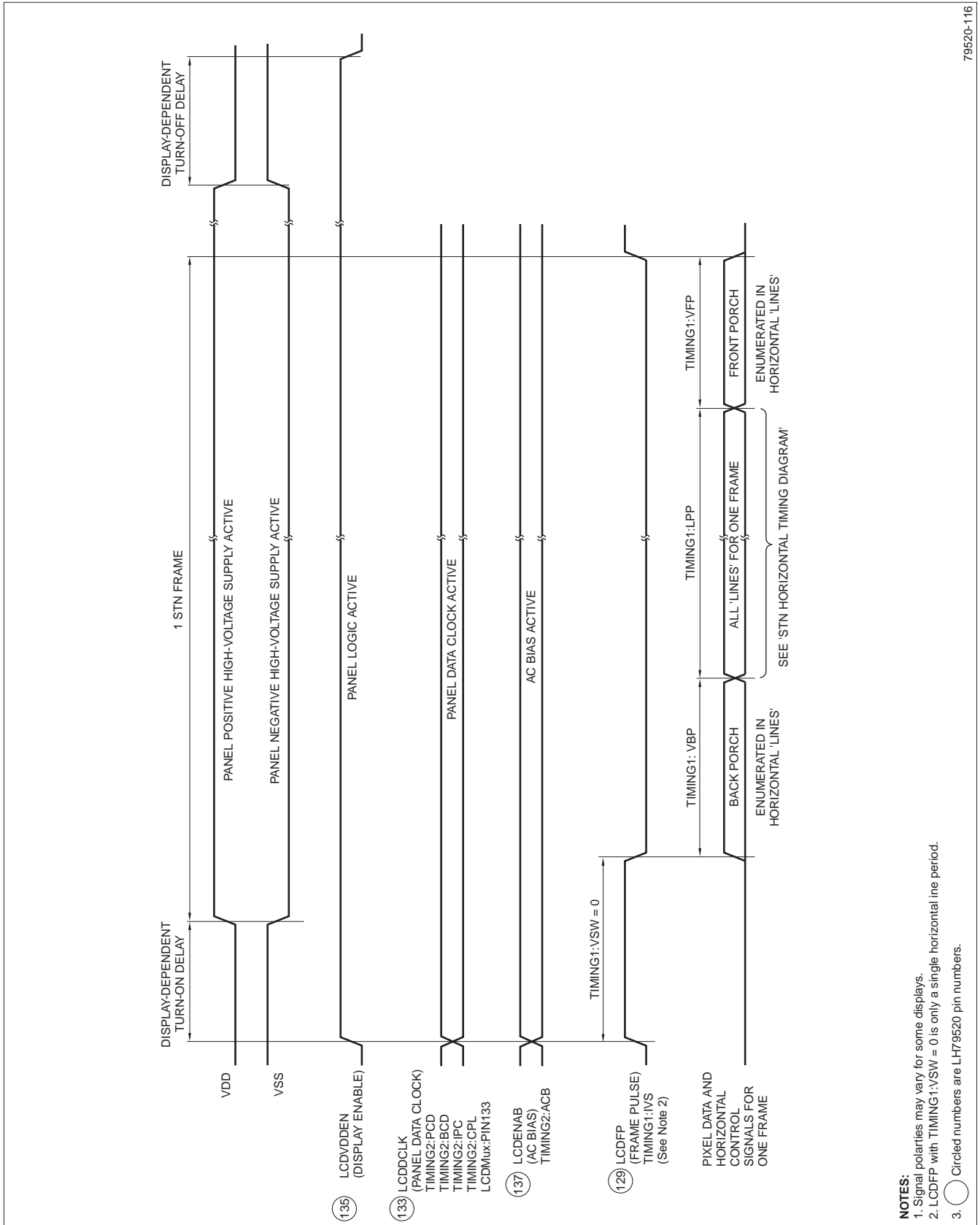

Figure 24. STN Vertical Timing Diagram

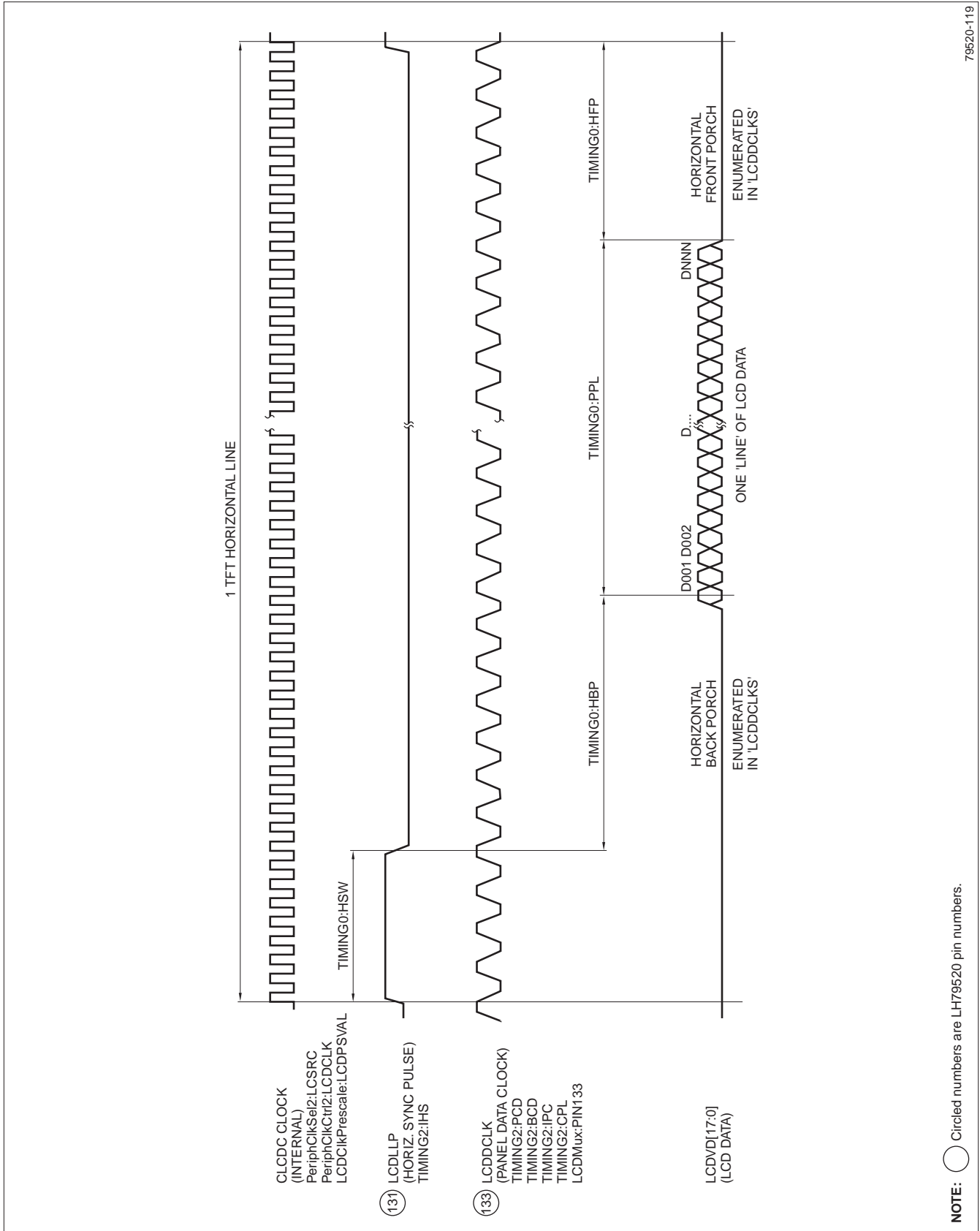

Figure 25. TFT Horizontal Timing Diagram

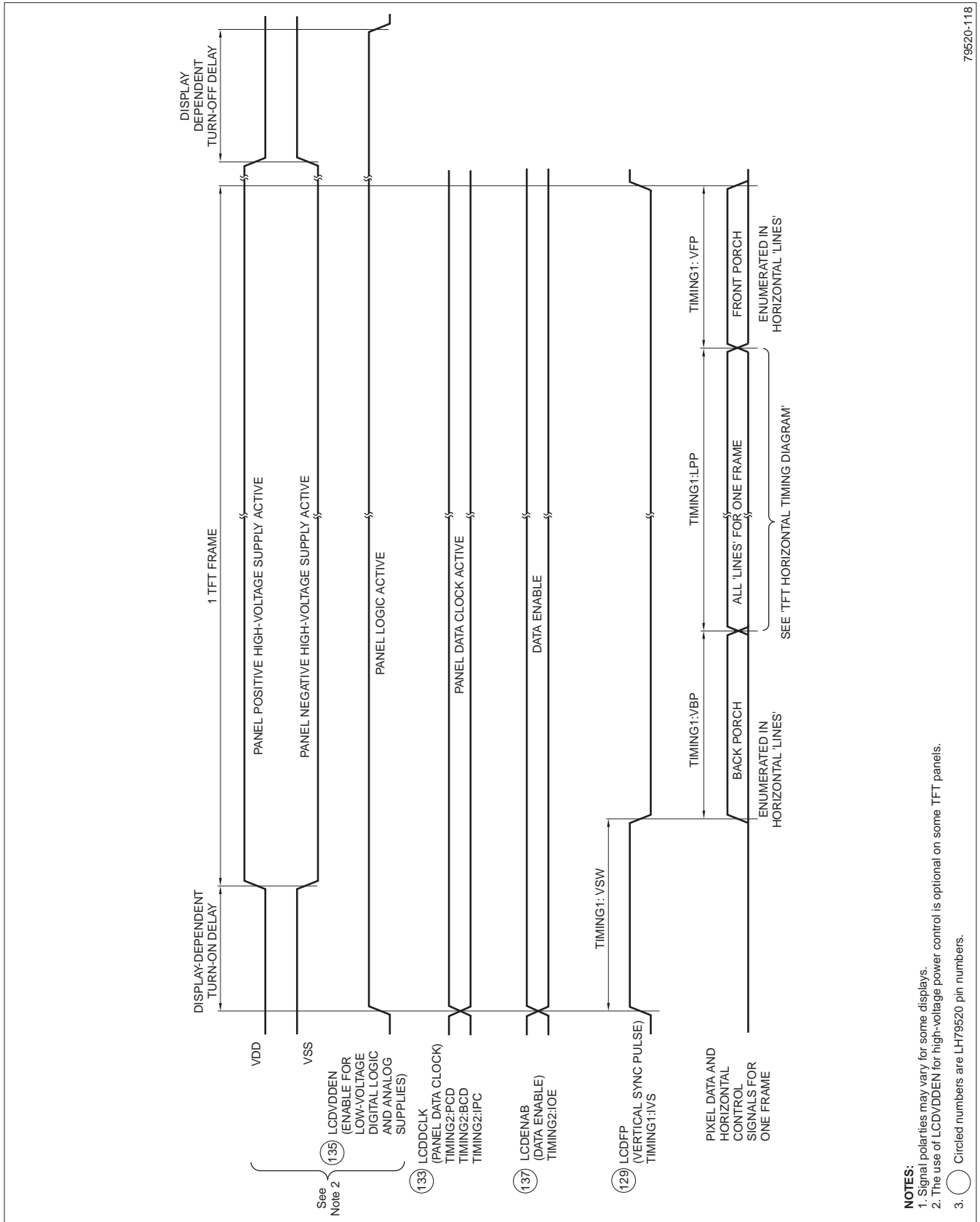

Figure 26. TFT Vertical Timing Diagram

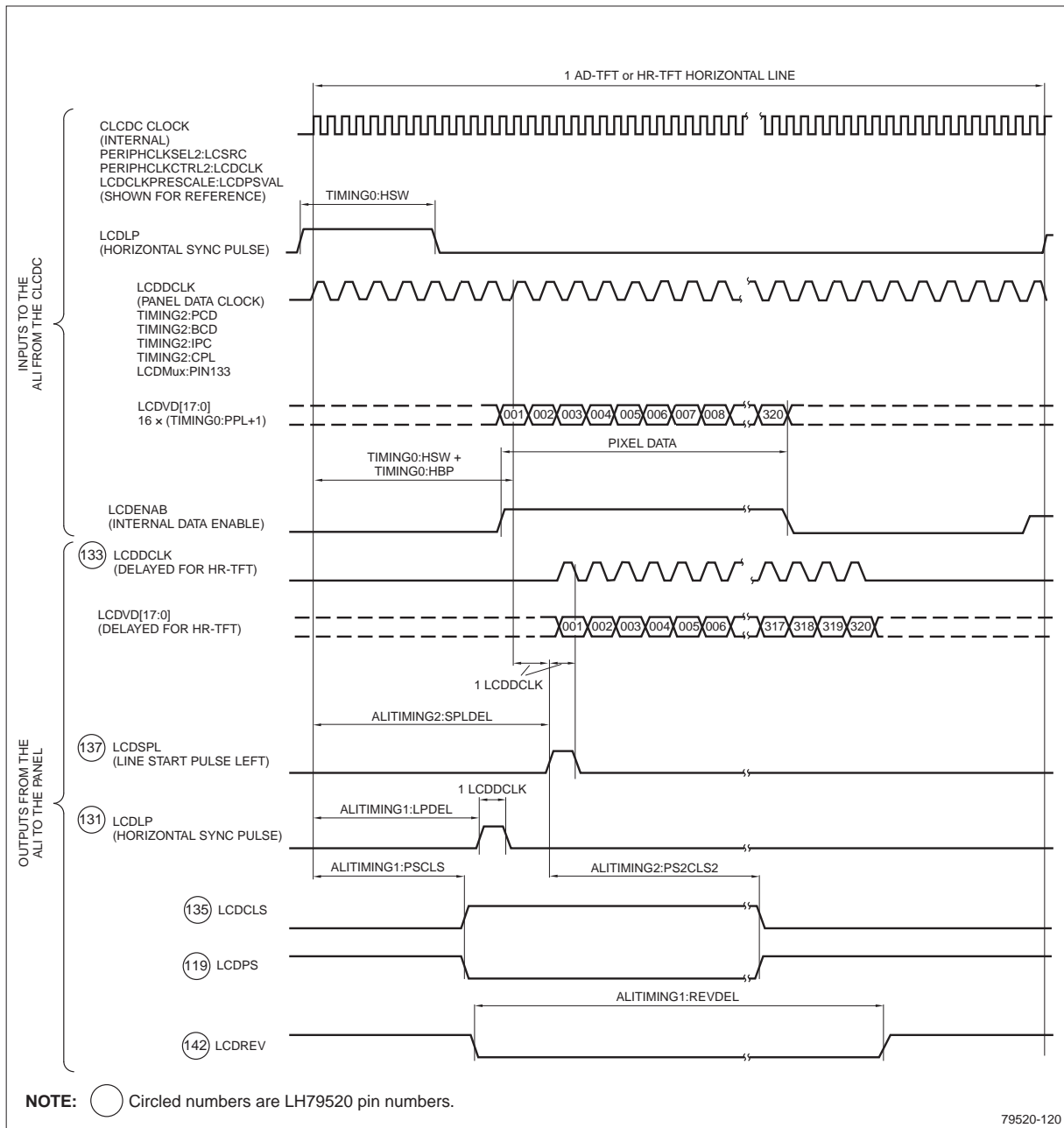

Figure 27. AD-TFT and HR-TFT Horizontal Timing Diagram

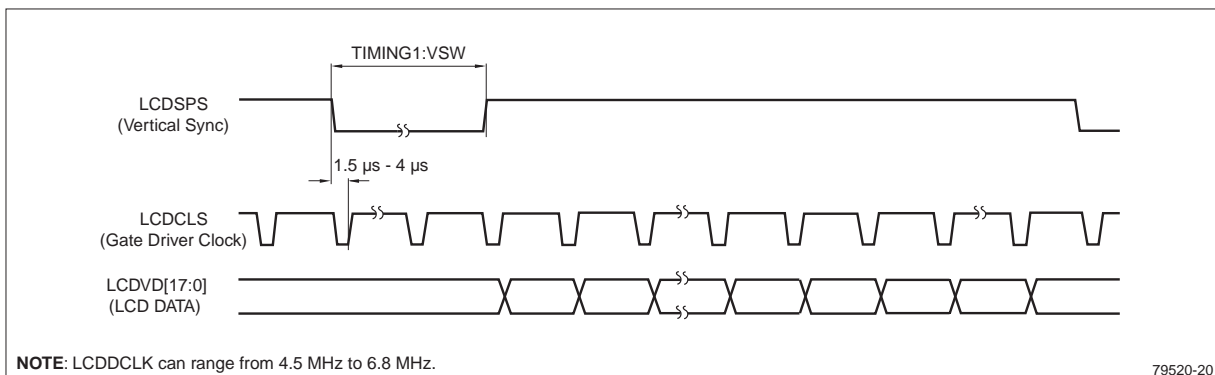

Figure 28. AD-TFT and HR-TFT Vertical Timing Diagram

Reset, Clock, and Power Controller (RCPC) Waveforms

Figure 29 shows the method the LH79520 uses when coming out of Reset or Power On.

Figure 30 shows external reset timing, and Table 13 gives the timing parameters.

Table 13. Reset AC Timing

PARAMETER	DESCRIPTION	MIN.	TYP.	MAX.	UNIT
tOSC32	Oscillator stabilization time after Power Up (VDDC = VDDCMIN)			550	ms
tOSC14	Oscillator stabilization time after Power Up (VDDC = VDDCMIN)			2.5	ms
tRSTIW	nRESETIN Pulse Width (once sampled LOW)	2			HCLK
tRSTOV	nRESETIN LOW to nRESETO valid (once nRESETIN sampled LOW)		3.5		HCLK
tRSTIH	nRESETIN hold extend to allow PLL to lock once XTAL is stable			10	μs
tRSTOH	nRESETO hold relative to nRESETIN HIGH		1		HCLK

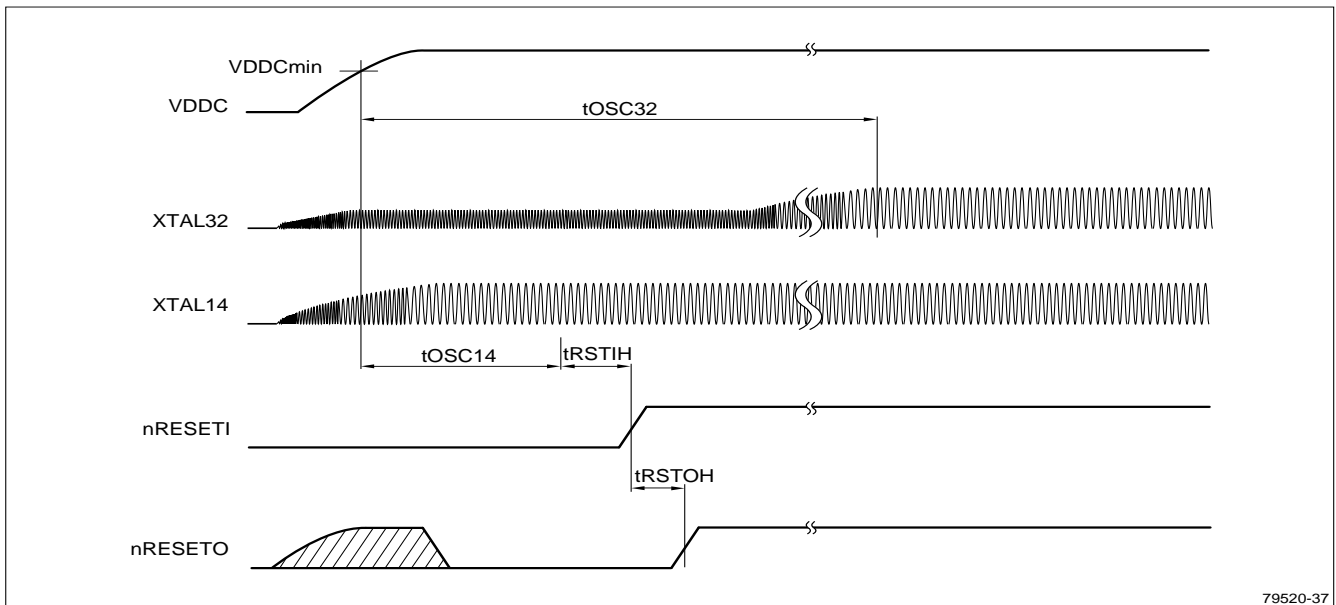

Figure 29. PLL Start-up

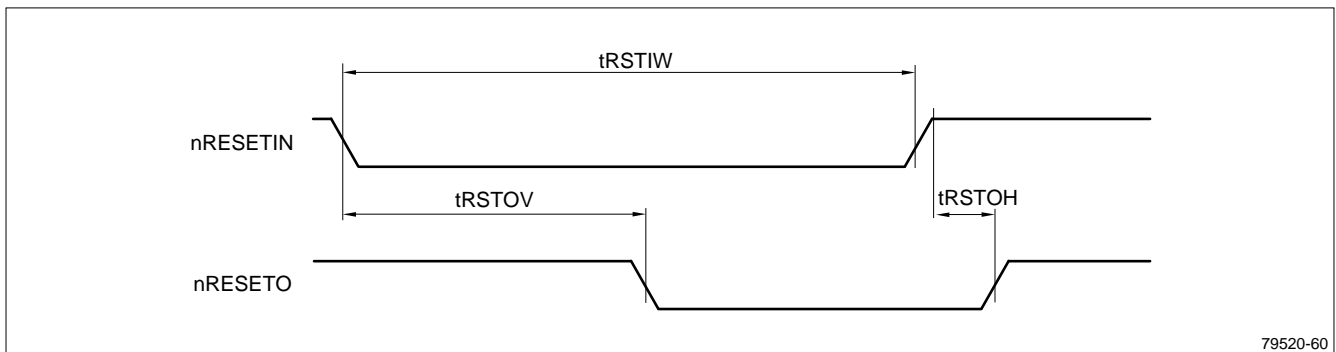

Figure 30. External Reset

Power Supply Sequencing

The 1.8 V power supply must be energized before the 3.3 V supply. Otherwise, the 1.8 V supply may not lag the 3.3 V supply by more than 10 μ s.

If a longer delay time is needed, the voltage difference between the two power supplies must be within 1.5 V during power supply ramp up.

To prevent a potential latch-up condition, voltage should only be applied to input pins after the device is powered-up as described above.

Low Operating Temperatures and Noise Immunity

The junction temperature, T_j , is the operating temperature of the transistors in the integrated circuit. The switching speed of the CMOS circuitry within the SoC depends partly on T_j , and the lower the operating temperature, the faster the CMOS circuits will switch. Increased switching noise generated by faster switching circuits could affect the overall system stability. The amount of switching noise is directly affected by the application executed on the SoC.

NXP recommends that users implementing a system to meet industrial temperature standards should use an external oscillator rather than a crystal to drive the system clock input of the System-on-Chip. This change from crystal to oscillator will increase the robustness (i.e., noise immunity of the clock input to the SoC).

Assuring Proper Reset Behavior

A separate reset for the TAP controller and power-on was designed into the LH79520 to give the Designer control over how the chip boots up and to be useful for bringing up software and hardware using E-ICE.

However, for the LH79520 to enter Normal mode, an initial reset pulse is required for the TAP controller when Power-on Reset is asserted.

Figure 31 illustrates one method for assuring proper TAP controller reset. This is a recommendation; Designers should assess their requirements and implement a solution that satisfies them.

This recommended circuit uses an external AND gate to AND the nRESETIN and nTRST signals, insuring that the TAP Controller gets reset with either signal, and the LH79520 always powers up in Normal Mode.

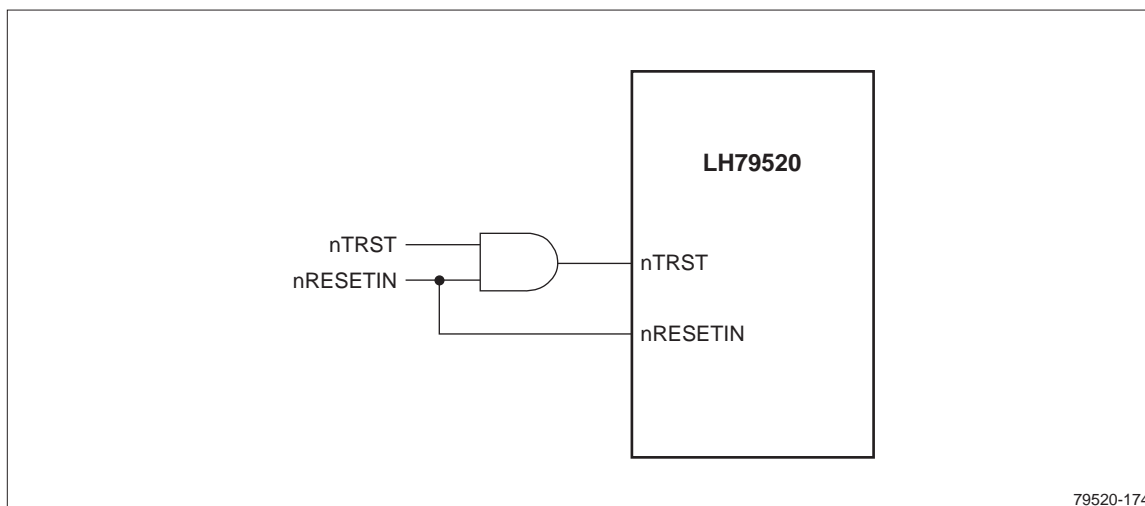

Figure 31. TAP Controller Reset Circuit Example

Printed Circuit Board Layout Practices

LH79520 POWER SUPPLY DECOUPLING

The LH79520 has separate power and ground pins for different internal circuitry sections. The VDD and VSS pins supply power to I/O buffers, while VDDC and VSSC supply power to the core logic.

Each of the VDD and VDDC pins must be provided with a low impedance path to the corresponding board power supply. Likewise, the VSS and VSSC pins must be provided with a low impedance path to the board ground.

Each power supply must be decoupled to ground using at least one 0.1 μF high frequency capacitor located as close as possible to a VDDx, VSSx pin pair on each of the four sides of the chip. If room on the circuit board allows, add one 0.01 μF high frequency capacitor near each VDDx, VSSx pair on the chip.

To be effective, the capacitor leads and associated circuit board traces connecting to the chip VDDx, VSSx pins must be kept to less than half an inch (12.7 mm) per capacitor lead. There must be one bulk 10 μF capacitor for each power supply placed near one side of the chip.

REQUIRED LH79520 PLL, VDDA, VSSA FILTER

The VDDA pin supplies power to the chip PLL circuitry. VSSA is the ground return path for the PLL circuit. If the internal PLL circuit will be used, these pins must have a low-pass filter attached as shown in Figure 32.

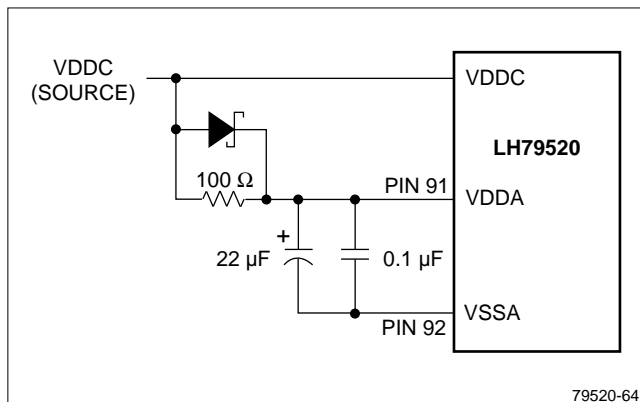

Figure 32. VDDA, VSSA Filter Circuit

The Schottky diode shown in the schematic must have a low forward drop specification, to allow VDDA to quickly transition through the entire input voltage range.

The power pin VDDA path must be a single wire from the IC package pin to the high frequency capacitor, then to the low frequency capacitor, and finally through the series resistor to the board power supply. The distance from the IC pin to the high frequency capacitor must be kept as short as possible.

Similarly, the VSSA path is from the IC pin to the high frequency capacitor, then to the low frequency capacitor, keeping the distance from the IC pin to the high frequency cap as short as possible.

CAUTION

Note that the VSSA pin specifically does not have a connection to the circuit board ground. The LH79520 PLL circuit has an internal DC ground connection to VSS (GND), so the external VSSA pin must NOT be connected to the circuit board ground, but only to the filter components.

UNUSED INPUT SIGNAL CONDITIONING

Floating input signals can cause excessive power consumption. Unused inputs which do not include internal pull-up or pull-down resistors should be pulled up or down externally, to tie the signal to its inactive state.

Some GPIO signals may default to inputs. If the pins which carry these signals are unused, software can program these signals as outputs, to eliminate the need for pull-ups or pull-downs. Power consumption may be higher than expected until such software executes.

Some LH79520 inputs have internal pull-ups or pull-downs. If unused, these inputs do not require external conditioning.

OTHER CIRCUIT BOARD LAYOUT PRACTICES

All output pins on the LH79520 have fast rise and fall times. Printed circuit trace interconnection length must therefore be reduced to minimize overshoot, undershoot and reflections caused by transmission line effects of these fast output switching times. This recommendation particularly applies to the address and data buses.

When considering capacitance, calculations must consider all device loads and capacitances due to the circuit board traces. Capacitance due to the traces will depend upon a number of factors, including the trace width, dielectric material the circuit board is made from and proximity to ground and power planes.

Attention to power supply decoupling and printed circuit board layout becomes more critical in systems with higher capacitive loads. As these capacitive loads increase, transient currents in the power supply and ground return paths also increase.

Add pull-up resistors to all unused inputs unless an internal pull-down resistor has been specified; see Table 3. (All pull-up/pull-down resistors must be 33 K Ω MAX.) Consider all signals that are Inputs at Reset time.

SUGGESTED EXTERNAL COMPONENTS

Figure 33 shows the suggested external components for the 32.768 kHz crystal circuit to be used with the NXP LH79520. The NAND gate represents the logic inside the SoC. See the chart for crystal specifics.

Figure 34 shows the suggested external components for the 14.7456 MHz crystal circuit to be used with the NXP LH79520. The NAND gate represents the logic inside the SoC. See the chart for crystal specifics.

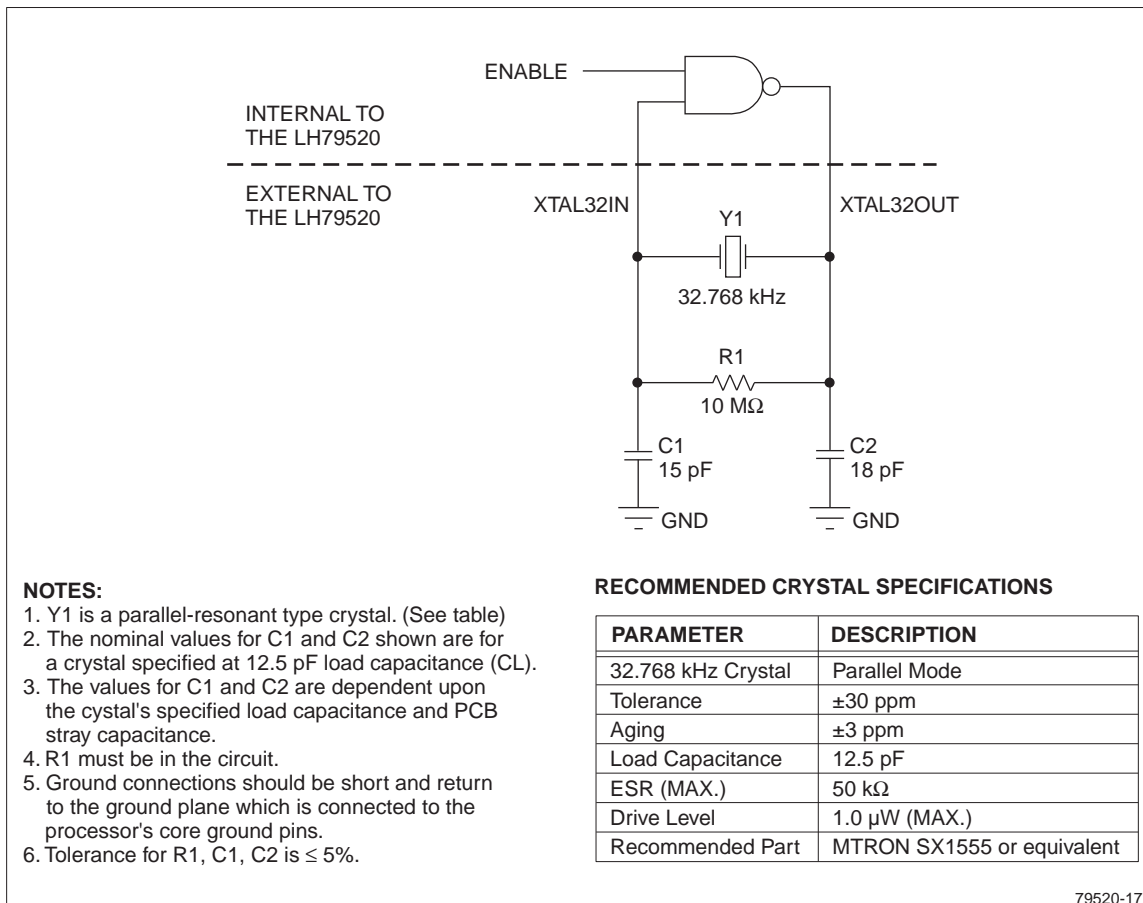

Figure 33. Suggested External Components, 32.768 kHz Oscillator (XTAL32IN and XTAL32OUT)

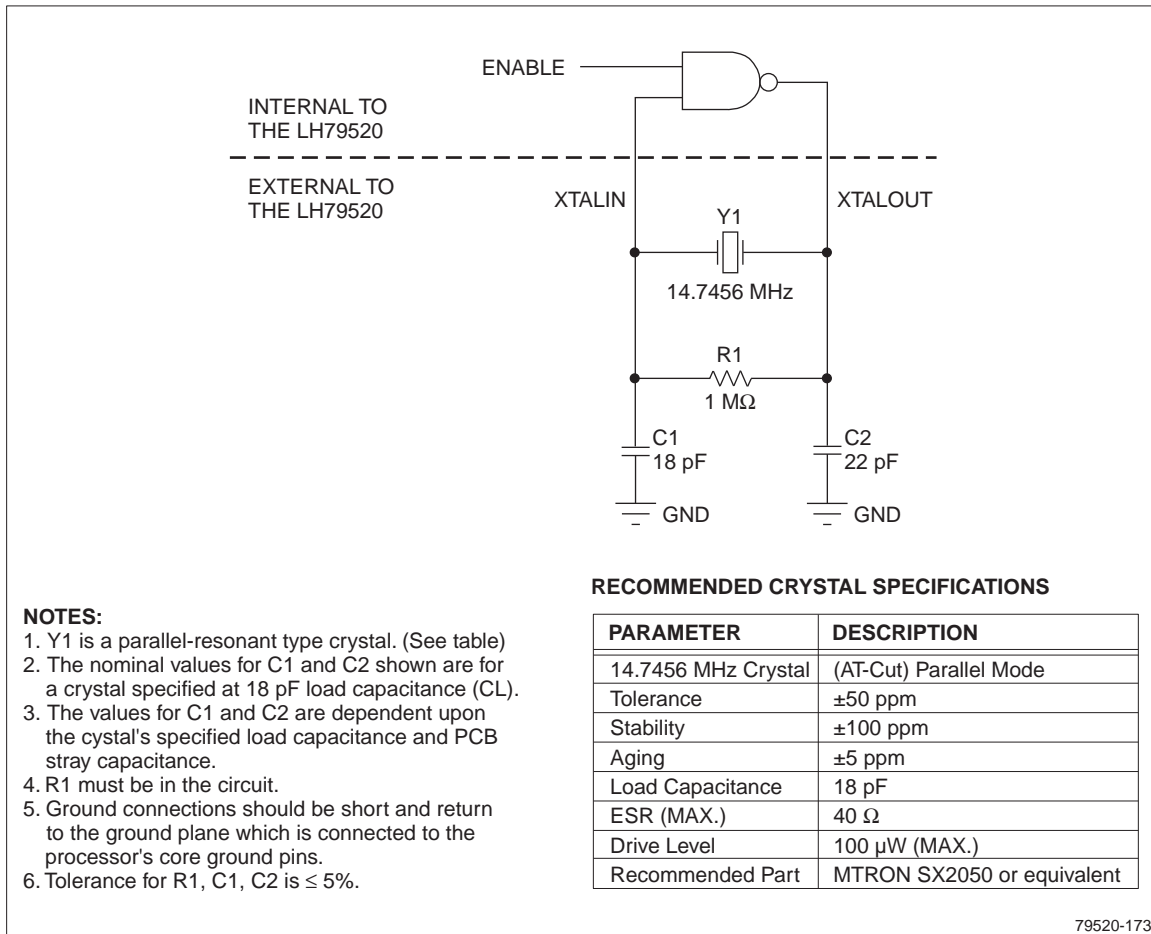

Figure 34. Suggested External Components, 14.7456 MHz Oscillator

PACKAGE SPECIFICATIONS

LQFP176: plastic low profile quad flat package; 176 leads; body 20 x 20 x 1.4 mm

SOT1017-1

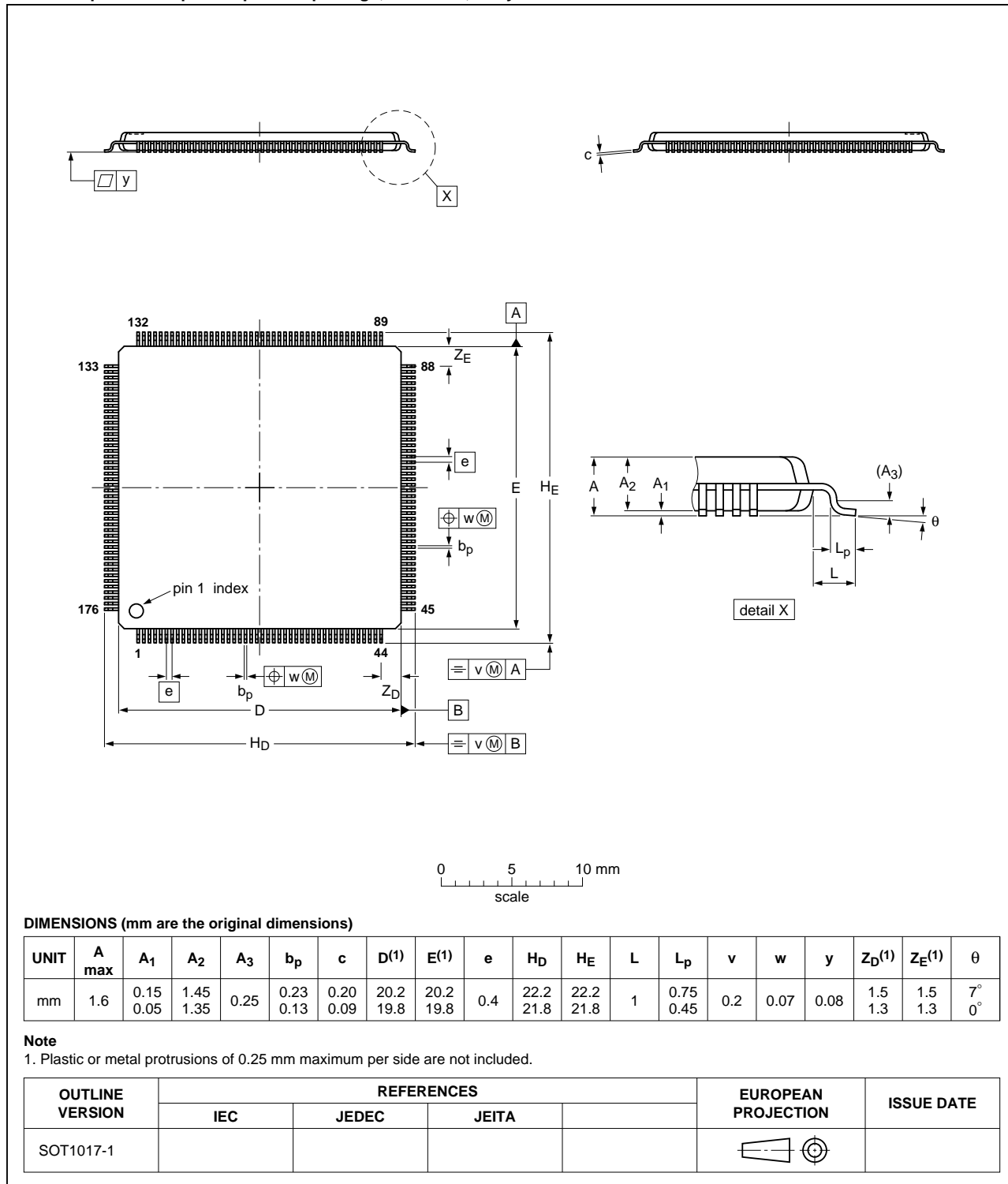

Figure 35. Package outline SOT1017-1 (LQFP176)

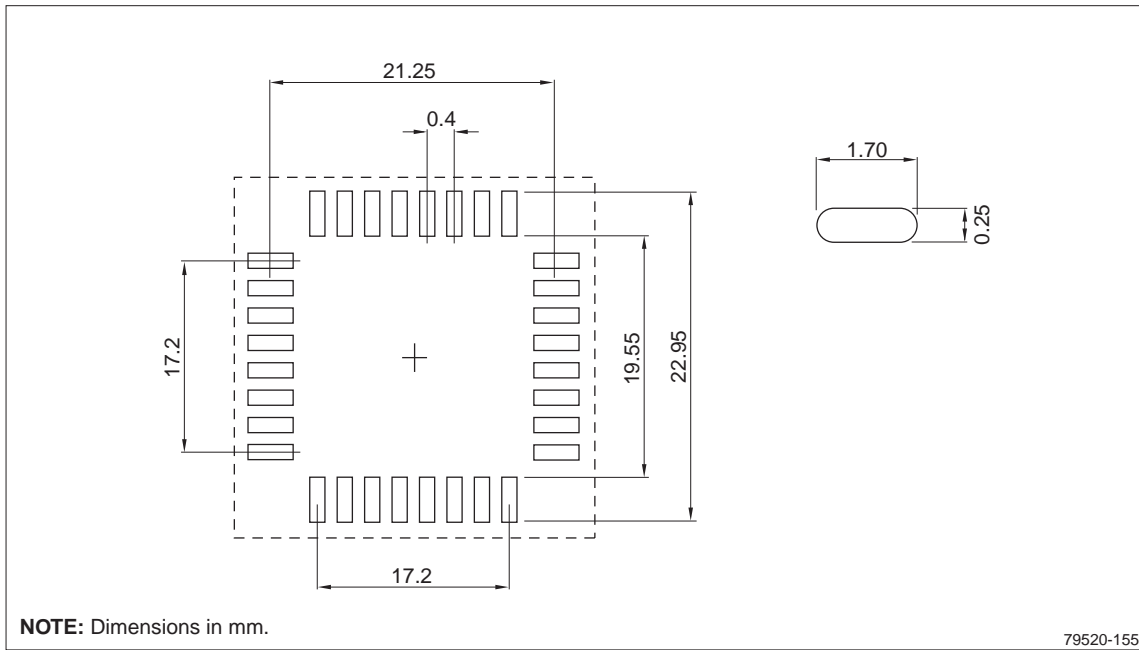

Figure 36. Recommended PCB Footprint

REVISION HISTORY**Table 14. Revision history**

Document ID	Release date	Data sheet status	Change notice	Supersedes
LH79520_N_2	20090319	Product data sheet	-	LH79520_N_1
Modifications: <ul style="list-style-type: none">• Changed document status to "Product data sheet".				
LH79520_N_1	20070716	Preliminary data sheet	-	LH79520 Data Sheet v1_3

1. Annex A - Legal information

1.1 Data sheet status

Document status ^{[1][2]}	Product status ^[3]	Definition
Objective [short] data sheet	Development	This document contains data from the objective specification for product development.
Preliminary [short] data sheet	Qualification	This document contains data from the preliminary specification.
Product [short] data sheet	Production	This document contains the product specification.

[1] Please consult the most recently issued document before initiating or completing a design.

[2] The term 'short data sheet' is explained in section "Definitions".

[3] The product status of device(s) described in this document may have changed since this document was published and may differ in case of multiple devices. The latest product status information is available on the Internet at URL <http://www.nxp.com>.

1.2 Definitions

Draft — The document is a draft version only. The content is still under internal review and subject to formal approval, which may result in modifications or additions. NXP Semiconductors does not give any representations or warranties as to the accuracy or completeness of information included herein and shall have no liability for the consequences of use of such information.

Short data sheet — A short data sheet is an extract from a full data sheet with the same product type number(s) and title. A short data sheet is intended for quick reference only and should not be relied upon to contain detailed and full information. For detailed and full information see the relevant full data sheet, which is available on request via the local NXP Semiconductors sales office. In case of any inconsistency or conflict with the short data sheet, the full data sheet shall prevail.

Product specification — The information and data provided in a Product data sheet shall define the specification of the product as agreed between NXP Semiconductors and its customer, unless NXP Semiconductors and customer have explicitly agreed otherwise in writing. In no event however, shall an agreement be valid in which the NXP Semiconductors product is deemed to offer functions and qualities beyond those described in the Product data sheet.

1.3 Disclaimers

Limited warranty and liability — Information in this document is believed to be accurate and reliable. However, NXP Semiconductors does not give any representations or warranties, expressed or implied, as to the accuracy or completeness of such information and shall have no liability for the consequences of use of such information. NXP Semiconductors takes no responsibility for the content in this document if provided by an information source outside of NXP Semiconductors.

In no event shall NXP Semiconductors be liable for any indirect, incidental, punitive, special or consequential damages (including - without limitation - lost profits, lost savings, business interruption, costs related to the removal or replacement of any products or rework charges) whether or not such damages are based on tort (including negligence), warranty, breach of contract or any other legal theory.

Notwithstanding any damages that customer might incur for any reason whatsoever, NXP Semiconductors' aggregate and cumulative liability towards customer for the products described herein shall be limited in accordance with the *Terms and conditions of commercial sale* of NXP Semiconductors.

Right to make changes — NXP Semiconductors reserves the right to make changes to information published in this document, including without limitation specifications and product descriptions, at any time and without notice. This document supersedes and replaces all information supplied prior to the publication hereof.

Suitability for use — NXP Semiconductors products are not designed, authorized or warranted to be suitable for use in life support, life-critical or safety-critical systems or equipment, nor in applications where failure or malfunction of an NXP Semiconductors product can reasonably be expected to result in personal injury, death or severe property or environmental

damage. NXP Semiconductors and its suppliers accept no liability for inclusion and/or use of NXP Semiconductors products in such equipment or applications and therefore such inclusion and/or use is at the customer's own risk.

Applications — Applications that are described herein for any of these products are for illustrative purposes only. NXP Semiconductors makes no representation or warranty that such applications will be suitable for the specified use without further testing or modification.

Customers are responsible for the design and operation of their applications and products using NXP Semiconductors products, and NXP Semiconductors accepts no liability for any assistance with applications or customer product design. It is customer's sole responsibility to determine whether the NXP Semiconductors product is suitable and fit for the customer's applications and products planned, as well as for the planned application and use of customer's third party customer(s). Customers should provide appropriate design and operating safeguards to minimize the risks associated with their applications and products.

NXP Semiconductors does not accept any liability related to any default, damage, costs or problem which is based on any weakness or default in the customer's applications or products, or the application or use by customer's third party customer(s). Customer is responsible for doing all necessary testing for the customer's applications and products using NXP Semiconductors products in order to avoid a default of the applications and the products or of the application or use by customer's third party customer(s). NXP does not accept any liability in this respect.

Limiting values — Stress above one or more limiting values (as defined in the Absolute Maximum Ratings System of IEC 60134) will cause permanent damage to the device. Limiting values are stress ratings only and (proper) operation of the device at these or any other conditions above those given in the Recommended operating conditions section (if present) or the Characteristics sections of this document is not warranted. Constant or repeated exposure to limiting values will permanently and irreversibly affect the quality and reliability of the device.

Terms and conditions of commercial sale — NXP Semiconductors products are sold subject to the general terms and conditions of commercial sale, as published at <http://www.nxp.com/profile/terms>, unless otherwise agreed in a valid written individual agreement. In case an individual agreement is concluded only the terms and conditions of the respective agreement shall apply. NXP Semiconductors hereby expressly objects to applying the customer's general terms and conditions with regard to the purchase of NXP Semiconductors products by customer.

No offer to sell or license — Nothing in this document may be interpreted or construed as an offer to sell products that is open for acceptance or the grant, conveyance or implication of any license under any copyrights, patents or other industrial or intellectual property rights.

Export control — This document as well as the item(s) described herein may be subject to export control regulations. Export might require a prior authorization from competent authorities.

Non-automotive qualified products — Unless this data sheet expressly states that this specific NXP Semiconductors product is automotive qualified, the product is not suitable for automotive use. It is neither qualified nor tested

in accordance with automotive testing or application requirements. NXP Semiconductors accepts no liability for inclusion and/or use of non-automotive qualified products in automotive equipment or applications.

In the event that customer uses the product for design-in and use in automotive applications to automotive specifications and standards, customer (a) shall use the product without NXP Semiconductors' warranty of the product for such automotive applications, use and specifications, and (b) whenever customer uses the product for automotive applications beyond NXP Semiconductors' specifications such use shall be solely at customer's own risk, and (c) customer fully indemnifies NXP Semiconductors for any liability,

damages or failed product claims resulting from customer design and use of the product for automotive applications beyond NXP Semiconductors' standard warranty and NXP Semiconductors' product specifications.

1.4 Trademarks

Notice: All referenced brands, product names, service names and trademarks are the property of their respective owners.

2. Contact information

For more information, please visit: <http://www.nxp.com>

For sales office addresses, please send an email to: salesaddresses@nxp.com