

# PVR100AZ-B series

Voltage regulator series

Rev. 01 — 16 November 2006

Product data sheet

## 1. Product profile

### 1.1 General description

Integrated Zener diode and NPN bipolar transistor in one package.

Table 1. Product overview

Type number	Package		SOT457 complement
	NXP	JEITA	
PVR100AZ-B2V5	SOT223	SC-73	PVR100AD-B2V5
PVR100AZ-B3V0			PVR100AD-B3V0
PVR100AZ-B3V3			PVR100AD-B3V3
PVR100AZ-B5V0			PVR100AD-B5V0
PVR100AZ-B12V			PVR100AD-B12V

### 1.2 Features

- Integrated Zener diode and bipolar transistor
- Output voltage options: 2.5 V, 3 V, 3.3 V, 5 V and 12 V
- Output power dissipation capability: 1.3 W
- Medium power Surface-Mounted Device (SMD) plastic package

### 1.3 Applications

- Linear voltage regulation

### 1.4 Quick reference data

Table 2. Quick reference data

Symbol	Parameter	Conditions	Min	Typ	Max	Unit
<b>NPN transistor</b>						
$V_{CE0}$	collector-emitter voltage	open base	-	-	45	V
$I_C$	collector current		-	-	0.1	A
$h_{FE}$	DC current gain	$V_{CE} = 1\text{ V}; I_C = 100\text{ mA}$	160	-	400	

Table 2. Quick reference data ...continued

Symbol	Parameter	Conditions	Min	Typ	Max	Unit
<b>Zener diode</b>						
$V_Z$	working voltage	$I_Z = 5 \text{ mA}$				
	PVR100AZ-B2V5		3.23	3.3	3.37	V
	PVR100AZ-B3V0		3.53	3.6	3.67	V
	PVR100AZ-B3V3		3.82	3.9	3.98	V
	PVR100AZ-B5V0		5.49	5.6	5.71	V
	PVR100AZ-B12V		12.7	13	13.3	V
<b>Voltage regulator</b>						
$V_O$	output voltage	$I_O = 10 \text{ mA}$				[1]
	PVR100AZ-B2V5	$V_I = 4.5 \text{ V}; I_{\text{ctrl}} = 3.5 \text{ mA}$	2.25	2.5	2.75	V
	PVR100AZ-B3V0	$V_I = 5 \text{ V}; I_{\text{ctrl}} = 6.5 \text{ mA}$	2.7	3	3.3	V
	PVR100AZ-B3V3	$V_I = 5.3 \text{ V}; I_{\text{ctrl}} = 6.5 \text{ mA}$	3.07	3.3	3.53	V
	PVR100AZ-B5V0	$V_I = 7 \text{ V}; I_{\text{ctrl}} = 10 \text{ mA}$	4.65	5	5.35	V
	PVR100AZ-B12V	$V_I = 14 \text{ V}; I_{\text{ctrl}} = 5 \text{ mA}$	11.4	12.3	13.2	V
<b>Line regulation</b>						
$\Delta V_O/V_O$	relative output voltage variation	$I_O = 10 \text{ mA}$				[1]
	PVR100AZ-B2V5	$4.5 \text{ V} \leq V_I \leq 40 \text{ V}; I_{\text{ctrl}} = 3.5 \text{ mA}$	-10	-	+10	%
	PVR100AZ-B3V0	$5 \text{ V} \leq V_I \leq 40 \text{ V}; I_{\text{ctrl}} = 6.5 \text{ mA}$	-10	-	+10	%
	PVR100AZ-B3V3	$5.3 \text{ V} \leq V_I \leq 40 \text{ V}; I_{\text{ctrl}} = 6.5 \text{ mA}$	-7	-	+7	%
	PVR100AZ-B5V0	$7 \text{ V} \leq V_I \leq 40 \text{ V}; I_{\text{ctrl}} = 10 \text{ mA}$	-7	-	+7	%
	PVR100AZ-B12V	$14 \text{ V} \leq V_I \leq 40 \text{ V}; I_{\text{ctrl}} = 5 \text{ mA}$	-7	-	+7	%
<b>Load regulation</b>						
$\Delta V_O/V_O$	relative output voltage variation	$5 \text{ mA} \leq I_O \leq 100 \text{ mA}$				[1]
	PVR100AZ-B2V5	$V_I = 4.5 \text{ V}; I_{\text{ctrl}} = 3.5 \text{ mA}$	-10	-	+10	%
	PVR100AZ-B3V0	$V_I = 5 \text{ V}; I_{\text{ctrl}} = 6.5 \text{ mA}$	-10	-	+10	%
	PVR100AZ-B3V3	$V_I = 5.3 \text{ V}; I_{\text{ctrl}} = 6.5 \text{ mA}$	-7	-	+7	%
	PVR100AZ-B5V0	$V_I = 7 \text{ V}; I_{\text{ctrl}} = 10 \text{ mA}$	-7	-	+7	%
	PVR100AZ-B12V	$V_I = 14 \text{ V}; I_{\text{ctrl}} = 5 \text{ mA}$	-7	-	+7	%

[1] Pulse test:  $t_p \leq 300 \mu\text{s}$ ;  $\delta \leq 0.02$ .

## 2. Pinning information

**Table 3. Pinning**

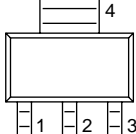
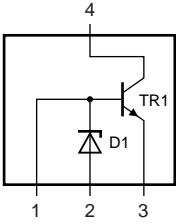
Pin	Symbol	Description	Simplified outline	Symbol
1	REXT	base		
2	GND	ground		
3	VO	output voltage		
4	VI	input voltage		

006aaa695

## 3. Ordering information

**Table 4. Ordering information**

Type number	Package		
	Name	Description	Version
PVR100AZ-B2V5	SC-73	plastic surface-mounted package with increased heat sink; 4 leads	SOT223
PVR100AZ-B3V0			
PVR100AZ-B3V3			
PVR100AZ-B5V0			
PVR100AZ-B12V			

## 4. Marking

**Table 5. Marking codes**

Type number	Marking code
PVR100AZ-B2V5	AZ-B2V5
PVR100AZ-B3V0	AZ-B3V0
PVR100AZ-B3V3	AZ-B3V3
PVR100AZ-B5V0	AZ-B5V0
PVR100AZ-B12V	AZ-B12V

## 5. Limiting values

**Table 6. Limiting values**

*In accordance with the Absolute Maximum Rating System (IEC 60134).*

Symbol	Parameter	Conditions	Min	Max	Unit	
<b>NPN transistor</b>						
$V_{CBO}$	collector-base voltage	open emitter	-	50	V	
$V_{CEO}$	collector-emitter voltage	open base	-	45	V	
$V_{EBO}$	emitter-base voltage	open collector	-	5	V	
$I_C$	collector current		-	0.1	A	
$I_{CM}$	peak collector current	single pulse; $t_p \leq 1$ ms	-	0.2	A	
$I_{BM}$	peak base current	single pulse; $t_p \leq 1$ ms	-	0.2	A	
$P_{tot}$	total power dissipation	$T_{amb} \leq 25$ °C	[1]	-	0.55	W
			[2]	-	1.2	W
			[3]	-	1.3	W
<b>Zener diode</b>						
$I_F$	forward current		-	200	mA	
$I_{ZSM}$	non-repetitive peak reverse current	$V_Z < 6$ V	-	6	A	
		$V_Z = 13$ V	-	2.5	A	
$P_{tot}$	total power dissipation	$T_{amb} \leq 25$ °C	[1]	-	0.15	W
<b>Voltage regulator</b>						
$P_{tot}$	total power dissipation	$T_{amb} \leq 25$ °C	[1]	-	0.65	W
			[2]	-	1.3	W
			[3]	-	1.5	W
$T_j$	junction temperature		-	150	°C	
$T_{amb}$	ambient temperature		-65	+150	°C	
$T_{stg}$	storage temperature		-65	+150	°C	

[1] Device mounted on an FR4 Printed-Circuit Board (PCB), single-sided copper, tin-plated and standard footprint.

[2] Device mounted on an FR4 PCB, single-sided copper, tin-plated, mounting pad for collector 6 cm<sup>2</sup>.

[3] Device mounted on a ceramic PCB, Al<sub>2</sub>O<sub>3</sub>, standard footprint.

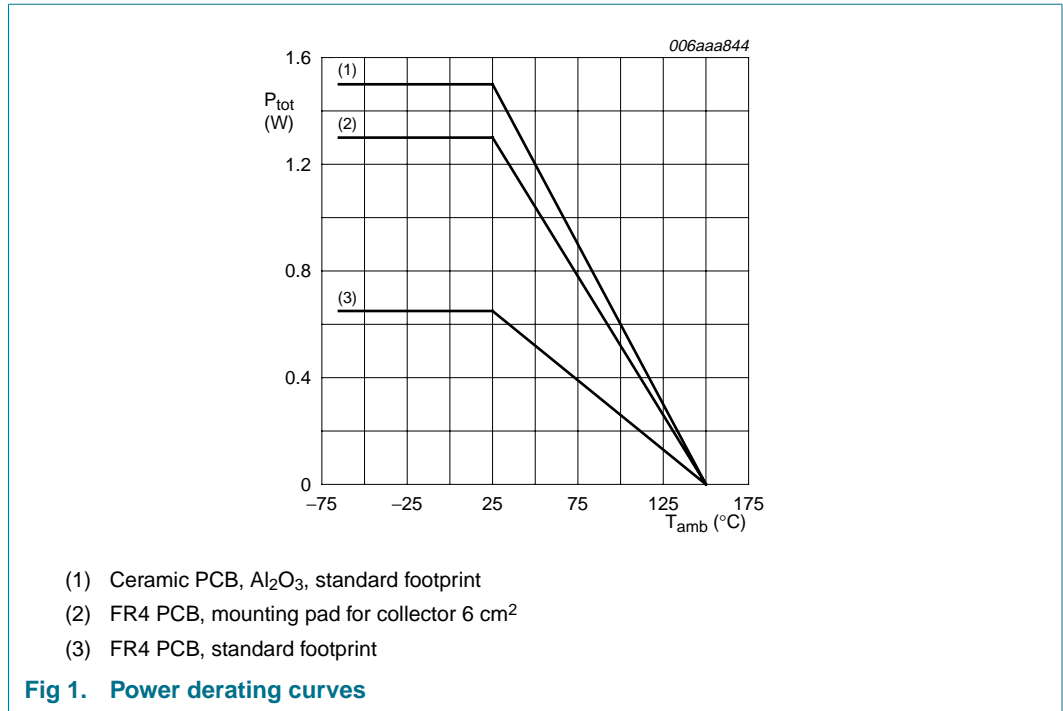

## 6. Thermal characteristics

**Table 7. Thermal characteristics**

Symbol	Parameter	Conditions	Min	Typ	Max	Unit	
<b>NPN transistor</b>							
R <sub>th(j-a)</sub>	thermal resistance from junction to ambient	in free air	[1]	-	-	227	K/W
			[2]	-	-	104	K/W
			[3]	-	-	96	K/W
R <sub>th(j-sp)</sub>	thermal resistance from junction to solder point		-	-	30	K/W	
<b>Zener diode</b>							
R <sub>th(j-a)</sub>	thermal resistance from junction to ambient	in free air	[1]	-	-	833	K/W
<b>Voltage regulator</b>							
R <sub>th(j-a)</sub>	thermal resistance from junction to ambient	in free air	[1]	-	-	192	K/W
			[2]	-	-	96	K/W
			[3]	-	-	83	K/W

[1] Device mounted on an FR4 PCB, single-sided copper, tin-plated and standard footprint.

[2] Device mounted on an FR4 PCB, single-sided copper, tin-plated, mounting pad for collector 6 cm<sup>2</sup>.

[3] Device mounted on a ceramic PCB, Al<sub>2</sub>O<sub>3</sub>, standard footprint.

## 7. Characteristics

**Table 8. Characteristics**
*T<sub>amb</sub> = 25 °C unless otherwise specified.*

Symbol	Parameter	Conditions	Min	Typ	Max	Unit	
<b>NPN transistor</b>							
I <sub>CBO</sub>	collector-base cut-off current	V <sub>CB</sub> = 20 V; I <sub>E</sub> = 0 A	-	-	100	nA	
		V <sub>CB</sub> = 20 V; I <sub>E</sub> = 0 A; T <sub>j</sub> = 150 °C	-	-	5	μA	
I <sub>EBO</sub>	emitter-base cut-off current	V <sub>EB</sub> = 5 V; I <sub>C</sub> = 0 A	-	-	100	nA	
h <sub>FE</sub>	DC current gain	V <sub>CE</sub> = 1 V; I <sub>C</sub> = 100 mA	160	-	400		
V <sub>BE</sub>	base-emitter voltage	V <sub>CE</sub> = 1 V; I <sub>C</sub> = 10 mA	-	0.72	-	V	
<b>Zener diode</b>							
V <sub>F</sub>	forward voltage	I <sub>F</sub> = 10 mA	-	-	0.9	V	
I <sub>R</sub>	reverse current	PVR100AZ-B2V5	V <sub>R</sub> = 1 V	-	-	5	μA
		PVR100AZ-B3V0	V <sub>R</sub> = 1 V	-	-	5	μA
		PVR100AZ-B3V3	V <sub>R</sub> = 1 V	-	-	3	μA
		PVR100AZ-B5V0	V <sub>R</sub> = 2 V	-	-	1	μA
		PVR100AZ-B12V	V <sub>R</sub> = 8 V	-	-	0.1	μA
		V <sub>Z</sub>	working voltage		I <sub>Z</sub> = 5 mA		
PVR100AZ-B2V5				3.23	3.3	3.37	V
PVR100AZ-B3V0				3.53	3.6	3.67	V
PVR100AZ-B3V3				3.82	3.9	3.98	V
PVR100AZ-B5V0				5.49	5.6	5.71	V
PVR100AZ-B12V				12.7	13	13.3	V
r <sub>dif</sub>	differential resistance		I <sub>Z</sub> = 1 mA				
		PVR100AZ-B2V5		-	350	600	Ω
		PVR100AZ-B3V0		-	375	600	Ω
		PVR100AZ-B3V3		-	400	600	Ω
		PVR100AZ-B5V0		-	80	400	Ω
		PVR100AZ-B12V		-	50	170	Ω
r <sub>dif</sub>	differential resistance		I <sub>Z</sub> = 5 mA				
		PVR100AZ-B2V5		-	85	95	Ω
		PVR100AZ-B3V0		-	85	90	Ω
		PVR100AZ-B3V3		-	85	90	Ω
		PVR100AZ-B5V0		-	15	40	Ω
		PVR100AZ-B12V		-	10	30	Ω

**Table 8. Characteristics ...continued**  
 $T_{amb} = 25\text{ }^{\circ}\text{C}$  unless otherwise specified.

Symbol	Parameter	Conditions	Min	Typ	Max	Unit
$S_z$	temperature coefficient	$I_z = 5\text{ mA}$				
	PVR100AZ-B2V5		-3.5	-2.4	0	mV/K
	PVR100AZ-B3V0		-3.5	-2.4	0	mV/K
	PVR100AZ-B3V3		-3.5	-2.5	0	mV/K
	PVR100AZ-B5V0		-2	1.2	2.5	mV/K
	PVR100AZ-B12V		7	9.4	11	mV/K

**Voltage regulator**

$V_O$	output voltage	$I_O = 10\text{ mA}$	<a href="#">[1]</a>			
	PVR100AZ-B2V5	$V_I = 4.5\text{ V};$ $I_{ctrl} = 3.5\text{ mA}$	2.25	2.5	2.75	V
	PVR100AZ-B3V0	$V_I = 5\text{ V};$ $I_{ctrl} = 6.5\text{ mA}$	2.7	3	3.3	V
	PVR100AZ-B3V3	$V_I = 5.3\text{ V};$ $I_{ctrl} = 6.5\text{ mA}$	3.07	3.3	3.53	V
	PVR100AZ-B5V0	$V_I = 7\text{ V};$ $I_{ctrl} = 10\text{ mA}$	4.65	5	5.35	V
	PVR100AZ-B12V	$V_I = 14\text{ V};$ $I_{ctrl} = 5\text{ mA}$	11.4	12.3	13.2	V

$\Delta V_O / (V_O \times \Delta T_{amb})$	relative output voltage variation over ambient temperature	$I_O = 100\text{ mA};$ $T_{amb} = -55\text{ }^{\circ}\text{C}$ to $150\text{ }^{\circ}\text{C}$	<a href="#">[1]</a>			
	PVR100AZ-B2V5	$V_I = 4.5\text{ V}$	-	38	-	$10^{-6}/\text{K}$
	PVR100AZ-B3V0	$V_I = 5\text{ V}$	-	-78	-	$10^{-6}/\text{K}$
	PVR100AZ-B3V3	$V_I = 5.3\text{ V}$	-	-61	-	$10^{-6}/\text{K}$
	PVR100AZ-B5V0	$V_I = 7\text{ V}$	-	634	-	$10^{-6}/\text{K}$
	PVR100AZ-B12V	$V_I = 14\text{ V}$	-	892	-	$10^{-6}/\text{K}$

**Line regulation**

$\Delta V_O / V_O$	relative output voltage variation	$I_O = 10\text{ mA}$	<a href="#">[1]</a>			
	PVR100AZ-B2V5	$4.5\text{ V} \leq V_I \leq 40\text{ V};$ $I_{ctrl} = 3.5\text{ mA}$	-10	-	+10	%
	PVR100AZ-B3V0	$5\text{ V} \leq V_I \leq 40\text{ V};$ $I_{ctrl} = 6.5\text{ mA}$	-10	-	+10	%
	PVR100AZ-B3V3	$5.3\text{ V} \leq V_I \leq 40\text{ V};$ $I_{ctrl} = 6.5\text{ mA}$	-7	-	+7	%
	PVR100AZ-B5V0	$7\text{ V} \leq V_I \leq 40\text{ V};$ $I_{ctrl} = 10\text{ mA}$	-7	-	+7	%
	PVR100AZ-B12V	$14\text{ V} \leq V_I \leq 40\text{ V};$ $I_{ctrl} = 5\text{ mA}$	-7	-	+7	%

**Table 8. Characteristics ...continued**  
 $T_{amb} = 25^{\circ}C$  unless otherwise specified.

Symbol	Parameter	Conditions	Min	Typ	Max	Unit
$\Delta V_O / (V_O \times \Delta V_I)$	relative output voltage variation over input voltage	$I_O = 10 \text{ mA}$	[1]			
	PVR100AZ-B2V5	$4.5 \text{ V} \leq V_I \leq 40 \text{ V};$ $I_{ctrl} = 3.5 \text{ mA}$	-	100	-	$10^{-6}/V$
	PVR100AZ-B3V0	$5 \text{ V} \leq V_I \leq 40 \text{ V};$ $I_{ctrl} = 6.5 \text{ mA}$	-	80	-	$10^{-6}/V$
	PVR100AZ-B3V3	$5.3 \text{ V} \leq V_I \leq 40 \text{ V};$ $I_{ctrl} = 6.5 \text{ mA}$	-	70	-	$10^{-6}/V$
	PVR100AZ-B5V0	$7 \text{ V} \leq V_I \leq 40 \text{ V};$ $I_{ctrl} = 10 \text{ mA}$	-	40	-	$10^{-6}/V$
	PVR100AZ-B12V	$14 \text{ V} \leq V_I \leq 40 \text{ V};$ $I_{ctrl} = 5 \text{ mA}$	-	20	-	$10^{-6}/V$
<b>Load regulation</b>						
$\Delta V_O / V_O$	relative output voltage variation	$5 \text{ mA} \leq I_O \leq 100 \text{ mA}$	[1]			
	PVR100AZ-B2V5	$V_I = 4.5 \text{ V};$ $I_{ctrl} = 3.5 \text{ mA}$	-10	-	+10	%
	PVR100AZ-B3V0	$V_I = 5 \text{ V};$ $I_{ctrl} = 6.5 \text{ mA}$	-10	-	+10	%
	PVR100AZ-B3V3	$V_I = 5.3 \text{ V};$ $I_{ctrl} = 6.5 \text{ mA}$	-7	-	+7	%
	PVR100AZ-B5V0	$V_I = 7 \text{ V};$ $I_{ctrl} = 10 \text{ mA}$	-7	-	+7	%
	PVR100AZ-B12V	$V_I = 14 \text{ V};$ $I_{ctrl} = 5 \text{ mA}$	-7	-	+7	%
$\Delta V_O / (V_O \times \Delta I_O)$	relative output voltage variation over output current	$5 \text{ mA} \leq I_O \leq 100 \text{ mA}$	[1]			
	PVR100AZ-B2V5	$V_I = 4.5 \text{ V};$ $I_{ctrl} = 3.5 \text{ mA}$	-	-840	-	$10^{-6}/\text{mA}$
	PVR100AZ-B3V0	$V_I = 5 \text{ V};$ $I_{ctrl} = 6.5 \text{ mA}$	-	-630	-	$10^{-6}/\text{mA}$
	PVR100AZ-B3V3	$V_I = 5.3 \text{ V};$ $I_{ctrl} = 6.5 \text{ mA}$	-	-540	-	$10^{-6}/\text{mA}$
	PVR100AZ-B5V0	$V_I = 7 \text{ V};$ $I_{ctrl} = 10 \text{ mA}$	-	-320	-	$10^{-6}/\text{mA}$
	PVR100AZ-B12V	$V_I = 14 \text{ V};$ $I_{ctrl} = 5 \text{ mA}$	-	-130	-	$10^{-6}/\text{mA}$

[1] Pulse test:  $t_p \leq 300 \mu\text{s}; \delta \leq 0.02$ .



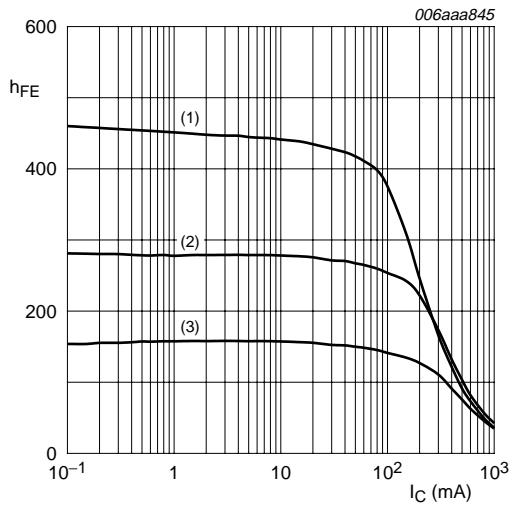

$V_{CE} = 1\text{ V}$   
 (1)  $T_{amb} = 150\text{ °C}$   
 (2)  $T_{amb} = 25\text{ °C}$   
 (3)  $T_{amb} = -55\text{ °C}$

**Fig 2. NPN transistor: DC current gain as a function of collector current; typical values**

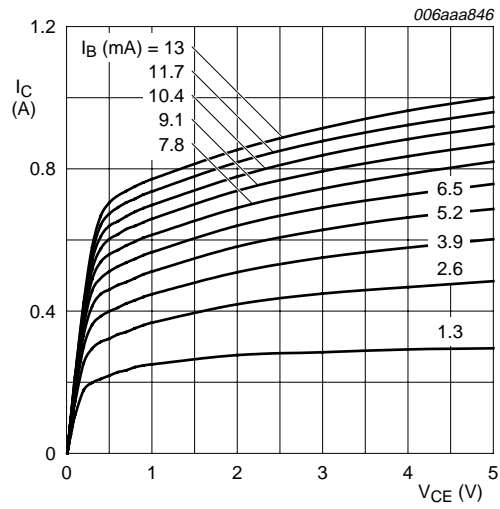

$T_{amb} = 25\text{ °C}$

**Fig 3. NPN transistor: Collector current as a function of collector-emitter voltage; typical values**

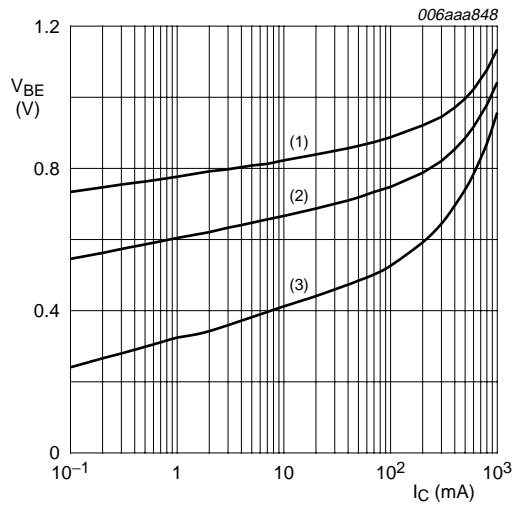

$V_{CE} = 1\text{ V}$   
 (1)  $T_{amb} = -55\text{ °C}$   
 (2)  $T_{amb} = 25\text{ °C}$   
 (3)  $T_{amb} = 150\text{ °C}$

**Fig 4. NPN transistor: Base-emitter voltage as a function of collector current; typical values**

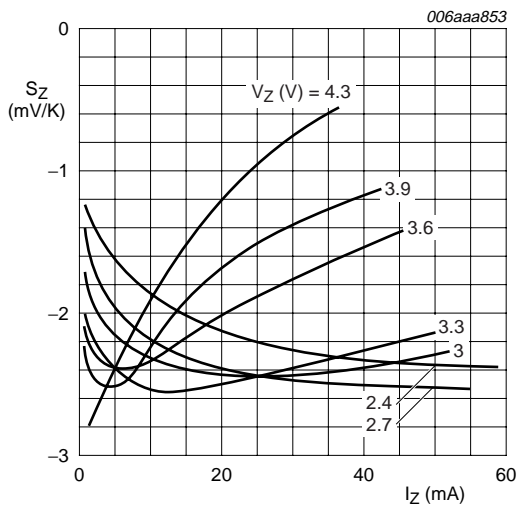

$T_j = 25\text{ }^\circ\text{C}$  to  $150\text{ }^\circ\text{C}$

**Fig 5. Zener diode: Temperature coefficient as a function of working current; typical values**

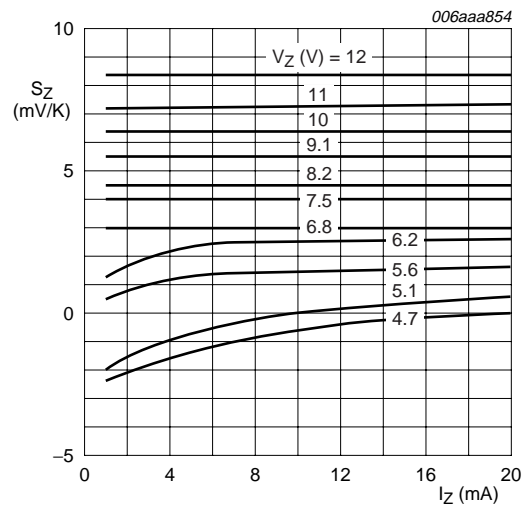

$T_j = 25\text{ }^\circ\text{C}$  to  $150\text{ }^\circ\text{C}$

**Fig 6. Zener diode: Temperature coefficient as a function of working current; typical values**

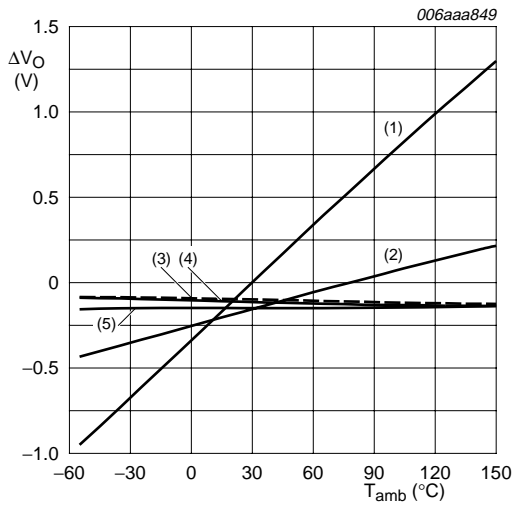

$V_I = V_{O(\text{typ})} + 2 \text{ V}$ ;  $I_O = 100 \text{ mA}$ ;  
 $T_{\text{amb}} = -55 \text{ }^\circ\text{C}$  to  $150 \text{ }^\circ\text{C}$

- (1) PVR100AZ-B12V
- (2) PVR100AZ-B5V0
- (3) PVR100AZ-B3V3
- (4) PVR100AZ-B3V0
- (5) PVR100AZ-B2V5

**Fig 7. Voltage regulator: Output voltage variation as a function of ambient temperature; typical values**

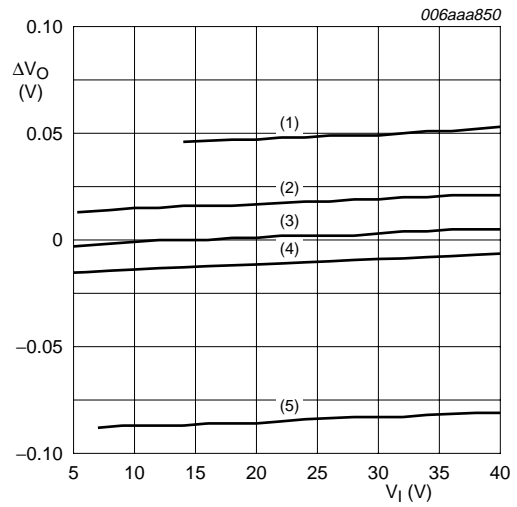

$T_{\text{amb}} = 25 \text{ }^\circ\text{C}$ ;  $I_O = 10 \text{ mA}$

- (1) PVR100AZ-B12V;  $I_{\text{ctrl}} = 5 \text{ mA}$
- (2) PVR100AZ-B3V3;  $I_{\text{ctrl}} = 6.5 \text{ mA}$
- (3) PVR100AZ-B3V0;  $I_{\text{ctrl}} = 6.5 \text{ mA}$
- (4) PVR100AZ-B2V5;  $I_{\text{ctrl}} = 3.5 \text{ mA}$
- (5) PVR100AZ-B5V0;  $I_{\text{ctrl}} = 10 \text{ mA}$

**Fig 8. Voltage regulator: Output voltage variation as a function of input voltage; typical values**

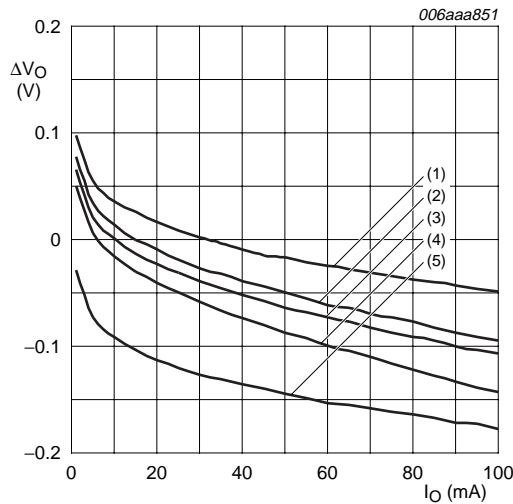

$T_{\text{amb}} = 25 \text{ }^\circ\text{C}$ ;  $V_I = V_{O(\text{typ})} + 2 \text{ V}$

- (1) PVR100AZ-B12V;  $I_{\text{ctrl}} = 5 \text{ mA}$
- (2) PVR100AZ-B3V3;  $I_{\text{ctrl}} = 6.5 \text{ mA}$
- (3) PVR100AZ-B3V0;  $I_{\text{ctrl}} = 6.5 \text{ mA}$
- (4) PVR100AZ-B2V5;  $I_{\text{ctrl}} = 3.5 \text{ mA}$
- (5) PVR100AZ-B5V0;  $I_{\text{ctrl}} = 10 \text{ mA}$

**Fig 9. Voltage regulator: Output voltage variation as a function of output current; typical values**

**8. Test information**

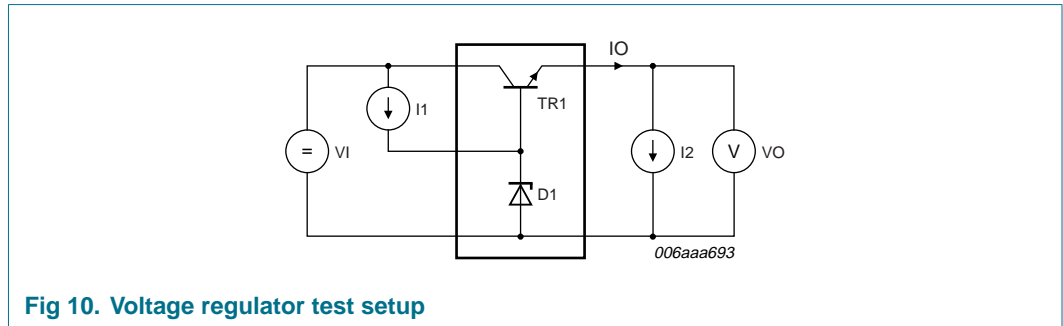

**Fig 10. Voltage regulator test setup**

**9. Package outline**

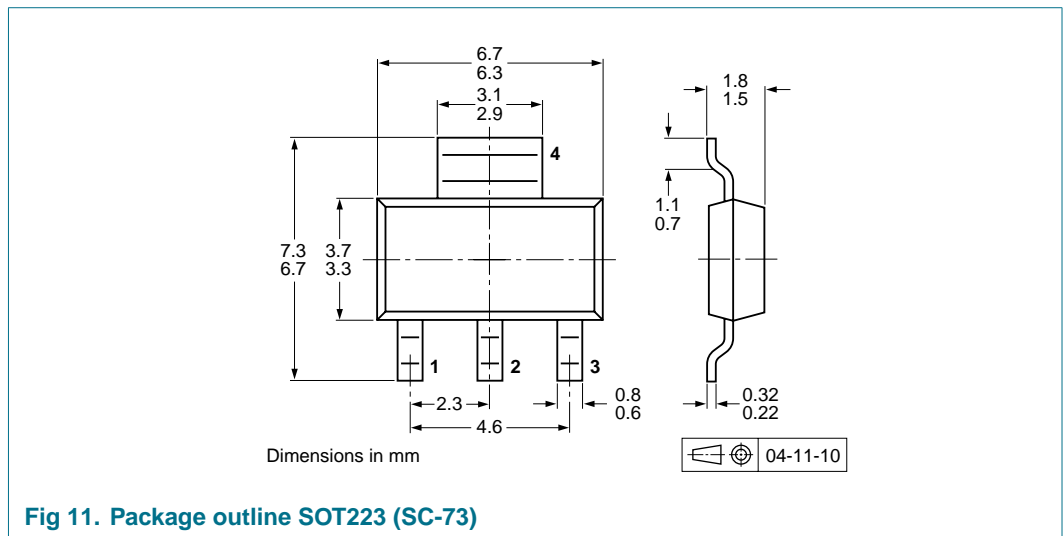

**Fig 11. Package outline SOT223 (SC-73)**

### 10. Packing information

**Table 9. Packing methods**

The indicated -xxx are the last three digits of the 12NC ordering code.<sup>[1]</sup>

Type number	Package	Description	Packing quantity	
			1000	4000
PVR100AZ-B2V5	SOT223	8 mm pitch, 12 mm tape and reel	-115	-135
PVR100AZ-B3V0				
PVR100AZ-B3V3				
PVR100AZ-B5V0				
PVR100AZ-B12V				

[1] For further information and the availability of packing methods, see [Section 14](#).

### 11. Soldering

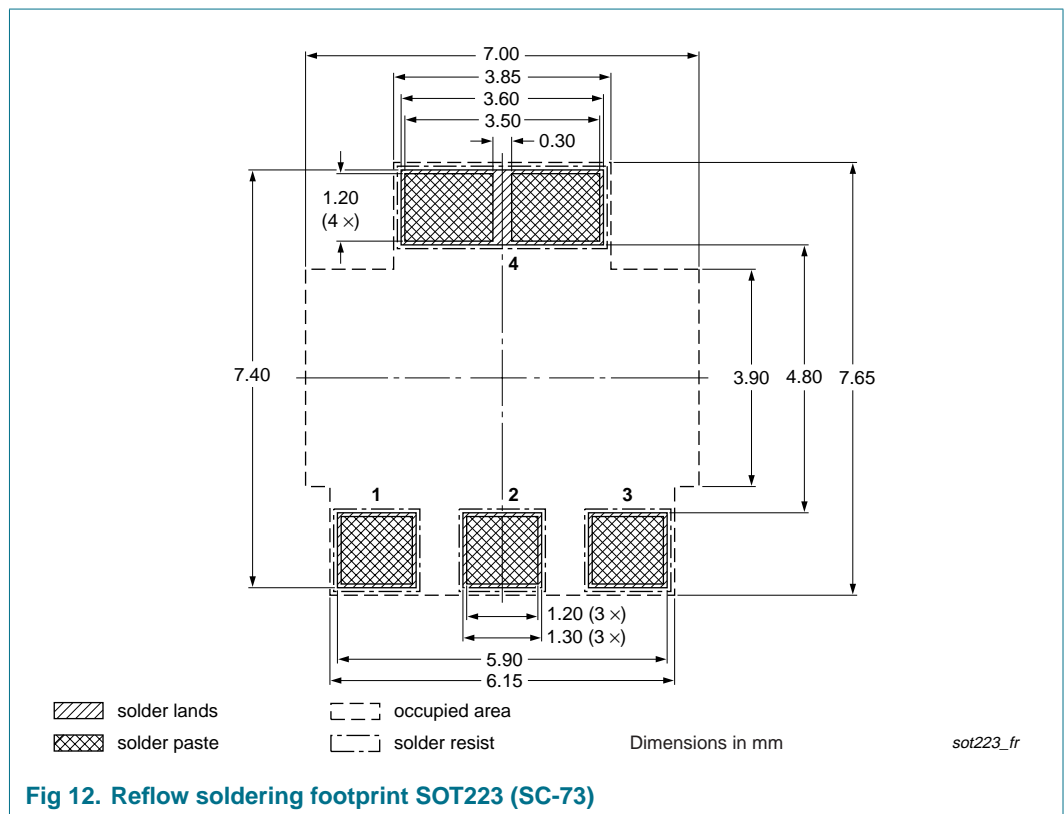

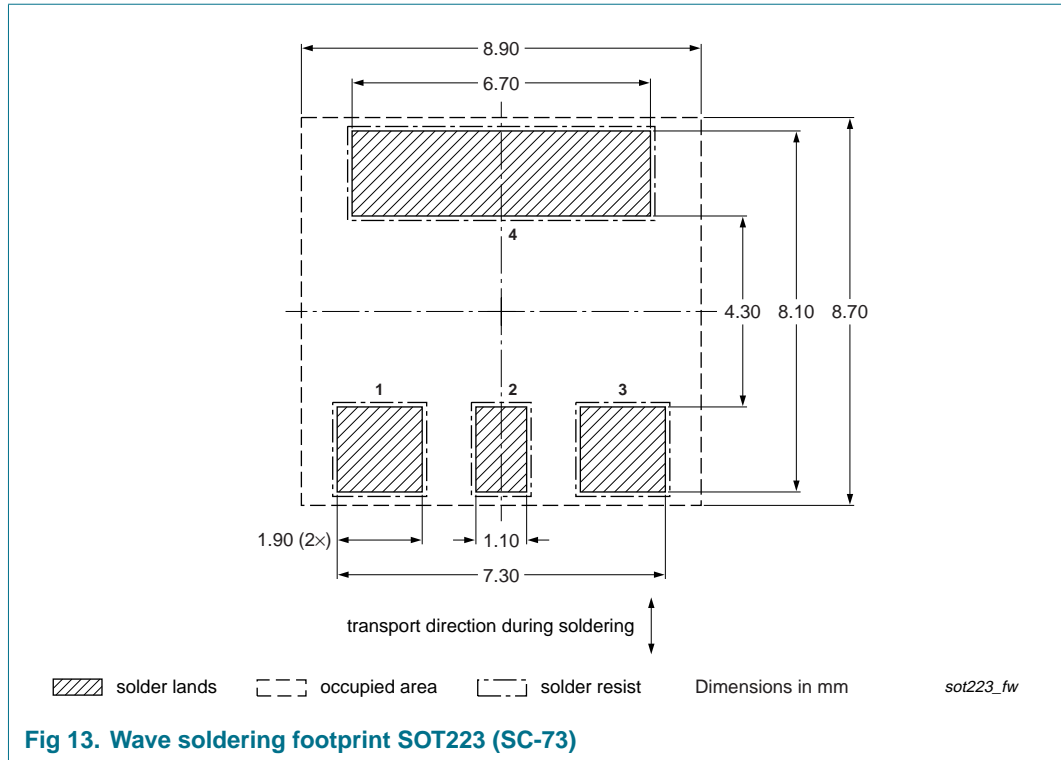

## 12. Revision history

Table 10. Revision history

Document ID	Release date	Data sheet status	Change notice	Supersedes
PVR100AZ-B_SER_1	20061116	Product data sheet	-	-

## 13. Legal information

### 13.1 Data sheet status

Document status <sup>[1][2]</sup>	Product status <sup>[3]</sup>	Definition
Objective [short] data sheet	Development	This document contains data from the objective specification for product development.
Preliminary [short] data sheet	Qualification	This document contains data from the preliminary specification.
Product [short] data sheet	Production	This document contains the product specification.

[1] Please consult the most recently issued document before initiating or completing a design.

[2] The term 'short data sheet' is explained in section "Definitions".

[3] The product status of device(s) described in this document may have changed since this document was published and may differ in case of multiple devices. The latest product status information is available on the Internet at URL <http://www.nxp.com>.

### 13.2 Definitions

**Draft** — The document is a draft version only. The content is still under internal review and subject to formal approval, which may result in modifications or additions. NXP Semiconductors does not give any representations or warranties as to the accuracy or completeness of information included herein and shall have no liability for the consequences of use of such information.

**Short data sheet** — A short data sheet is an extract from a full data sheet with the same product type number(s) and title. A short data sheet is intended for quick reference only and should not be relied upon to contain detailed and full information. For detailed and full information see the relevant full data sheet, which is available on request via the local NXP Semiconductors sales office. In case of any inconsistency or conflict with the short data sheet, the full data sheet shall prevail.

### 13.3 Disclaimers

**General** — Information in this document is believed to be accurate and reliable. However, NXP Semiconductors does not give any representations or warranties, expressed or implied, as to the accuracy or completeness of such information and shall have no liability for the consequences of use of such information.

**Right to make changes** — NXP Semiconductors reserves the right to make changes to information published in this document, including without limitation specifications and product descriptions, at any time and without notice. This document supersedes and replaces all information supplied prior to the publication hereof.

**Suitability for use** — NXP Semiconductors products are not designed, authorized or warranted to be suitable for use in medical, military, aircraft, space or life support equipment, nor in applications where failure or

malfunction of a NXP Semiconductors product can reasonably be expected to result in personal injury, death or severe property or environmental damage. NXP Semiconductors accepts no liability for inclusion and/or use of NXP Semiconductors products in such equipment or applications and therefore such inclusion and/or use is at the customer's own risk.

**Applications** — Applications that are described herein for any of these products are for illustrative purposes only. NXP Semiconductors makes no representation or warranty that such applications will be suitable for the specified use without further testing or modification.

**Limiting values** — Stress above one or more limiting values (as defined in the Absolute Maximum Ratings System of IEC 60134) may cause permanent damage to the device. Limiting values are stress ratings only and operation of the device at these or any other conditions above those given in the Characteristics sections of this document is not implied. Exposure to limiting values for extended periods may affect device reliability.

**Terms and conditions of sale** — NXP Semiconductors products are sold subject to the general terms and conditions of commercial sale, as published at <http://www.nxp.com/profile/terms>, including those pertaining to warranty, intellectual property rights infringement and limitation of liability, unless explicitly otherwise agreed to in writing by NXP Semiconductors. In case of any inconsistency or conflict between information in this document and such terms and conditions, the latter will prevail.

**No offer to sell or license** — Nothing in this document may be interpreted or construed as an offer to sell products that is open for acceptance or the grant, conveyance or implication of any license under any copyrights, patents or other industrial or intellectual property rights.

### 13.4 Trademarks

Notice: All referenced brands, product names, service names and trademarks are the property of their respective owners.

## 14. Contact information

For additional information, please visit: <http://www.nxp.com>

For sales office addresses, send an email to: [salesaddresses@nxp.com](mailto:salesaddresses@nxp.com)



**15. Contents**

**1 Product profile . . . . . 1**

1.1 General description . . . . . 1

1.2 Features . . . . . 1

1.3 Applications . . . . . 1

1.4 Quick reference data . . . . . 1

**2 Pinning information . . . . . 3**

**3 Ordering information . . . . . 3**

**4 Marking . . . . . 3**

**5 Limiting values . . . . . 4**

**6 Thermal characteristics . . . . . 5**

**7 Characteristics . . . . . 6**

**8 Test information . . . . . 12**

**9 Package outline . . . . . 12**

**10 Packing information . . . . . 13**

**11 Soldering . . . . . 13**

**12 Revision history . . . . . 15**

**13 Legal information . . . . . 16**

13.1 Data sheet status . . . . . 16

13.2 Definitions . . . . . 16

13.3 Disclaimers . . . . . 16

13.4 Trademarks . . . . . 16

**14 Contact information . . . . . 16**

**15 Contents . . . . . 17**

Please be aware that important notices concerning this document and the product(s) described herein, have been included in section 'Legal information'.



© NXP B.V. 2006.

All rights reserved.

For more information, please visit: <http://www.nxp.com>

For sales office addresses, please send an email to: [salesaddresses@nxp.com](mailto:salesaddresses@nxp.com)

Date of release: 16 November 2006

Document identifier: PVR100AZ-B\_SER\_1