

CS8122

2.0% 5.0 V, 750 mA Low Dropout Linear Regulator with Delayed RESET

The CS8122 is a precision 5.0 V linear regulator capable of sourcing in excess of 750 mA. The $\overline{\text{RESET}}$'s delay time is externally programmed using a discrete RC network. During power up, or when the output goes out of regulation, the $\overline{\text{RESET}}$ lead remains in the low state for the duration of the delay. This function is independent of the input voltage and will function correctly as long as the output voltage remains at or above 1.0 V. Hysteresis is included in the Delay and the $\overline{\text{RESET}}$ comparators to improve noise immunity. A latching discharge circuit is used to discharge the delay capacitor when it is triggered by a brief fault condition.

The regulator is protected against a variety of fault conditions: i.e. reverse battery, overvoltage, short circuit and thermal runaway conditions. The regulator is protected against voltage transients ranging from -50 V to $+40$ V. Short circuit current is limited to 1.2 A (typ).

The CS8122 is an improved replacement for the CS8126 and features a tighter tolerance on its output voltage (2.0% vs. 4.0%).

The CS8122 is packaged in a 5 lead TO-220 with copper tab. The copper tab can be connected to a heat sink if necessary.

Features

- 5.0 V $\pm 2.0\%$ Regulated Output
- Low Dropout Voltage (0.6 V @ 0.5 A)
- 750 mA Output Current Capability
- Externally Programmed $\overline{\text{RESET}}$ Delay
- Fault Protection
 - Reverse Battery
 - 60 V Load Dump
 - -50 V Reverse Transient
 - Short Circuit
 - Thermal Shutdown
- Pb-Free Packages are Available*

*For additional information on our Pb-Free strategy and soldering details, please download the ON Semiconductor Soldering and Mounting Techniques Reference Manual, SOLDERRM/D.



ON Semiconductor®

<http://onsemi.com>



TO-220
FIVE LEAD
T SUFFIX
CASE 314D

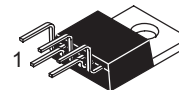

TO-220
FIVE LEAD
TVA SUFFIX
CASE 314K

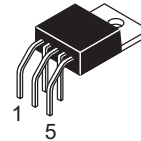

TO-220
FIVE LEAD
THA SUFFIX
CASE 314A

PIN CONNECTIONS

TO-220 5-LEAD

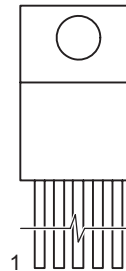

Pin 1. V_{IN}
2. V_{OUT}
3. GND
4. Delay
5. $\overline{\text{RESET}}$

DEVICE MARKING INFORMATION

See general marking information in the device marking section on page 2 of this data sheet.

ORDERING INFORMATION

See detailed ordering and shipping information in the package dimensions section on page 8 of this data sheet.

CS8122

MARKING DIAGRAMS

TO-220 5-LEAD

CASE 314D

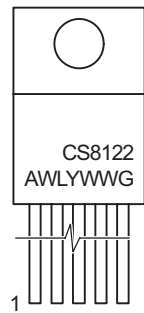

CASE 314K



CASE 314A

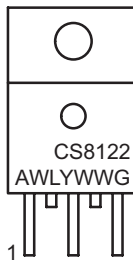

A = Assembly Location
 WL = Wafer Lot
 Y = Year
 WW = Work Week
 G = Pb-Free Package

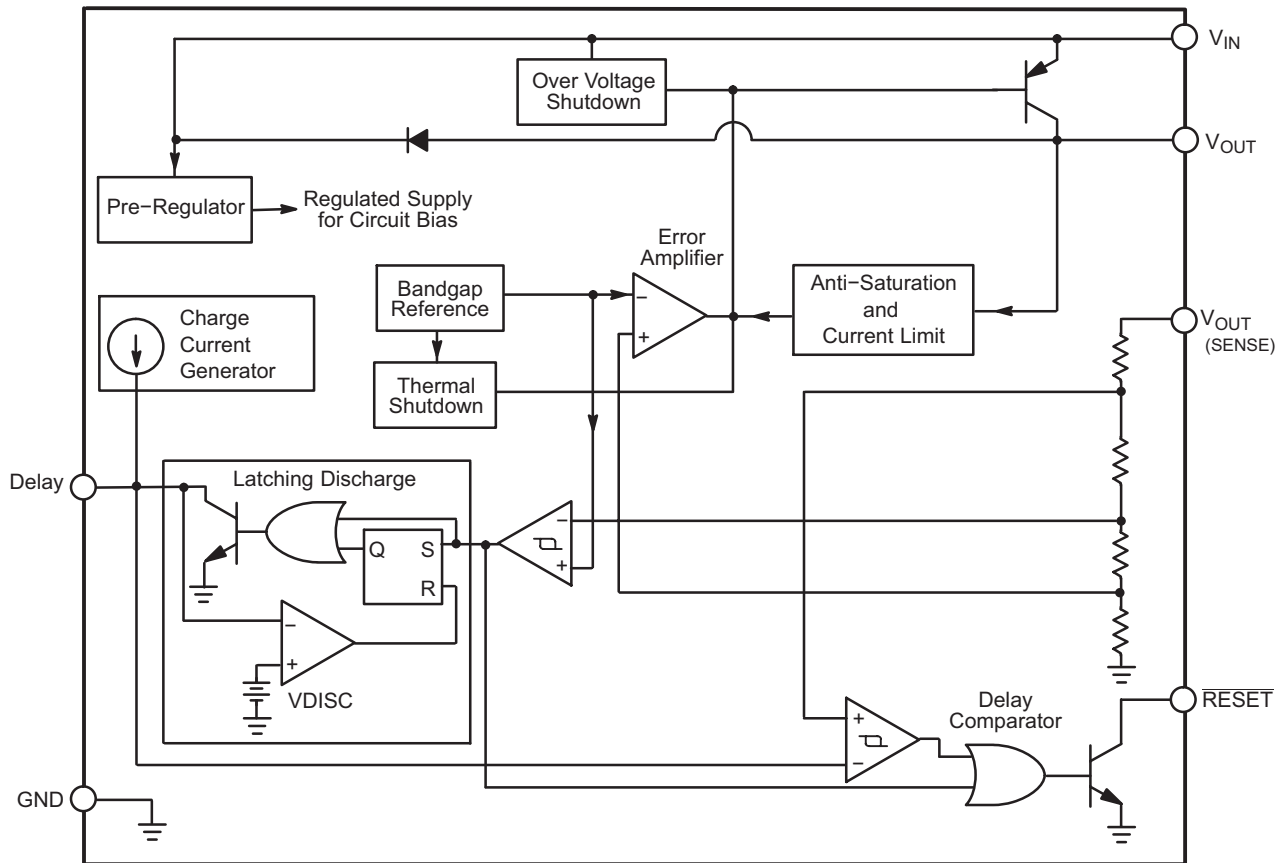

Figure 1. Block Diagram

ABSOLUTE MAXIMUM RATINGS

| Rating | Value | Unit |
|-----------------------------------------------------------|-------------------------------------------------|----------|
| Input Operating Range | -0.5 to 26 | V |
| Power Dissipation | Internally Limited | - |
| Peak Transient Voltage (46 V Load Dump @ $V_{IN} = 14$ V) | -50, 60 | V |
| Output Current | Internally Limited | - |
| Electrostatic Discharge (Human Body Model) | 4.0 | kV |
| Junction Temperature | -55 to +150 | °C |
| Storage Temperature Range | -55 to +150 | °C |
| Lead Temperature Soldering | Wave Solder (through hole styles only) (Note 1) | 260 peak |

Stresses exceeding Maximum Ratings may damage the device. Maximum Ratings are stress ratings only. Functional operation above the Recommended Operating Conditions is not implied. Extended exposure to stresses above the Recommended Operating Conditions may affect device reliability.

1. 10-second maximum.

ELECTRICAL CHARACTERISTICS ($-40^{\circ}\text{C} \leq T_A \leq 125^{\circ}\text{C}$, $-40 \leq T_J \leq 150^{\circ}\text{C}$, $6.0 \leq V_{IN} \leq 26$ V, $5.0 \text{ mA} \leq I_{OUT} \leq 500$ mA, $R_{RESET} = 4.7 \text{ k}\Omega$ to V_{CC} unless otherwise noted.) (Note 2)

| Characteristic | Test Conditions | Min | Typ | Max | Unit |
|----------------|-----------------|-----|-----|-----|------|
|----------------|-----------------|-----|-----|-----|------|

OUTPUT STAGE (V_{OUT})

| | | | | | |
|------------------------------------------|------------------------------------------------------------------------|-------------|------------------|------------------|----------------|
| Output Voltage | - | 4.9 | 5.0 | 5.1 | V |
| Dropout Voltage | $I_{OUT} = 500$ mA | - | 0.35 | 0.60 | V |
| Supply Current | $I_{OUT} \leq 10$ mA $I_{OUT} \leq 100$ mA $I_{OUT} \leq 500$ mA | - - - | 2.0 6.0 55 | 7.0 12 100 | mA mA mA |
| Line Regulation | $6.0 \text{ V} \leq V_{IN} \leq 26$ V, $I_{OUT} = 50$ mA | - | 5.0 | 50 | mV |
| Load Regulation | $50 \text{ mA} \leq I_{OUT} \leq 500$ mA, $V_{IN} = 14$ V | - | 10 | 50 | mV |
| Ripple Rejection | $f = 120$ Hz, $7.0 \leq V_{IN} \leq 17$ V, $I_{OUT} = 250$ mA | 54 | 75 | - | dB |
| Current Limit | - | 0.75 | 1.20 | - | A |
| Overshoot Shutdown | - | 32 | - | 40 | V |
| Maximum Line Transient | $V_{OUT} \leq 5.5$ V | 60 | 95 | - | V |
| Reverse Polarity Input Voltage DC | $V_{OUT} \geq -0.6$ V, 10Ω Load | -15 | -30 | - | V |
| Reverse Polarity Input Voltage Transient | 1.0% Duty Cycle, $T < 100$ ms, 10Ω Load | -50 | -80 | - | V |
| Thermal Shutdown | Guaranteed by Design | 150 | 180 | 210 | °C |

RESET AND DELAY FUNCTIONS

| | | | | | |
|-----------------------------------|----------------------------------------------------------------------------|--------------|--------------|--------------------------------------|---------------|
| Delay Charge Current | $V_{DELAY} = 2.0$ V | 5.0 | 10 | 15 | μA |
| RESET Threshold | V_{OUT} Increasing, $V_{RT(ON)}$ V_{OUT} Decreasing, $V_{RT(OFF)}$ | 4.65 4.50 | 4.90 4.70 | $V_{OUT} - 0.01$ $V_{OUT} - 0.16$ | V V |
| RESET Hysteresis | $V_{RH} = V_{RT(ON)} - V_{RT(OFF)}$ | 150 | 200 | 250 | mV |
| Delay Threshold | Charge, $V_{DC(HI)}$ Discharge, $V_{DC(L)}$ | 3.25 2.85 | 3.50 3.10 | 3.75 3.35 | V V |
| Delay Hysteresis | - | 200 | 400 | 800 | mV |
| RESET Output Voltage Low | $1.0 \text{ V} < V_{OUT} < V_{RT(L)}$, $3.0 \text{ k}\Omega$ to V_{OUT} | - | 0.1 | 0.4 | V |
| RESET Output Leakage | $V_{OUT} > V_{RT(H)}$ | 0 | - | 10 | μA |
| Delay Capacitor Discharge Voltage | Discharge Latched "ON", $V_{OUT} > V_{RT}$ | - | 0.2 | 0.5 | V |
| Delay Time | $C_{DELAY} = 0.1 \mu\text{F}$ | 16 | 32 | 48 | ms |

2. To observe safe operating junction temperatures, low duty cycle pulse testing is used in tests where applicable.

$$\text{Delay Time} = \frac{C_{\text{Delay}} \times V_{\text{Delay Threshold Charge}}}{I_{\text{Charge}}} = C_{\text{Delay}} \times 3.5 \times 10^5 \text{ (typ)}$$

PACKAGE LEAD DESCRIPTION

| PACKAGE LEAD # TO-220 5 LEAD | LEAD SYMBOL | FUNCTION |
|---------------------------------|------------------|---------------------------------------------------------------------------------------------------------------------|
| 1 | V _{IN} | Unregulated supply voltage to IC. |
| 2 | V _{OUT} | Regulated 5.0 V output. |
| 3 | GND | Ground Connection. |
| 4 | Delay | Timing capacitor for RESET function. |
| 5 | RESET | CMOS/TTL compatible output lead. RESET goes low whenever V _{OUT} drops below 6.0% of it's regulated value. |

TYPICAL PERFORMANCE CHARACTERISTICS

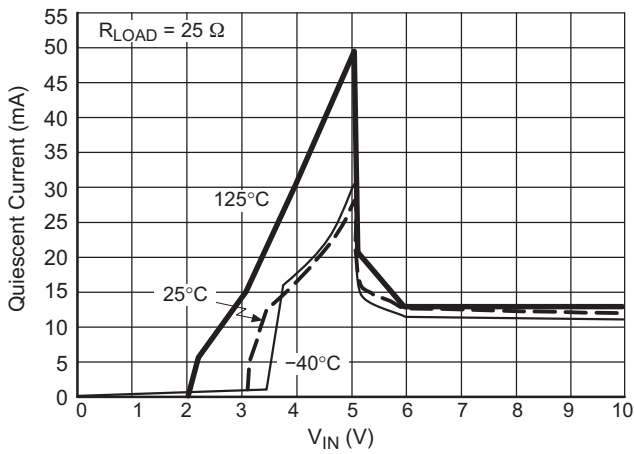

Figure 2. Quiescent Current vs. Input Voltage Over Temperature

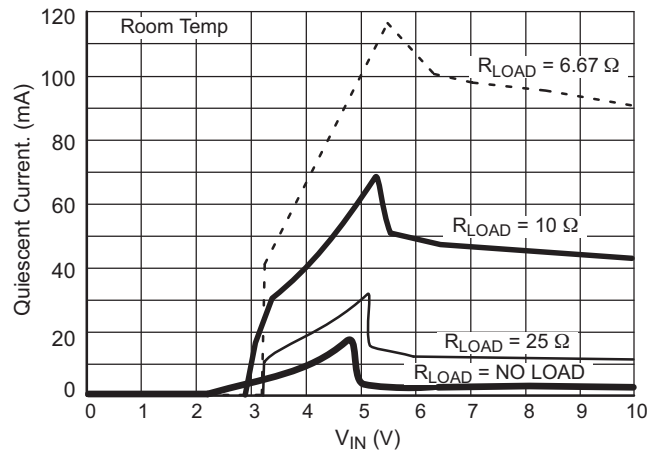

Figure 3. Quiescent Current vs. Input Voltage Over Load Resistance

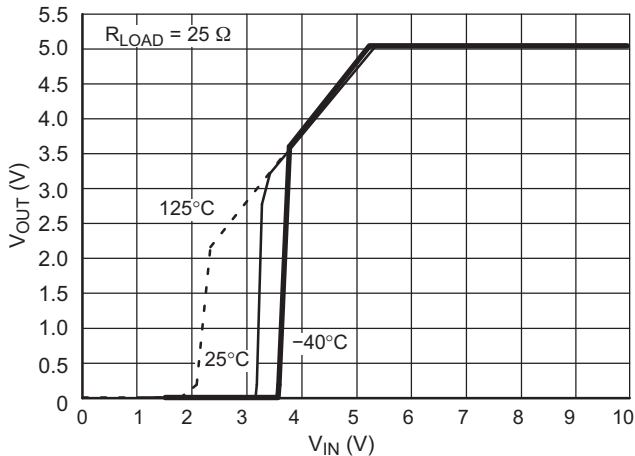

Figure 4. Output Voltage vs. Input Voltage Over Temperature

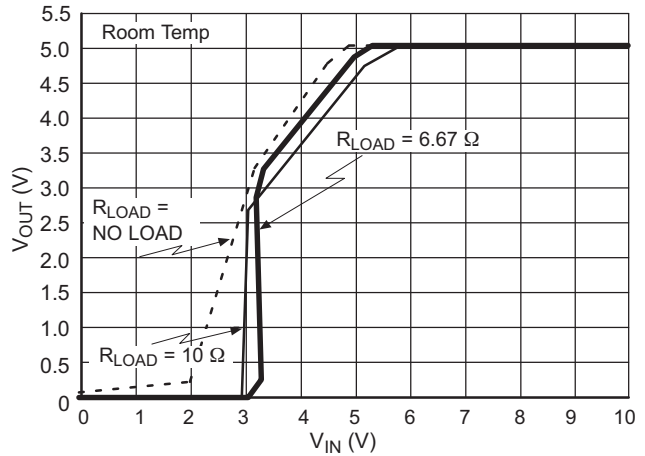

Figure 5. V_{OUT} vs. V_{IN} Over R_{LOAD}

TYPICAL PERFORMANCE CHARACTERISTICS

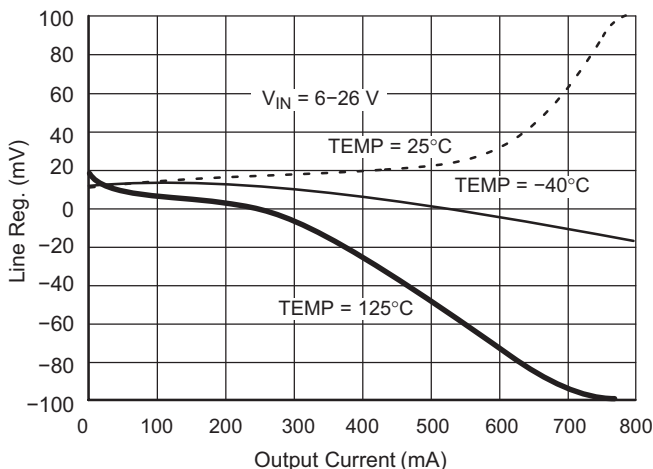

Figure 6. Line Regulation vs. Output Current

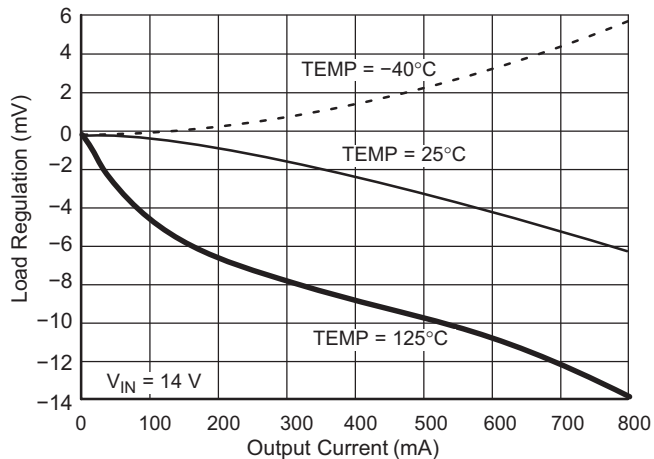

Figure 7. Load Regulation vs. Output Current

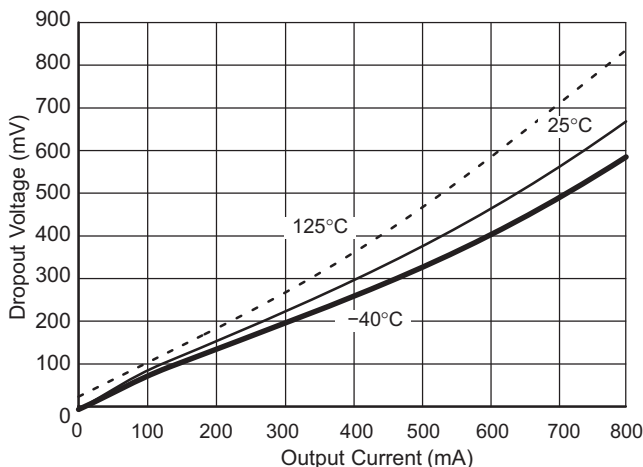

Figure 8. Dropout Voltage vs. Output Current

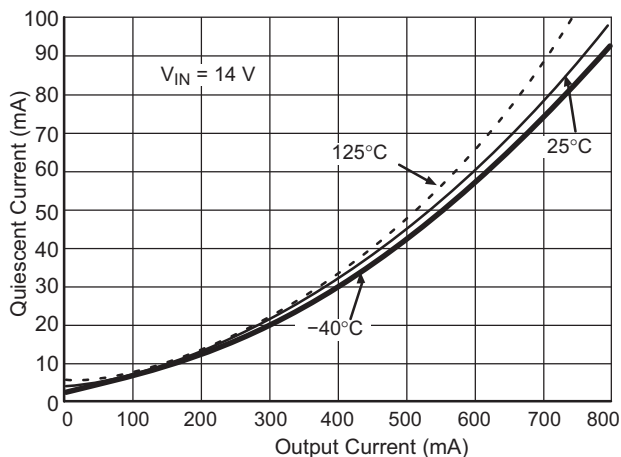

Figure 9. Quiescent Current vs. Output Current

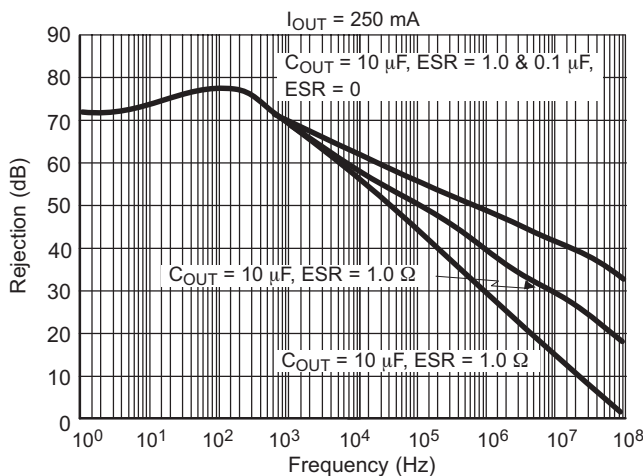

Figure 10. Ripple Rejection

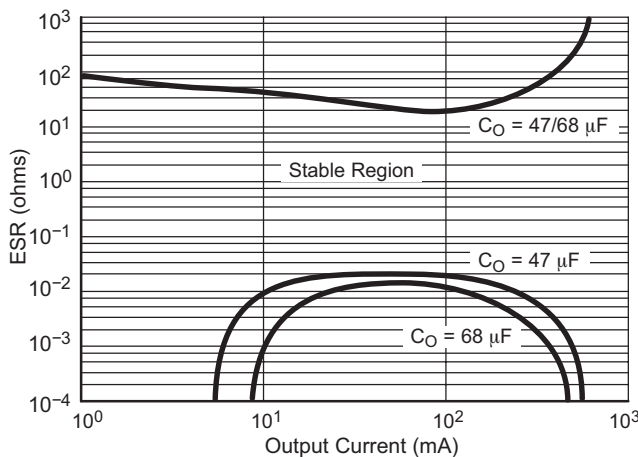

Figure 11. Output Capacitor ESR

CS8122

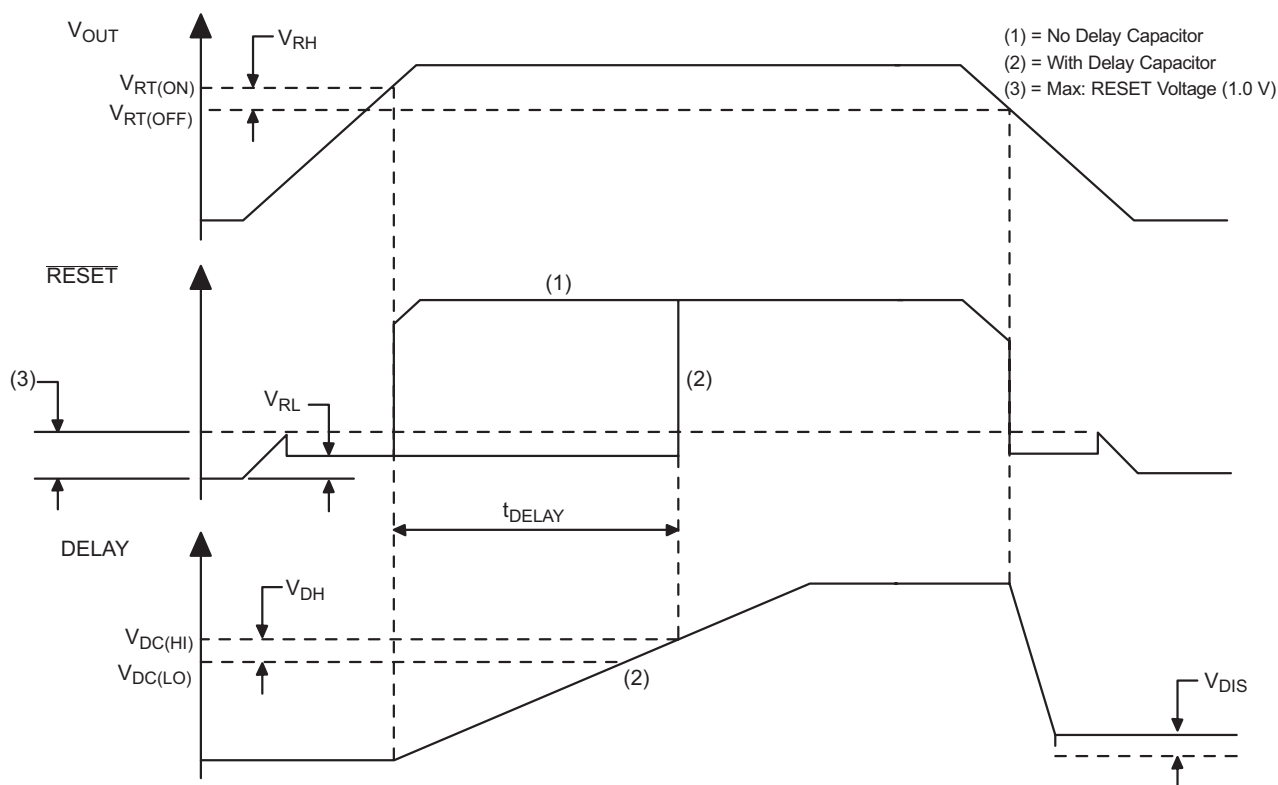

Figure 12. RESET Circuit Waveform

CIRCUIT DESCRIPTION

The CS8122 $\overline{\text{RESET}}$ function, has hysteresis on both the reset and delay comparators, a latching Delay capacitor discharge circuit, and operates down to 1.0 V.

The $\overline{\text{RESET}}$ circuit output is an open collector type with ON and OFF parameters as specified. The $\overline{\text{RESET}}$ output NPN transistor is controlled by the two circuits described (see Block Diagram on page 2).

Low Voltage Inhibit Circuit

The Low Voltage Inhibit Circuit monitors output voltage, and when output voltage is below the specified minimum, causes the $\overline{\text{RESET}}$ output transistor to be in the ON (saturation) state. When the output voltage is above the specified level, this circuit permits the $\overline{\text{RESET}}$ output transistor to go into the OFF state if allowed by the RESET Delay circuit.

Reset Delay Circuit

The Reset Delay Circuit provides a programmable (by external capacitor) delay on the $\overline{\text{RESET}}$ output lead. The Delay lead provides source current to the external delay capacitor only when the Low Voltage Inhibit circuit indicates that output voltage is above $V_{RT(ON)}$. Otherwise, the Delay lead sinks current to ground (used to discharge the

delay capacitor). The discharge current is latched ON when the output voltage is below $V_{RT(OFF)}$. The Delay capacitor is fully discharged anytime the output voltage falls out of regulation, even for a short period of time. This feature ensures that a controlled $\overline{\text{RESET}}$ pulse is generated following detection of an error condition. The circuit allows the $\overline{\text{RESET}}$ output transistor to go to the OFF (open) state only when the voltage on the Delay lead is higher than $V_{DC(HI)}$.

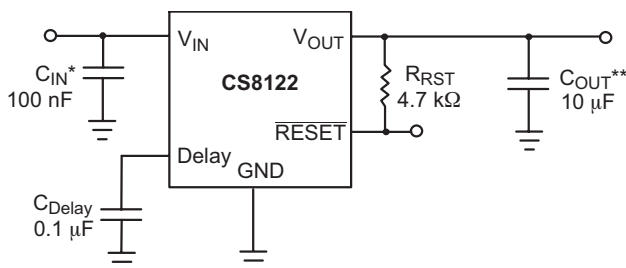

* C_{IN} is required if regulator is far from the power source filter.

** C_{OUT} is required for stability.

Figure 13. Test Circuit

APPLICATION NOTES

STABILITY CONSIDERATIONS

The output or compensation capacitor, C_{OUT} , helps determine three main characteristics of a linear regulator: start-up delay, load transient response and loop stability.

The capacitor value and type should be based on cost, availability, size and temperature constraints. A tantalum or aluminum electrolytic capacitor is best, since a film or ceramic capacitor with almost zero ESR can cause instability. The aluminum electrolytic capacitor is the least expensive solution, but, if the circuit operates at low temperatures (-25°C to -40°C), both the value and ESR of the capacitor will vary considerably. The capacitor manufacturers data sheet usually provides this information.

The value for the output capacitor C_{OUT} shown in Figure 13 should work for most applications, however it is not necessarily the optimized solution.

To determine an acceptable value for C_{OUT} for a particular application, start with a tantalum capacitor of the recommended value and work towards a less expensive alternative part.

Step 1: Place the completed circuit with a tantalum capacitor of the recommended value in an environmental chamber at the lowest specified operating temperature and monitor the outputs with an oscilloscope. A decade box connected in series with the capacitor will simulate the higher ESR of an aluminum capacitor. Leave the decade box outside the chamber, the small resistance added by the longer leads is negligible.

Step 2: With the input voltage at its maximum value, increase the load current slowly from zero to full load while observing the output for any oscillations. If no oscillations are observed, the capacitor is large enough to ensure a stable design under steady state conditions.

Step 3: Increase the ESR of the capacitor from zero using the decade box and vary the load current until oscillations appear. Record the values of load current and ESR that cause the greatest oscillation. This represents the worst case load conditions for the regulator at low temperature.

Step 4: Maintain the worst case load conditions set in step 3 and vary the input voltage until the oscillations increase. This point represents the worst case input voltage conditions.

Step 5: If the capacitor is adequate, repeat steps 3 and 4 with the next smaller valued capacitor. A smaller capacitor will usually cost less and occupy less board space. If the output oscillates within the range of expected operating conditions, repeat steps 3 and 4 with the next larger standard capacitor value.

Step 6: Test the load transient response by switching in various loads at several frequencies to simulate its real working environment. Vary the ESR to reduce ringing.

Step 7: Raise the temperature to the highest specified operating temperature. Vary the load current as instructed in step 5 to test for any oscillations.

Once the minimum capacitor value with the maximum ESR is found, a safety factor should be added to allow for the tolerance of the capacitor and any variations in regulator performance. Most good quality aluminum electrolytic capacitors have a tolerance of $\pm 20\%$ so the minimum value found should be increased by at least 50% to allow for this tolerance plus the variation which will occur at low temperatures. The ESR of the capacitor should be less than 50% of the maximum allowable ESR found in step 3 above.

CALCULATING POWER DISSIPATION IN A SINGLE OUTPUT LINEAR REGULATOR

The maximum power dissipation for a single output regulator (Figure 14) is:

$$P_{D(\max)} = (V_{IN(\max)} - V_{OUT(\min)})I_{OUT(\max)} + V_{IN(\max)}I_Q \quad (1)$$

where:

$V_{IN(\max)}$ is the maximum input voltage,

$V_{OUT(\min)}$ is the minimum output voltage,

$I_{OUT(\max)}$ is the maximum output current for the application, and

I_Q is the quiescent current the regulator consumes at $I_{OUT(\max)}$.

Once the value of $P_{D(\max)}$ is known, the maximum permissible value of $R_{\theta JA}$ can be calculated:

$$R_{\theta JA} = \frac{150^{\circ}\text{C} - T_A}{P_D} \quad (2)$$

The value of $R_{\theta JA}$ can then be compared with those in the package section of the data sheet. Those packages with $R_{\theta JA}$'s less than the calculated value in equation 2 will keep the die temperature below 150°C .

In some cases, none of the packages will be sufficient to dissipate the heat generated by the IC, and an external heatsink will be required.

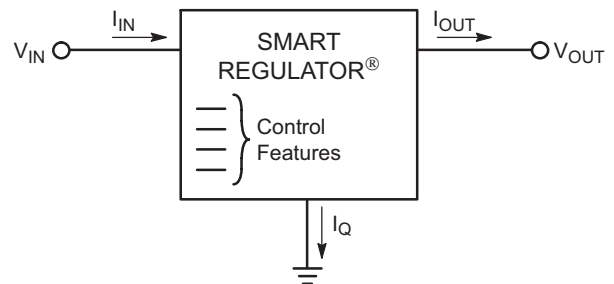

Figure 14. Single Output Regulator With Key Performance Parameters Labeled

CS8122

HEAT SINKS

A heat sink effectively increases the surface area of the package to improve the flow of heat away from the IC and into the surrounding air.

Each material in the heat flow path between the IC and the outside environment will have a thermal resistance. Like series electrical resistances, these resistances are summed to determine the value of $R_{\theta JA}$.

$$R_{\theta JA} = R_{\theta JC} + R_{\theta CS} + R_{\theta SA} \quad (3)$$

where:

$R_{\theta JC}$ = the junction-to-case thermal resistance,

$R_{\theta CS}$ = the case-to-heatsink thermal resistance, and

$R_{\theta SA}$ = the heatsink-to-ambient thermal resistance.

$R_{\theta JC}$ appears in the package section of the data sheet. Like $R_{\theta JA}$, it too is a function of package type. $R_{\theta CS}$ and $R_{\theta SA}$ are functions of the package type, heatsink and the interface between them. These values appear in heat sink data sheets of heat sink manufacturers.

ORDERING INFORMATION

| Device | Package | Shipping |
|--------------|-----------------------------------|-----------------|
| CS8122YT5 | TO-220 STRAIGHT | 50 Units / Rail |
| CS8122YT5G | TO-220 STRAIGHT (Pb-Free) | |
| CS8122YTVA5 | TO-220 VERTICAL | |
| CS8122YTVA5G | TO-220 VERTICAL (Pb-Free) | |
| CS8122YTHA5 | TO-220 HORIZONTAL | |
| CS8122YTHA5G | TO-220 HORIZONTAL (Pb-Free) | |

CS8122

PACKAGE DIMENSIONS

TO-220
CASE 314D-04
ISSUE F

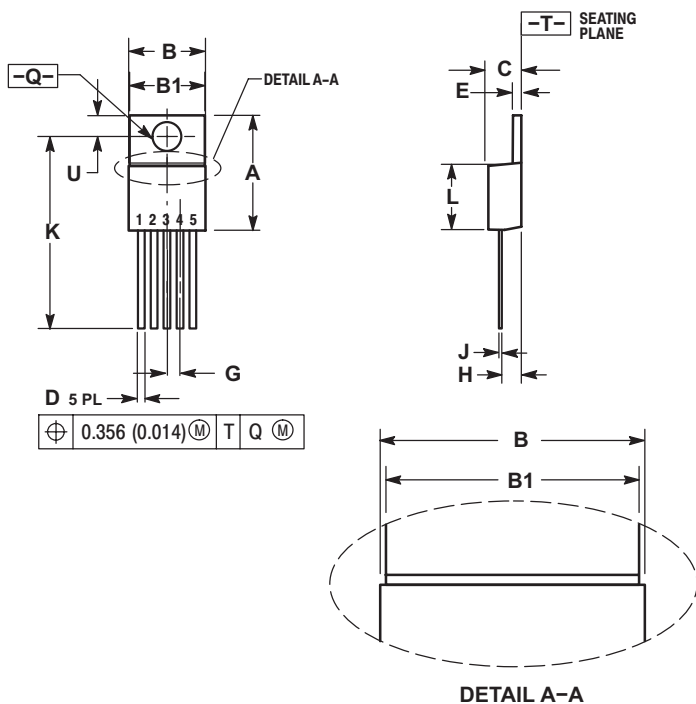

- NOTES:
1. DIMENSIONING AND TOLERANCING PER ANSI Y14.5M, 1982.
 2. CONTROLLING DIMENSION: INCH.
 3. DIMENSION D DOES NOT INCLUDE INTERCONNECT BAR (DAMBAR) PROTRUSION. DIMENSION D INCLUDING PROTRUSION SHALL NOT EXCEED 10.92 (0.043) MAXIMUM.

| DIM | INCHES | | MILLIMETERS | |
|-----|-----------|-------|-------------|--------|
| | MIN | MAX | MIN | MAX |
| A | 0.572 | 0.613 | 14.529 | 15.570 |
| B | 0.390 | 0.415 | 9.906 | 10.541 |
| B1 | 0.375 | 0.415 | 9.525 | 10.541 |
| C | 0.170 | 0.180 | 4.318 | 4.572 |
| D | 0.025 | 0.038 | 0.635 | 0.965 |
| E | 0.048 | 0.055 | 1.219 | 1.397 |
| G | 0.067 BSC | | 1.702 BSC | |
| H | 0.087 | 0.112 | 2.210 | 2.845 |
| J | 0.015 | 0.025 | 0.381 | 0.635 |
| K | 0.977 | 1.045 | 24.810 | 26.543 |
| L | 0.320 | 0.365 | 8.128 | 9.271 |
| Q | 0.140 | 0.153 | 3.556 | 3.886 |
| U | 0.105 | 0.117 | 2.667 | 2.972 |

TO-220
TVA SUFFIX
CASE 314K-01
ISSUE O

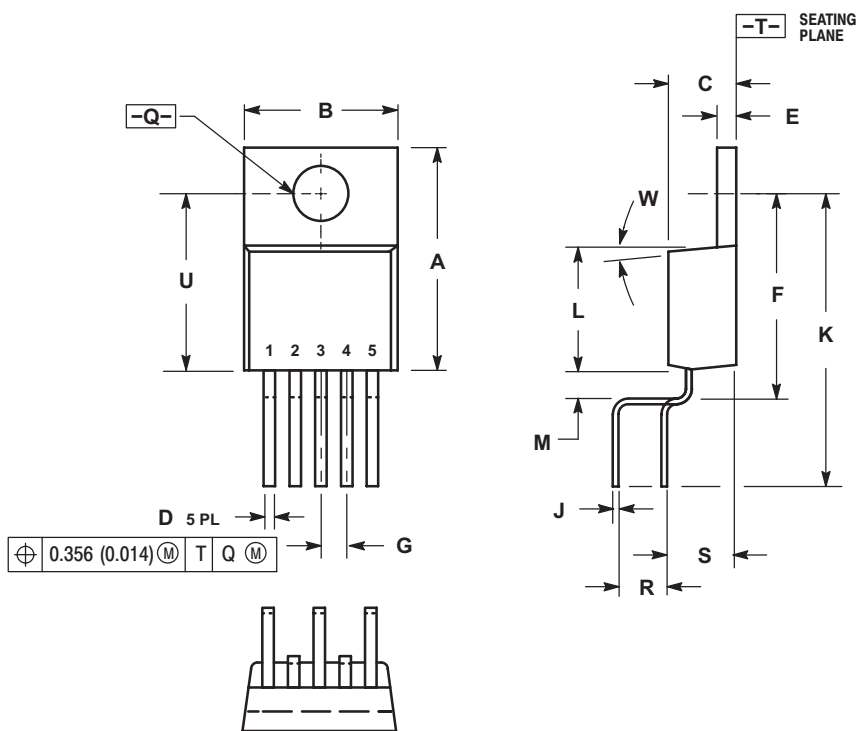

- NOTES:
1. DIMENSIONING AND TOLERANCING PER ANSI Y14.5M, 1982.
 2. CONTROLLING DIMENSION: INCH.
 3. DIMENSION D DOES NOT INCLUDE INTERCONNECT BAR (DAMBAR) PROTRUSION. DIMENSION D INCLUDING PROTRUSION SHALL NOT EXCEED 10.92 (0.043) MAXIMUM.

| DIM | INCHES | | MILLIMETERS | |
|-----|-----------|-------|-------------|-------|
| | MIN | MAX | MIN | MAX |
| A | 0.560 | 0.590 | 14.22 | 14.99 |
| B | 0.385 | 0.415 | 9.78 | 10.54 |
| C | 0.160 | 0.190 | 4.06 | 4.83 |
| D | 0.027 | 0.037 | 0.69 | 0.94 |
| E | 0.045 | 0.055 | 1.14 | 1.40 |
| F | 0.530 | 0.545 | 13.46 | 13.84 |
| G | 0.067 BSC | | 1.70 BSC | |
| J | 0.014 | 0.022 | 0.36 | 0.56 |
| K | 0.785 | 0.800 | 19.94 | 20.32 |
| L | 0.321 | 0.337 | 8.15 | 8.56 |
| M | 0.063 | 0.078 | 1.60 | 1.98 |
| Q | 0.146 | 0.156 | 3.71 | 3.96 |
| R | 0.271 | 0.321 | 6.88 | 8.15 |
| S | 0.146 | 0.196 | 3.71 | 4.98 |
| U | 0.460 | 0.475 | 11.68 | 12.07 |
| W | 5° | | 5° | |

CS8122

PACKAGE DIMENSIONS

TO-220 THA SUFFIX CASE 314A-03 ISSUE E

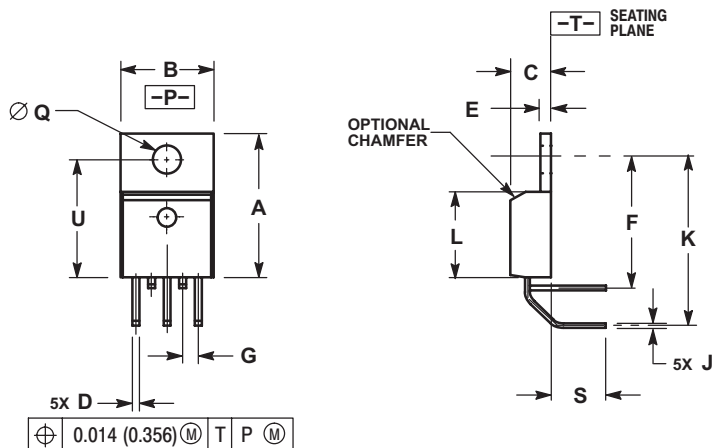

NOTES:

1. DIMENSIONING AND TOLERANCING PER ANSI Y14.5M, 1982.
2. CONTROLLING DIMENSION: INCH.
3. DIMENSION D DOES NOT INCLUDE INTERCONNECT BAR (DAMBAR) PROTRUSION. DIMENSION D INCLUDING PROTRUSION SHALL NOT EXCEED 0.043 (1.092) MAXIMUM.

| DIM | INCHES | | MILLIMETERS | |
|-----|-----------|-------|-------------|--------|
| | MIN | MAX | MIN | MAX |
| A | 0.572 | 0.613 | 14.529 | 15.570 |
| B | 0.390 | 0.415 | 9.906 | 10.541 |
| C | 0.170 | 0.180 | 4.318 | 4.572 |
| D | 0.025 | 0.038 | 0.635 | 0.965 |
| E | 0.048 | 0.055 | 1.219 | 1.397 |
| F | 0.570 | 0.585 | 14.478 | 14.859 |
| G | 0.067 BSC | | 1.702 BSC | |
| J | 0.015 | 0.025 | 0.381 | 0.635 |
| K | 0.730 | 0.745 | 18.542 | 18.923 |
| L | 0.320 | 0.365 | 8.128 | 9.271 |
| Q | 0.140 | 0.153 | 3.556 | 3.886 |
| S | 0.210 | 0.260 | 5.334 | 6.604 |
| U | 0.468 | 0.505 | 11.888 | 12.827 |

PACKAGE THERMAL DATA

| Parameter | | TO-220 FIVE LEAD | Unit |
|------------------|---------|---------------------|------|
| R _{θJC} | Typical | 2.1 | °C/W |
| R _{θJA} | Typical | 50 | °C/W |

SMART REGULATOR are registered trademarks of Semiconductor Components Industries, LLC (SCILLC).

ON Semiconductor and are registered trademarks of Semiconductor Components Industries, LLC (SCILLC). SCILLC reserves the right to make changes without further notice to any products herein. SCILLC makes no warranty, representation or guarantee regarding the suitability of its products for any particular purpose, nor does SCILLC assume any liability arising out of the application or use of any product or circuit, and specifically disclaims any and all liability, including without limitation special, consequential or incidental damages. "Typical" parameters which may be provided in SCILLC data sheets and/or specifications can and do vary in different applications and actual performance may vary over time. All operating parameters, including "Typicals" must be validated for each customer application by customer's technical experts. SCILLC does not convey any license under its patent rights nor the rights of others. SCILLC products are not designed, intended, or authorized for use as components in systems intended for surgical implant into the body, or other applications intended to support or sustain life, or for any other application in which the failure of the SCILLC product could create a situation where personal injury or death may occur. Should Buyer purchase or use SCILLC products for any such unintended or unauthorized application, Buyer shall indemnify and hold SCILLC and its officers, employees, subsidiaries, affiliates, and distributors harmless against all claims, costs, damages, and expenses, and reasonable attorney fees arising out of, directly or indirectly, any claim of personal injury or death associated with such unintended or unauthorized use, even if such claim alleges that SCILLC was negligent regarding the design or manufacture of the part. SCILLC is an Equal Opportunity/Affirmative Action Employer. This literature is subject to all applicable copyright laws and is not for resale in any manner.

PUBLICATION ORDERING INFORMATION

LITERATURE FULFILLMENT:
Literature Distribution Center for ON Semiconductor
P.O. Box 5163, Denver, Colorado 80217 USA
Phone: 303-675-2175 or 800-344-3860 Toll Free USA/Canada
Fax: 303-675-2176 or 800-344-3867 Toll Free USA/Canada
Email: orderlit@onsemi.com

N. American Technical Support: 800-282-9855 Toll Free
USA/Canada
Europe, Middle East and Africa Technical Support:
Phone: 421 33 790 2910
Japan Customer Focus Center
Phone: 81-3-5773-3850

ON Semiconductor Website: www.onsemi.com
Order Literature: <http://www.onsemi.com/orderlit>

For additional information, please contact your local Sales Representative