



Is Now Part of



**ON Semiconductor®**

To learn more about ON Semiconductor, please visit our website at  
[www.onsemi.com](http://www.onsemi.com)

Please note: As part of the Fairchild Semiconductor integration, some of the Fairchild orderable part numbers will need to change in order to meet ON Semiconductor's system requirements. Since the ON Semiconductor product management systems do not have the ability to manage part nomenclature that utilizes an underscore (\_), the underscore (\_) in the Fairchild part numbers will be changed to a dash (-). This document may contain device numbers with an underscore (\_). Please check the ON Semiconductor website to verify the updated device numbers. The most current and up-to-date ordering information can be found at [www.onsemi.com](http://www.onsemi.com). Please email any questions regarding the system integration to [Fairchild\\_questions@onsemi.com](mailto:Fairchild_questions@onsemi.com).

ON Semiconductor and the ON Semiconductor logo are trademarks of Semiconductor Components Industries, LLC dba ON Semiconductor or its subsidiaries in the United States and/or other countries. ON Semiconductor owns the rights to a number of patents, trademarks, copyrights, trade secrets, and other intellectual property. A listing of ON Semiconductor's product/patent coverage may be accessed at [www.onsemi.com/site/pdf/Patent-Marking.pdf](http://www.onsemi.com/site/pdf/Patent-Marking.pdf). ON Semiconductor reserves the right to make changes without further notice to any products herein. ON Semiconductor makes no warranty, representation or guarantee regarding the suitability of its products for any particular purpose, nor does ON Semiconductor assume any liability arising out of the application or use of any product or circuit, and specifically disclaims any and all liability, including without limitation special, consequential or incidental damages. Buyer is responsible for its products and applications using ON Semiconductor products, including compliance with all laws, regulations and safety requirements or standards, regardless of any support or applications information provided by ON Semiconductor. "Typical" parameters which may be provided in ON Semiconductor data sheets and/or specifications can and do vary in different applications and actual performance may vary over time. All operating parameters, including "Typicals" must be validated for each customer application by customer's technical experts. ON Semiconductor does not convey any license under its patent rights nor the rights of others. ON Semiconductor products are not designed, intended, or authorized for use as a critical component in life support systems or any FDA Class 3 medical devices or medical devices with a same or similar classification in a foreign jurisdiction or any devices intended for implantation in the human body. Should Buyer purchase or use ON Semiconductor products for any such unintended or unauthorized application, Buyer shall indemnify and hold ON Semiconductor and its officers, employees, subsidiaries, affiliates, and distributors harmless against all claims, costs, damages, and expenses, and reasonable attorney fees arising out of, directly or indirectly, any claim of personal injury or death associated with such unintended or unauthorized use, even if such claim alleges that ON Semiconductor was negligent regarding the design or manufacture of the part. ON Semiconductor is an Equal Opportunity/Affirmative Action Employer. This literature is subject to all applicable copyright laws and is not for resale in any manner.

# 74LCX11

## Low Voltage Triple 3-Input AND Gate with 5V Tolerant Inputs

### Features

- 5V tolerant inputs
- 2.3V–3.6V  $V_{CC}$  specifications provided
- 6.0ns  $t_{PD}$  max. ( $V_{CC} = 3.3V$ ), 10 $\mu$ A  $I_{CC}$  max.
- Power down high impedance inputs and outputs
- $\pm 24mA$  output drive ( $V_{CC} = 3.0V$ )
- Implements proprietary noise/EMI reduction circuitry
- Latch-up performance exceeds JEDEC 78 conditions
- ESD performance:
  - Human body model > 2000V
  - Machine model > 200V
- Leadless DQFN package

### General Description

The LCX11 is a triple 3-input AND gate with buffered outputs. LCX devices are designed for low voltage (2.5V or 3.3V) operation with the added capability of interfacing to a 5V signal environment.

The 74LCX11 is fabricated with advanced CMOS technology to achieve high speed operation while maintaining CMOS low power dissipation.

### Ordering Information

Order Number	Package Number	Package Description
74LCX11M	M14A	14-Lead Small Outline Integrated Circuit (SOIC), JEDEC MS-012, 0.150" Narrow
74LCX11SJ	M14D	14-Lead Small Outline Package (SOP), EIAJ TYPE II, 5.3mm Wide
74LCX11BQX <sup>(1)</sup>	MLP14A	14-Terminal Depopulated Quad Very-Thin Flat Pack No Leads (DQFN), JEDEC MO-241, 2.5 x 3.0mm
74LCX11MTC	MTC14	14-Lead Thin Shrink Small Outline Package (TSSOP), JEDEC MO-153, 4.4mm Wide

#### Note:

1. DQFN package available in Tape and Reel only.

Device also available in Tape and Reel. Specify by appending suffix letter "X" to the ordering number.

 All packages are lead free per JEDEC: J-STD-020B standard.

### Connection Diagrams

Pin Assignments for SOIC, SOP, and TSSOP

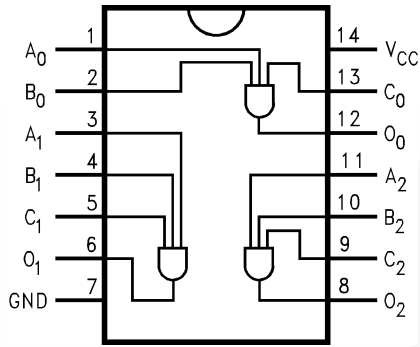

(Top View)

Pad Assignments for DQFN

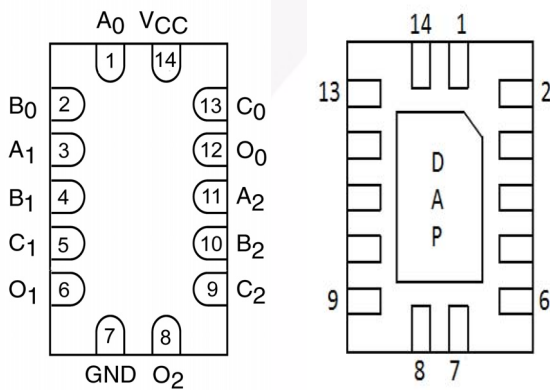

(Top Through View)

(Bottom View)

### Logic Symbol

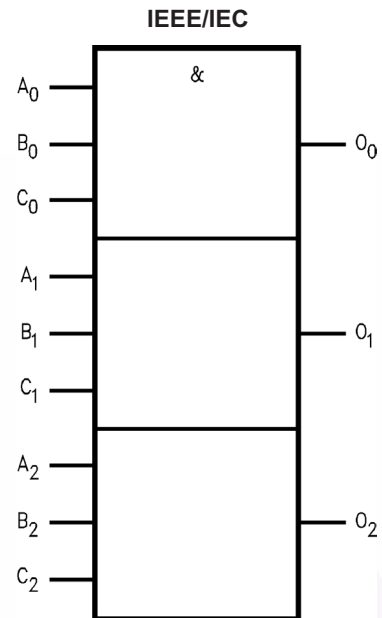

### Logic Diagram

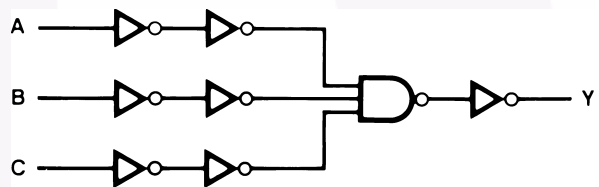

### Pin Description

Pin Names	Description
A <sub>n</sub> , B <sub>n</sub> , C <sub>n</sub>	Inputs
O <sub>n</sub>	Outputs
DAP	No Connect

Note: DAP (Die Attach Pad)

## Absolute Maximum Ratings

Stresses exceeding the absolute maximum ratings may damage the device. The device may not function or be operable above the recommended operating conditions and stressing the parts to these levels is not recommended. In addition, extended exposure to stresses above the recommended operating conditions may affect device reliability. The absolute maximum ratings are stress ratings only.

Symbol	Parameter	Rating
$V_{CC}$	Supply Voltage	-0.5V to +7.0V
$V_I$	DC Input Voltage	-0.5V to +7.0V
$V_O$	DC Output Voltage, Output in HIGH or LOW State <sup>(2)</sup>	-0.5V to $V_{CC} + 0.5V$
$I_{IK}$	DC Input Diode Current, $V_I < GND$	-50mA
$I_{OK}$	DC Output Diode Current $V_O < GND$	-50mA
	$V_O > V_{CC}$	+50mA
$I_O$	DC Output Source/Sink Current	$\pm 50mA$
$I_{CC}$	DC Supply Current per Supply Pin	$\pm 100mA$
$I_{GND}$	DC Ground Current per Ground Pin	$\pm 100mA$
$T_{STG}$	Storage Temperature	-65°C to +150°C

**Note:**

2.  $I_O$  Absolute Maximum Rating must be observed.

## Recommended Operating Conditions<sup>(3)</sup>

The Recommended Operating Conditions table defines the conditions for actual device operation. Recommended operating conditions are specified to ensure optimal performance to the datasheet specifications. Fairchild does not recommend exceeding them or designing to absolute maximum ratings.

Symbol	Parameter	Min.	Max.	Units
$V_{CC}$	Supply Voltage Operating	2.0	3.6	V
	Data Retention	1.5	3.6	
$V_I$	Input Voltage	0	5.5	V
$V_O$	Output Voltage, HIGH or LOW State	0	$V_{CC}$	V
$I_{OH} / I_{OL}$	Output Current $V_{CC} = 3.0V-3.6V$		$\pm 24$	mA
	$V_{CC} = 2.7V-3.0V$		$\pm 12$	
	$V_{CC} = 2.3V-2.7V$		$\pm 8$	
$T_A$	Free-Air Operating Temperature	-40	85	°C
$\Delta t / \Delta V$	Input Edge Rate, $V_{IN} = 0.8V-2.0V$ , $V_{CC} = 3.0V$	0	10	ns/V

**Note:**

3. Unused inputs must be held HIGH or LOW. They may not float.

## DC Electrical Characteristics

Symbol	Parameter	V <sub>CC</sub> (V)	Conditions	T <sub>A</sub> = -40°C to +85°C		Units
				Min.	Max.	
V <sub>IH</sub>	HIGH Level Input Voltage	2.3–2.7		1.7		V
		2.7–3.6		2.0		
V <sub>IL</sub>	LOW Level Input Voltage	2.3–2.7			0.7	V
		2.7–3.6			0.8	
V <sub>OH</sub>	HIGH Level Output Voltage	2.3–3.6	I <sub>OH</sub> = -100μA	V <sub>CC</sub> - 0.2		V
		2.3	I <sub>OH</sub> = -8mA	1.8		
		2.7	I <sub>OH</sub> = -12mA	2.2		
		3.0	I <sub>OH</sub> = -18mA	2.4		
			I <sub>OH</sub> = -24mA	2.2		
V <sub>OL</sub>	LOW Level Output Voltage	2.3–3.6	I <sub>OL</sub> = 100μA		0.2	V
		2.3	I <sub>OL</sub> = 8mA		0.6	
		2.7	I <sub>OL</sub> = 12mA		0.4	
		3.0	I <sub>OL</sub> = 16mA		0.4	
			I <sub>OL</sub> = 24mA		0.55	
I <sub>I</sub>	Input Leakage Current	2.3–3.6	0 ≤ V <sub>I</sub> ≤ 5.5V		±5.0	μA
I <sub>OFF</sub>	Power-Off Leakage Current	0	V <sub>I</sub> or V <sub>O</sub> = 5.5V		10	μA
I <sub>CC</sub>	Quiescent Supply Current	2.3–3.6	V <sub>I</sub> = V <sub>CC</sub> or GND		10	μA
			3.6V ≤ V <sub>I</sub> ≤ 5.5V		±10	
ΔI <sub>CC</sub>	Increase in I <sub>CC</sub> per Input	2.3–3.6	V <sub>IH</sub> = V <sub>CC</sub> - 0.6V		500	μA

## AC Electrical Characteristics

Symbol	Parameter	T <sub>A</sub> = -40°C to +85°C, R <sub>L</sub> = 500Ω						Units
		V <sub>CC</sub> = 3.3V ± 0.3V, C <sub>L</sub> = 50pF		V <sub>CC</sub> = 2.7V, C <sub>L</sub> = 50pF		V <sub>CC</sub> = 2.5V ± 0.2V, C <sub>L</sub> = 30pF		
		Min.	Max.	Min.	Max.	Min.	Max.	
t <sub>PHL</sub> , t <sub>PLH</sub>	Propagation Delay	1.5	6.0	1.5	7.0	1.5	7.2	ns
t <sub>OSSL</sub> , t <sub>OSLH</sub>	Output to Output Skew <sup>(4)</sup>		1.0					ns

## Note:

4. Skew is defined as the absolute value of the difference between the actual propagation delay for any two separate outputs of the same device. The specification applies to any outputs switching in the same direction, either HIGH-to-LOW (t<sub>OSSL</sub>) or LOW-to-HIGH (t<sub>OSLH</sub>).

**Dynamic Switching Characteristics**

Symbol	Parameter	V <sub>CC</sub> (V)	Conditions	T <sub>A</sub> = 25°C	
				Typical	Unit
V <sub>OLP</sub>	Quiet Output Dynamic Peak V <sub>OL</sub>	3.3	C <sub>L</sub> = 50pF, V <sub>IH</sub> = 3.3V, V <sub>IL</sub> = 0V	0.8	V
		2.5	C <sub>L</sub> = 30pF, V <sub>IH</sub> = 2.5V, V <sub>IL</sub> = 0V	0.6	
V <sub>OLV</sub>	Quiet Output Dynamic Valley V <sub>OL</sub>	3.3	C <sub>L</sub> = 50pF, V <sub>IH</sub> = 3.3V, V <sub>IL</sub> = 0V	-0.8	V
		2.5	C <sub>L</sub> = 30pF, V <sub>IH</sub> = 2.5V, V <sub>IL</sub> = 0V	-0.6	

**Capacitance**

Symbol	Parameter	Conditions	Typical	Units
C <sub>IN</sub>	Input Capacitance	V <sub>CC</sub> = Open, V <sub>I</sub> = 0V or V <sub>CC</sub>	7	pF
C <sub>OUT</sub>	Output Capacitance	V <sub>CC</sub> = 3.3V, V <sub>I</sub> = 0V or V <sub>CC</sub>	8	pF
C <sub>PD</sub>	Power Dissipation Capacitance	V <sub>CC</sub> = 3.3V, V <sub>I</sub> = 0V or V <sub>CC</sub> , f = 10MHz	25	pF

### AC Loading and Waveforms (Generic for LCX Family)

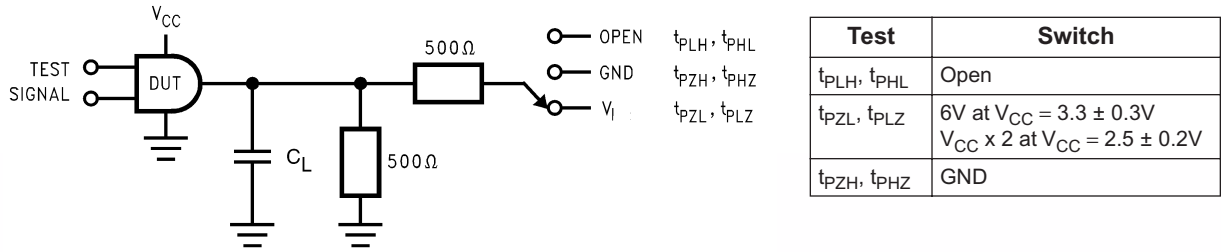
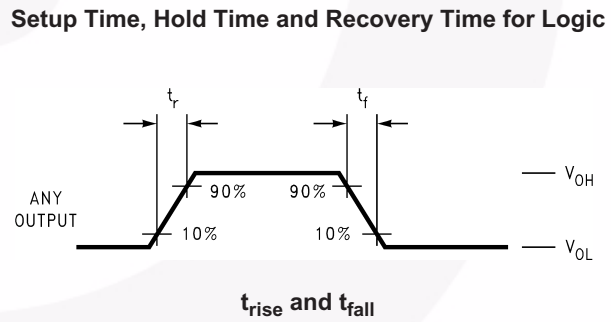
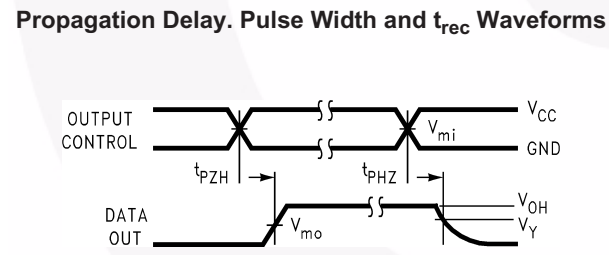
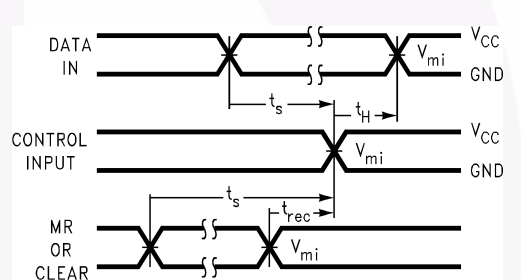
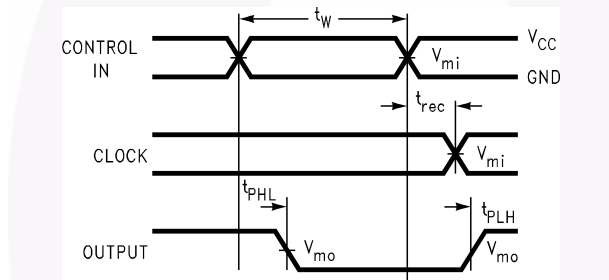
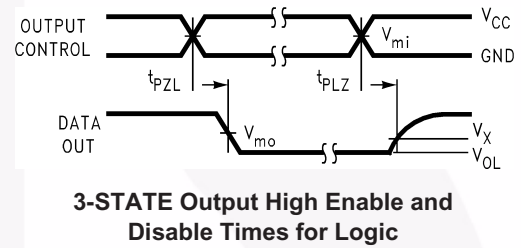

Figure 1. AC Test Circuit ( $C_L$  includes probe and jig capacitance)



Symbol	$V_{CC}$		
	$3.3V \pm 0.3V$	2.7V	$2.5V \pm 0.2V$
$V_{mi}$	1.5V	1.5V	$V_{CC}/2$
$V_{mo}$	1.5V	1.5V	$V_{CC}/2$
$V_x$	$V_{OL} + 0.3V$	$V_{OL} + 0.3V$	$V_{OL} + 0.15V$
$V_y$	$V_{OH} - 0.3V$	$V_{OH} - 0.3V$	$V_{OH} - 0.15V$

Figure 2. Waveforms (Input Characteristics;  $f = 1MHz, t_r = t_f = 3ns$ )

**Schematic Diagram** (Generic for LCX Family)





## Tape and Reel Specification

### Tape Format for DQFN

Package Designator	Tape Section	Number of Cavities	Cavity Status	Cover Tape Status
BQX	Leader (Start End)	125 (Typ.)	Empty	Sealed
	Carrier	3000	Filled	Sealed
	Trailer (Hub End)	75 (Typ.)	Empty	Sealed

### Tape Dimensions inches (millimeters)



PKG. SIZE	DIM.Ao	DIM.Bo	DIM.Ko
3.5 X 4.5	3.8 ± 0.1	4.8 ± 0.1	0.9 ± 0.1
3.0 X 3.0	3.3 ± 0.1	3.3 ± 0.1	0.9 ± 0.1
2.5 X 4.5	2.8 ± 0.1	4.8 ± 0.1	0.9 ± 0.1
2.5 X 3.5	2.8 ± 0.1	3.8 ± 0.1	0.9 ± 0.1
2.5 X 3.0	2.8 ± 0.1	3.3 ± 0.1	0.9 ± 0.1
2.5 X 2.5	2.8 ± 0.1	2.8 ± 0.1	0.9 ± 0.1

DIMENSIONS ARE IN MILLIMETERS

NOTES: unless otherwise specified

1. Cumulative pitch for feeding holes and cavities (chip pockets) not to exceed 0.008[0.20] over 10 pitch span.
2. Smallest allowable bending radius.
3. Thru hole inside cavity is centered within cavity.
4. Tolerance is  $\pm 0.002[0.05]$  for these dimensions on all 12mm tapes.
5. Ao and Bo measured on a plane 0.120[0.30] above the bottom of the pocket.
6. Ko measured from a plane on the inside bottom of the pocket to the top surface of the carrier.
7. Pocket position relative to sprocket hole measured as true position of pocket. Not pocket hole.
8. Controlling dimension is millimeter. Dimension in inches rounded.

### Reel Dimensions inches (millimeters)



Tape Size	A	B	C	D	N	W1	W2
12mm	13.0 (330.0)	0.059 (1.50)	0.512 (13.00)	0.795 (20.20)	2.165 (55.00)	0.488 (12.4)	0.724 (18.4)



**NOTES:**

- A. CONFORMS TO JEDEC REGISTRATION MO-153, VARIATION AB, REF NOTE 6
- B. DIMENSIONS ARE IN MILLIMETERS.
- C. DIMENSIONS ARE EXCLUSIVE OF BURRS, MOLD FLASH, AND TIE BAR EXTRUSIONS
- D. DIMENSIONING AND TOLERANCES PER ANSI Y14.5M, 2009.
- E. LANDPATTERN STANDARD: SOP65P640X110-14M.
- F. DRAWING FILE NAME: MKT-MTC14rev7.



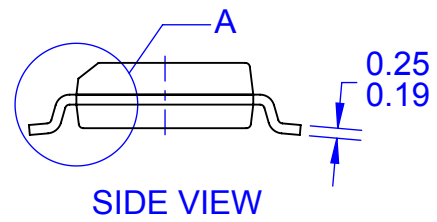
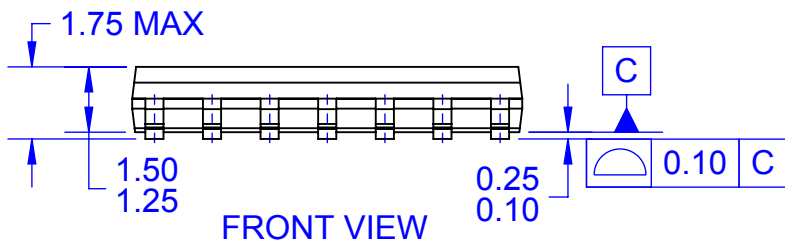
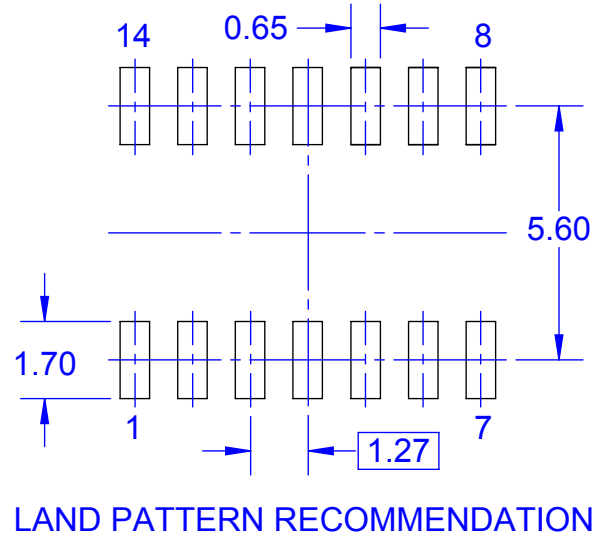

NOTES:

- A. CONFORMS TO JEDEC MS-012, VARIATION AB, ISSUE C
- B. ALL DIMENSIONS ARE IN MILLIMETERS
- C. DIMENSIONS DO NOT INCLUDE MOLD FLASH OR BURRS
- D. LAND PATTERN STANDARD: SOIC127P600X145-14M
- E. CONFORMS TO ASME Y14.5M, 2009
- D. DRAWING FILENAME: MKT-M14Arev14





**NOTES:**

- A. CONFORMS TO JEDEC REGISTRATION MO-241, VARIATION AA
- B. DIMENSIONS ARE IN MILLIMETERS.
- C. DIMENSIONS AND TOLERANCES PER ASME Y14.5M, 2009.
- D. LAND PATTERN RECOMMENDATION IS EXISTING INDUSTRY LAND PATTERN.
- E. DRAWING FILENAME: MKT-MLP14Arev2.



ON Semiconductor and  are trademarks of Semiconductor Components Industries, LLC dba ON Semiconductor or its subsidiaries in the United States and/or other countries. ON Semiconductor owns the rights to a number of patents, trademarks, copyrights, trade secrets, and other intellectual property. A listing of ON Semiconductor's product/patent coverage may be accessed at [www.onsemi.com/site/pdf/Patent-Marking.pdf](http://www.onsemi.com/site/pdf/Patent-Marking.pdf). ON Semiconductor reserves the right to make changes without further notice to any products herein. ON Semiconductor makes no warranty, representation or guarantee regarding the suitability of its products for any particular purpose, nor does ON Semiconductor assume any liability arising out of the application or use of any product or circuit, and specifically disclaims any and all liability, including without limitation special, consequential or incidental damages. Buyer is responsible for its products and applications using ON Semiconductor products, including compliance with all laws, regulations and safety requirements or standards, regardless of any support or applications information provided by ON Semiconductor. "Typical" parameters which may be provided in ON Semiconductor data sheets and/or specifications can and do vary in different applications and actual performance may vary over time. All operating parameters, including "Typicals" must be validated for each customer application by customer's technical experts. ON Semiconductor does not convey any license under its patent rights nor the rights of others. ON Semiconductor products are not designed, intended, or authorized for use as a critical component in life support systems or any FDA Class 3 medical devices or medical devices with a same or similar classification in a foreign jurisdiction or any devices intended for implantation in the human body. Should Buyer purchase or use ON Semiconductor products for any such unintended or unauthorized application, Buyer shall indemnify and hold ON Semiconductor and its officers, employees, subsidiaries, affiliates, and distributors harmless against all claims, costs, damages, and expenses, and reasonable attorney fees arising out of, directly or indirectly, any claim of personal injury or death associated with such unintended or unauthorized use, even if such claim alleges that ON Semiconductor was negligent regarding the design or manufacture of the part. ON Semiconductor is an Equal Opportunity/Affirmative Action Employer. This literature is subject to all applicable copyright laws and is not for resale in any manner.

## PUBLICATION ORDERING INFORMATION

### LITERATURE FULFILLMENT:

Literature Distribution Center for ON Semiconductor  
19521 E. 32nd Pkwy, Aurora, Colorado 80011 USA  
**Phone:** 303-675-2175 or 800-344-3860 Toll Free USA/Canada  
**Fax:** 303-675-2176 or 800-344-3867 Toll Free USA/Canada  
**Email:** [orderlit@onsemi.com](mailto:orderlit@onsemi.com)

**N. American Technical Support:** 800-282-9855 Toll Free  
USA/Canada  
**Europe, Middle East and Africa Technical Support:**  
Phone: 421 33 790 2910  
**Japan Customer Focus Center**  
Phone: 81-3-5817-1050

**ON Semiconductor Website:** [www.onsemi.com](http://www.onsemi.com)  
**Order Literature:** <http://www.onsemi.com/orderlit>  
For additional information, please contact your local  
Sales Representative