



Is Now Part of



**ON Semiconductor®**

To learn more about ON Semiconductor, please visit our website at  
[www.onsemi.com](http://www.onsemi.com)

Please note: As part of the Fairchild Semiconductor integration, some of the Fairchild orderable part numbers will need to change in order to meet ON Semiconductor's system requirements. Since the ON Semiconductor product management systems do not have the ability to manage part nomenclature that utilizes an underscore (\_), the underscore (\_) in the Fairchild part numbers will be changed to a dash (-). This document may contain device numbers with an underscore (\_). Please check the ON Semiconductor website to verify the updated device numbers. The most current and up-to-date ordering information can be found at [www.onsemi.com](http://www.onsemi.com). Please email any questions regarding the system integration to [Fairchild\\_questions@onsemi.com](mailto:Fairchild_questions@onsemi.com).

ON Semiconductor and the ON Semiconductor logo are trademarks of Semiconductor Components Industries, LLC dba ON Semiconductor or its subsidiaries in the United States and/or other countries. ON Semiconductor owns the rights to a number of patents, trademarks, copyrights, trade secrets, and other intellectual property. A listing of ON Semiconductor's product/patent coverage may be accessed at [www.onsemi.com/site/pdf/Patent-Marking.pdf](http://www.onsemi.com/site/pdf/Patent-Marking.pdf). ON Semiconductor reserves the right to make changes without further notice to any products herein. ON Semiconductor makes no warranty, representation or guarantee regarding the suitability of its products for any particular purpose, nor does ON Semiconductor assume any liability arising out of the application or use of any product or circuit, and specifically disclaims any and all liability, including without limitation special, consequential or incidental damages. Buyer is responsible for its products and applications using ON Semiconductor products, including compliance with all laws, regulations and safety requirements or standards, regardless of any support or applications information provided by ON Semiconductor. "Typical" parameters which may be provided in ON Semiconductor data sheets and/or specifications can and do vary in different applications and actual performance may vary over time. All operating parameters, including "Typicals" must be validated for each customer application by customer's technical experts. ON Semiconductor does not convey any license under its patent rights nor the rights of others. ON Semiconductor products are not designed, intended, or authorized for use as a critical component in life support systems or any FDA Class 3 medical devices or medical devices with a same or similar classification in a foreign jurisdiction or any devices intended for implantation in the human body. Should Buyer purchase or use ON Semiconductor products for any such unintended or unauthorized application, Buyer shall indemnify and hold ON Semiconductor and its officers, employees, subsidiaries, affiliates, and distributors harmless against all claims, costs, damages, and expenses, and reasonable attorney fees arising out of, directly or indirectly, any claim of personal injury or death associated with such unintended or unauthorized use, even if such claim alleges that ON Semiconductor was negligent regarding the design or manufacture of the part. ON Semiconductor is an Equal Opportunity/Affirmative Action Employer. This literature is subject to all applicable copyright laws and is not for resale in any manner.

## 74VCX162244

### Low Voltage 16-Bit Buffer/Line Driver with 3.6V Tolerant Inputs and Outputs and 26Ω Series Resistor in Outputs

#### General Description

The VCX162244 contains sixteen non-inverting buffers with 3-STATE outputs to be employed as a memory and address driver, clock driver, or bus oriented transmitter/receiver. The device is nibble (4-bit) controlled. Each nibble has separate 3-STATE control inputs which can be shorted together for full 16-bit operation.

The 74VCX162244 is designed for low voltage (1.2V to 3.6V)  $V_{CC}$  applications with I/O capability up to 3.6V. The 74VCX162244 is also designed with 26Ω series resistors in the outputs. This design reduces line noise in applications such as memory address drivers, clock drivers, and bus transceivers/transmitters.

The 74VCX162244 is fabricated with an advanced CMOS technology to achieve high speed operation while maintaining low CMOS power dissipation.

#### Features

- 1.2V to 3.6V  $V_{CC}$  supply operation
- 3.6V tolerant inputs and outputs
- 26Ω series resistors in outputs
- $t_{PD}$   
3.3 ns max for 3.0V to 3.6V  $V_{CC}$
- Power-off high impedance inputs and outputs
- Supports live insertion and withdrawal
- Static Drive ( $I_{OH}/I_{OL}$ )  
±12 mA @ 3.0V  $V_{CC}$
- Uses proprietary noise/EMI reduction circuitry
- Latch-up performance exceeds 300 mA
- ESD performance:  
Human body model > 2000V  
Machine model > 200V
- Also packaged in plastic Fine-Pitch Ball Grid Array (FBGA)

**Note 1:** To ensure the high-impedance state during power up or power down,  $\overline{OE}$  should be tied to  $V_{CC}$  through a pull-up resistor; the minimum value of the resistor is determined by the current-sourcing capability of the driver.

#### Ordering Code:

Order Number	Package Number	Package Description
74VCX162244G (Note 2)(Note 3)	BGA54A	54-Ball Fine-Pitch Ball Grid Array (FBGA), JEDEC MO-205, 5.5mm Wide
74VCX162244MTD (Note 3)	MTD48	48-Lead Thin Shrink Small Outline Package (TSSOP), JEDEC MO-153, 6.1mm Wide

**Note 2:** Ordering Code "G" indicates Trays.

**Note 3:** Devices also available in Tape and Reel. Specify by appending suffix letter "X" to the ordering code.

#### Logic Symbol

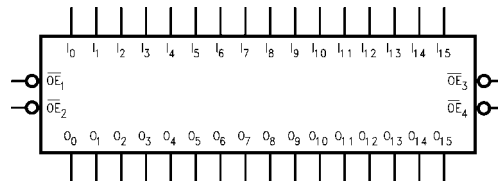

74VCX162244 Low Voltage 16-Bit Buffer/Line Driver with 3.6V Tolerant Inputs and Outputs and 26Ω Series Resistor in Outputs

### Connection Diagrams

Pin Assignment for TSSOP

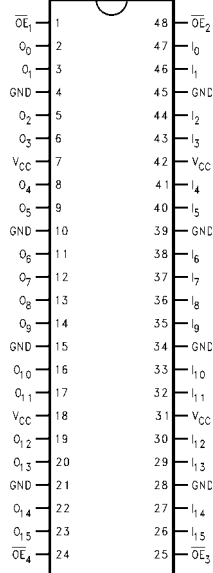

Pin Assignment for FBGA

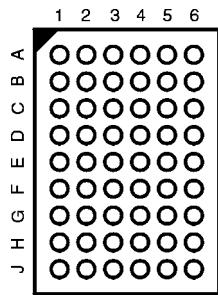

(Top Thru View)

### Pin Descriptions

Pin Names	Description
$\overline{OE}_n$	Output Enable Input (Active LOW)
$I_0-I_{15}$	Inputs
$O_0-O_{15}$	Outputs
NC	No Connect

### FBGA Pin Assignments

	1	2	3	4	5	6
<b>A</b>	$O_0$	NC	$\overline{OE}_1$	$\overline{OE}_2$	NC	$I_0$
<b>B</b>	$O_2$	$O_1$	NC	NC	$I_1$	$I_2$
<b>C</b>	$O_4$	$O_3$	$V_{CC}$	$V_{CC}$	$I_3$	$I_4$
<b>D</b>	$O_6$	$O_5$	GND	GND	$I_5$	$I_6$
<b>E</b>	$O_8$	$O_7$	GND	GND	$I_7$	$I_8$
<b>F</b>	$O_{10}$	$O_9$	GND	GND	$I_9$	$I_{10}$
<b>G</b>	$O_{12}$	$O_{11}$	$V_{CC}$	$V_{CC}$	$I_{11}$	$I_{12}$
<b>H</b>	$O_{14}$	$O_{13}$	NC	NC	$I_{13}$	$I_{14}$
<b>J</b>	$O_{15}$	NC	$\overline{OE}_4$	$\overline{OE}_3$	NC	$I_{15}$

### Truth Tables

Inputs		Outputs
$\overline{OE}_1$	$I_0-I_3$	$O_0-O_3$
L	L	L
L	H	H
H	X	Z

Inputs		Outputs
$\overline{OE}_2$	$I_4-I_7$	$O_4-O_7$
L	L	L
L	H	H
H	X	Z

Inputs		Outputs
$\overline{OE}_3$	$I_8-I_{11}$	$O_8-O_{11}$
L	L	L
L	H	H
H	X	Z

Inputs		Outputs
$\overline{OE}_4$	$I_{12}-I_{15}$	$O_{12}-O_{15}$
L	L	L
L	H	H
H	X	Z

H = HIGH Voltage Level  
 L = LOW Voltage Level  
 X = Immaterial (HIGH or LOW, inputs may not float)  
 Z = High Impedance

## Functional Description

The 74VCX162244 contains sixteen non-inverting buffers with 3-STATE outputs. The device is nibble (4 bits) controlled with each nibble functioning identically, but independent of each other. The control pins may be shorted together to obtain full 16-bit operation. The 3-STATE out-

puts are controlled by an Output Enable ( $\overline{OE}_n$ ) input. When  $\overline{OE}_n$  is LOW, the outputs are in the 2-state mode. When  $\overline{OE}_n$  is HIGH, the standard outputs are in the high impedance mode but this does not interfere with entering new data into the inputs.

## Logic Diagram

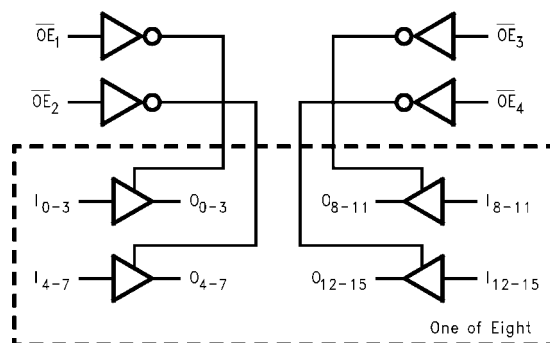

**Absolute Maximum Ratings** (Note 4)

Supply Voltage ( $V_{CC}$ )	-0.5V to +4.6V
DC Input Voltage ( $V_I$ )	-0.5V to +4.6V
Output Voltage ( $V_O$ )	
Outputs 3-STATE	-0.5V to +4.6V
Outputs Active (Note 5)	-0.5V to $V_{CC} + 0.5V$
DC Input Diode Current ( $I_{IK}$ ) $V_I < 0V$	-50 mA
DC Output Diode Current ( $I_{OK}$ )	
$V_O < 0V$	-50 mA
$V_O > V_{CC}$	+50 mA
DC Output Source/Sink Current	
( $I_{OH}/I_{OL}$ )	$\pm 50$ mA
DC $V_{CC}$ or GND Current per	
Supply Pin ( $I_{CC}$ or GND)	$\pm 100$ mA
Storage Temperature Range ( $T_{STG}$ )	-65°C to +150°C

**Recommended Operating Conditions** (Note 6)

Power Supply	
Operating	1.2V to 3.6V
Data Retention Only	1.2V to 3.6V
Input Voltage	-0.3V to +3.6V
Output Voltage ( $V_O$ )	
Output in Active States	0V to $V_{CC}$
Output in 3-State	0.0V to 3.6V
Output Current in $I_{OH}/I_{OL}$	
$V_{CC} = 3.0V$ to 3.6V	$\pm 12$ mA
$V_{CC} = 2.3V$ to 2.7V	$\pm 8$ mA
$V_{CC} = 1.65V$ to 2.3V	$\pm 3$ mA
$V_{CC} = 1.4V$ to 1.6V	$\pm 2$ mA
$V_{CC} = 1.2V$	$\pm 100$ $\mu$ A
Free Air Operating Temperature ( $T_A$ )	-40°C to +85°C
Minimum Input Edge Rate ( $\Delta t/\Delta V$ )	
$V_{IN} = 0.8V$ to 2.0V, $V_{CC} = 3.0V$	10 ns/V

**Note 4:** The Absolute Maximum Ratings are those values beyond which the safety of the device cannot be guaranteed. The device should not be operated at these limits. The parametric values defined in the Electrical Characteristics tables are not guaranteed at the Absolute Maximum Ratings. The "Recommended Operating Conditions" table will define the conditions for actual device operation.

**Note 5:**  $I_O$  Absolute Maximum Rating must be observed.

**Note 6:** Floating or unused inputs must be held HIGH or LOW.

**DC Electrical Characteristics (2.7V <  $V_{CC}$   $\leq$  3.6V)**

Symbol	Parameter	Conditions	$V_{CC}$ (V)	Min	Max	Units
$V_{IH}$	HIGH Level Input Voltage		2.7 - 3.6	2.0		V
			2.3 - 2.7	1.6		
			1.65 - 2.3	$0.65 \times V_{CC}$		
			1.4 - 1.6	$0.65 \times V_{CC}$		
			1.2	$0.65 \times V_{CC}$		
$V_{IL}$	LOW Level Input Voltage		2.7 - 3.6		0.8	V
			2.3 - 2.7		0.7	
			1.65 - 2.3		$0.35 \times V_{CC}$	
			1.4 - 1.6		$0.35 \times V_{CC}$	
			1.2		$0.5 \times V_{CC}$	
$V_{OH}$	HIGH Level Output Voltage	$I_{OH} = -100 \mu A$ $I_{OH} = -6$ mA $I_{OH} = -8$ mA $I_{OH} = -12$ mA	2.7 - 3.6	$V_{CC} - 0.2$		V
			2.7	2.2		
			3.0	2.4		
			3.0	2.2		
		$I_{OH} = -100 \mu A$ $I_{OH} = -4$ mA $I_{OH} = -6$ mA $I_{OH} = -8$ mA	2.7 - 3.6	$V_{CC} - 0.2$		
			2.3	2.0		
			2.3	1.8		
			2.3	1.7		
		$I_{OH} = -100 \mu A$ $I_{OH} = -3$ mA	1.65 - 2.3	$V_{CC} - 0.2$		
			1.65	1.25		
		$I_{OH} = -100 \mu A$ $I_{OH} = -1$ mA	1.4 - 1.6	$V_{CC} - 0.2$		
			1.4	1.05		
		$I_{OH} = -100 \mu A$	1.2	$V_{CC} - 0.1$		

DC Electrical Characteristics (2.7V < VCC ≤ 3.6V) (Continued)							
Symbol	Parameter	Conditions	V <sub>CC</sub> (V)	Min	Max	Units	
V <sub>OL</sub>	LOW Level Output Voltage	I <sub>OL</sub> = 100 μA	2.7 - 3.6		0.2	V	
		I <sub>OL</sub> = 6 mA	2.7		0.4		
		I <sub>OL</sub> = 8 mA	3.0		0.55		
		I <sub>OL</sub> = 12 mA	3.0		0.8		
		I <sub>OL</sub> = 100 μA	2.7 - 3.6		0.2		
		I <sub>OL</sub> = 6 mA	2.3		0.4		
		I <sub>OL</sub> = 8 mA	2.3		0.6		
		I <sub>OL</sub> = 100 μA	1.65 - 2.3		0.2		
		I <sub>OL</sub> = 3 mA	1.65		0.3		
I <sub>I</sub>	Input Leakage Current	0 ≤ V <sub>I</sub> ≤ 3.6V	1.2 - 3.6		±5.0	μA	
		I <sub>OZ</sub>	3-STATE Output Leakage	0 ≤ V <sub>O</sub> ≤ 3.6V V <sub>I</sub> = V <sub>IH</sub> or V <sub>IL</sub>	1.2 - 3.6		±10
I <sub>OFF</sub>	Power-OFF Leakage Current	0 ≤ (V <sub>I</sub> , V <sub>O</sub> ) ≤ 3.6V	0		10	μA	
I <sub>CC</sub>	Quiescent Supply Current	V <sub>I</sub> = V <sub>CC</sub> or GND	1.2 - 3.6		20	μA	
		V <sub>CC</sub> ≤ (V <sub>I</sub> , V <sub>O</sub> ) ≤ 3.6V (Note 7)	1.2 - 3.6		±20	μA	
ΔI <sub>CC</sub>	Increase in I <sub>CC</sub> per Input	V <sub>IH</sub> = V <sub>CC</sub> - 0.6V	2.7 - 3.6		750	μA	
<b>Note 7:</b> Outputs disabled or 3-STATE only.							
AC Electrical Characteristics (Note 8)							
Symbol	Parameter	Conditions	V <sub>CC</sub> (V)	T <sub>A</sub> = -40°C to +85°C		Units	Figure Number
				Min	Max		
t <sub>PHL</sub> , t <sub>PLH</sub>	Propagation Delay	C <sub>L</sub> = 30 pF, R <sub>L</sub> = 500Ω	3.3 ± 0.3	0.8	3.3	ns	Figures 1, 2
			2.5 ± 0.2	1.0	3.8		
			1.8 ± 0.15	1.5	7.6		
t <sub>PZL</sub> , t <sub>PZH</sub>	Output Enable Time	C <sub>L</sub> = 15 pF, R <sub>L</sub> = 2kΩ	1.5 ± 0.1	1.0	15.2	ns	Figures 5, 6
			1.2	1.5	38		
			1.5 ± 0.1	1.0	19.6		
t <sub>PLZ</sub> , t <sub>PHZ</sub>	Output Disable Time	C <sub>L</sub> = 30 pF, R <sub>L</sub> = 500Ω	3.3 ± 0.3	0.8	3.6	ns	Figures 1, 3, 4
			2.5 ± 0.2	1.0	4.0		
			1.8 ± 0.15	1.5	7.2		
t <sub>PLZ</sub> , t <sub>PHZ</sub>	Output Disable Time	C <sub>L</sub> = 15 pF, R <sub>L</sub> = 2kΩ	1.5 ± 0.1	1.0	14.4	ns	Figures 5, 7, 8
			1.2	1.5	36		
			1.5 ± 0.1	1.0	14.4		
t <sub>OSSL</sub> , t <sub>OSLH</sub>	Output to Output Skew (Note 9)	C <sub>L</sub> = 30 pF, R <sub>L</sub> = 500Ω	3.3 ± 0.3		0.5	ns	
			2.5 ± 0.2		0.5		
			1.8 ± 0.15		0.75		
t <sub>OSSL</sub> , t <sub>OSLH</sub>	Output to Output Skew (Note 9)	C <sub>L</sub> = 15 pF, R <sub>L</sub> = 2kΩ	1.5 ± 0.1		1.5	ns	
			1.2		1.5		
<b>Note 8:</b> For C <sub>L</sub> = 50 pF, add approximately 300 ps to the AC maximum specification.							
<b>Note 9:</b> Skew is defined as the absolute value of the difference between the actual propagation delay for any two separate outputs of the same device. The specification applies to any outputs switching in the same direction, either HIGH-to-LOW (t <sub>OSSL</sub> ) or LOW-to-HIGH (t <sub>OSLH</sub> ).							

Dynamic Switching Characteristics					
Symbol	Parameter	Conditions	V <sub>CC</sub> (V)	T <sub>A</sub> = +25°C	Units
				Typical	
V <sub>OLP</sub>	Quiet Output Dynamic Peak V <sub>OL</sub>	C <sub>L</sub> = 30 pF, V <sub>IH</sub> = V <sub>CC</sub> , V <sub>IL</sub> = 0V	1.8	0.15	V
			2.5	0.25	
			3.3	0.35	
V <sub>OLV</sub>	Quiet Output Dynamic Valley V <sub>OL</sub>	C <sub>L</sub> = 30 pF, V <sub>IH</sub> = V <sub>CC</sub> , V <sub>IL</sub> = 0V	1.8	-0.15	V
			2.5	-0.25	
			3.3	-0.35	
V <sub>OHV</sub>	Quiet Output Dynamic Valley V <sub>OH</sub>	C <sub>L</sub> = 30 pF, V <sub>IH</sub> = V <sub>CC</sub> , V <sub>IL</sub> = 0V	1.8	1.55	V
			2.5	2.05	
			3.3	2.65	
Capacitance					
Symbol	Parameter	Conditions	T <sub>A</sub> = +25°C		Units
			Typical		
C <sub>IN</sub>	Input Capacitance	V <sub>CC</sub> = 1.8, 2.5V or 3.3V, V <sub>I</sub> = 0V or V <sub>CC</sub>	6		pF
C <sub>OUT</sub>	Output Capacitance	V <sub>I</sub> = 0V or V <sub>CC</sub> , V <sub>CC</sub> = 1.8V, 2.5V or 3.3V	7		pF
C <sub>PD</sub>	Power Dissipation Capacitance	V <sub>I</sub> = 0V or V <sub>CC</sub> , f = 10 MHz, V <sub>CC</sub> = 1.8V, 2.5V or 3.3V	20		pF

**AC Loading and Waveforms ( $V_{CC}$  3.3V ± 0.3V to 1.8V ± 0.15V)**

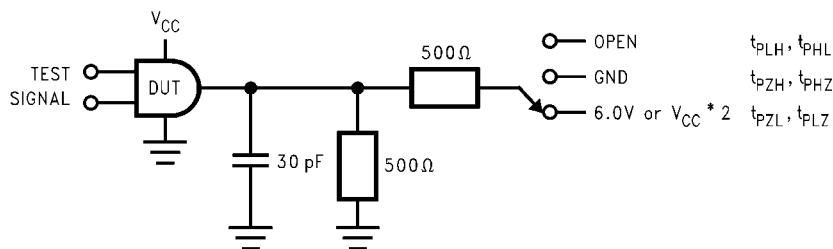

TEST	SWITCH
$t_{PLH}, t_{PHL}$	Open
$t_{PZL}, t_{PLZ}$	6V at $V_{CC} = 3.3 \pm 0.3V$ ; $V_{CC} \times 2$ at $V_{CC} = 2.5 \pm 0.2V; 1.8 \pm 0.15V$
$t_{PZH}, t_{PHZ}$	GND

**FIGURE 1. AC Test Circuit**

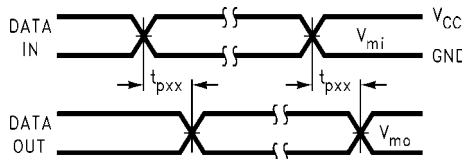

**FIGURE 2. Waveform for Inverting and Non-Inverting Functions**

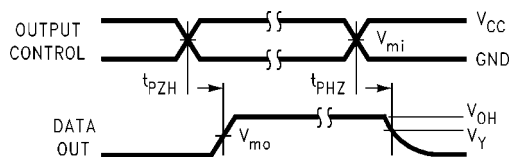

**FIGURE 3. 3-STATE Output High Enable and Disable Times for Low Voltage Logic**

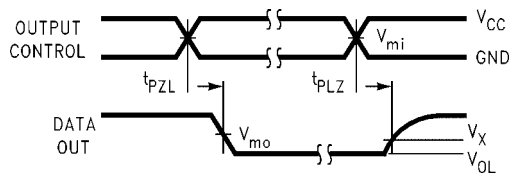
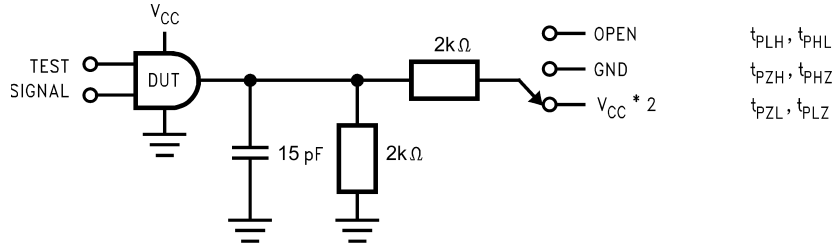

**FIGURE 4. 3-STATE Output Low Enable and Disable Times for Low Voltage Logic**

Symbol	$V_{CC}$		
	3.3V ± 0.3V	2.5V ± 0.2V	1.8V ± 0.15V
$V_{mi}$	1.5V	$V_{CC}/2$	$V_{CC}/2$
$V_{mo}$	1.5V	$V_{CC}/2$	$V_{CC}/2$
$V_X$	$V_{OL} + 0.3V$	$V_{OL} + 0.15V$	$V_{OL} + 0.15V$
$V_Y$	$V_{OH} - 0.3V$	$V_{OH} - 0.15V$	$V_{OH} - 0.15V$



**AC Loading and Waveforms ( $V_{CC} 1.5V \pm 0.1V$  to  $1.2V$ )**



TEST	SWITCH
$t_{PLH}, t_{PHL}$	Open
$t_{PZL}, t_{PLZ}$	$V_{CC} \times 2$ at $V_{CC} = 1.5V \pm 0.1V$
$t_{PZH}, t_{PHZ}$	GND

**FIGURE 5. AC Test Circuit**

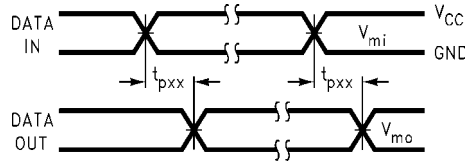

**FIGURE 6. Waveform for Inverting and Non-Inverting Functions**

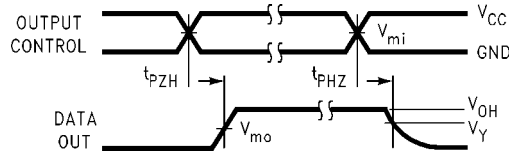

**FIGURE 7. 3-STATE Output High Enable and Disable Times for Low Voltage Logic**

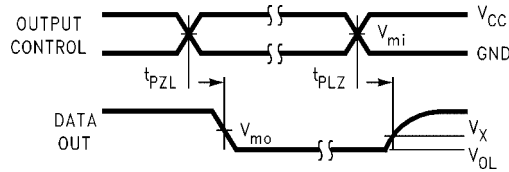

**FIGURE 8. 3-STATE Output Low Enable and Disable Times for Low Voltage Logic**

Symbol	$V_{CC}$
	$1.5V \pm 0.1V$
$V_{mi}$	$V_{CC}/2$
$V_{mo}$	$V_{CC}/2$
$V_X$	$V_{OL} + 0.1V$
$V_Y$	$V_{OL} - 0.1V$

**Physical Dimensions** inches (millimeters) unless otherwise noted

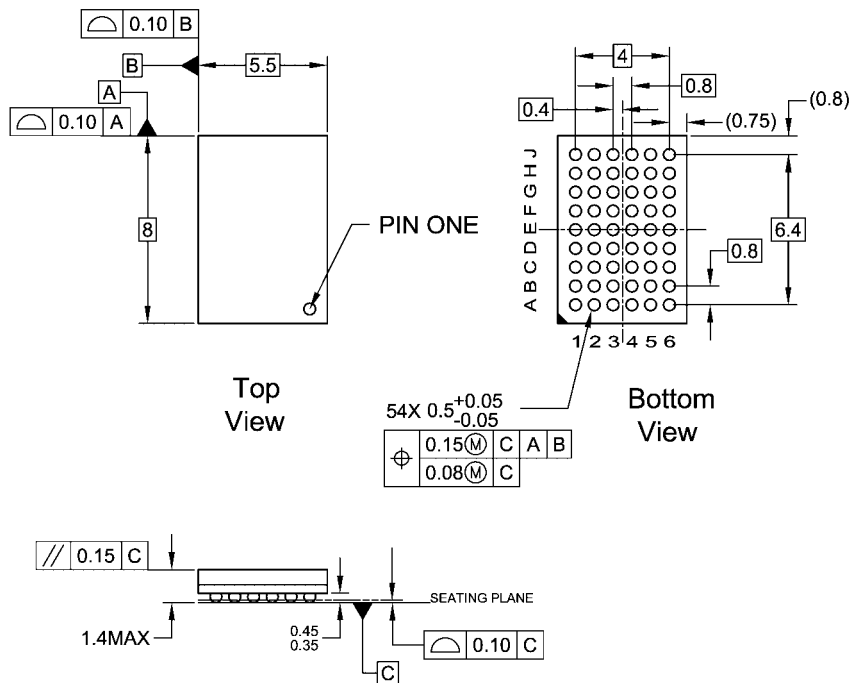

NOTES:

- A. THIS PACKAGE CONFORMS TO JEDEC M0-205
- B. ALL DIMENSIONS IN MILLIMETERS
- C. LAND PATTERN RECOMMENDATION: NSMD (Non Solder Mask Defined)  
.35MM DIA PADS WITH A SOLDERMASK OPENING OF .45MM CONCENTRIC TO PADS
- D. DRAWING CONFORMS TO ASME Y14.5M-1994

BGA54ArevD

**54-Ball Fine-Pitch Ball Grid Array (FBGA), JEDEC M0-205, 5.5mm Wide  
Package Number BGA54A**

**Physical Dimensions** inches (millimeters) unless otherwise noted (Continued)

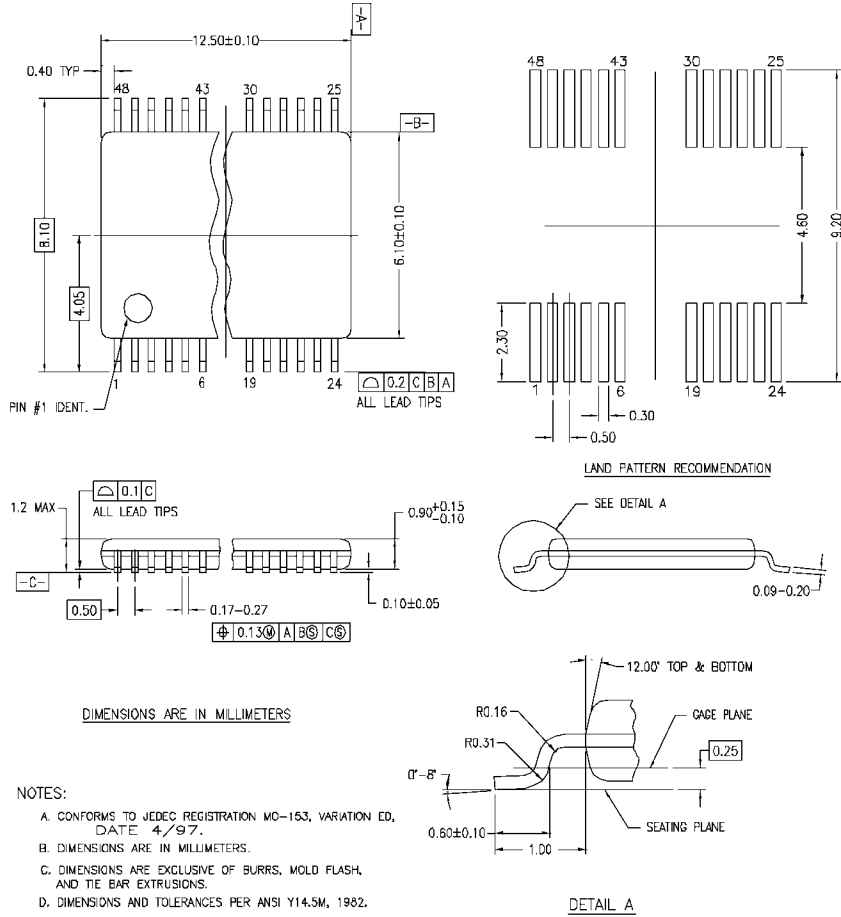

MTD48REV C

**48-Lead Thin Shrink Small Outline Package (TSSOP), JEDEC MO-153, 6.1mm Wide Package Number MTD48**

Fairchild does not assume any responsibility for use of any circuitry described, no circuit patent licenses are implied and Fairchild reserves the right at any time without notice to change said circuitry and specifications.

**LIFE SUPPORT POLICY**

FAIRCHILD'S PRODUCTS ARE NOT AUTHORIZED FOR USE AS CRITICAL COMPONENTS IN LIFE SUPPORT DEVICES OR SYSTEMS WITHOUT THE EXPRESS WRITTEN APPROVAL OF THE PRESIDENT OF FAIRCHILD SEMICONDUCTOR CORPORATION. As used herein:

- Life support devices or systems are devices or systems which, (a) are intended for surgical implant into the body, or (b) support or sustain life, and (c) whose failure to perform when properly used in accordance with instructions for use provided in the labeling, can be reasonably expected to result in a significant injury to the user.
- A critical component in any component of a life support device or system whose failure to perform can be reasonably expected to cause the failure of the life support device or system, or to affect its safety or effectiveness.

[www.fairchildsemi.com](http://www.fairchildsemi.com)

ON Semiconductor and  are trademarks of Semiconductor Components Industries, LLC dba ON Semiconductor or its subsidiaries in the United States and/or other countries. ON Semiconductor owns the rights to a number of patents, trademarks, copyrights, trade secrets, and other intellectual property. A listing of ON Semiconductor's product/patent coverage may be accessed at [www.onsemi.com/site/pdf/Patent-Marking.pdf](http://www.onsemi.com/site/pdf/Patent-Marking.pdf). ON Semiconductor reserves the right to make changes without further notice to any products herein. ON Semiconductor makes no warranty, representation or guarantee regarding the suitability of its products for any particular purpose, nor does ON Semiconductor assume any liability arising out of the application or use of any product or circuit, and specifically disclaims any and all liability, including without limitation special, consequential or incidental damages. Buyer is responsible for its products and applications using ON Semiconductor products, including compliance with all laws, regulations and safety requirements or standards, regardless of any support or applications information provided by ON Semiconductor. "Typical" parameters which may be provided in ON Semiconductor data sheets and/or specifications can and do vary in different applications and actual performance may vary over time. All operating parameters, including "Typicals" must be validated for each customer application by customer's technical experts. ON Semiconductor does not convey any license under its patent rights nor the rights of others. ON Semiconductor products are not designed, intended, or authorized for use as a critical component in life support systems or any FDA Class 3 medical devices or medical devices with a same or similar classification in a foreign jurisdiction or any devices intended for implantation in the human body. Should Buyer purchase or use ON Semiconductor products for any such unintended or unauthorized application, Buyer shall indemnify and hold ON Semiconductor and its officers, employees, subsidiaries, affiliates, and distributors harmless against all claims, costs, damages, and expenses, and reasonable attorney fees arising out of, directly or indirectly, any claim of personal injury or death associated with such unintended or unauthorized use, even if such claim alleges that ON Semiconductor was negligent regarding the design or manufacture of the part. ON Semiconductor is an Equal Opportunity/Affirmative Action Employer. This literature is subject to all applicable copyright laws and is not for resale in any manner.

## PUBLICATION ORDERING INFORMATION

### LITERATURE FULFILLMENT:

Literature Distribution Center for ON Semiconductor  
19521 E. 32nd Pkwy, Aurora, Colorado 80011 USA  
**Phone:** 303-675-2175 or 800-344-3860 Toll Free USA/Canada  
**Fax:** 303-675-2176 or 800-344-3867 Toll Free USA/Canada  
**Email:** [orderlit@onsemi.com](mailto:orderlit@onsemi.com)

**N. American Technical Support:** 800-282-9855 Toll Free  
USA/Canada  
**Europe, Middle East and Africa Technical Support:**  
Phone: 421 33 790 2910  
**Japan Customer Focus Center**  
Phone: 81-3-5817-1050

**ON Semiconductor Website:** [www.onsemi.com](http://www.onsemi.com)  
**Order Literature:** <http://www.onsemi.com/orderlit>  
For additional information, please contact your local  
Sales Representative