



Is Now Part of



ON Semiconductor®

To learn more about ON Semiconductor, please visit our website at
www.onsemi.com

Please note: As part of the Fairchild Semiconductor integration, some of the Fairchild orderable part numbers will need to change in order to meet ON Semiconductor's system requirements. Since the ON Semiconductor product management systems do not have the ability to manage part nomenclature that utilizes an underscore (_), the underscore (_) in the Fairchild part numbers will be changed to a dash (-). This document may contain device numbers with an underscore (_). Please check the ON Semiconductor website to verify the updated device numbers. The most current and up-to-date ordering information can be found at www.onsemi.com. Please email any questions regarding the system integration to Fairchild_questions@onsemi.com.

ON Semiconductor and the ON Semiconductor logo are trademarks of Semiconductor Components Industries, LLC dba ON Semiconductor or its subsidiaries in the United States and/or other countries. ON Semiconductor owns the rights to a number of patents, trademarks, copyrights, trade secrets, and other intellectual property. A listing of ON Semiconductor's product/patent coverage may be accessed at www.onsemi.com/site/pdf/Patent-Marking.pdf. ON Semiconductor reserves the right to make changes without further notice to any products herein. ON Semiconductor makes no warranty, representation or guarantee regarding the suitability of its products for any particular purpose, nor does ON Semiconductor assume any liability arising out of the application or use of any product or circuit, and specifically disclaims any and all liability, including without limitation special, consequential or incidental damages. Buyer is responsible for its products and applications using ON Semiconductor products, including compliance with all laws, regulations and safety requirements or standards, regardless of any support or applications information provided by ON Semiconductor. "Typical" parameters which may be provided in ON Semiconductor data sheets and/or specifications can and do vary in different applications and actual performance may vary over time. All operating parameters, including "Typicals" must be validated for each customer application by customer's technical experts. ON Semiconductor does not convey any license under its patent rights nor the rights of others. ON Semiconductor products are not designed, intended, or authorized for use as a critical component in life support systems or any FDA Class 3 medical devices or medical devices with a same or similar classification in a foreign jurisdiction or any devices intended for implantation in the human body. Should Buyer purchase or use ON Semiconductor products for any such unintended or unauthorized application, Buyer shall indemnify and hold ON Semiconductor and its officers, employees, subsidiaries, affiliates, and distributors harmless against all claims, costs, damages, and expenses, and reasonable attorney fees arising out of, directly or indirectly, any claim of personal injury or death associated with such unintended or unauthorized use, even if such claim alleges that ON Semiconductor was negligent regarding the design or manufacture of the part. ON Semiconductor is an Equal Opportunity/Affirmative Action Employer. This literature is subject to all applicable copyright laws and is not for resale in any manner.

FLD00060

I²C Digital Ambient Light and Proximity Sensor with Built-in IR LED

Features

- Built-in temperature compensation circuit
- Operating temperature: -30°C to 70°C
- Supply voltage range: 2.4V to 3.6V
- I²C serial port communication: Fast 400kHz
- Light sensing
 - Full dynamic range: 0.01 Lux to 64,000 Lux
 - High resolution range: 0.01 Lux to 320 Lux
 - 16-bit effective resolution
 - 50Hz/60Hz rejection
 - Immunity to IR and UV light
- Proximity sensing
 - Built-in LED driver, emitter and detector
 - Programmable LED drive current
 - 11-bit effective resolution
 - High ambient light rejection
- Size: 3.94mm(L) x 2.36mm(W) x 1.35mm(H)
- Halogen free

Applications

- Display backlight control for smart phones
- Laptops, desktops, monitors
- LCD TV

Description

The FLD00060 is a digital-output light and proximity sensor with a two-wire, I²C serial interface. It combines two photodiodes with signal processing on a single CMOS integrated circuit to provide a linear response over an effective 16-bit dynamic range from virtually 0 Lux to 64,000 Lux.

A built in proximity sensor provides a measurement of reflected IR light that results from the proximity of an object.

The FLD00060 includes an interrupt mode that signals to the controller readings exceeding a maximum threshold.

Block Diagram

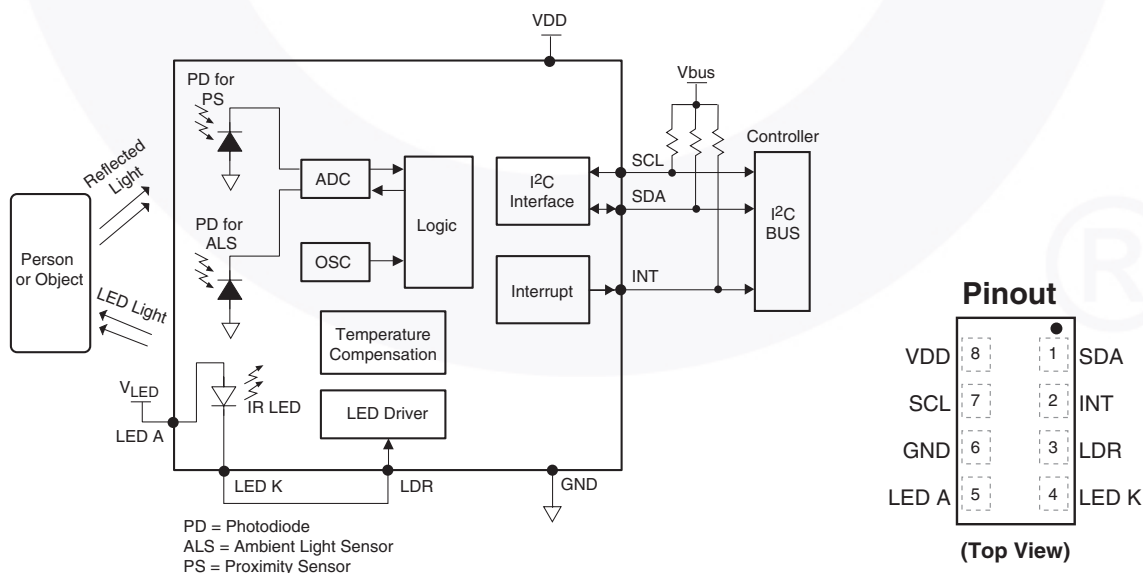

Pin Definitions

Pin	Symbol	I/O Type	Description
1	SDA	I/O	I ² C serial data. This pin is an open drain input / output.
2	INT	O	Level Interrupt Pin. This pin is an open drain output.
3	LDR	I	LED Driver for proximity emitter. This pin is an open drain input.
4	LED K	O	LED Cathode. Connect to LDR pin if internal LED driver circuit is in use.
5	LED A	I	A LED Anode. Connect to VDD or VBAT on PCB
6	GND		Ground
7	SCL	I	I ² C serial clock. This pin is an open drain input.
8	VDD		Power Supply Voltage

Absolute Maximum Ratings (T_A = 25°C)

Stresses exceeding the absolute maximum ratings may damage the device. The device may not function or be operable above the recommended operating conditions and stressing the parts to these levels is not recommended. In addition, extended exposure to stresses above the recommended operating conditions may affect device reliability. The absolute maximum ratings are stress ratings only.

Symbol	Parameter	Min.	Max.	Unit
V _{DD}	Supply Voltage	-0.5	3.8	V
V _O	Digital Output Voltage	-0.5	3.8	V
I _O	Digital Output Current	-1	+20	mA
T _{STG}	Storage Temperature	-40	+85	°C
T _{OPR}	Operating Temperature	-30	+70	°C

Recommended Operating Conditions

The Recommended Operating Conditions table defines the conditions for actual device operation. Recommended operating conditions are specified to ensure optimal performance to the data sheet specifications. Fairchild does not recommend exceeding them or designing to absolute maximum ratings.

Symbol	Parameter	Min.	Max.	Unit
V _{DD}	Supply Voltage	2.4	3.6	V
V _{LED}	LED Supply Voltage	2.5	4.35	V
V _{BUS}	Bus Supply Voltage	1.7	3.6	V
V _{IH}	I ² C Bus Input High (SCL/SDA)	1.2		V
V _{IL}	I ² C Bus Input Low (SCL/SDA)		0.6	V

Electrical/Optical Characteristics (T_A = 25°C and V_{DD} = 3.0V)

Symbol	Parameter	Test Condition	Min.	Typ.	Max.	Unit
I _{dd1}	Active Supply Current	Active Mode		200	300	μA
I _{dd2}	Standby Current	Standby / Sleep Mode			5	μA
T _{ini}	Initial Startup Time	Note 1	100			ms
T _{wakeup}	Wakeup Time from Standby	Note 1			10	ms
LIGHT SENSOR						
Data FS	Full Scale ADC Count				65535	Count
Data 0	Dark ADC Count	Ev = 0 lux (Ch0 and Ch1)	0		6	Count
Data 1	Ambient Light Output Ch0	Ev = 200 Lx, Gain = 1		95		Count
Data 2	Ambient Light Output Ch1			40		Count
Res 1	Ambient Light Resolution Range 1	(0.01 to 320 Lx)		0.005		Lx/Count
Res 2	Ambient Light Resolution Range 2	(2 to 64k Lx)		1		Lx/Count
PROXIMITY SENSOR						
Data_IR	Full Scale ADC Count				2047	Count
PSD	Detection Distance	100mA, 8 pulses, 18% Gray Card		50		mm
	Ambient Light Suppression	Direct sunlight			50k	Lux
IRPC	LED Pulse Count		1		255	Pulses
IRPF	LED Pulse Frequency	Increment of 10kHz	30k		100k	Hz
IRDC	LED Duty Cycle	Increment of 25%	25		100	%
IRDR11	LED Peak Current	LED Peak Current = 000		5		mA
IRDR12		LED Peak Current = 001		10		mA
IRDR13		LED Peak Current = 010		20		mA
IRDR14		LED Peak Current = 011		50		mA
IRDR15		LED Peak Current = 100/101/110/111		100		mA
tr/tf	Optical Rise / Fall Time		100			ns

Note:

1. Startup Sequence

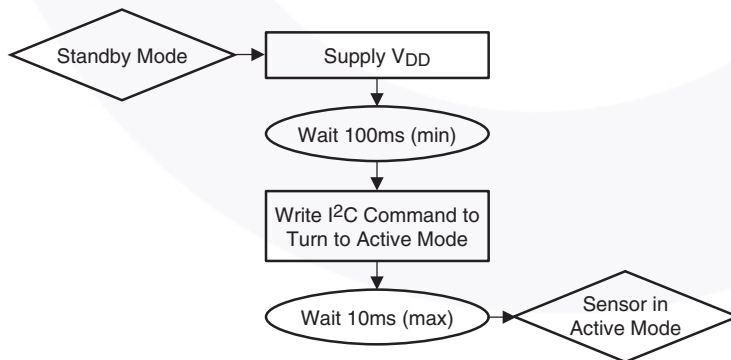

Typical Performance Characteristics

Fig. 1 Normalized Radiation Pattern for the Emitter (Simulation Data)

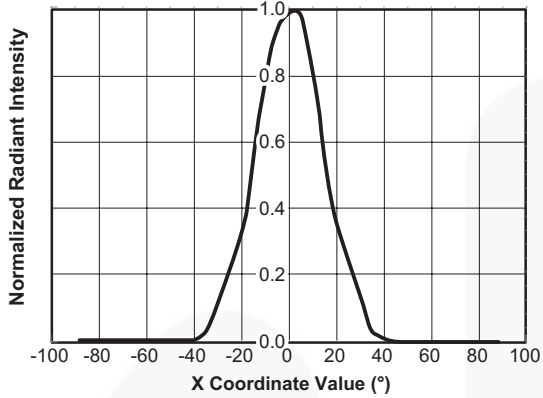

Fig. 2 Normalized Reception Pattern for the PS Detector (Simulation Data)

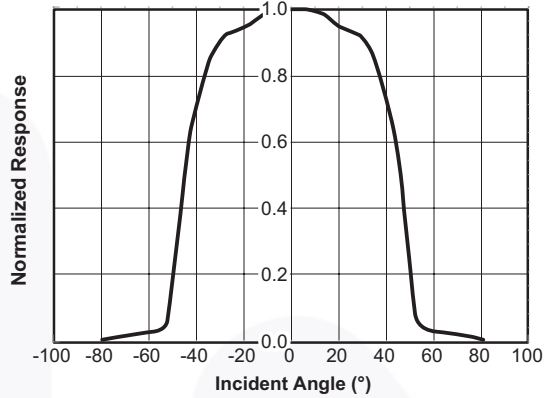

Fig. 3 Normalized Reception Pattern for the ALS Detector

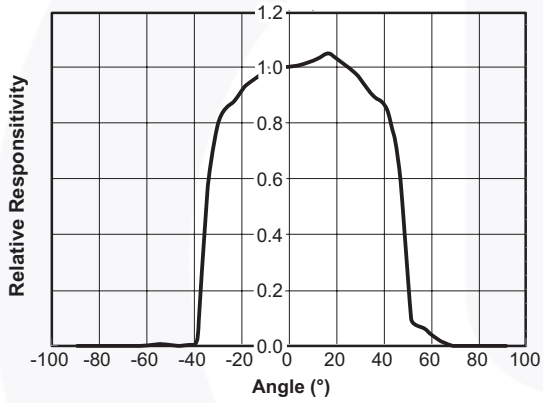
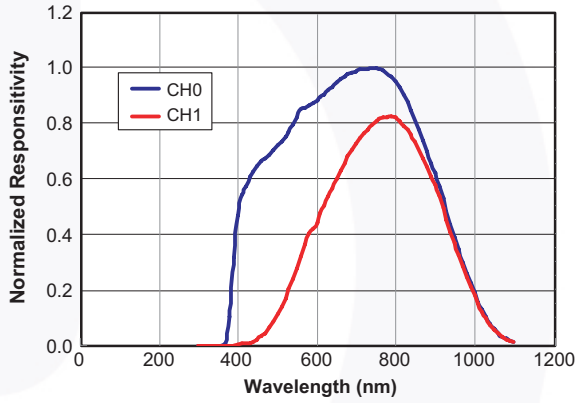

Fig. 4 Spectral Response



I²C Timing Specifications (V_{BUS} = 1.8V, T_{OPR} = 25°C)

Symbol	Parameter	Min.	Max.	Units
f _{SCL}	SCL Clock Frequency	1	400	kHz
t _{BUF}	Bus Free Time Between a STOP and START Condition	1.3		μs
t _{HD:STA}	Hold Time (Repeated) START Condition. After this period, the first clock pulse is generated	0.6		μs
t _{LOW}	LOW Period of the SCL Clock	1.3		μs
t _{HIGH}	HIGH Period of the SCL Clock	0.6		μs
t _{SU:STA}	Set-up Time for a Repeated START Condition	0.6		μs
t _{SU:STO}	Set-up Time for STOP Condition	0.6		μs
t _r	Rise Time of Both SDA and SCL Signals	30	300	ns
t _f	Fall Time of Both SDA and SCL Signals	30	300	ns
t _{HD:DAT}	Data Hold Time	0.3	0.9	μs
t _{SU:DAT}	Data Setup Time	100		ns
t _{SP}	Pulse Width of Spikes Which Must be Suppressed by the Input Filter	0	50	ns

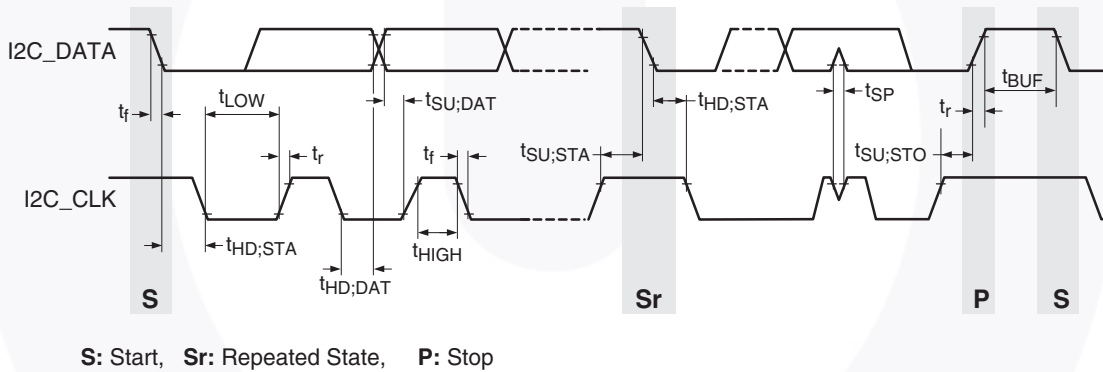

Figure 5. I²C Timing Diagram

I²C Interface – Read and Write Transactions

- Figure 6 through Figure 9 outline the sequences for data read and write.
- All addresses and data are MSB first.

Bit Definitions

A	Acknowledge (0 for an ACK)	N	Non-Acknowledge (1 for a NACK)
S	Start Condition	Sr	Repeated Start Condition
P	Stop Condition	R	Read (1 for Read)
W	Write (0 for Writing)	R	Read (1 for Read)
<input type="checkbox"/>	Slave-to-Master	<input type="checkbox"/>	Master-to-Slave

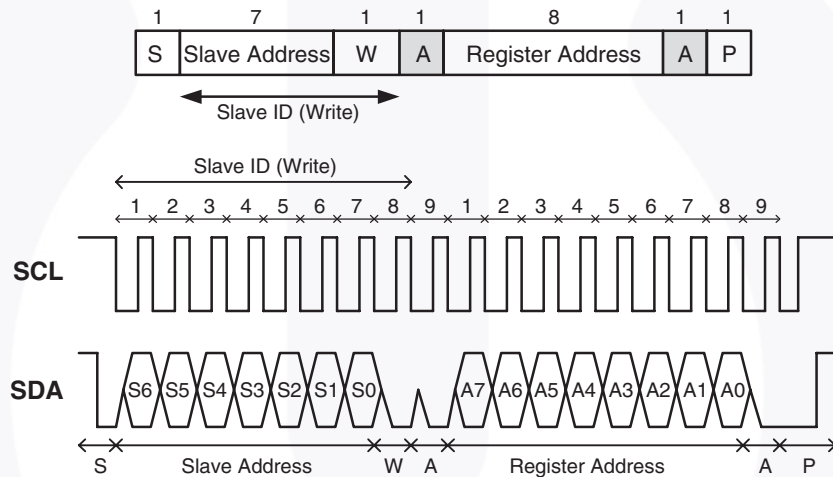

Figure 6. I²C Write Protocol (Type 1)

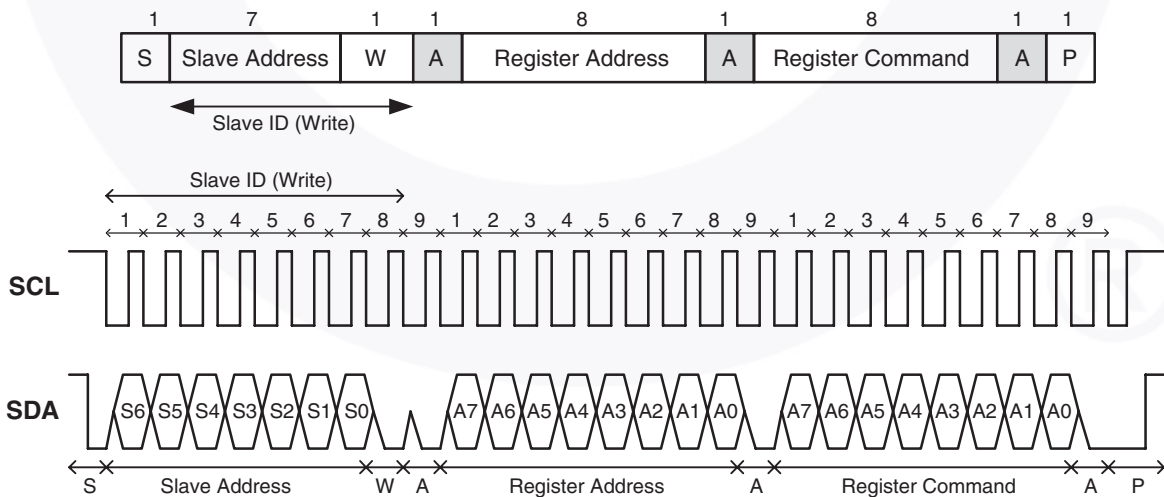

Figure 7. I²C Write Protocol (Type 2)

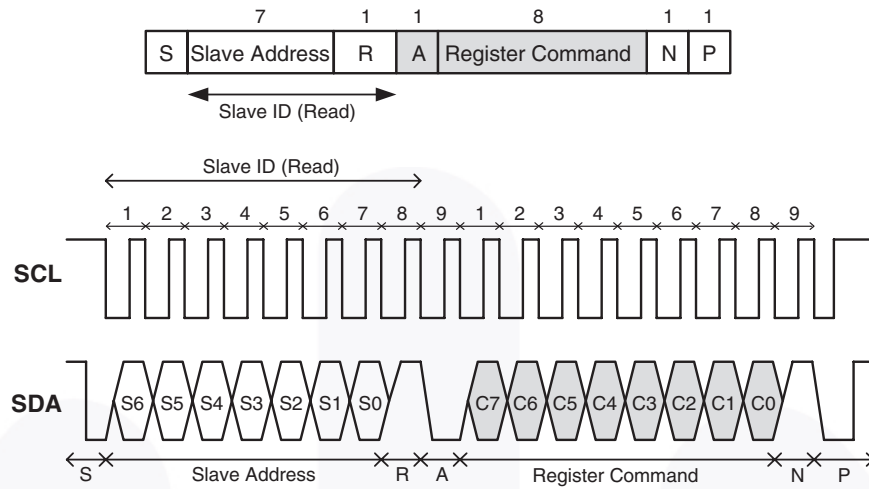

Figure 8. I²C Read Protocol

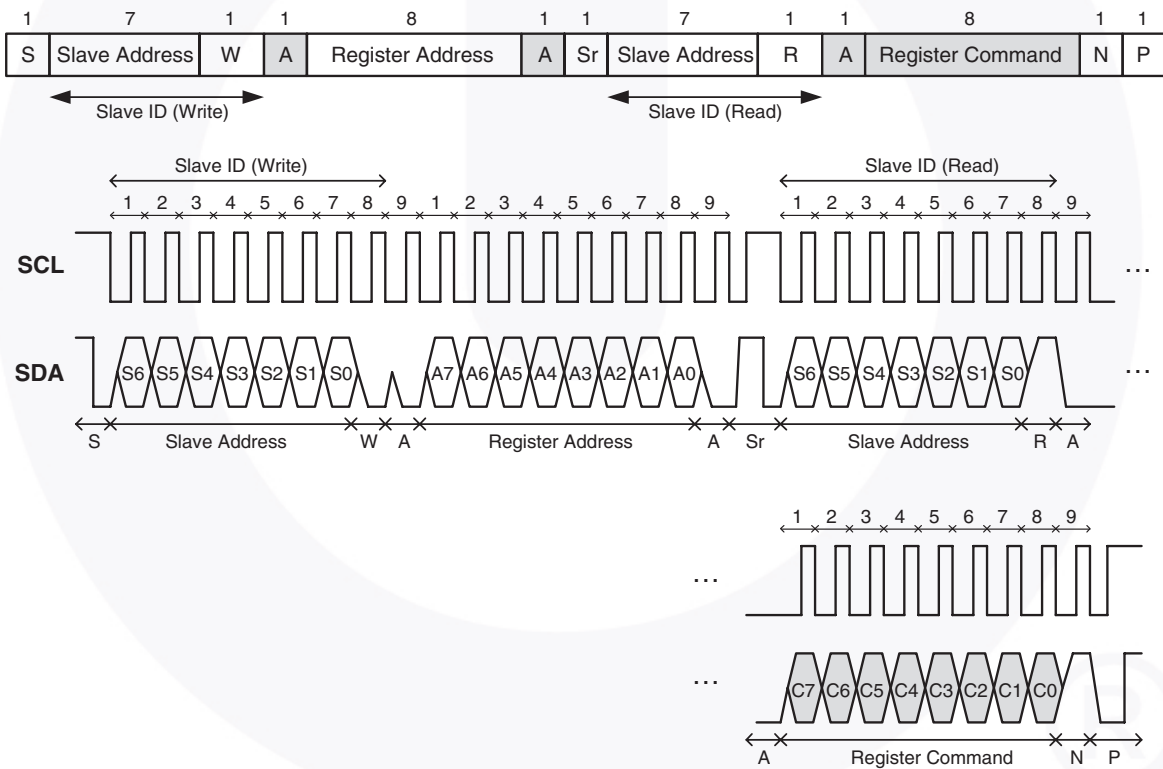

Figure 9. I²C Read (Combined Format) Protocol

I²C Slave Address

The 7 bits slave address for this sensor is 0x23H. A read/write bit should be appended to the slave address by the master device to properly communicate with the sensor.

I ² C Slave Address									
Command Type	(0x23H)							W/R	Value
	Bit 7	Bit 6	Bit 5	Bit 4	Bit 3	Bit 2	Bit 1	Bit 0	
Write	0	1	0	0	0	1	1	0	0x46H
Read	0	1	0	0	0	1	1	1	0x47H

Register Descriptions

Addr	R/W	Register Name	Description	Reset Value
0x80	R/W	ALS_CONTR	ALS operation mode control SW reset	0x00
0x81	R/W	PS_CONTR	PS operation mode control	0x00
0x82	R/W	PS_LED	PS LED setting	0x6B
0x83	R/W	PS_N_PULSES	PS number of pulses	0x7F
0x84	R/W	PS_MEAS_RATE	PS measurement rate in active mode	0x02
0x85	R/W	ALS_MEAS_RATE	ALS measurement rate in active mode	0x03
0x86	R	PART_ID	Part Number ID and Revision ID	0x80
0x87	R	MANUFAC_ID	Manufacturer ID	0x05
0x88	R	ALS_DATA_CH1_0	ALS measurement CH1 data, lower byte	0x00
0x89	R	ALS_DATA_CH1_1	ALS measurement CH1 data, upper byte	0x00
0x8A	R	ALS_DATA_CH0_0	ALS measurement CH0 data, lower byte	0x00
0x8B	R	ALS_DATA_CH0_1	ALS measurement CH0 data, upper byte	0x00
0x8C	R	ALS_PS_STATUS	ALS and PS new data status	0x00
0x8D	R	PS_DATA_0	PS measurement data, lower byte	0x00
0x8E	R	PS_DATA_1	PS measurement data, upper byte	0x00
0x8F	R/W	INTERRUPT	Interrupt settings	0x08
0x90	R/W	PS_THRES_UP_0	PS interrupt upper threshold, lower byte	0xFF
0x91	R/W	PS_THRES_UP_1	PS interrupt upper threshold, upper byte	0x07
0x92	R/W	PS_THRES_LOW_0	PS interrupt lower threshold, lower byte	0x00
0x93	R/W	PS_THRES_LOW_1	PS interrupt lower threshold, upper byte	0x00
0x97	R/W	ALS_THRES_UP_0	ALS interrupt upper threshold, lower byte	0xFF
0x98	R/W	ALS_THRES_UP_1	ALS interrupt upper threshold, upper byte	0xFF
0x99	R/W	ALS_THRES_LOW_0	ALS interrupt lower threshold, lower byte	0x00
0x9A	R/W	ALS_THRES_LOW_1	ALS interrupt lower threshold, upper byte	0x00
0x9E	R/W	INTERRUPT PERSIST	ALS/PS Interrupt persist setting	0x00

Notes:

- When reading ALS/PS data registers, read sequence should always be from lower address to higher address (e.g., for ALS data, Ch1 data should be read first followed by Ch0 data. Read sequence should be 0x88, 0x89, 0x8A, 0x8B. When 0x8B is read, all four ALS data registers will be populated with new set of data).
- When setting of INTERRUPT register (addr 0x8F) is necessary, it should be done before the device is in Active mode.

Register Bit Definitions

ALS_CONTR Register (0x80)

The ALS_CONTR register controls the ALS operation modes and software (SW) reset for the sensor. The ALS sensor can be set to either standby mode or active mode. At either of these modes, the I²C circuitry is always active. The default mode after power up is standby mode. During standby mode, there is no ALS measurement performed but I²C communication is allowed to enable read/write to all the registers.

ALS_CONTR (default = 0x00)							
B7	B6	B5	B4	B3	B2	B1	B0
Reserved				ALS Gain	SW Reset	ALS Mode	

Field	Bits	Description
Reserved	7:4	Must write as 0
ALS Gain	3	0: Dynamic Range 2 (2 lux to 64k lux) (default) 1: Dynamic Range 1 (0.01 lux to 320 lux)
SW Reset	2	0: Software reset is NOT started (default) 1: Software reset is started, default value after reset is 0
ALS Mode	1:0	00 / 01: Standby Mode (default) 10 / 11: Active Mode

PS_CONTR Register (0x81)

The PS_CONTR register controls the PS operation modes. The PS sensor can be set to either standby mode or active mode. At either of these modes, the I²C circuitry is always active. The default mode after power up is standby mode. During standby mode, there is no PS measurement performed but I²C communication is allowed to enable read/write to all the registers.

PS_CONTR (default = 0x00)							
B7	B6	B5	B4	B3	B2	B1	B0
Reserved				PS Gain		PS Mode	

Field	Bits	Description
Reserved	7:4	Must write as 0
PS Gain	3:2	00: x1 Gain (default) 01: x4 Gain 10: x8 Gain 11: x16 Gain
PS Mode	1:0	00 / 01: Standby Mode (default) 10 / 11: Active Mode

PS_LED Register (0x82)

The PS_LED register controls the LED pulse modulation frequency, LED current duty cycle and LED peak current.

PS_LED (default = 0x6B)							
B7	B6	B5	B4	B3	B2	B1	B0
LED Pulse Frequency			LED Duty Cycle		LED Peak Current		

Field	Bits	Description
LED Pulse Frequency	7:5	000: 30kHz 001: 40kHz 010: 50kHz 011: 60kHz (default) 100: 70kHz 101: 80kHz 110: 90kHz 111: 100kHz
LED Duty Cycle	4:3	00: 25% 01: 50% (default) 10: 75% 11: 100%
LED Peak Current	2:0	000: 5mA 001: 10mA 010: 20mA 011: 50mA (default) Others: 100mA

PS_N_Pulses Register (0x83)

The PS_N_Pulses register controls the number of LED pulses to be emitted.

PS_N_Pulses (default = 0x7F)							
B7	B6	B5	B4	B3	B2	B1	B0
LED Pulse Count							

Field	Bits	Description
LED Pulse Count	7:0	0000 0000: Number of pulses = 0 0000 0001: Number of pulses = 1 0000 0010: Number of pulses = 2 ... 0000 1111: Number of pulses = 127 (default) ... 1111 1110: Number of pulses = 254 1111 1111: Number of pulses = 255

PS_MEAS_RATE Register (0x84)

The PS_MEAS_RATE register controls the timing of the periodic measurements of the PS in active mode. PS Measurement Repeat Rate is the interval between PS_DATA registers update.

PS_MEAS_RATE (default = 0x02)							
B7	B6	B5	B4	B3	B2	B1	B0
Reserved				PS Measurement Repeat Rate			

Field	Bits	Description
Reserved	7:4	Must write as 0
PS Measurement Repeat Rate	3:0	0000: 50ms 0001: 70ms 0010: 100ms (default) 0011: 200ms 0100: 500ms 0101: 1000ms 0110 / 0111: 2000ms 1XXX: Reserved

ALS_MEAS_RATE Register (0x85)

The ALS_MEAS_RATE register controls the integration time and timing of the periodic measurement of the ALS in active mode. ALS Measurement Repeat Rate is the interval between ALS_DATA registers update. ALS Integration Time is the measurement time for each ALS cycle.

ALS Measurement Repeat Rate must be set to be equal or larger than the ALS Integration Time.

If ALS Measurement Repeat Rate is set to be smaller than ALS Integration Time, it will be automatically reset to be equal to ALS Integration Time by the IC internally.

ALS_MEAS_RATE (default = 0x03)							
B7	B6	B5	B4	B3	B2	B1	B0
Reserved			ALS Integration Time		ALS Measurement Repeat Rate		

Field	Bits	Description
Reserved	7:5	Must write as 0
ALS Integration Time	4:3	00: 100ms (default) 01: 50ms (can only be used in Dynamic Range 2, effective resolution is 15-bit @ 2 lux / count) 10: 200ms (can only be used in Dynamic Range 1) 11: 400ms (can only be used in Dynamic Range 1)
ALS Measurement Repeat Rate	2:0	000: 50ms 001: 100ms 010: 200ms 011: 500ms (default) 100: 1000ms 101 / 110 / 111: 2000ms

PART_ID Register (0x86) (Read Only)

The PART_ID register defines the part number and revision identification of the sensor.

PART_ID (default = 0x80)							
B7	B6	B5	B4	B3	B2	B1	B0
Part Number ID				Revision ID			

Field	Bits	Description
Part Number ID	7:4	0x08H
Revision ID	3:0	0x00H

MANUFAC_ID Register (0x87) (Read Only)

The MANUFAC_ID register defines the manufacturer identification of the sensor.

MANUFAC_ID (default = 0x05)							
B7	B6	B5	B4	B3	B2	B1	B0
Manufacturer ID							

Field	Bits	Description
Manufacturer ID	7:0	0x05H

ALS_DATA_CH1 Register (0x88/0x89) (Read Only)

The ALS_DATA registers should be read as a group, with the lower address read back first (i.e., read 0x88 first, then read 0x89). These two registers should also be read before reading channel-0 data (from registers 0x8A, 0x8B).

When the I²C read operation starts, all four ALS data registers are locked until the I²C read operation of register 0x8B is completed. This will ensure that the data in the registers is from the same measurement even if an additional integration cycle ends during the read operation. New measurement data is stored into temporary registers and the ALS_DATA registers are updated as soon as there is no on-going I²C read operation.

The ALS ADC channel-1 data is expressed as a 16-bit data spread over two registers. The ALS_DATA_CH1_0 and ALS_DATA_CH1_1 registers provide the lower and upper byte respectively.

0x88

ALS_DATA_CH1_0 (default = 0x00)							
B7	B6	B5	B4	B3	B2	B1	B0
ALS Data Ch1 Low							

0x89

ALS_DATA_CH1_1 (default = 0x00)							
B7	B6	B5	B4	B3	B2	B1	B0
ALS Data Ch1 High							

Field	Addr	Bits	Description
ALS Data Ch1 Low	0x88	7:0	ALS ADC channel 1 lower byte data
ALS Data Ch1 High	0x89	7:0	ALS ADC channel 1 upper byte data

ALS_DATA_CH0 Register (0x8A/0x8B) (Read Only)

These two registers should be read after reading channel-1 data (from registers 0x88, 0x89). Lower address register should be read first (i.e read 0x8A first, then read 0x8B). See ALS_DATA_CH1 register information above.

The ALS ADC channel-0 data is expressed as a 16-bit data spread over two registers. The ALS_DATA_CH0_0 and ALS_DATA_CH0_1 registers provide the lower and upper byte respectively.

0x8A

ALS_DATA_CH0_0 (default = 0x00)							
B7	B6	B5	B4	B3	B2	B1	B0
ALS Data Ch0 Low							

0x8B

ALS_DATA_CH0_1 (default = 0x00)							
B7	B6	B5	B4	B3	B2	B1	B0
ALS Data Ch0 High							

Field	Addr	Bits	Description
ALS Data Ch0 Low	0x8A	7:0	ALS ADC channel 0 lower byte data
ALS Data Ch0 High	0x8B	7:0	ALS ADC channel 0 upper byte data

ALS_PS_STATUS Register (0x8C) (Read Only)

The ALS_PS_STATUS register stores the information about interrupt status and ALS and PS data status. New data means data has not been read yet. When the measurement is completed and data is written to the data register, the data status bit will be set to logic 1. When the data register is read, the data status bit will be set to logic 0.

Interrupt status determines if the ALS and PS interrupt criteria are met. It will check if the ALS or PS measurement data is outside of the range defined by the upper and lower threshold limits.

ALS_PS_STATUS (default = 0x00)							
B7	B6	B5	B4	B3	B2	B1	B0
Reserved			ALS Gain	ALS Interrupt Status	ALS Data Status	PS Interrupt Status	PS Data Status

Field	Bits	Description
Reserved	7:5	Do not care
ALS Gain	4	0: ALS measurement data is in dynamic range 2 (2 to 64k lux) 1: ALS measurement data is in dynamic range 1 (0.01 to 320 lux)
ALS Interrupt Status	3	0: ALS interrupt is clear or not yet triggered 1: ALS interrupt is triggered
ALS Data Status	2	0: ALS measurement data is old data (Data has been read) 1: ALS measurement data is new data (Data has not been read)
PS Interrupt Status	1	0: PS interrupt is clear or not yet triggered 1: PS interrupt is triggered
PS Data Status	0	0: PS measurement data is old data (Data has been read) 1: PS measurement data is new data (Data has not been read)

PS_DATA_0 Register (0x8D/0x8E) (Read Only)

The PS ADC channel data are expressed as a 11-bit data spread over two registers. The PS_DATA_0 and PS_DATA_1 registers provide the lower and upper byte respectively. When the I²C read operation starts, both the registers are locked until the I²C read operation is completed. Lower address register should be read first. This will ensure that the data in the registers is from the same measurement even if an additional integration cycle ends during the read operation. New measurement data is stored into temporary registers and the PS_DATA registers are updated as soon as there is no on-going I²C read operation.

0x8D

PS_DATA_0 (default = 0x00)							
B7	B6	B5	B4	B3	B2	B1	B0
PS Data Low							

0x8E

PS_DATA_1 (default = 0x00)							
B7	B6	B5	B4	B3	B2	B1	B0
Reserved				PS Data High			

Field	Addr	Bits	Description
PS Data Low	0x8D	7:0	PS ADC lower byte data
Reserved	0x8E	7:3	Do not care
PS Data High	0x8E	2:0	PS ADC upper byte data

INTERRUPT Register (0x8F)

The INTERRUPT register controls the operation of the interrupt pin and functions. When the Interrupt Mode is set to 00, the INT output pin 2 is inactive / disabled and will not trigger any interrupt. However at this condition, the ALS_PS_STATUS register will still be updated.

Note that when this register is to be set with values other than its default values, it should be set before device is in Active mode.

INTERRUPT (default = 0x08)							
B7	B6	B5	B4	B3	B2	B1	B0
Reserved					Interrupt Polarity	Interrupt Mode	

Field	Bits	Description
Reserved	7:4	Must write as 0
Reserved	3	Do not care
Interrupt Polarity	2	0: INT output pin 2 is considered active when it is a logic 0 (default) 1: INT output pin 2 is considered active when it is a logic 1
Interrupt Mode	1:0	00: INT output pin 2 is inactive / high impedance state (default) 01: Only PS measurement can trigger interrupt 10: Only ALS measurement can trigger interrupt 11: Both ALS and PS measurement can trigger interrupt

PS_THRES Register (0x90 / 0x91 / 0x92 / 0x93)

The PS_THRES_UP and PS_THRES_LOW registers determines the upper and lower limit of the interrupt threshold value respectively. These two values form a range and the interrupt function compares if the measurement value in PS_DATA registers is inside or outside the range. The interrupt function is active if the measurement data is outside the range defined by the upper and lower limits. The data format for PS_THRES must be the same as PS_DATA registers.

0x90

PS_THRES_UP_0 (default = 0xFF)							
B7	B6	B5	B4	B3	B2	B1	B0
PS Upper Threshold Low							

0x91

PS_THRES_UP_1 (default = 0x07)							
B7	B6	B5	B4	B3	B2	B1	B0
Reserved				PS Upper Threshold High			

0x92

PS_THRES_LOW_0 (default = 0x00)							
B7	B6	B5	B4	B3	B2	B1	B0
PS Lower Threshold Low							

0x93

PS_THRES_LOW_1 (default = 0x00)							
B7	B6	B5	B4	B3	B2	B1	B0
Reserved				PS Lower Threshold High			

Field	Addr	Bits	Description
PS Upper Threshold Low	0x90	7:0	PS upper threshold lower byte
Reserved	0x91	7:3	Must write as 0
PS Upper Threshold High	0x91	2:0	PS upper threshold upper byte
PS Lower Threshold Low	0x92	7:0	PS lower threshold lower byte
Reserved	0x93	7:3	Must write as 0
PS Lower Threshold High	0x93	2:0	PS lower threshold upper byte

ALS_THRES Register (0x97 / 0x98 / 0x99 / 0x9A)

The ALS_THRES_UP and ALS_THRES_LOW registers determines the upper and lower limit of the interrupt threshold value respectively. These two values form a range and the interrupt function compares if the measurement value in ALS_DATA registers is inside or outside the range. The interrupt function is active if the measurement data is outside the range defined by the upper and lower limits. The data format for ALS_THRES must be the same as ALS_DATA registers.

0x97

ALS_THRES_UP_0 (default = 0xFF)							
B7	B6	B5	B4	B3	B2	B1	B0
ALS Upper Threshold Low							

0x98

ALS_THRES_UP_1 (default = 0xFF)							
B7	B6	B5	B4	B3	B2	B1	B0
ALS Upper Threshold High							

0x99

ALS_THRES_LOW_0 (default = 0x00)							
B7	B6	B5	B4	B3	B2	B1	B0
ALS Lower Threshold Low							

0x9A

ALS_THRES_LOW_1 (default = 0x00)							
B7	B6	B5	B4	B3	B2	B1	B0
ALS Lower Threshold High							

Field	Addr	Bits	Description
ALS Upper Threshold Low	0x97	7:0	ALS upper threshold lower byte
ALS Upper Threshold High	0x98	7:0	ALS upper threshold upper byte
ALS Lower Threshold Low	0x99	7:0	ALS lower threshold lower byte
ALS Lower Threshold High	0x9A	7:0	ALS lower threshold upper byte

INTERRUPT PERSIST Register (0x9E)

The INTERRUPT PERSIST register controls the N number of times the measurement data is outside the range defined by the upper and lower threshold limits before asserting the INT output pin 2.

INTERRUPT PERSIST (default = 0x00)							
B7	B6	B5	B4	B3	B2	B1	B0
PS Persist				ALS Persist			

Field	Bits	Description
PS Persist	7:4	0000: Every PS measurement data will generate an interrupt (default) 0001: 1 consecutive PS measurement data outside the range 0010: 2 consecutive PS measurement data outside the range ... 1111: 15 consecutive PS measurement data outside the range
ALS Persist	3:0	0000: Every ALS measurement data will generate an interrupt (default) 0001: 1 consecutive ALS measurement data outside the range 0010: 2 consecutive ALS measurement data outside the range ... 1111: 15 consecutive ALS measurement data outside the range

Package Dimensions

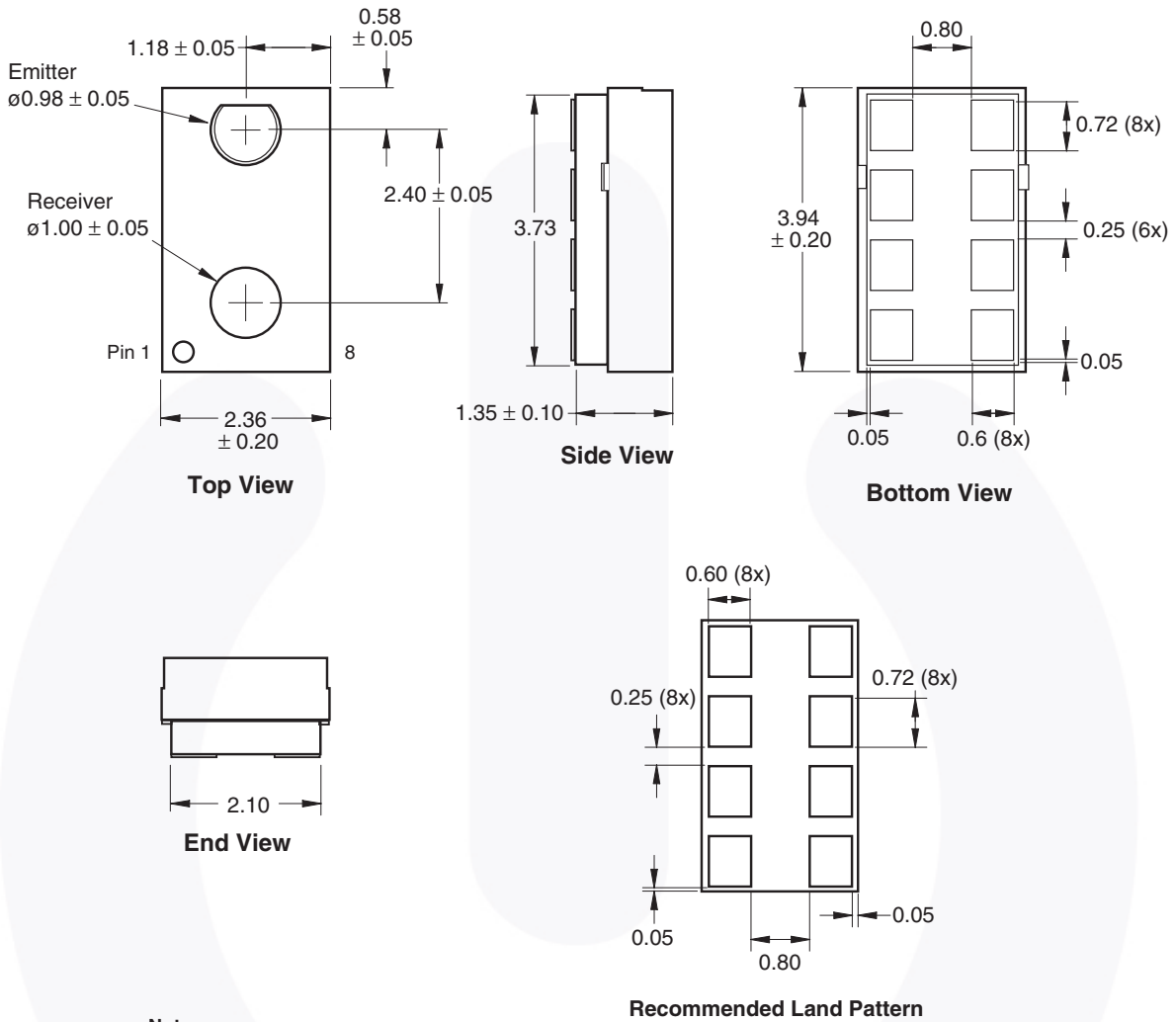

Note:
1. All units in mm.

Typical Application Circuit

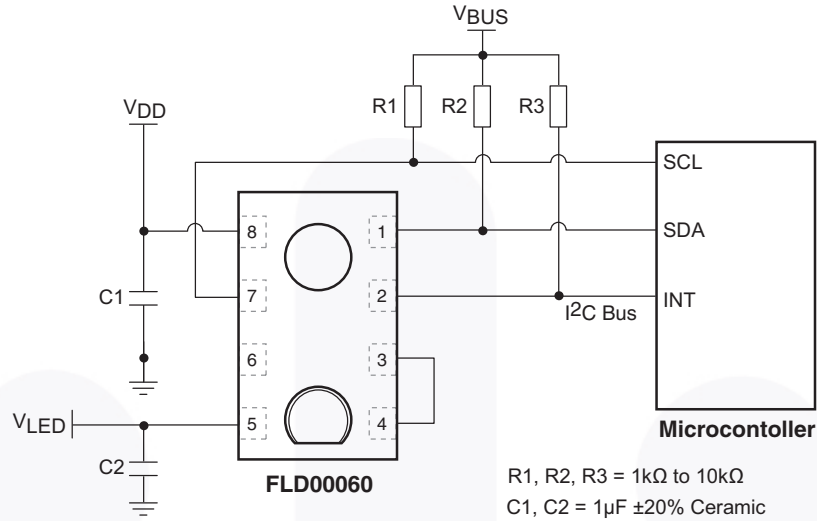

Optical Design Recommendations

The performance of the device in the application depends on its characteristics as well as the way the device is mounted on the end system.

The critical aspect of the end system mechanical design is the optimization of the optical path between the device and the space around, which is governed by:

- The size of the glass or plastic window so that light is not blocked by the adjacent opaque surfaces.
- The thickness of the window.
- The transmittance of the window material.
- The distance from the device to the window.

The dimensional recommendations are shown in the diagram below.

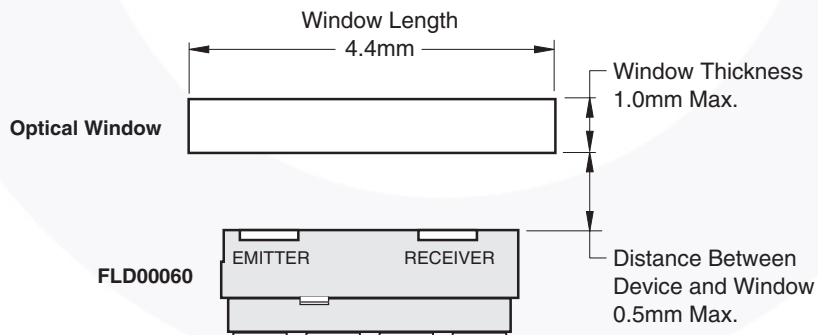

NOTE: Not to scale

Side View of Recommended Mounting

Regarding the transmittance, the window material should be selected based on its transmittance in the visible spectrum and the infrared spectrum (400nm to 900nm). The range of the proximity sensing function will increase with the transmittance.

Tape and Reel Dimensions

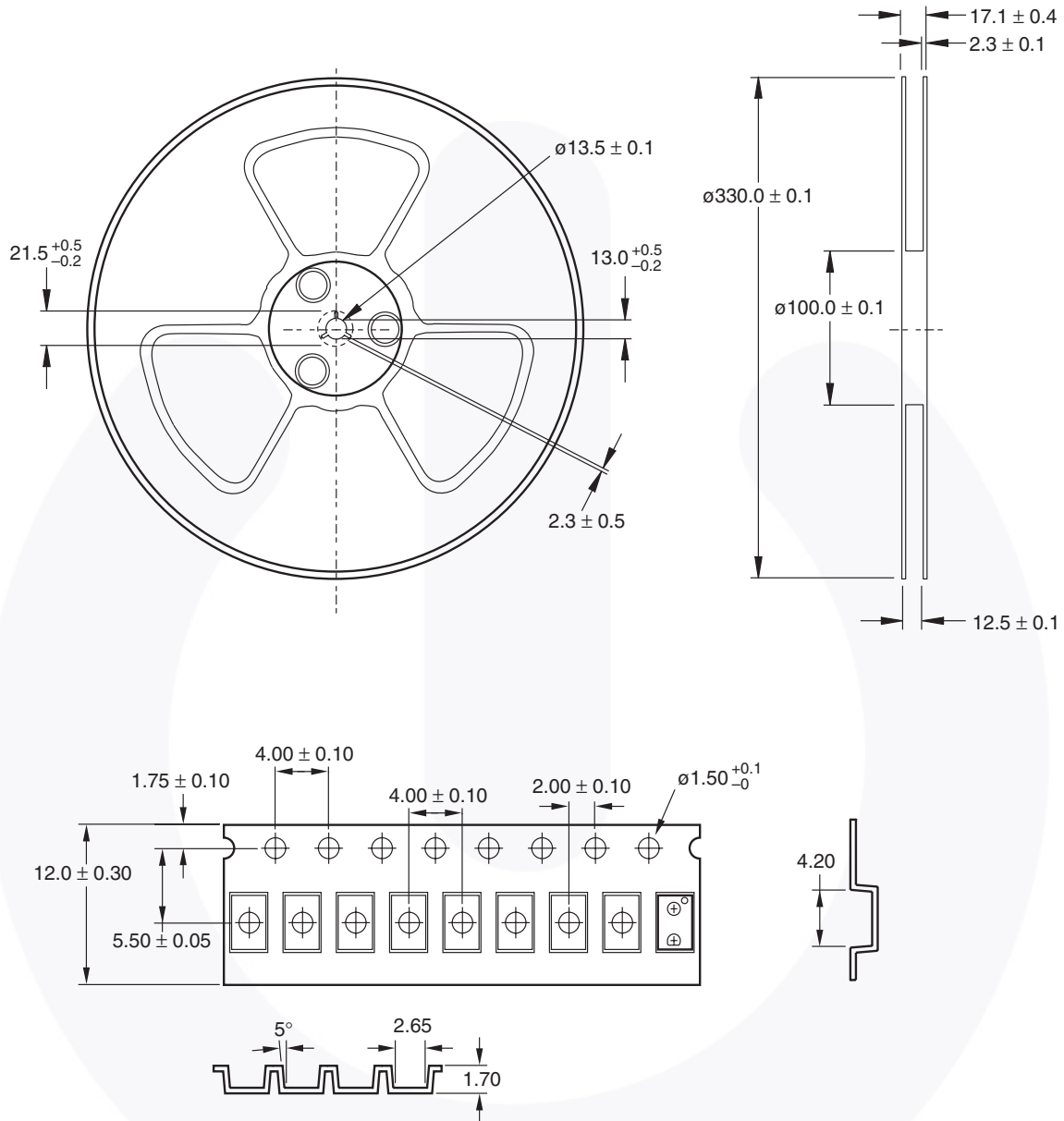

Note:

1. All units in mm.
2. Empty component pockets sealed with top cover tape
3. 13 inch reel: 5,000 pieces per reel
4. In accordance with ANSI/EIA 481-1-A-1994 specifications

Reflow Profile

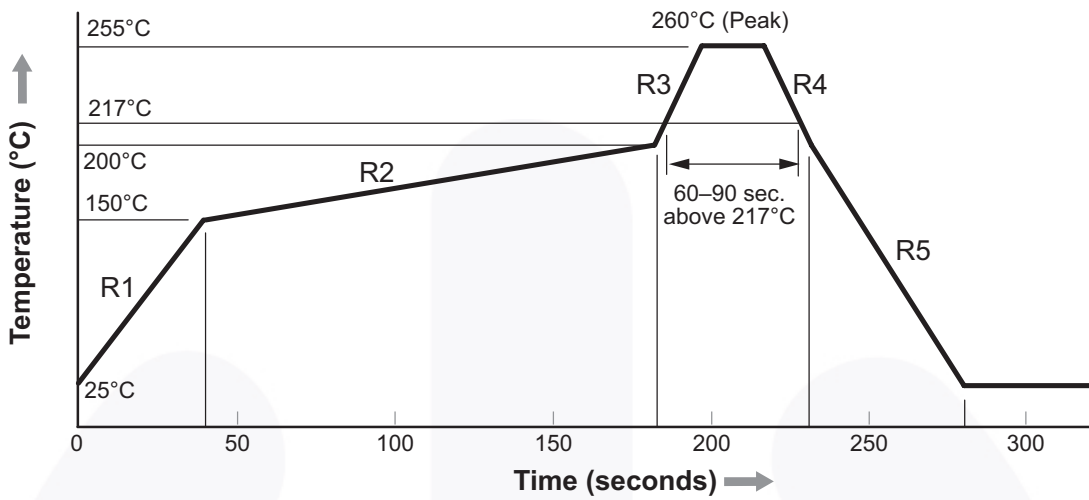

Notes:





1. Reflow soldering should not be done more than twice.
2. When soldering, do not put stress on the devices during heating.
3. After soldering, do not warp the circuit board.

Symbol	Process Zone	Δ Temp	Maximum Δ Temp/ Δ Time or Duration
R1	Heat Up	25°C to 150°C	3°C/s
R2	Solder Paste Dry	150°C to 200°C	100s to 180s
R3	Solder Reflow	200°C to 260°C	3°C/s
R4		260°C to 200°C	-6°C/s
R5	Cool Down	200°C to 25°C	-6°C/s
Time Maintained Above Liquidus Point, 217°C		>217°C	60 to 90 seconds
Peak Temperature		260°C	
Time Within 5°C of Actual Peak Temperature		>255°C	20 seconds
Time 25°C to Peak Temperature		25°C to 260°C	8 minutes



TRADEMARKS

The following includes registered and unregistered trademarks and service marks, owned by Fairchild Semiconductor and/or its global subsidiaries, and is not intended to be an exhaustive list of all such trademarks.

- | | | | |
|--|---|--|---|
| 2Cool™ | F-PFS™ | PowerTrench® | The Power Franchise® |
| AccuPower™ | FRFET® | PowerXS™ | the power franchise |
| AX-CAP™* | Global Power Resource™ | Programmable Active Droop™ | TinyBoost™ |
| BitSiC™ | GreenBridge™ | QFET® | TinyBuck™ |
| Build it Now™ | Green FPS™ | QS™ | TinyCalc™ |
| CorePLUS™ | Green FPS™ e-Series™ | Quiet Series™ | TinyLogic® |
| CorePOWER™ | Gmax™ | RapidConfigure™ | TINYOPTO™ |
| CROSSVOLT™ | GTO™ |  ™ | TinyPower™ |
| CTL™ | IntelliMAX™ | Saving our world, 1mW/W/kW at a time™ | TinyPWM™ |
| Current Transfer Logic™ | ISOPLANAR™ | SignalWise™ | TinyWire™ |
| DEUXPEED® | Making Small Speakers Sound Louder and Better™ | SmartMax™ | TranSiC™ |
| Dual Cool™ | MegaBuck™ | SMART START™ | TriFault Detect™ |
| EcoSPARK® | MICROCOUPLER™ | Solutions for Your Success™ | TRUECURRENT®* |
| EfficientMax™ | MicroFET™ | SPM® | μSerDes™ |
| ESBC™ | MicroPak™ | STEALTH™ |  SerDes™ |
|  Fairchild® | MicroPak2™ | SuperFET® | UHC® |
| Fairchild Semiconductor® | MillerDrive™ | SuperSOT™-3 | Ultra FRFET™ |
| FACT Quiet Series™ | MotionMax™ | SuperSOT™-6 | UniFET™ |
| FACT® | mWSaver™ | SuperSOT™-8 | VCX™ |
| FAST® | OptoHiT™ | SupreMOS® | VisualMax™ |
| FastvCore™ | OPTOLOGIC® | SyncFET™ | VoltagePlus™ |
| FETBench™ | OPTOPLANAR® | Sync-Lock™ | XS™ |
| FlashWriter®* |  ™ |  SYSTEM GENERAL®* | |
| FPS™ | | | |

* Trademarks of System General Corporation, used under license by Fairchild Semiconductor.

DISCLAIMER

FAIRCHILD SEMICONDUCTOR RESERVES THE RIGHT TO MAKE CHANGES WITHOUT FURTHER NOTICE TO ANY PRODUCTS HEREIN TO IMPROVE RELIABILITY, FUNCTION, OR DESIGN. FAIRCHILD DOES NOT ASSUME ANY LIABILITY ARISING OUT OF THE APPLICATION OR USE OF ANY PRODUCT OR CIRCUIT DESCRIBED HEREIN; NEITHER DOES IT CONVEY ANY LICENSE UNDER ITS PATENT RIGHTS, NOR THE RIGHTS OF OTHERS. THESE SPECIFICATIONS DO NOT EXPAND THE TERMS OF FAIRCHILD'S WORLDWIDE TERMS AND CONDITIONS, SPECIFICALLY THE WARRANTY THEREIN, WHICH COVERS THESE PRODUCTS.

LIFE SUPPORT POLICY

FAIRCHILD'S PRODUCTS ARE NOT AUTHORIZED FOR USE AS CRITICAL COMPONENTS IN LIFE SUPPORT DEVICES OR SYSTEMS WITHOUT THE EXPRESS WRITTEN APPROVAL OF FAIRCHILD SEMICONDUCTOR CORPORATION.

As used herein:

1. Life support devices or systems are devices or systems which, (a) are intended for surgical implant into the body or (b) support or sustain life, and (c) whose failure to perform when properly used in accordance with instructions for use provided in the labeling, can be reasonably expected to result in a significant injury of the user.
2. A critical component in any component of a life support, device, or system whose failure to perform can be reasonably expected to cause the failure of the life support device or system, or to affect its safety or effectiveness.

ANTI-COUNTERFEITING POLICY

Fairchild Semiconductor Corporation's Anti-Counterfeiting Policy. Fairchild's Anti-Counterfeiting Policy is also stated on our external website, www.fairchildsemi.com, under Sales Support.

Counterfeiting of semiconductor parts is a growing problem in the industry. All manufacturers of semiconductor products are experiencing counterfeiting of their parts. Customers who inadvertently purchase counterfeit parts experience many problems such as loss of brand reputation, substandard performance, failed applications, and increased cost of production and manufacturing delays. Fairchild is taking strong measures to protect ourselves and our customers from the proliferation of counterfeit parts. Fairchild strongly encourages customers to purchase Fairchild parts either directly from Fairchild or from Authorized Fairchild Distributors who are listed by country on our web page cited above. Products customers buy either from Fairchild directly or from Authorized Fairchild Distributors are genuine parts, have full traceability, meet Fairchild's quality standards for handling and storage and provide access to Fairchild's full range of up-to-date technical and product information. Fairchild and our Authorized Distributors will stand behind all warranties and will appropriately address any warranty issues that may arise. Fairchild will not provide any warranty coverage or other assistance for parts bought from Unauthorized Sources. Fairchild is committed to combat this global problem and encourage our customers to do their part in stopping this practice by buying direct or from authorized distributors.

PRODUCT STATUS DEFINITIONS

Definition of Terms

Datasheet Identification	Product Status	Definition
Advance Information	Formative / In Design	Datasheet contains the design specifications for product development. Specifications may change in any manner without notice.
Preliminary	First Production	Datasheet contains preliminary data; supplementary data will be published at a later date. Fairchild Semiconductor reserves the right to make changes at any time without notice to improve design.
No Identification Needed	Full Production	Datasheet contains final specifications. Fairchild Semiconductor reserves the right to make changes at any time without notice to improve the design.
Obsolete	Not In Production	Datasheet contains specifications on a product that is discontinued by Fairchild Semiconductor. The datasheet is for reference information only.

Rev. I62

ON Semiconductor and  are trademarks of Semiconductor Components Industries, LLC dba ON Semiconductor or its subsidiaries in the United States and/or other countries. ON Semiconductor owns the rights to a number of patents, trademarks, copyrights, trade secrets, and other intellectual property. A listing of ON Semiconductor's product/patent coverage may be accessed at www.onsemi.com/site/pdf/Patent-Marking.pdf. ON Semiconductor reserves the right to make changes without further notice to any products herein. ON Semiconductor makes no warranty, representation or guarantee regarding the suitability of its products for any particular purpose, nor does ON Semiconductor assume any liability arising out of the application or use of any product or circuit, and specifically disclaims any and all liability, including without limitation special, consequential or incidental damages. Buyer is responsible for its products and applications using ON Semiconductor products, including compliance with all laws, regulations and safety requirements or standards, regardless of any support or applications information provided by ON Semiconductor. "Typical" parameters which may be provided in ON Semiconductor data sheets and/or specifications can and do vary in different applications and actual performance may vary over time. All operating parameters, including "Typicals" must be validated for each customer application by customer's technical experts. ON Semiconductor does not convey any license under its patent rights nor the rights of others. ON Semiconductor products are not designed, intended, or authorized for use as a critical component in life support systems or any FDA Class 3 medical devices or medical devices with a same or similar classification in a foreign jurisdiction or any devices intended for implantation in the human body. Should Buyer purchase or use ON Semiconductor products for any such unintended or unauthorized application, Buyer shall indemnify and hold ON Semiconductor and its officers, employees, subsidiaries, affiliates, and distributors harmless against all claims, costs, damages, and expenses, and reasonable attorney fees arising out of, directly or indirectly, any claim of personal injury or death associated with such unintended or unauthorized use, even if such claim alleges that ON Semiconductor was negligent regarding the design or manufacture of the part. ON Semiconductor is an Equal Opportunity/Affirmative Action Employer. This literature is subject to all applicable copyright laws and is not for resale in any manner.

PUBLICATION ORDERING INFORMATION

LITERATURE FULFILLMENT:

Literature Distribution Center for ON Semiconductor
19521 E. 32nd Pkwy, Aurora, Colorado 80011 USA
Phone: 303-675-2175 or 800-344-3860 Toll Free USA/Canada
Fax: 303-675-2176 or 800-344-3867 Toll Free USA/Canada
Email: orderlit@onsemi.com

N. American Technical Support: 800-282-9855 Toll Free
USA/Canada
Europe, Middle East and Africa Technical Support:
Phone: 421 33 790 2910
Japan Customer Focus Center
Phone: 81-3-5817-1050

ON Semiconductor Website: www.onsemi.com
Order Literature: <http://www.onsemi.com/orderlit>
For additional information, please contact your local
Sales Representative