

High-Speed(10+Gbps) BGA Mezzanine Connectors

IT3 Series

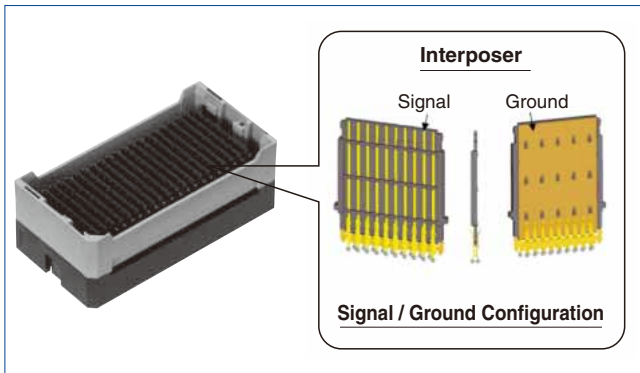
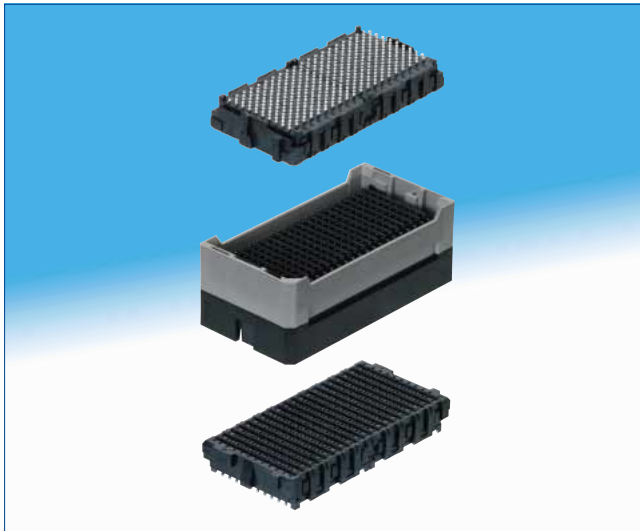

Flexibility

Hirose's IT3 mezzanine connector system is as comfortable in today's data rates of PCIe and XAUI as it is in tomorrow's 10+Gbps systems. With the ability to transmit differential, single-ended, and power through one package and being stackable from 14 – 40mm, IT3 can solve your interface needs for both current and future generations.

Mechanical features

- Unique 3-piece structure for flexibility
- Stacking heights from 14 to 40mm
- Staggered 1.5mm × 1.75mm ball grid array
- Number of Contacts: 100, 200, &300 signals + 90% additional grounds
- Differential, single-ended, and power
- Low mating/extracting forces
- Wide misalignment tolerances for multiple connector use
- Both of SnPb and Pb-free are available
- Excellent reflow solderability
- IT3 is inter-mateable with IT5 Series

Signal integrity features

Insertion loss to Crosstalk Ratio (ICR)

The ICR performance meets the extrapolated IEEE 802.3ap specification for 6.25Gbps with fully-populated pin assignment, and 10+Gbps with skipped pin assignment.

Return Loss

The differential return loss meets the extrapolated IEEE 802.3ap specification up to 12GHz.

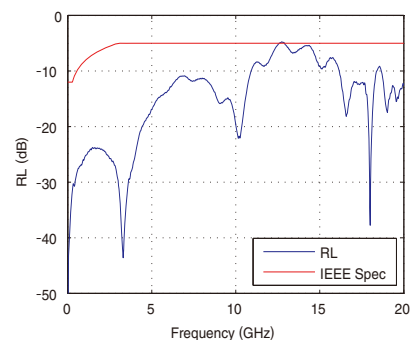
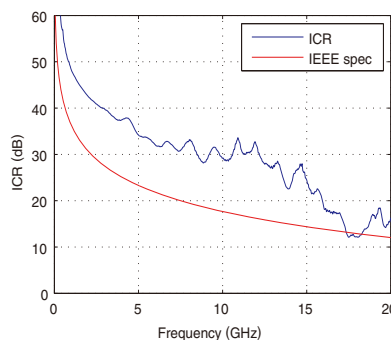

Stacking height variations

Stacking Height Contact Position	2piece		3piece											
	14 mm	15 mm	17 mm	18 mm	20 mm	22 mm	25 mm	26 mm	28 mm	30 mm	32 mm	35 mm	38 mm	40 mm
100	✓	✓	✓	✓	✓	✓	✓	✓	✓	*	✓	✓	✓	✓
200	✓	✓	✓	✓	✓	✓	✓	✓	✓	✓	✓	✓	✓	*
300	✓	✓	✓	✓	✓	✓	✓	✓	✓	✓	✓	✓	✓	✓

* : Under planning

■Product Specifications

Rating	Current Rating : 1.0A / pin (note 1)	Operating Temperature Range: -55°C to +85°C
	Voltage Rating : 50Vrms	Operating Humidity Range: For relative humidity, 90% max (no condensation is permitted)
	Storage Temperature Range : -10°C to +60°C	

Item	Specification	Conditions
1. Insulation Resistance	1000MΩ min.	100V DC
2. Withstanding Voltage	No flashover or insulation breakdown	150V duty for 60 seconds (2mA max leak)
3. Contact Resistance	40mΩ max. (height 14-15mm) 50mΩ max. (height 17-24mm) (note 2) 55mΩ max. (height 25-32mm) (note 2) 60mΩ max. (height 33-40mm) (note 2)	100mA
4. Vibration	1) No electrical discontinuity of 1μs or more 2) No damage, crack, or loose part	Frequency : 50 to 2000Hz; power spectrum density : 0.1G ² /Hz for 90 minutes in three directions
5. Cyclic Temperature and Humidity	1) Contact resistance change: 20mΩ or less 2) No damage, crack or loose part	25°C, 80% RH : 60 min dwell time, 30 min ramp time 65°C, 50% RH : 60 min dwell time under 24 cycles
6. Durability (Mating/Un-mating)	1) Contact resistance change: 20mΩ or less 2) No damage, crack or loose part	100 cycles

Note1 : Refer to IT3 derating curves on test report TR636E-20041 for power application.

Note2 : The value of contact resistance includes 2 contact points and the bulk resistance.

■Materials / Finish

●Receptacle

Component	Material	Finish & Remarks
Housing(Mounting Side)	LCP	Black , UL 94V-0
Housing(Detachable / Mating Side)	LCP	Gray , UL 94V-0
Locator	LCP	Black , UL 94V-0
Contact	Copper Alloy	Contact Area : Gold (0.76 μm) over Nickel (1.5 μm) Mounting Area : Gold (0.05 μm) over Nickel (1.5 μm) Other : Nickel (1.5 μm)
Solder Ball	Tin-Lead (SnPb) Tin (Pb-Free)	Sn(63)-Pb(37) Sn(96.5)-Ag(3)-Cu(0.5)
Tray	Polystyrene	Black
Pick Up Cap	Stainless steel	300pos
Pick Up Tape	Paper (Nomex)	100pos and 200pos

●Interposer

Component	Material	Finish & Remarks
Guide (Mounting Side)	PBT	Black , UL 94V-0
Guide (Detachable/Mating Side)	LCP	Gray , UL 94V-0
	PBT	Gray , UL 94V-0
Blade	LCP	Black , UL 94V-0
Contact	Copper Alloy	Contact Area : Gold (0.76 μm) over Nickel (1.5 μm) Other : Nickel (1.5 μm)
Ground Shield	Copper Alloy	
Tray	Polypropylene	—

●Plug

Component	Material	Finish & Remarks
Housing	LCP	Black , UL 94V-0
Locator	LCP	Black , UL 94V-0
Contact	Copper Alloy	Contact Area : Gold (0.76 μm) over Nickel (1.5 μm) Mounting Area : Gold (0.05 μm) over Nickel (1.5 μm) Other : Nickel (1.5 μm)
Solder Ball	Tin-Lead (SnPb) Tin (Pb-Free)	Sn(63)-Pb(37) Sn(96.5)-Ag(3)-Cu(0.5)
Tray	Polystyrene	Blue
Pick Up Cap	Stainless steel	100pos, 200pos and 300pos

Product Number Structure

Refer to the chart below when determining the product specifications from the product number. Please select from the product numbers listed in this catalog when placing orders.

● Receptacle

IT 3 ** - * S - BGA ** (**)**
 ① ② ③ ④ ⑤ ⑥ ⑦

● Interposer

IT 3 ** - * P - ** H ** (**)**
 ① ② ③ ④ ⑤ ⑥ ⑦

● Plug

IT 3 ** - * P - ** BGA ** (**)**
 ① ② ③ ④ ⑤ ⑥ ⑦

① Series name : IT3	⑦ Material and Plating Specification of Mounting Receptacle, plug Housing : Black (37) : Pb-free Solder Sn(96.5)-Ag(3.0)-Cu(0.5) Contact Area : Au(0.76μm)+Ni(1.5μm) (57) : Eutectic Solder Sn(63)-Pb(37) Contact Area : Au(0.76μm)+Ni(1.5μm) Material and Plating Specification of Mating Receptacle Housing : Glay (39) : Pb-free Solder Sn(96.5)-Ag(3.0)-Cu(0.5) Contact Area : Au(0.76μm)+Ni(1.5μm) (59) : Eutectic Solder Sn(63)-Pb(37) Contact Area : Au(0.76μm)+Ni(1.5μm)
② Receptacle Type D : Mating Receptacle D* : Mating Receptacle (Customized) M : Mounting Receptacle M* : Mounting Receptacle (Customized) Interposer Type Blank : Standard ** : Customized Plug Type M : Plug M* : Plug (Customized)	⑧ Stacking Height (mm) 14, 15, 17, 18, 20, 22, 25, 26, 28, 30, 32, 35, 38, 40 Plug : 14, 15 Interposer : 17, 40
③ Contact Positions : 100, 200, 300	⑨ Plating Specification of Interposer (03), (04) : Contact Area : Au(0.76μm)+Ni(1.5μm)
④ Connector type S : Receptacle P : Interposer , Plug	
⑤ BGA : Ball Grid Array	
⑥ Package Specification Blank : Standard ** : Customized	

Signal Integrity

● Pin assignment

For the fully-populated pin assignment, adjacent pins are grouped into differential pairs as shown in the figures below. In the following data, one victim pair and eight aggressor pairs are included.

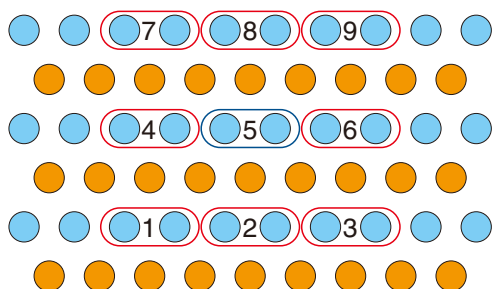

Mating receptacle side

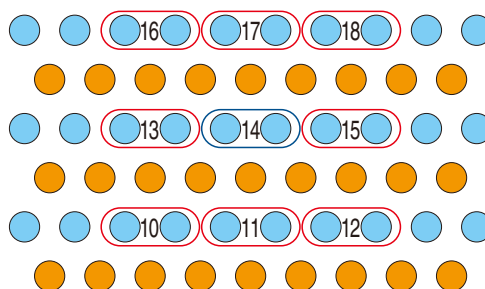

Mounting receptacle side



● Impedance profile at 60ps rise time (20-80%)

The impedance profiles (of connector only) for the center pair are shown below. The IT3 receptacles are designed with higher impedance to offset the via's low impedance.

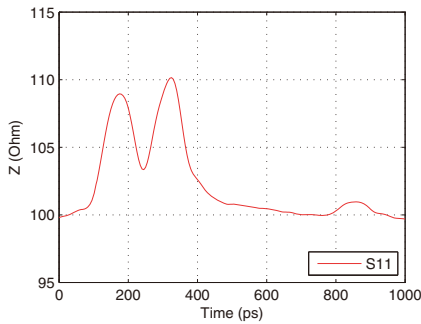

17mm Height

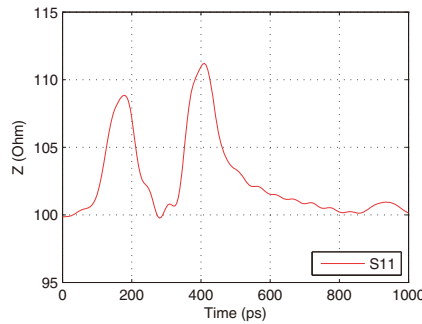

25mm Height

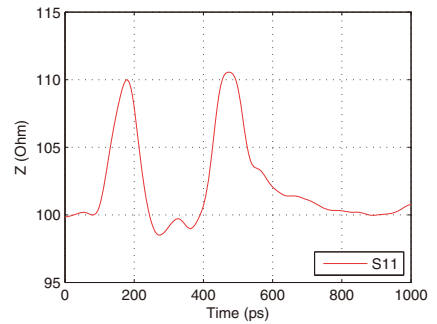

32mm Height

● Differential propagation delay

Stacking Height (mm)	17	25	32
Delay (ps)	101.05	146.69	188.48

● Differential Insertion Loss

The differential insertion loss is less than -2dB up to 12GHz.

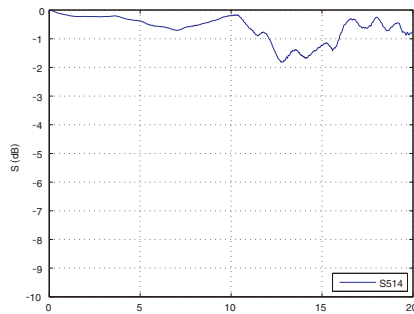

17mm Height

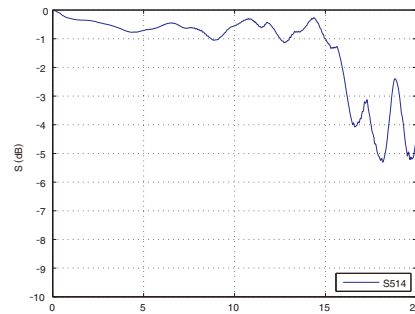

25mm Height

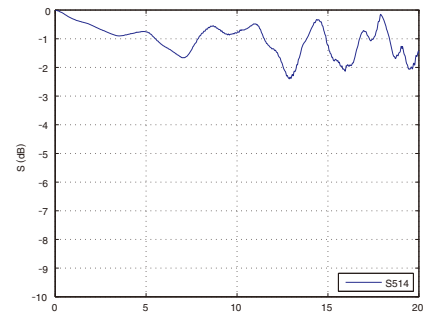

32mm Height

● Differential Return Loss

The connector-only differential return loss for the center pair meets the extrapolated IEEE 802.3ap spec up to 12GHz. (The attenuation of PCB traces in the channel will give an even larger margin.)

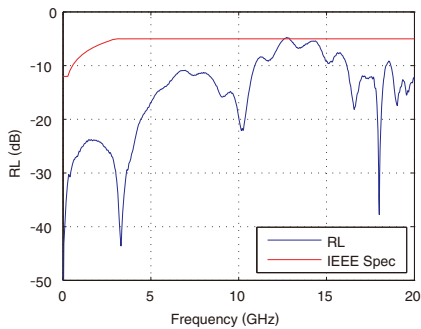

17mm Height

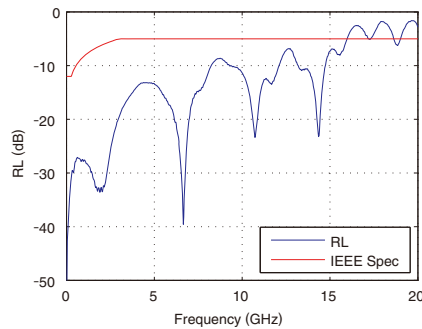

25mm Height

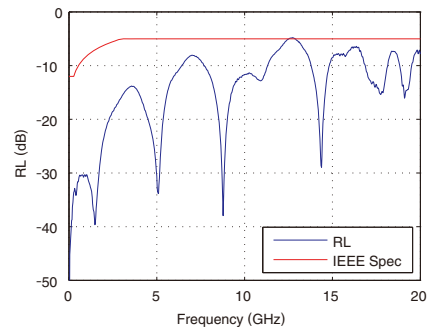

32mm Height

Differential Near-End Crosstalk (NEXT)

The near-end crosstalk at the center pair from surrounding 8 aggressors is shown below. The NEXT is not as critical because TX and RX can be grouped into separate wafers.

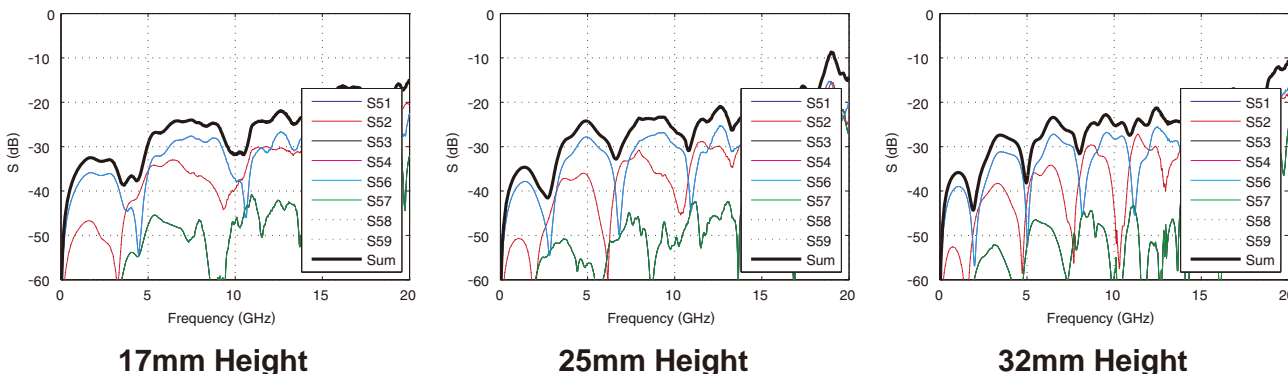

Differential Far-End Crosstalk (FEXT)

Low far-end crosstalk at the center pair from surrounding 8 aggressors is observed. Even lower crosstalk can be achieved by skipping pins.

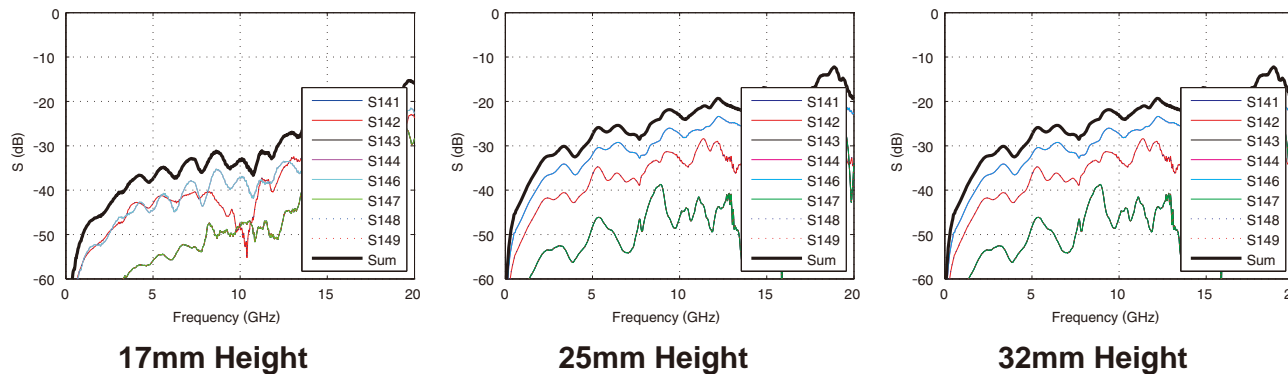

Insertion-Loss-to-Crosstalk-Ratio (ICR) for FEXT

The insertion-loss-to-crosstalk-ratio (ICR) for 8-aggressor FEXT meets the extrapolated IEEE 802.3ap specification up to 12GHz.

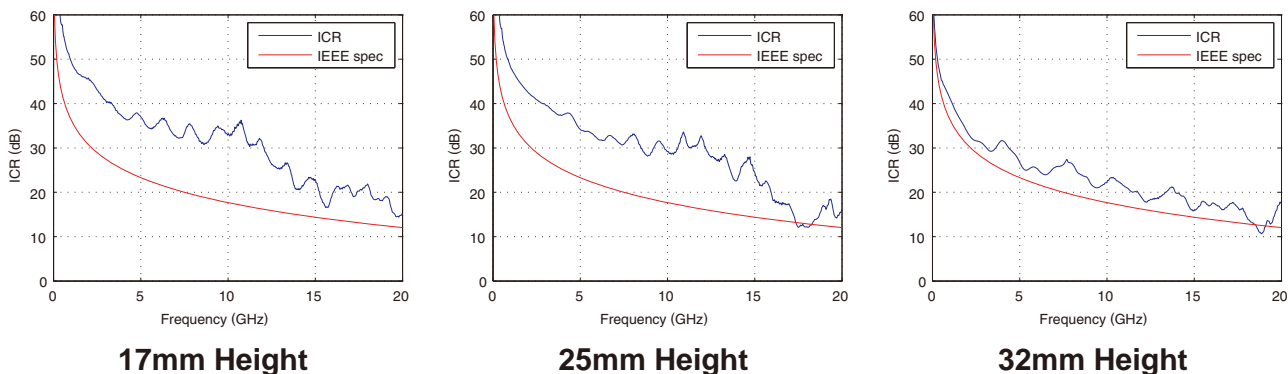

Feb.1.2018 Copyright 2018 HIROSE ELECTRIC CO., LTD. All Rights Reserved.

■ Receptacle

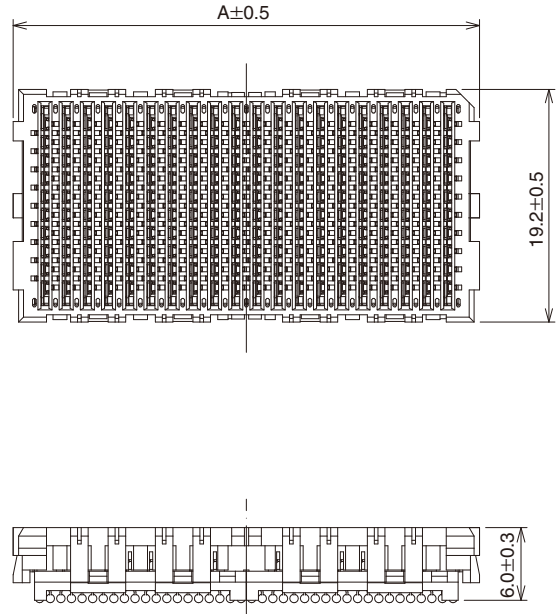

Shown: 200 position mounting receptacle, IT3M-200S-BGA

*Unit : mm

Contact Positions	Type	Solder Ball Material	Part No.	HRS No.	A
100 (100 signals/90 grounds)	Mating Receptacle	Pb-free (SAC305) solder	IT3D-100S-BGA(39)	636-0013-1 39	21.0
		SnPb solder	IT3D-100S-BGA(59)	636-0013-1 59	
	Mounting Receptacle	Pb-free (SAC305) solder	IT3M-100S-BGA(37)	636-0014-4 37	
		SnPb solder	IT3M-100S-BGA(57)	636-0014-4 57	
200 (200 signals/180 grounds)	Mating Receptacle	Pb-free (SAC305) solder	IT3D-200S-BGA(39)	636-0003-8 39	38.5
		SnPb solder	IT3D-200S-BGA(59)	636-0003-8 59	
	Mounting Receptacle	Pb-free (SAC305) solder	IT3M-200S-BGA(37)	636-0004-0 37	
		SnPb solder	IT3M-200S-BGA(57)	636-0004-0 57	
300 (300 signals/270 grounds)	Mating Receptacle	Pb-free (SAC305) solder	IT3D-300S-BGA(39)	636-0007-9 39	56.0
		SnPb solder	IT3D-300S-BGA(59)	636-0007-9 59	
	Mounting Receptacle	Pb-free (SAC305) solder	IT3M-300S-BGA(37)	636-0008-1 37	
		SnPb solder	IT3M-300S-BGA(57)	636-0008-1 57	

Interposer

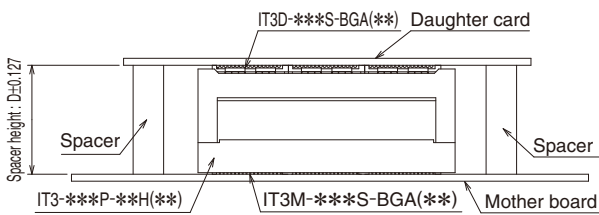
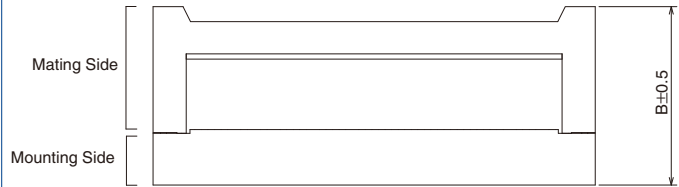
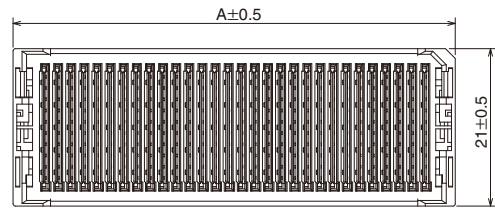
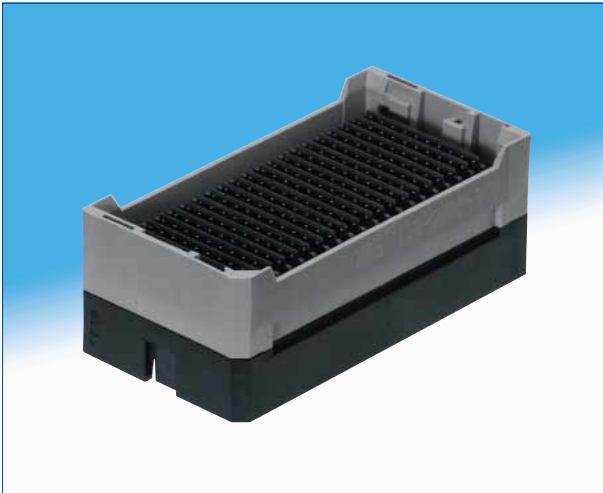

Mating condition with spacers

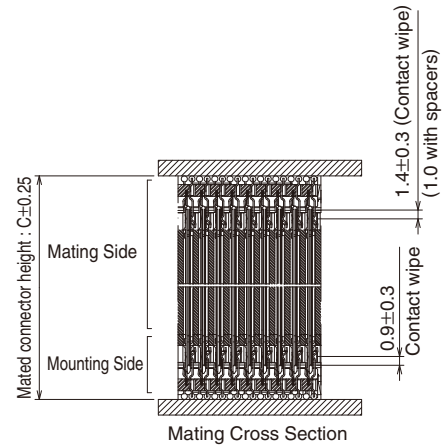

Mating condition without spacers

*Unit : mm

Height (mm)	Part No.	HRS No.	A	B	C	D	Height (mm)	Part No.	HRS No.	A	B	C	D
17	IT3-100P-17H(04)	636-0265-4 04	24.0	15.8	16.6	17.0	28	IT3-100P-28H(04)	636-0170-0 04	24.0	26.8	27.6	28.0
	IT3-200P-17H(04)	636-0100-4 04	41.5					IT3-200P-28H(04)	636-0105-8 04	41.5			
	IT3-300P-17H(04)	636-0130-5 04	59.0					IT3-300P-28H(04)	636-0140-9 04	59.0			
18	IT3-100P-18H(03)	636-0250-7 03	24.0	16.8	17.6	18.0	30	IT3-200P-30H(04)	636-0180-3 04	41.5	28.8	29.6	30.0
	IT3-200P-18H(03)	636-0252-2 03	41.5					IT3-300P-30H(04)	636-0185-7 04	59.0			
	IT3-300P-18H(03)	636-0254-8 03	59.0					IT3-100P-32H(04)	636-0266-7 04	24.0			
20	IT3-100P-20H(03)	636-0223-4 03	24.0	18.8	19.6	20.0	32	IT3-200P-32H(04)	636-0115-1 04	41.5	30.8	31.6	32.0
	IT3-200P-20H(03)	636-0224-7 03	41.5					IT3-300P-32H(04)	636-0145-2 04	59.0			
	IT3-300P-20H(03)	636-0225-0 03	59.0					IT3-100P-35H(03)	636-0239-4 03	24.0			
22	IT3-100P-22H(03)	636-0264-1 03	24.0	20.8	21.6	22.0	35	IT3-200P-35H(03)	636-0240-3 03	41.5	33.8	34.6	35.0
	IT3-200P-22H(03)	636-0209-3 03	41.5					IT3-300P-35H(03)	636-0241-6 03	59.0			
	IT3-300P-22H(03)	636-0210-2 03	59.0					IT3-100P-38H(03)	636-0200-9 03	24.0			
25	IT3-100P-25H(04)	636-0150-2 04	24.0	23.8	24.6	25.0	38	IT3-200P-38H(03)	636-0195-0 03	41.5	36.8	37.6	38.0
	IT3-200P-25H(04)	636-0155-6 04	41.5					IT3-300P-38H(03)	636-0190-7 03	59.0			
	IT3-300P-25H(04)	636-0160-6 04	59.0					IT3-100P-40H(03)	636-0230-0 03	24.0			
26	IT3-100P-26H(04)	636-0165-0 04	24.0	24.8	25.6	26.0	40	IT3-200P-40H(03)	636-0230-0 03	24.0	38.8	39.6	40.0
	IT3-300P-26H(04)	636-0135-9 04	59.0					IT3-300P-40H(03)	636-0175-3 03	59.0			

■ Plug

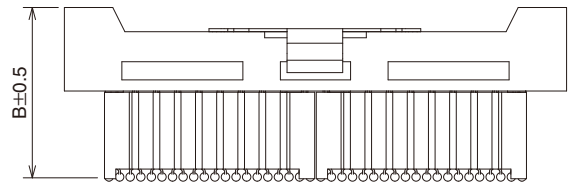
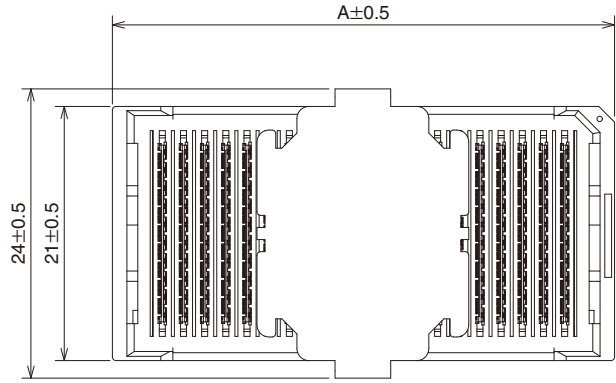

Shown : 200 position mounting plug, IT3M-200P-15BGA

*Unit : mm

Height (mm)	Solder Ball Material	Part No.	HRS No.	A	B
14	Pb-Free(SAC305) solder	IT3M-100P-14BGA(37)	636-0511-9 37	24.0	13.15
		IT3M-200P-14BGA(37)	636-0508-4 37	41.5	
		IT3M-300P-14BGA(37)	636-0507-1 37	59.0	
15	Pb-Free(SAC305) solder	IT3M-100P-15BGA(37)	636-0504-3 37	24.0	14.15
	Sn-Pb solder	IT3M-100P-15BGA(57)	636-0504-3 57		
	Pb-Free(SAC305) solder	IT3M-200P-15BGA(37)	636-0505-6 37	41.5	
	Sn-Pb solder	IT3M-200P-15BGA(57)	636-0505-6 57		
	Pb-Free(SAC305) solder	IT3M-300P-15BGA(37)	636-0506-9 37	59.0	
	Sn-Pb solder	IT3M-300P-15BGA(57)	636-0506-9 57		

◆PCB footprint (mounting foot pattern)

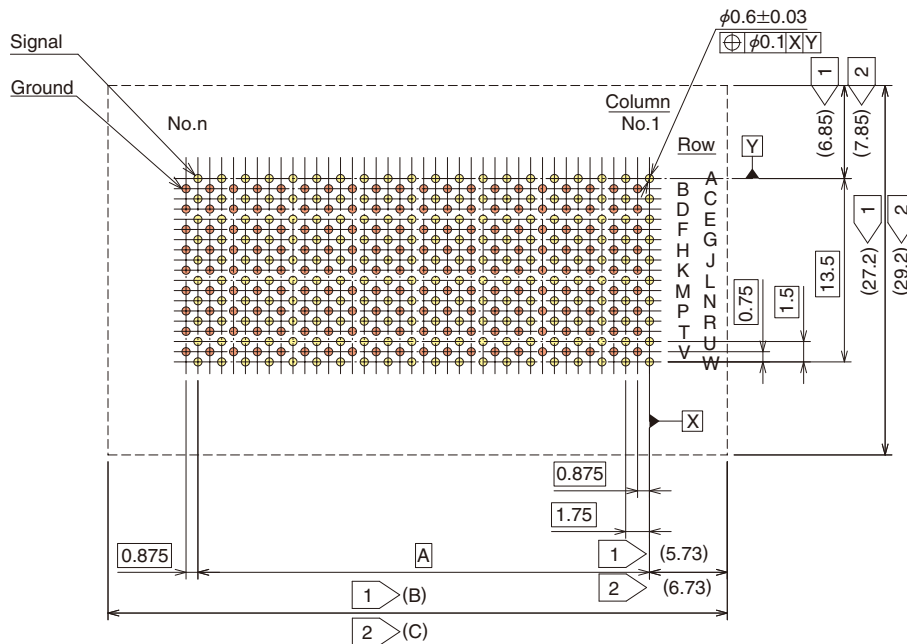

Mounting Receptacle - IT3M Plug

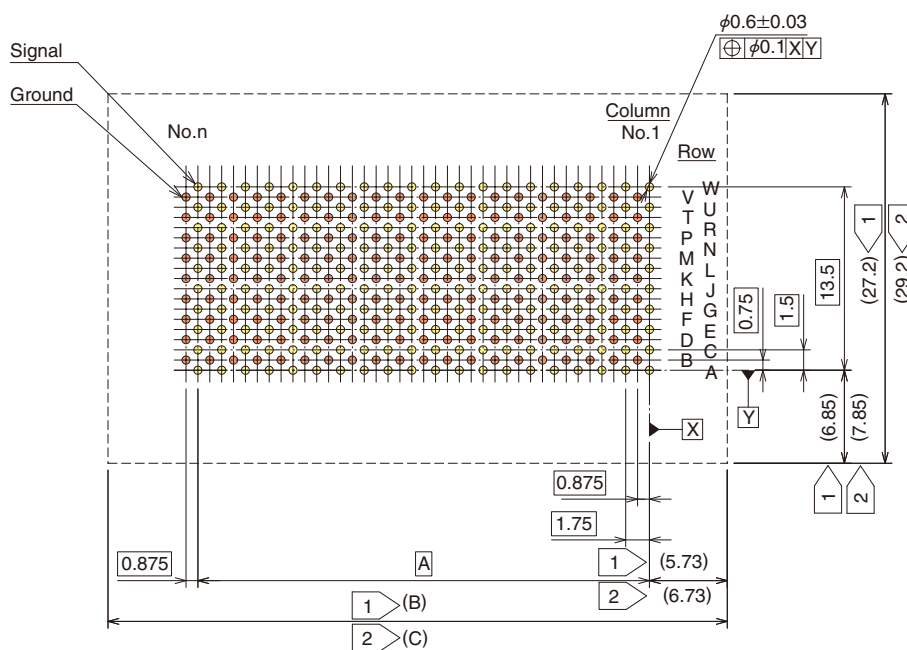

Mating Receptacle - IT3D

- 1 Minimum clearance for all devices
- 2 Minimum clearance for sensitive devices

*Unit : mm

Dimension	100	200	300
A	15.75	33.25	50.75
B	28.10	45.60	63.10
C	30.10	47.60	65.10

Spacers

Spacers are required to support the PWB's and protect the BGA solder joints.

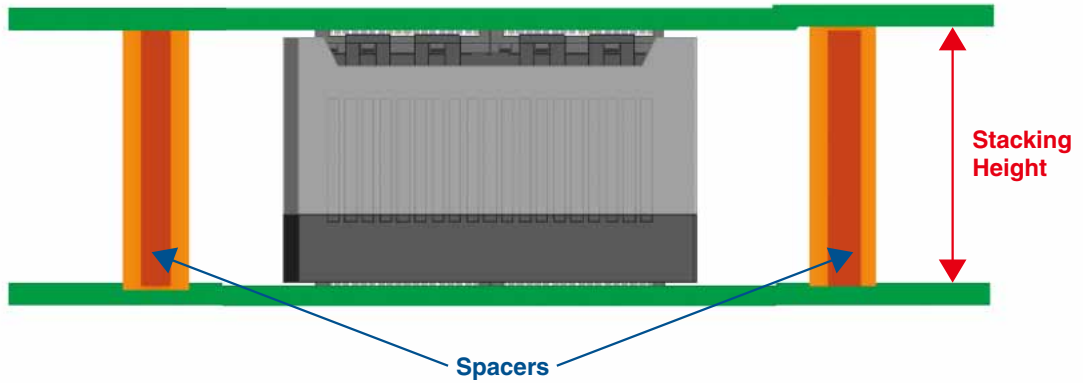

Suggested spacer style is shown below :



Spacer, male-male, M3 thread

The recommended spacer height corresponds to the interposer stacking height as shown in the chart below :

Stacking Height	Recommended Spacer Height
14 mm	14 +/-0.127 mm
15 mm	15 +/-0.127 mm
17 mm	17 +/-0.127 mm
18 mm	18 +/-0.127 mm
20 mm	20 +/-0.127 mm
22 mm	22 +/-0.127 mm
25 mm	25 +/-0.127 mm
26 mm	26 +/-0.127 mm
28 mm	28 +/-0.127 mm
30 mm	30 +/-0.127 mm
32 mm	32 +/-0.127 mm
35 mm	35 +/-0.127 mm
38 mm	38 +/-0.127 mm
40 mm	40 +/-0.127 mm

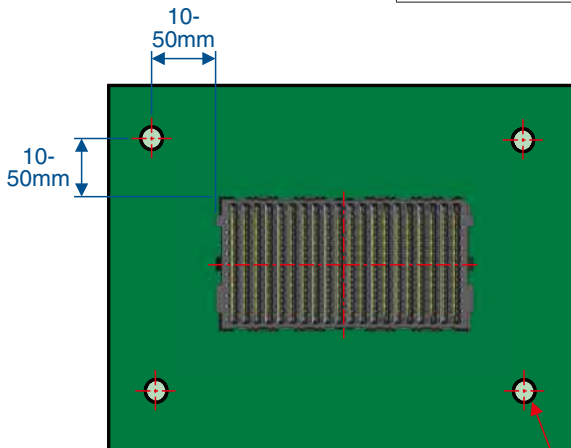

Recommended Spacer Location

$\phi 3.5$
Non plated through hole

Two spacers located diagonally are minimally required. Some applications may require 4 spacers. Spacers should be located 10 – 50 mm from the corners of the receptacles to prevent excessive mechanical loading on the interconnections. If assembly will be subjected to vibration, spacers should be located to prevent resonance, and additional spacers may be required.

◆ Interposer installation

Position interposer directly over mounting receptacle, aligning the polarity chamfers. If positioned properly, the interposer should slide easily onto the mounting receptacle. Place installation cap onto interposer and push straight down to engage the locking latches.

Manual Installation

*Installation caps are available upon request for manual operation

Press firmly on installation cap only, not on wafers or interposer body

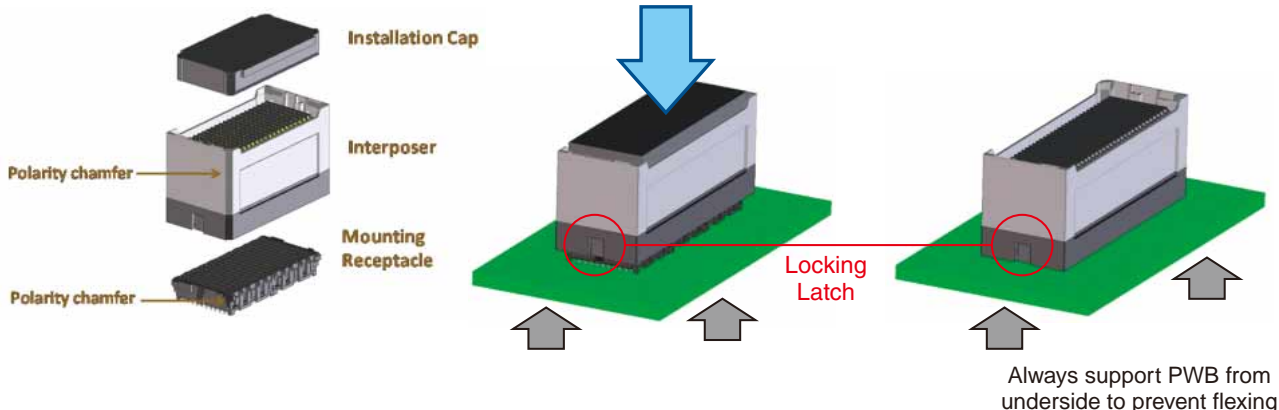

◆ Daughter card installation

After the interposer is mounted, install spacers onto motherboard. To install mating receptacle, align the spacer holes in the daughter card with the threads on the spacers.

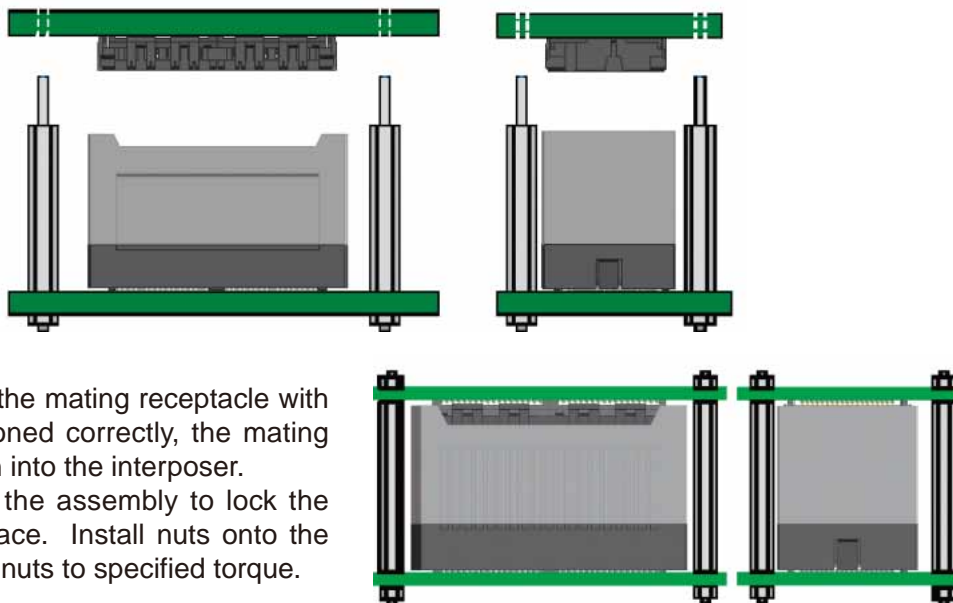

The spacers help align the mating receptacle with the interposer. If positioned correctly, the mating receptacle will slip down into the interposer. Push directly down on the assembly to lock the mating receptacle in place. Install nuts onto the spacer threads. Tighten nuts to specified torque.

◆ Daughter card removal

To remove a daughter card, first remove the nuts from the reinforcing spacers, then lift the daughter card straight off the interposers, as shown right.

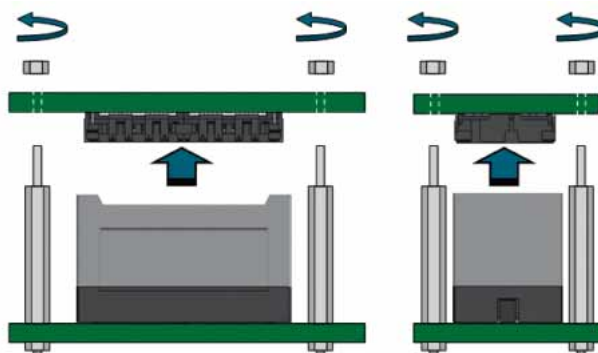

◆ Interposer removal

Interposer Removal by Hand

- 1) Hold the Interposer Assembly on the walls without locking latches



- 2) Gently rotate one side of the Interposer Assembly laterally 10° maximum



Caution: do not rotate more than 10 degrees

- 3) While gently rotating, pull up on other side of the Interposer Assembly

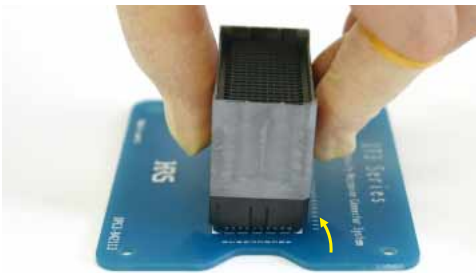

- 4) The Interposer Assembly is removed, and the Mounting Receptacle is ready to accept another Interposer Assembly.

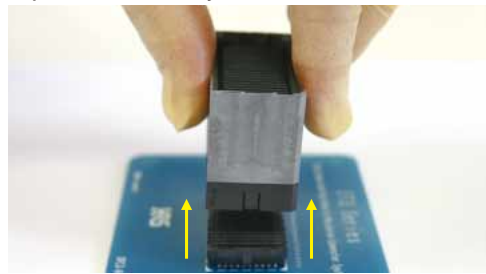

An interposer removal tool is also available. This tool is not an interposer installation cap, so please do not use it to install an interposer. Doing so may damage an interposer.

Interposer Removal with Tool

- 1) Cover the interposer Assembly with the interposer removal tool

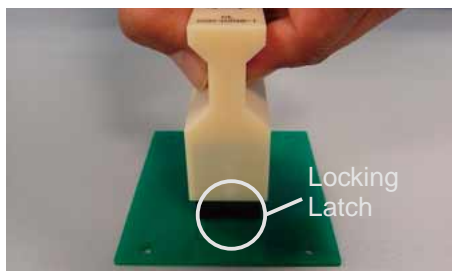

- 2) Gently rotate one side of the Interposer Assembly laterally 10° maximum using the tool

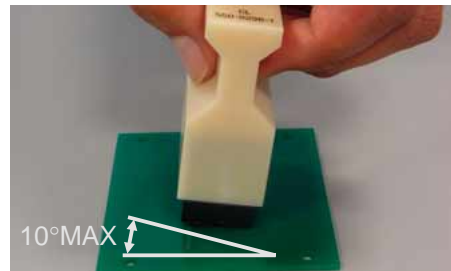

Caution: do not rotate more than 10 degrees

- 3) While gently rotating, pull up on other side of the tool

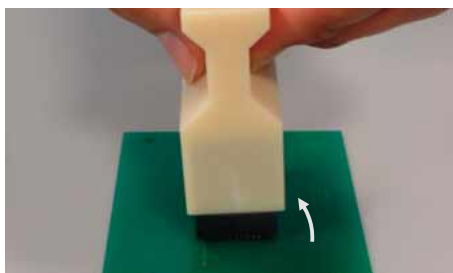

- 4) The Interposer Assembly is removed, as it is inside the tool

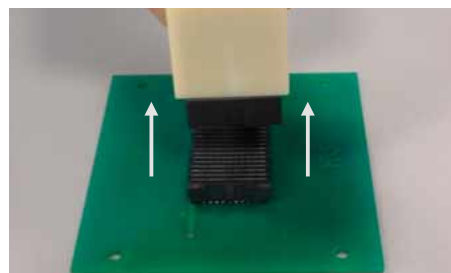

Precaution

Visually inspect the interposer before reinstalling it. Discard if it shows any sign of damage or wear. Do not subject the interposer assembly to more than five removal-reinstallation cycles, even if it appears unaffected.

◆ Assembly reflow soldering profile

Parameters	Eutectic (SnPb)	Pb-Free	Comment
Preheat Ramp Rate	2 - 3°C/sec	2 - 3°C/sec	Other components may limit ramp rate to 2°C/sec
Soak Time	0 - 120 sec	0 - 120 sec	Soak requirements determined by board design, oven capability, and paste activation requirements
Soak Temperature	140 - 180°C	160 - 215°C	Caution - "oversoaking" may exhaust flux and affect soldering
Peak Reflow Temperature	205 - 225°C	230 - 250°C	Cooler peak temperatures may require longer TAL's
Time Above Liquidus (TAL)	30 - 90 sec	45 - 120 sec	Shorter TAL's may require higher peak temperatures
Cooling Rate	>6°C/sec	>6°C/sec	Faster cooling rates produce finer grain structures and smoother joint appearances
Maximum Package Body Temperature (T)	240°C	260°C	Open body design allows for low delta T between package and solder joint
Maximum Delta T between Body and PWB at Liquidus	10°C	10°C	Standard practice is easy to achieve with open body design
Package Body Exposure Limit at Maximum Temperature	5 sec	5 sec	Adjust profile if maximum exposure limit is approached or exceeded

Reflow Profile

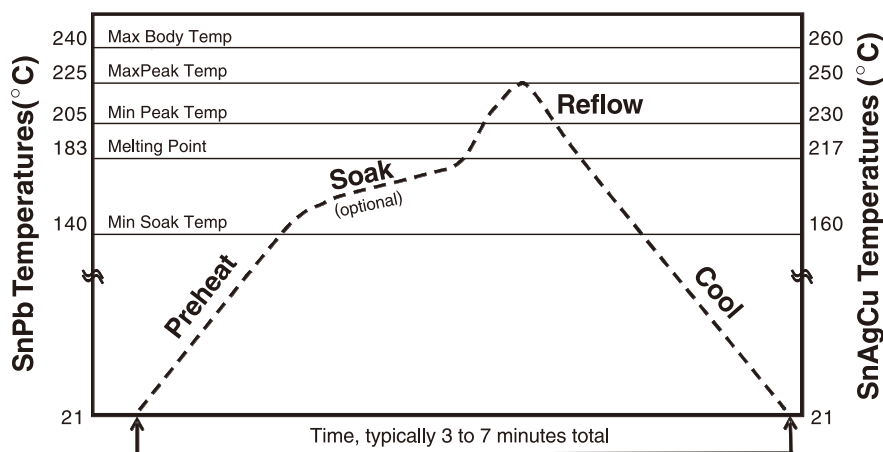

Different solder pastes have different thermal performance characteristics. Consult with paste manufacturer for optimum profile settings. Check thermal exposure limits of PWB laminate if processing with Pb-free solder.

◆ Mating self alignment

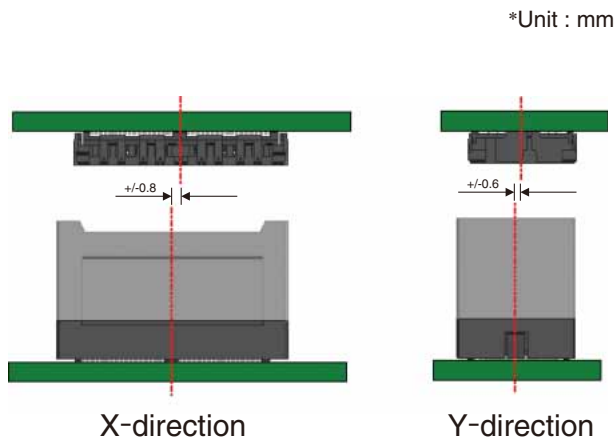

◆ Mating tolerance

Due to its 3-piece design, the IT3 connector system can accept mating tolerances of up to ±0.3mm tolerance in the X-axis and up to ±0.2mm in the Y-axis.

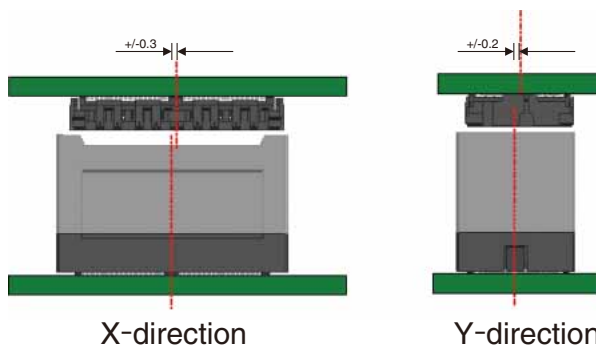

◆ Packaging information

Please order per box with its Minimum Order Quantity (MOQ) of connectors contained. The number for each configuration is shown below.

● Receptacles

IT 3* - ***S - BGA(**)
 (1) (2)

Unit : pcs

(1) \ (2)	100	200	300
M	120	72	48
D	120	72	48

● Plug

IT 3* - ***P - BGA(**)
 (1) (2)

This is also a packaging quantity, therefore please multiply integrally based on this MOQ quantity when you place more.

Ex.) 240pcs of IT3M-300S-BGA(57)
 (= 5 of vacuum packed boxes)

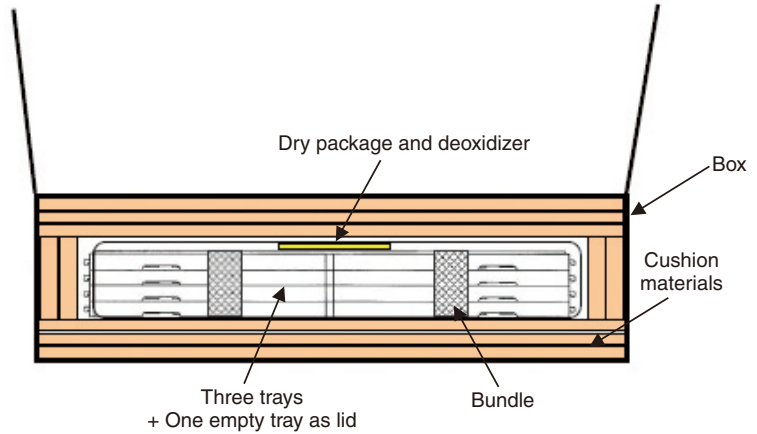

◆ Packaging information

● Interposers

IT 3 - ***P - ***H(**)
 (3) (4)

Unit : pcs

(3) \ (4)	100	200	300
17	100	80	60
18	100	80	60
20	100	80	60
22	100	80	60
25	100	80	60
26	100	80	60
28	50	40	30
30	—	40	30
32	50	40	30
35	50	40	30
38	50	40	30
40	50	—	30

This is also a packaging quantity, therefore please multiply integrally based on this MOQ quantity when you place more.

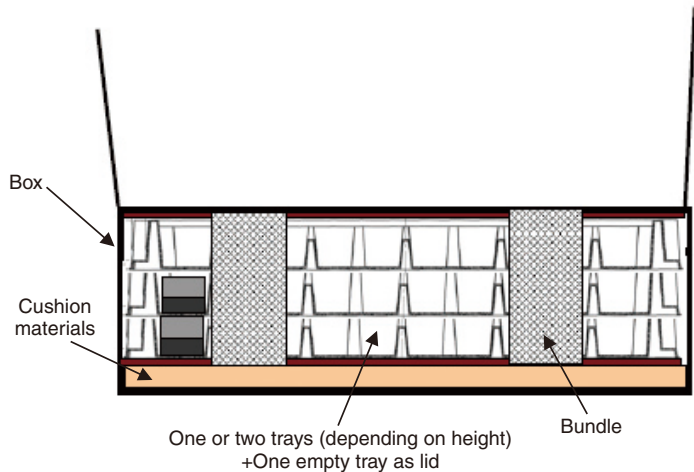

◆ Tray information

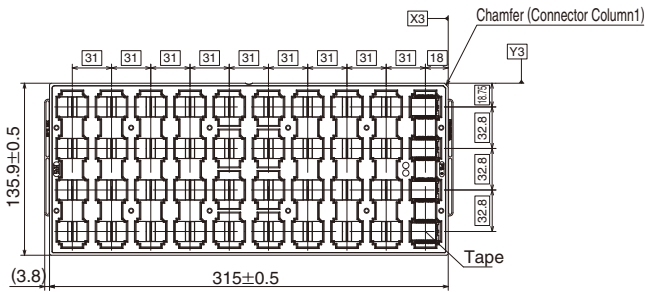

JEDEC Tray for IT3M 100 Position Receptacles and plug

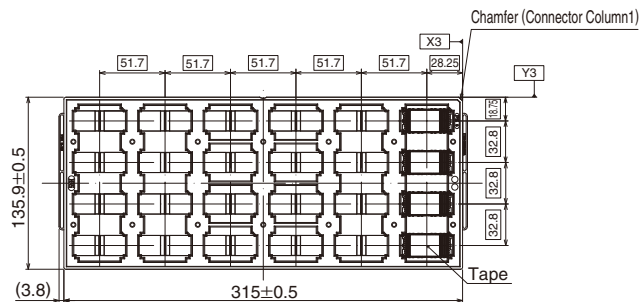

JEDEC Tray for IT3M 200 Position Receptacles and plug

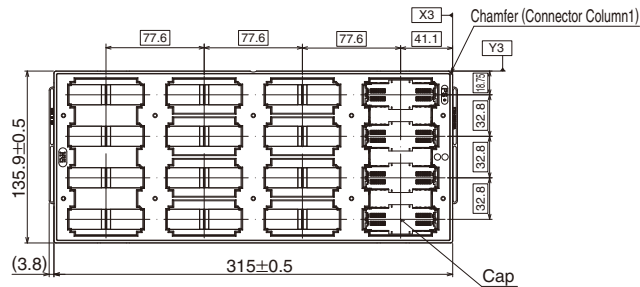

JEDEC Tray for IT3M 300 Position Receptacles and plug

◆ Tray information (con't)

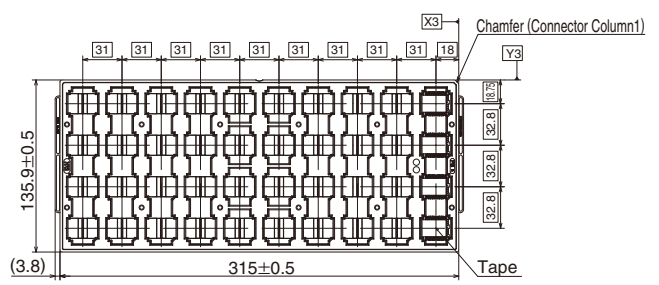

JEDEC Tray for IT3D 100 Position Receptacles

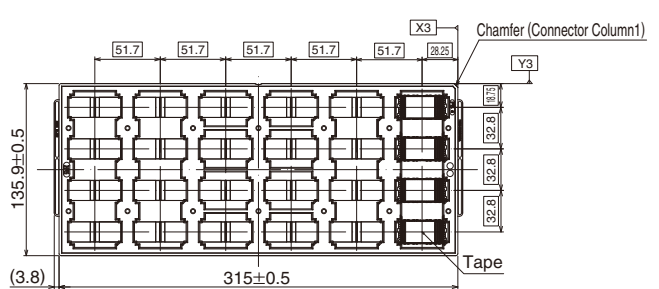

JEDEC Tray for IT3D 200 Position Receptacles

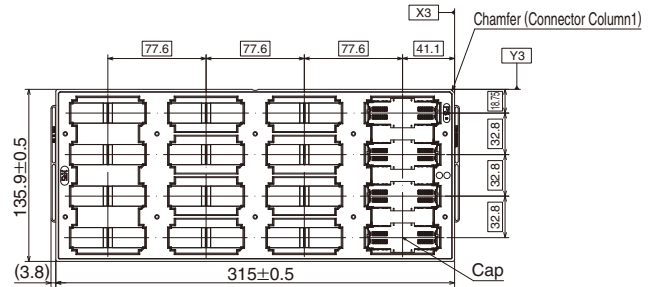

JEDEC Tray for IT3D 300 Position Receptacles

USA:

HIROSE ELECTRIC (U.S.A.), INC. HEADQUARTERS CHICAGO OFFICE
2300 Warrenville Road, Suite 150,
Downers Grove, IL 60515
Phone : +1-630-282-6700
<http://www.hirose.com/us/>

USA:

HIROSE ELECTRIC (U.S.A.), INC. BOSTON OFFICE
300 Brickstone Square Suite 201,
Andover, MA 01810
Phone : +1-978-662-5255

GERMANY:

HIROSE ELECTRIC EUROPE B.V. NUREMBERG OFFICE
Neumeyerstrasse 22-26, 90411 Nurnberg
Phone : +49-911 32 68 89 63
Fax : +49-911 32 68 89 69
<http://www.hirose.com/eu/>

UNITED KINGDOM:

HIROSE ELECTRIC EUROPE BV (UK BRANCH)
4 Newton Court, Kelvin Drive, Knowlhill,
Milton Keynes, MK5 8NH
Phone : +44-1908 202050
Fax : +44-1908 202058
<http://www.hirose.com/eu/>

CHINA:

HIROSE ELECTRIC TECHNOLOGIES (SHENZHEN) CO., LTD.
Room 09-13, 19/F, Office Tower Shun Hing Square, Di Wang Commercial Centre,
5002 Shen Nan Dong Road, Shenzhen City, Guangdong Province, 518008
Phone : +86-755-8207-0851
Fax : +86-755-8207-0873
<http://www.hirose.com/cn/>

KOREA:

HIROSE KOREA CO.,LTD.
143, Gongdan 1-daero, Siheung-si,
Gyeonggi-do, 15084, Korea
Phone : +82-31-496-7000
Fax : +82-31-496-7100
<http://www.hirose.co.kr/>

INDIA:

HIROSE ELECTRIC SINGAPORE PTE. LTD. BANGALORE LIAISON OFFICE
Unit No-403, 4th Floor, No-84, Barton Centre, Mahatma
Gandhi (MG) Road, Bangalore 560 001, Karnataka, India
Phone : +91-80-4120 1907
Fax : +91-80-4120 9908
<http://www.hirose.com/sg/>

USA:

HIROSE ELECTRIC (U.S.A.), INC. SAN JOSE OFFICE
2841 Junction Ave, Suite 200
San Jose, CA. 95134
Phone : +1-408-253-9640
Fax : +1-408-253-9641
<http://www.hirose.com/us/>

THE NETHERLANDS:

HIROSE ELECTRIC EUROPE B.V.
Hogehillweg #8 1101 CC Amsterdam Z-0
Phone : +31-20-6557460
Fax : +31-20-6557469
<http://www.hirose.com/eu/>

GERMANY:

HIROSE ELECTRIC EUROPE B.V. HANOVER OFFICE
Bayernstr. 3, Haus C 30855 Langenhagen, Germany
Phone : +49-511 97 82 61 30
Fax : +49-511 97 82 61 35
<http://www.hirose.com/eu/>

CHINA:

HIROSE ELECTRIC (SHANGHAI) CO., LTD.
18, Enterprise Center Tower 2, 209# Gong He
Road, Jing'an District, Shanghai, CHINA 200070
Phone : +86-21-6391-3355
Fax : +86-21-6391-3335
<http://www.hirose.com/cn/>

HONG KONG:

HIROSE ELECTRIC HONGKONG TRADING CO., LTD.
Room 1001, West Wing, Tsim Sha Tsui Centre, 66
Mody Road, Tsim Sha Tsui East, Kowloon, Hong Kong
Phone : +852-2803-5338
Fax : +852-2591-6560
<http://www.hirose.com/hk/>

SINGAPORE:

HIROSE ELECTRIC SINGAPORE PTE. LTD.
03, Anson Road, #20-01, Springleaf Tower,
Singapore 079909
Phone : +65-6324-6113
Fax : +65-6324-6123
<http://www.hirose.com/sg/>

MALAYSIA:

PENANG REPRESENTATIVE OFFICE
73-3-1, Ideal@The One, Jalan Mahsuri, Bayan
Lepas Penang, 11950, Malaysia
Phone : +604-648-5536
<http://www.hirose.com/sg/>

USA:

HIROSE ELECTRIC (U.S.A.), INC. DETROIT OFFICE (AUTOMOTIVE)
17197 N. Laurel Park Drive, Suite 253,
Livonia, MI 48152
Phone : +1-734-542-9963
Fax : +1-734-542-9964
<http://www.hirose.com/us/>

GERMANY:

HIROSE ELECTRIC EUROPE B.V. GERMAN BRANCH
Schoenbergstr. 20, 73760 ostfildern
Phone : +49-711-456002-1
Fax : +49-711-456002-299
<http://www.hirose.com/eu/>

FRANCE:

HIROSE ELECTRIC EUROPE B.V. PARIS OFFICE
130 Avenue Joseph Kessel, Bat E, 78960
Voisins le Bretonneux, France
Phone : +33-1-85764886
Fax : +33-1-85764823
<http://www.hirose.com/eu/>

CHINA:

HIROSE ELECTRIC (SHANGHAI) CO.,LTD. BEIJING BRANCH
A1001, Ocean International Center, Building 56# East 4th
Ring Middle Road, ChaoYang District, Beijing, 100025
Phone : +86-10-5165-9332
Fax : +86-10-5908-1381
<http://www.hirose.com/cn/>

TAIWAN:

HIROSE ELECTRIC TAIWAN CO., LTD.
103 8F, No.87, Zhengzhou Rd., Taipei
Phone : +886-2-2555-7377
Fax : +886-2-2555-7355
<http://www.hirose.com/tw/>

INDIA:

HIROSE ELECTRIC SINGAPORE PTE. LTD. DELHI LIAISON OFFICE
Office NO.552, Regus-Green Boulevard, Level5, Tower C,
Sec62, Plot B-9A, Block B, Noida, 201301, Uttar Pradesh, India
Phone : +91-12-660-8018
Fax : +91-120-4804949
<http://www.hirose.com/sg/>

THAILAND:

BANGKOK OFFICE (REPRESENTATIVE OFFICE)
Unit 4703, 47th FL., 1 Empire Tower, South Sathorn
Road, Yannawa, Sathorn, Bangkok 10120 Thailand
Phone : +66-2-686-1255
Fax : +66-2-686-3433
<http://www.hirose.com/sg/>

**HIROSE ELECTRIC CO.,LTD.**

2-6-3,Nakagawa Chuoh,Tsuzuki-Ku,Yokohama-Shi 224-8540,JAPAN
TEL: +81-45-620-3526 Fax: +81-45-591-3726
<http://www.hirose.com>
<http://www.hirose-connectors.com>