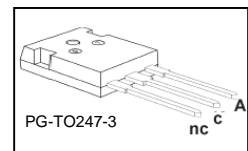
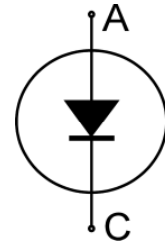


## Fast Switching Emitter Controlled Diode


**Features:**

- 600V Emitter Controlled technology
- Fast recovery
- Soft switching
- Low reverse recovery charge
- Low forward voltage
- 175°C junction operating temperature
- Easy paralleling
- Pb-free lead plating; RoHS compliant
- Complete product spectrum and PSpice Models:  
<http://www.infineon.com>


**Applications:**

- Welding
- Motor drives

Type	$V_{RRM}$	$I_F$	$V_{F,T_j=25^\circ C}$	$T_{j,max}$	Marking	Package
IDW100E60	600V	100A	1.65V	175°C	D100E60	PG-TO247-3

**Maximum Ratings**

Parameter	Symbol	Value	Unit
Repetitive peak reverse voltage	$V_{RRM}$	600	V
Continuous forward current	$I_F$	150	A
$T_C = 25^\circ C$		104	
$T_C = 90^\circ C$		96	
Surge non repetitive forward current	$I_{FSM}$	400	A
$T_C = 25^\circ C, t_p = 10 \text{ ms, sine halfwave}$			
Maximum repetitive forward current	$I_{FRM}$	300	A
$T_C = 25^\circ C, t_p \text{ limited by } t_{j,max}, D = 0.5$			
Power dissipation	$P_{tot}$	375	W
$T_C = 25^\circ C$		212	
$T_C = 90^\circ C$		198	
$T_C = 100^\circ C$			
Operating junction temperature	$T_j$	-40...+175	°C
Storage temperature	$T_{stg}$	-55...+150	
Soldering temperature 1.6mm (0.063 in.) from case for 10 s	$T_s$	260	

**Thermal Resistance**

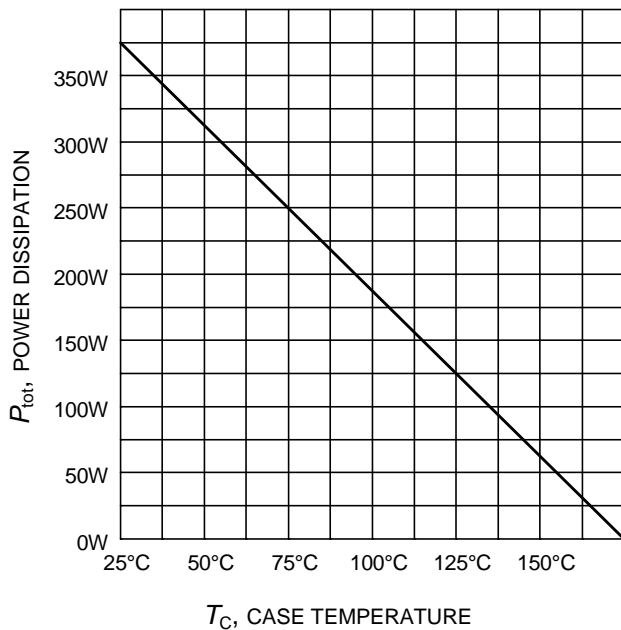
Parameter	Symbol	Conditions	Max. Value	Unit
<b>Characteristic</b>				
Thermal resistance, junction – case	$R_{thJC}$		0.40	K/W
Thermal resistance, junction – ambient	$R_{thJA}$		40	

**Electrical Characteristic, at  $T_j = 25^\circ\text{C}$ , unless otherwise specified**

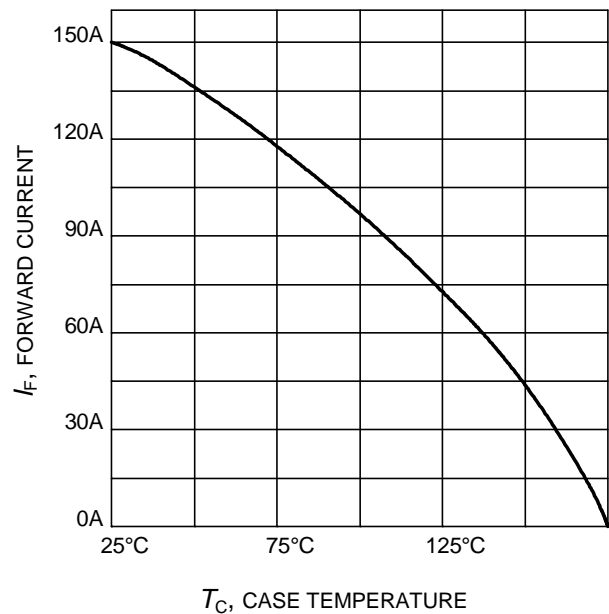
Parameter	Symbol	Conditions	Value			Unit
			min.	typ.	max.	
<b>Static Characteristic</b>						
Collector-emitter breakdown voltage	$V_{RRM}$	$I_R=0.25\text{mA}$	600	-	-	V
Diode forward voltage	$V_F$	$I_F=100\text{A}$ $T_j=25^\circ\text{C}$ $T_j=175^\circ\text{C}$	- -	1.65 1.65	2.0 -	
Reverse leakage current	$I_R$	$V_R=600\text{V}$ $T_j=25^\circ\text{C}$ $T_j=175^\circ\text{C}$	- -	- -	40 3300	$\mu\text{A}$

**Dynamic Electrical Characteristics**

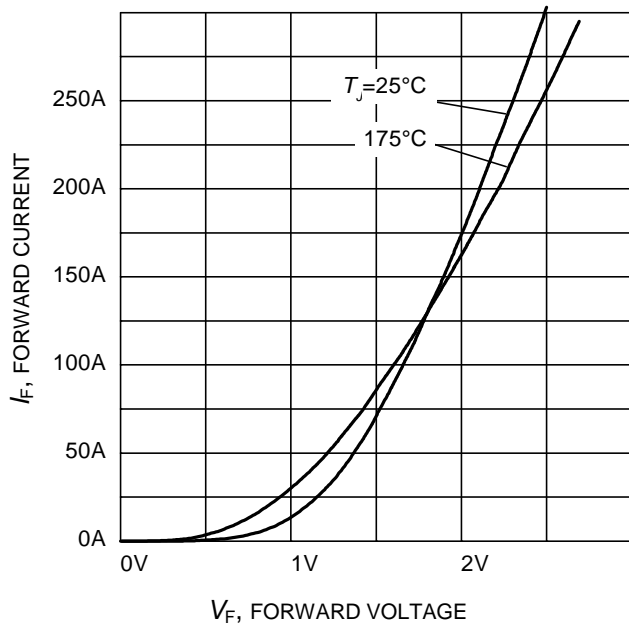
Diode reverse recovery time	$t_{rr}$	$T_j=25^\circ\text{C}$	-	120	-	ns
Diode reverse recovery charge	$Q_{rr}$	$V_R=400\text{V}$ ,	-	3.6	-	$\mu\text{C}$
Diode peak reverse recovery current	$I_{rr}$	$I_F=100\text{A}$ ,	-	49.5	-	A
Diode peak rate of fall of reverse recovery current during $t_b$	$dl_{rr}/dt$	$dl_F/dt=1200\text{A}/\mu\text{s}$	-	750	-	$\text{A}/\mu\text{s}$
<hr/>						
Diode reverse recovery time	$t_{rr}$	$T_j=125^\circ\text{C}$	-	168	-	ns
Diode reverse recovery charge	$Q_{rrm}$	$V_R=400\text{V}$ ,	-	5.8	-	$\mu\text{C}$
Diode peak reverse recovery current	$I_{rr}$	$I_F=100\text{A}$ ,	-	61.6	-	A
Diode peak rate of fall of reverse recovery current during $t_b$	$dl_{rr}/dt$	$dl_F/dt=1200\text{A}/\mu\text{s}$	-	705	-	$\text{A}/\mu\text{s}$
<hr/>						
Diode reverse recovery time	$t_{rr}$	$T_j=175^\circ\text{C}$	-	200	-	ns
Diode reverse recovery charge	$Q_{rrm}$	$V_R=400\text{V}$ ,	-	7.8	-	$\mu\text{C}$
Diode peak reverse recovery current	$I_{rr}$	$I_F=100\text{A}$ ,	-	67.0	-	A
Diode peak rate of fall of reverse recovery current during $t_b$	$dl_{rr}/dt$	$dl_F/dt=1200\text{A}/\mu\text{s}$	-	650	-	$\text{A}/\mu\text{s}$



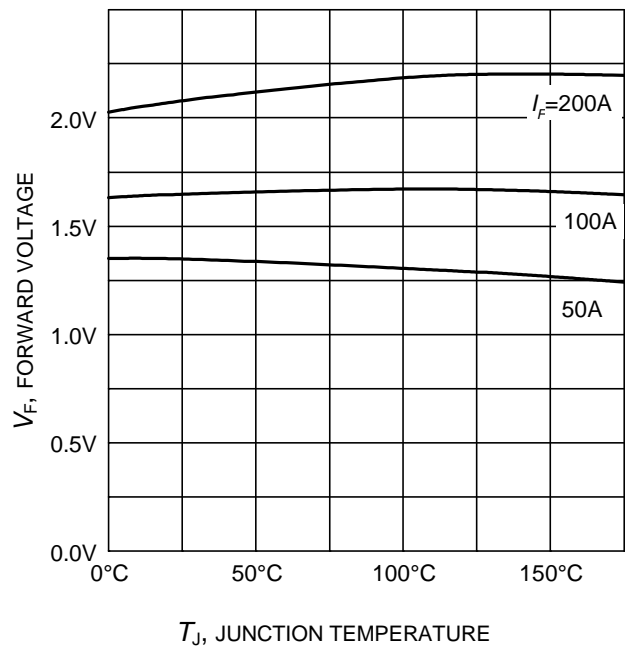
**Figure 1. Power dissipation as a function of case temperature**  
( $T_j \leq 175^\circ\text{C}$ )



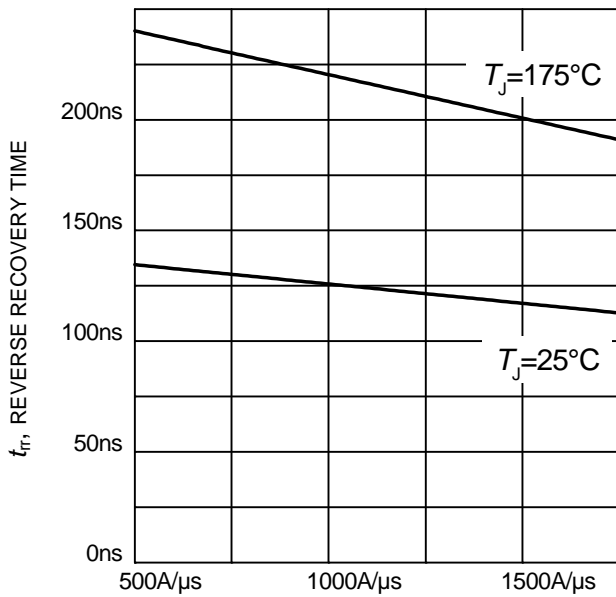
**Figure 2. Diode forward current as a function of case temperature**  
( $T_j \leq 175^\circ\text{C}$ )



**Figure 3. Typical diode forward current as a function of forward voltage**

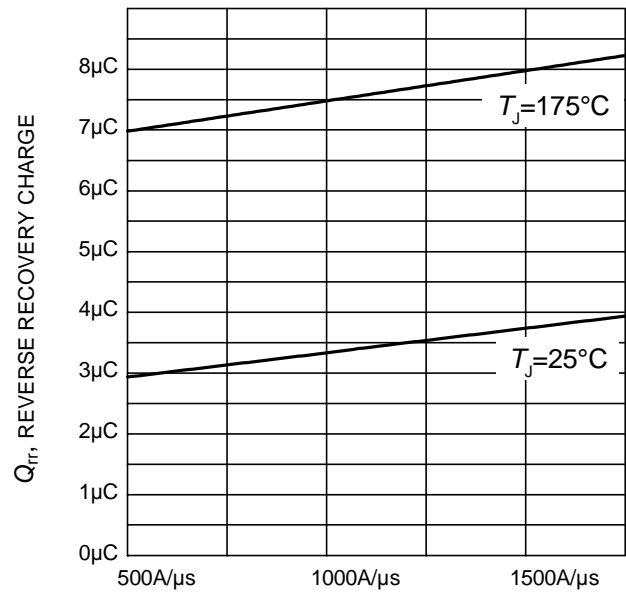


**Figure 4. Typical diode forward voltage as a function of junction temperature**



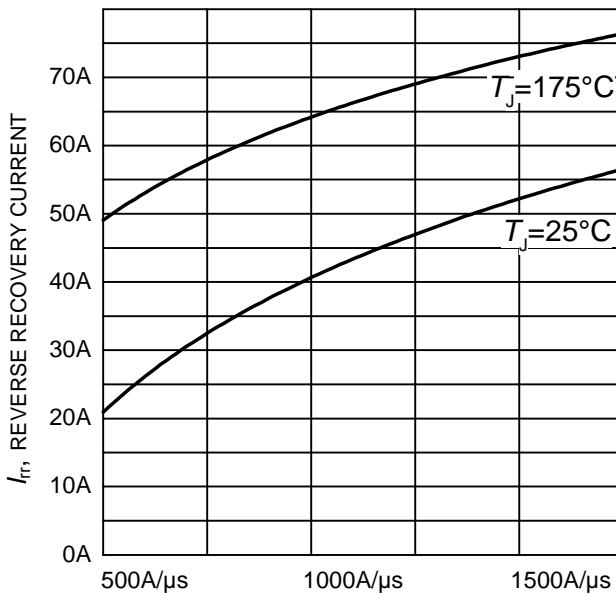
$di_F/dt$ , DIODE CURRENT SLOPE

**Figure 5. Typical reverse recovery time as a function of diode current slope**  
( $V_R=400V$ ,  $I_F=100A$ ,  
Dynamic test circuit in Figure E)



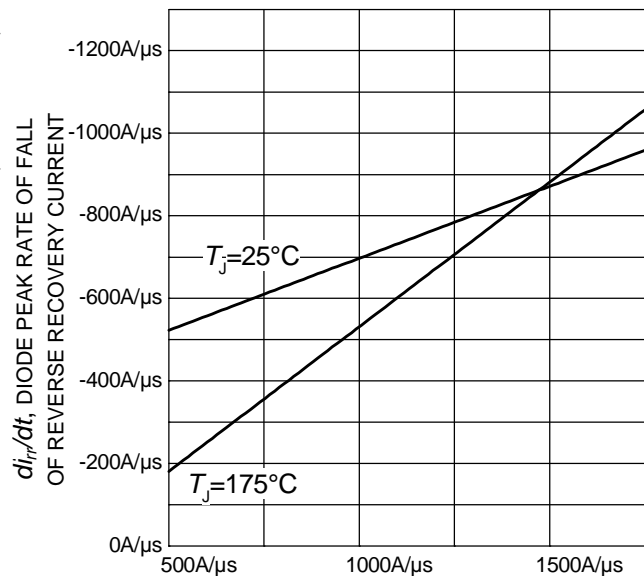
$di_F/dt$ , DIODE CURRENT SLOPE

**Figure 6. Typical reverse recovery charge as a function of diode current slope**  
( $V_R = 400V$ ,  $I_F = 100A$ ,  
Dynamic test circuit in Figure E)



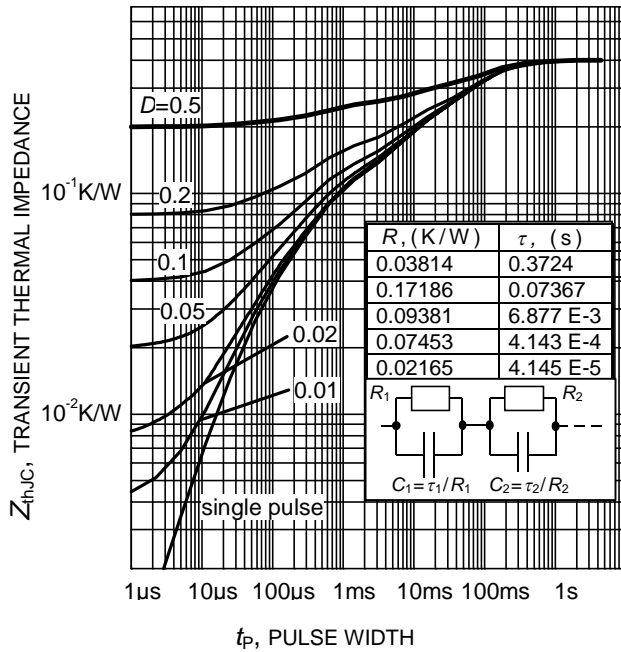
$di_F/dt$ , DIODE CURRENT SLOPE

**Figure 7. Typical reverse recovery current as a function of diode current slope**  
( $V_R = 400V$ ,  $I_F = 100A$ ,  
Dynamic test circuit in Figure E)



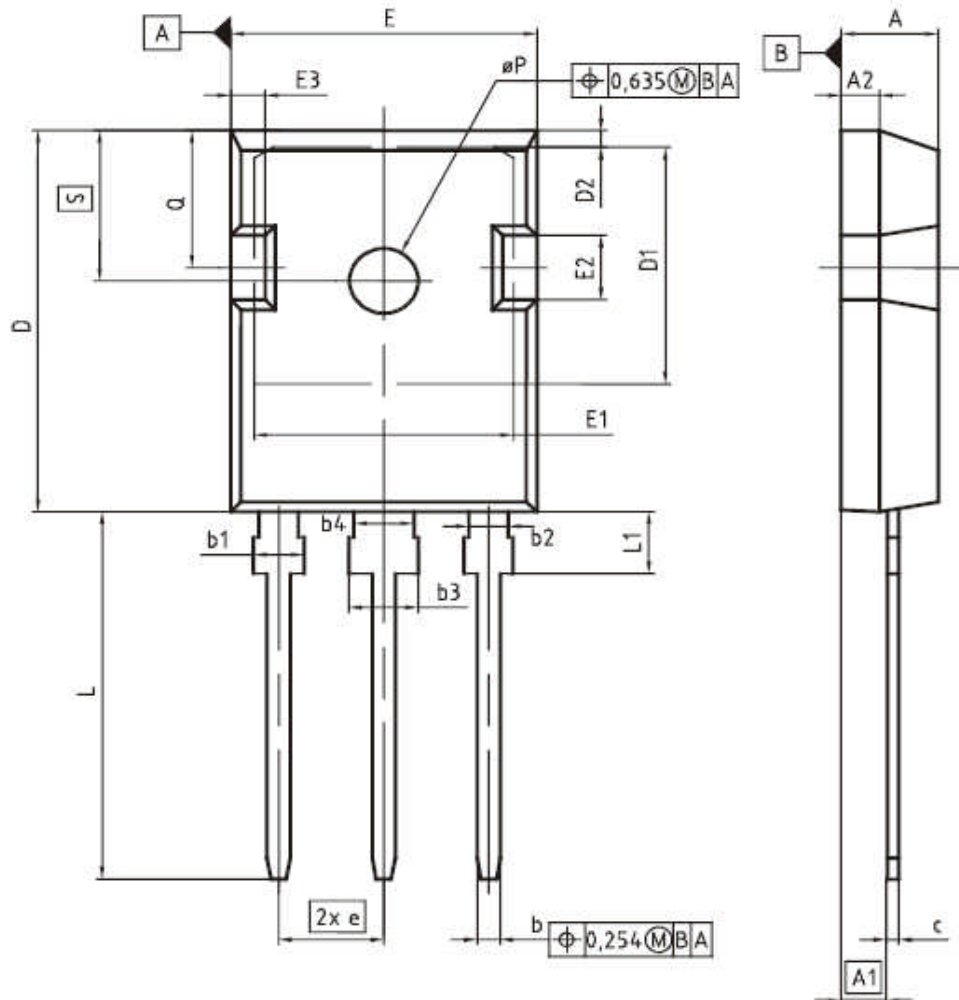
$di_F/dt$ , DIODE CURRENT SLOPE

**Figure 8. Typical diode peak rate of fall of reverse recovery current as a function of diode current slope**  
( $V_R=400V$ ,  $I_F=100A$ ,  
Dynamic test circuit in Figure E)



**Figure 9. Diode transient thermal impedance as a function of pulse width**  
 ( $D=t_p/T$ )

PG-TO247-3



DIM	MILLIMETERS		INCHES	
	MIN	MAX	MIN	MAX
A	4,83	5,21	0,190	0,205
A1	2,27	2,54	0,089	0,100
A2	1,85	2,16	0,073	0,085
b	1,07	1,33	0,042	0,052
b1	1,90	2,41	0,075	0,095
b2	1,90	2,16	0,075	0,085
b3	2,87	3,38	0,113	0,133
b4	2,87	3,13	0,113	0,123
c	0,55	0,68	0,022	0,027
D	20,80	21,10	0,819	0,831
D1	16,25	17,65	0,640	0,695
D2	0,95	1,35	0,037	0,053
E	15,70	16,13	0,618	0,635
E1	13,10	14,15	0,516	0,557
E2	3,68	5,10	0,145	0,201
E3	1,00	2,60	0,039	0,102
e	5,44 (BSC)		0,214 (BSC)	
N	3		3	
L	19,80	20,32	0,780	0,800
L1	4,10	4,47	0,161	0,176
øP	3,50	3,70	0,138	0,146
Q	5,49	6,00	0,216	0,236
S	6,04	6,30	0,238	0,248

DOCUMENT NO.  
Z8B00003327

SCALE

EUROPEAN PROJECTION

ISSUE DATE  
09-07-2010

REVISION  
05

**Published by**  
**Infineon Technologies AG**  
**81726 Munich, Germany**  
**© 2013 Infineon Technologies AG**  
**All Rights Reserved.**

### **Legal Disclaimer**

The information given in this document shall in no event be regarded as a guarantee of conditions or characteristics. With respect to any examples or hints given herein, any typical values stated herein and/or any information regarding the application of the device, Infineon Technologies hereby disclaims any and all warranties and liabilities of any kind, including without limitation, warranties of non-infringement of intellectual property rights of any third party.

### **Information**

For further information on technology, delivery terms and conditions and prices, please contact the nearest Infineon Technologies Office ([www.infineon.com](http://www.infineon.com)).

### **Warnings**

Due to technical requirements, components may contain dangerous substances. For information on the types in question, please contact the nearest Infineon Technologies Office.

The Infineon Technologies component described in this Data Sheet may be used in life-support devices or systems and/or automotive, aviation and aerospace applications or systems only with the express written approval of Infineon Technologies, if a failure of such components can reasonably be expected to cause the failure of that life-support, automotive, aviation and aerospace device or system or to affect the safety or effectiveness of that device or system. Life support devices or systems are intended to be implanted in the human body or to support and/or maintain and sustain and/or protect human life. If they fail, it is reasonable to assume that the health of the user or other persons may be endangered.