

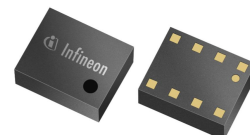
# DPS310 - Digital Pressure Sensor

## Digital Barometric Pressure Sensor for Portable Devices

DPS310 Digital Pressure Sensor

### Product Description

The DPS310 is a miniaturized Digital Barometric Air Pressure Sensor with a high accuracy and a low current consumption, capable of measuring both pressure and temperature. The pressure sensor element is based on a capacitive sensing principle which guarantees high precision during temperature changes. The small package makes the DPS310 ideal for mobile applications and wearable devices.



The internal signal processor converts the output from the pressure and temperature sensor elements to 24 bit results. Each unit is individually calibrated, the calibration coefficients calculated during this process are stored in the calibration registers. The coefficients are used in the application to convert the measurement results to high accuracy pressure and temperature values.

The result FIFO can store up to 32 measurement results, allowing for a reduced host processor polling rate. Sensor measurements and calibration coefficients are available through the serial I<sup>2</sup>C or SPI interface. The measurement status is indicated by status bits or interrupts on the SDO pin.

### Features

- **Operation range:** Pressure: 300 – 1200 hPa. Temperature: -40 – 85 °C.
- **Pressure sensor precision:** ± 0.005 hPa (or ±0.05 m) (high precision mode).
- **Relative accuracy:** ± 0.06 hPa (or ±0.5 m)
- **Absolute accuracy:** ± 1 hPa (or ±8 m)
- **Temperature accuracy:** ± 0.5°C.
- **Pressure temperature sensitivity:** 0.5Pa/K
- **Measurement time: Typical:** 27.6 ms for standard mode (16x). Minimum: 3.6 ms for low precision mode.
- **Average current consumption:** 1.7 µA for Pressure Measurement, 1.5µA for Temperature measurement @1Hz sampling rate, Standby: 0.5 µA.
- **Supply voltage:** VDDIO: 1.2 – 3.6 V, VDD: 1.7 – 3.6 V.
- **Operating modes:** Command (manual), Background (automatic), and Standby.
- **Calibration:** Individually calibrated with coefficients for measurement correction.
- **FIFO:** Stores up to 32 pressure or temperature measurements.
- **Interface:** I<sup>2</sup>C and SPI (both with optional interrupt)
- **Package dimensions:** 8-pin LGA, 2.0 mm x 2.5 mm x 1.0 mm.
- **Green Product (RoHS) Compliant**



### Typical Applications

- **Indoor Navigation** (floor detection e.g. in shopping malls and parking garages)
- **Health and Sports** (accurate elevation gain and vertical speed)
- **Outdoor Navigation** (GPS start-up time and accuracy improvement, dead-reckoning e.g. in tunnels)
- **Weather Station** ('Micro-weather' and local forecasts)
- **HDD drivers**, (leak rate detection in hard disk drives)
- **Drones** (flight stability and height control)

## Table of contents

	<b>Product Description</b> .....	1
	<b>Features</b> .....	1
	<b>Typical Applications</b> .....	1
	<b>Table of contents</b> .....	2
<b>1</b>	<b>Definitions, acronyms and abbreviations</b> .....	4
1.1	Definitions .....	4
<b>2</b>	<b>Pin Configuration and Block Diagram</b> .....	5
2.1	Pin Configuration and Description .....	5
2.2	Block Diagram .....	6
<b>3</b>	<b>Specifications</b> .....	6
3.1	Operating Range .....	6
3.2	Absolute Maximum Ratings .....	7
3.3	Current Consumption .....	7
3.4	Temperature Transfer Function .....	8
3.5	Pressure Transfer Function .....	9
3.6	Timing Characteristics .....	10
<b>4</b>	<b>Functional Description</b> .....	10
4.1	Operating Modes .....	10
4.2	Mode transition diagram .....	10
4.3	Start-up sequence .....	11
4.4	Measurement Precision and Rate .....	11
4.5	Sensor Interface .....	12
4.6	Interrupt .....	12
4.7	Result Register Operation .....	13
4.8	FIFO Operation .....	13
4.9	Calibration and Measurement Compensation .....	13
4.9.1	How to Calculate Compensated Pressure Values .....	14
4.9.2	How to Calculate Compensated Temperature Values .....	14
4.9.3	Compensation Scale Factors .....	15
4.9.4	Pressure and Temperature calculation flow .....	15
<b>5</b>	<b>Applications</b> .....	17
5.1	Measurement Settings and Use Case Examples .....	17
5.2	Application Circuit Example .....	18
5.3	IIR filtering .....	19
<b>6</b>	<b>Digital interfaces</b> .....	19
6.1	I2C Interface .....	20
6.2	SPI Interface .....	20

**Table of contents**

6.3	Interface parameters specification .....	21
6.3.1	General interface parameters .....	22
6.3.1.1	I2C timings .....	22
6.3.1.2	SPI timings .....	24
<b>7</b>	<b>Register Map .....</b>	<b>25</b>
<b>8</b>	<b>Register description .....</b>	<b>25</b>
8.1	Pressure Data (PRS_Bn) .....	25
8.1.1	PRS_B2 .....	26
8.1.2	PRS_B1 .....	26
8.1.3	PRS_B0 .....	27
8.2	Temperature Data (TMP_Tn) .....	27
8.2.1	TMP_B2 .....	27
8.2.2	TMP_B1 .....	28
8.2.3	TMP_B0 .....	28
8.3	Pressure Configuration (PRS_CFG) .....	29
8.4	Temperature Configuration (TMP_CFG) .....	31
8.5	Sensor Operating Mode and Status (MEAS_CFG) .....	32
8.6	Interrupt and FIFO configuration (CFG_REG) .....	33
8.7	Interrupt Status (INT_STS) .....	34
8.8	FIFO Status (FIFO_STS) .....	35
8.9	Soft Reset and FIFO flush (RESET) .....	36
8.10	Product and Revision ID (ID) .....	36
8.11	Calibration Coefficients (COEF) .....	37
8.12	Coefficient Source .....	38
<b>9</b>	<b>Package Dimensions .....</b>	<b>38</b>
<b>10</b>	<b>Package Handling .....</b>	<b>38</b>
	<b>Revision History .....</b>	<b>38</b>
	<b>Known Issues List .....</b>	<b>40</b>
	<b>Trademarks .....</b>	<b>41</b>

**Definitions, acronyms and abbreviations**

**1 Definitions, acronyms and abbreviations**

**1.1 Definitions**

An explanation of terms and definitions used in this datasheet.

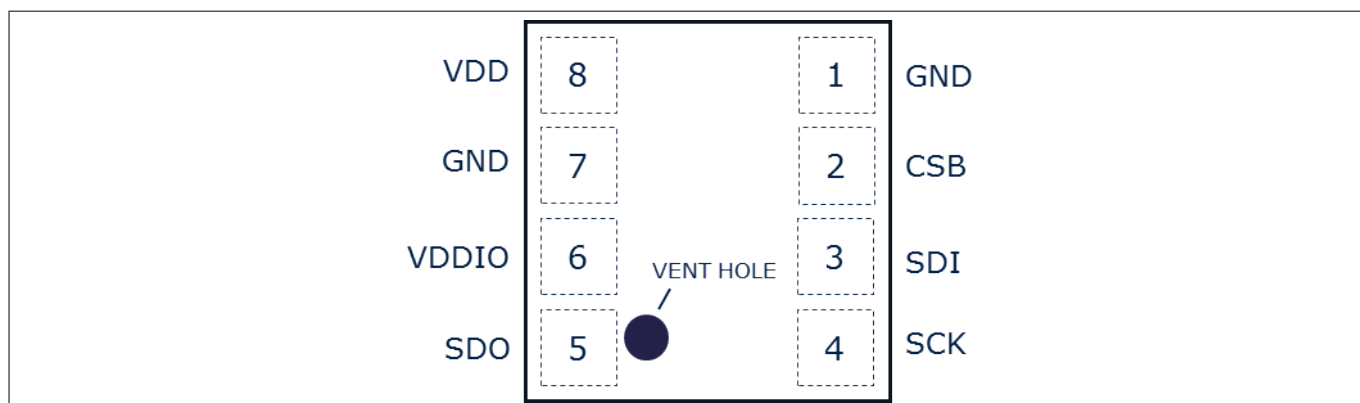
**Table 1**

<b>Term</b>	<b>Definition/explanation</b>
Absolute accuracy	The absolute measurement accuracy over the entire measurement range.
Digital bit depth	The total bit depth used for conversion of the sensor input to the digital output. Measured in bits.
Digital resolution	The pressure value represented by the LSB change in output. This value should be much smaller than the sensor noise.
Full Scale Range (FSR)	The peak-to-peak measurement range of the sensor.
LSB	Least Significant Bit
Measurement time	The time required to acquire one sensor output result. This value determines the maximum <b>measurement rate</b> .
MSB	Most Significant Bit
Non-linearity	The deviation of measured output from the best-fit straight line, relative to 1000 hPa and 25 °C.
Output compensation	The process of applying an algorithm to the sensor output to improve the absolute accuracy of the sensor across temperature and to minimize unit to unit output variation. This algorithm makes use of both the temperature sensor readings and the individual calibration coefficients.
Precision (noise)	The smallest measurable change, expressed as rms, after sensor oversampling.
Pressure temperature coefficient	The pressure measurement deviation, after compensation, from expected measurement value due to temperature change from 25 °C. Measured in Pa/K.
Sensor calibration	The process, during the production test, where the sensor's measurement results are compared against reference values, and a set of calibration coefficients are calculated from the deviation. The coefficients are stored in the sensor's memory and are used in the output compensation.
Sensor oversampling rate (OSR)	Specifies the number of sensor measurements used internally to generate one sensor output result.

**Pin Configuration and Block Diagram**

## 2 Pin Configuration and Block Diagram

### 2.1 Pin Configuration and Description



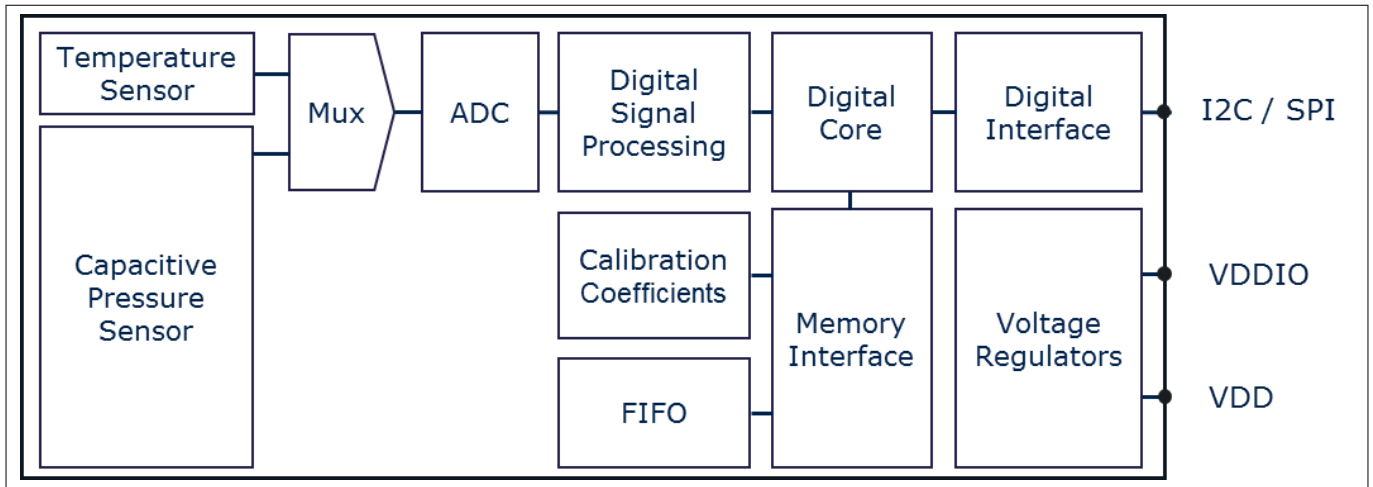
**Figure 1 Pin configuration (top view, figure not to scale)**

**Table 2 Pin description**

Pin	Name	SPI 3-wire	SPI 3-wire with interrupt	SPI 4-wire	I <sup>2</sup> C	I <sup>2</sup> C with interrupt
1	GND	Ground				
2	CSB	Chip select - active low	Chip select - active low	Chip select - active low	Not used - open (internal pull-up) or tie to VDDIO	Not used - open (internal pull-up) or tie to VDDIO
3	SDI	Serial data in/out	Serial data in/out	Serial data in	Serial data in/out	Serial data in/out
4	SCK	Serial Clock				
5	SDO	Not used	Interrupt	Serial data out	Least significant bit in the device address.	Interrupt pin and least significant bit in the device address.
6	VDDIO	Digital supply voltage for digital blocks and I/O interface				
7	GND	Ground				
8	VDD	Supply voltage for analog blocks				

**Specifications**

**2.2 Block Diagram**



**Figure 2**

**3 Specifications**

**3.1 Operating Range**

The following operating conditions must not be exceeded in order to ensure correct operation of the device. All parameters specified in the following sections refer to these operating conditions, unless noted otherwise.

**Table 3 Operating Range**

Parameter	Symbol	Values			Unit	Note / Test Condition
		Min.	Typ.	Max.		
Pressure	$P_a$	300		1200	hPa	
Temperature	$T_a$	-40		85	°C	
Supply voltage	$V_{DD}$	1.7		3.6	V	
Supply voltage IO	$V_{DDIO}$	1.2		3.6	V	
Supply voltage ramp-up time	$t_{vddup}$	0.001		5	ms	Time for supply voltage to reach 90% of final value.
Solder drift <sup>1)</sup>			0.8		hPa	Minimum solder height 50um.
Long term stability			±1		hPa	Depending on environmental conditions.

<sup>1</sup> Effects of solder drift can be eliminated by one point calibration. See AN487.

**Specifications**

**3.2 Absolute Maximum Ratings**

Maximum ratings are absolute ratings. Exceeding any one of these values may cause irreversible damage to the integrated circuit.

**Attention:** *Stresses above the values listed as "Absolute Maximum Ratings" may cause permanent damage to the devices. Exposure to absolute maximum rating conditions for extended periods may affect device reliability.*

**Table 4 Absolute Maximum Ratings**

Parameter	Symbol	Values			Unit	Note / Test Condition
		Min.	Typ.	Max.		
V <sub>DD</sub> and V <sub>DDIO</sub>	V <sub>DDxx_max</sub>			4	V	
Voltage on any pin	V <sub>max</sub>			4	V	
Storage temperature	T <sub>s</sub>	-40		125	°C	
Pressure	P <sub>max</sub>			10,000	hPa	
ESD	V <sub>ESD_HBM</sub>	-2		2	KV	HBM (JS001)

**3.3 Current Consumption**

Test conditions (unless otherwise specified in the table): V<sub>DD</sub>= 1.8V and V<sub>DDIO</sub>=1.8V. Typ. values (P<sub>A</sub>=1000hPa and T<sub>A</sub>=25°C). Max./Min. values (P<sub>A</sub>= 950-1050hPa and T<sub>A</sub>=0...+65°C).

**Table 5 Current Consumption**

Parameter	Symbol	Values			Unit	Note / Test Condition
		Min.	Typ.	Max.		
Peak Current Consumption	I <sub>peak</sub>		345		μA	during Pressure measurement
			280		μA	during Temperature measurement
Standby Current Consumption	I <sub>stb</sub>		0.5		μA	
Current Consumption. (1 measurement per second.)	I <sub>1Hz</sub>		2.1		μA	Low precision
			11			Standard precision
			38			High precision

*Note: The current consumption depends on both pressure measurement precision and rate. Please refer to the **Pressure Configuration (PRS\_CFG)** register description for an overview of the current consumption in different combinations of measurement precision and rate.*

**Specifications**

**3.4 Temperature Transfer Function**

Test conditions (unless otherwise specified in the table):  $V_{DD}=1.8V$  and  $V_{DDIO}=1.8V$ . Typ. values ( $P_A=1000hPa$  and  $T_A=25^\circ C$ ). Max./Min. values ( $P_A=950-1050hPa$  and  $T_A=0\dots+65^\circ C$ ).

**Table 6 Temperature Transfer Function**

Parameter	Symbol	Values			Unit	Note / Test Condition
		Min.	Typ.	Max.		
Temperature accuracy	$A_t$		+/-0.5		$^\circ C$	
Temperature data resolution	$A_{t\_res}$		0.01		$^\circ C$	
Temperature measurement rate	f	1		128	Hz	



**Specifications**

**3.5 Pressure Transfer Function**

Test conditions (unless otherwise specified in the table):  $V_{DD}=1.8V$  and  $V_{DDIO}=1.8V$ . Typ. values ( $P_A=1000hPa$  and  $T_A=25^\circ C$ ).

**Table 7 Pressure Transfer Function**

Parameter	Symbol	Values			Unit	Note / Test Condition
		Min.	Typ.	Max.		
Absolute pressure accuracy	$A_{p\_abs}$		+/-10		Pa	After one point calibration
			+/-100		Pa	$P_A=300-1200hPa$ $T_A=0...+65^\circ C$ Excluding solder effects
Relative pressure accuracy	$A_{p\_rel}$		+/-6		Pa	Any $\Delta 1hPa$ in the range $P_A=800-1200hPa$ Any constant temperature in the range $T_A=20...+60^\circ C$
Pressure precision	$A_{p\_prc}$		5.0		$Pa_{RMS}$	Low Power
			1.2			Standard
			0.5			High Precision

Note: *Pressure precision is measured as the average standard deviation. Please refer to the [Pressure Configuration \(PRS\\_CFG\)](#) register description for all precision mode options.*

Power supply rejection	$A_{p\_psr}$			0.063	$Pa_{RMS}$	Measured with 217Hz square wave and broad band noise, $100mV_{pp}$
Pressure temperature sensitivity of calibrated measurements	$A_{p\_tmp}$		0.5		Pa/K	$1000hPa, 25...+65^\circ C$ .
Pressure data resolution	$A_{p\_res}$			0.06	$Pa_{RMS}$	
Pressure measurement rate	f	1		128	Hz	
Pressure measurement time	t		5.2		ms	Low Power
			27.6			Standard
			105			High Precision

Note: *The pressure measurement time (and thus the maximum rate) depends on the pressure measurement precision. Please refer to the [Pressure Configuration \(PRS\\_CFG\)](#) register description for an overview of the possible combinations of measurement precision and rate.*

**Functional Description**

**3.6 Timing Characteristics**

**Table 8 Timing Characteristics**

Parameter	Symbol	Values			Unit	Note / Test Condition
		Min.	Typ.	Max.		
Start-up timing						
Time to sensor ready	T <sub>Sensor_rdy</sub>			12	ms	The SENSOR_RDY bit in the Measurement Configuration register will be set when the sensor is ready.
Time to coefficients are available.	T <sub>Coef_rdy</sub>			40	ms	The COEF_RDY bit in the Measurement Configuration register will be set when the coefficients can be read out.

Note: Start-up timing is measured from VDD > 1.2V & VDDIO > 0.6V or Soft Reset.

I <sup>2</sup> C Clock.	f <sub>I2C</sub>			3.4	MHz	
SPI Clock	f <sub>SPI</sub>			10	MHz	

**4 Functional Description**

**4.1 Operating Modes**

The DPS310 supports 3 different modes of operation: Standby, Command, and Background mode.

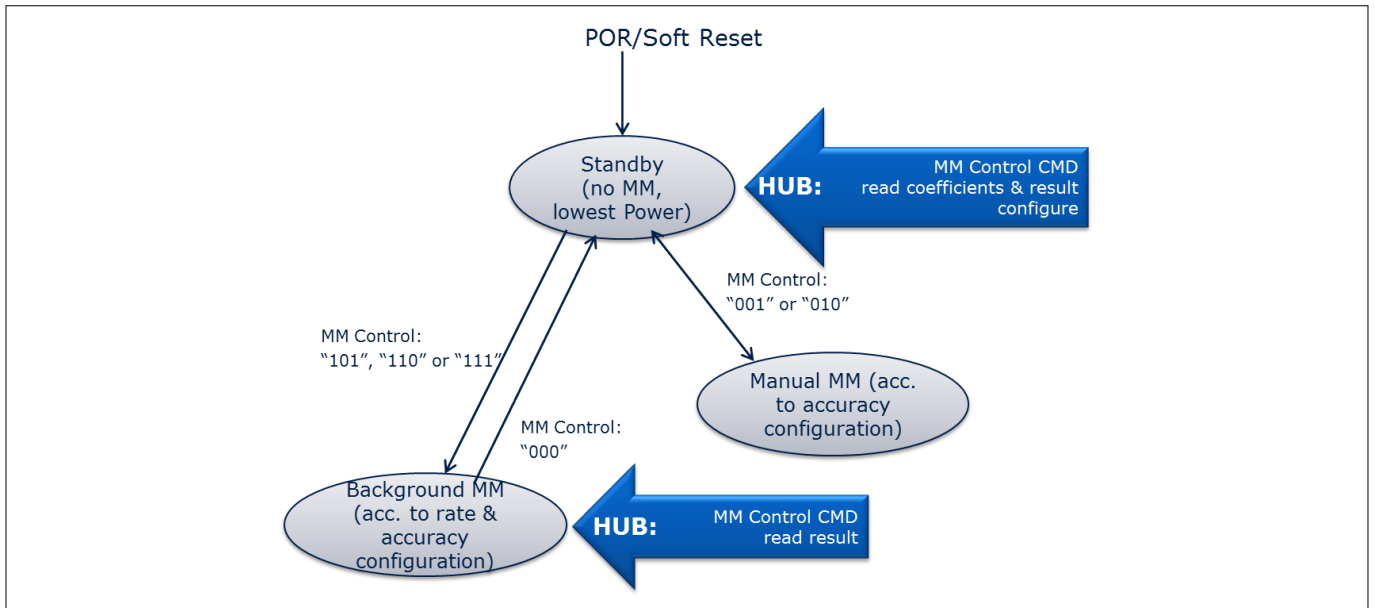
- Standby Mode
  - Default mode after power on or reset. No measurements are performed.
  - All registers and compensation coefficients are accessible.
- Command Mode
  - One temperature or pressure measurement is performed according to the selected precision.
  - The sensor will return to Standby Mode when the measurement is finished, and the measurement result will be available in the data registers.
- Background Mode
  - Pressure and/or temperature measurements are performed continuously according to the selected measurement precision and rate. The temperature measurement is performed immediately after the pressure measurement.
  - The FIFO can be used to store 32 measurement results and minimize the number of times the sensor must be accessed to read out the results.

Note: Operation mode and measurement type are set in the **Sensor Operating Mode and Status (MEAS\_CFG)** register.

**4.2 Mode transition diagram**

The mode transition diagram is shown below.

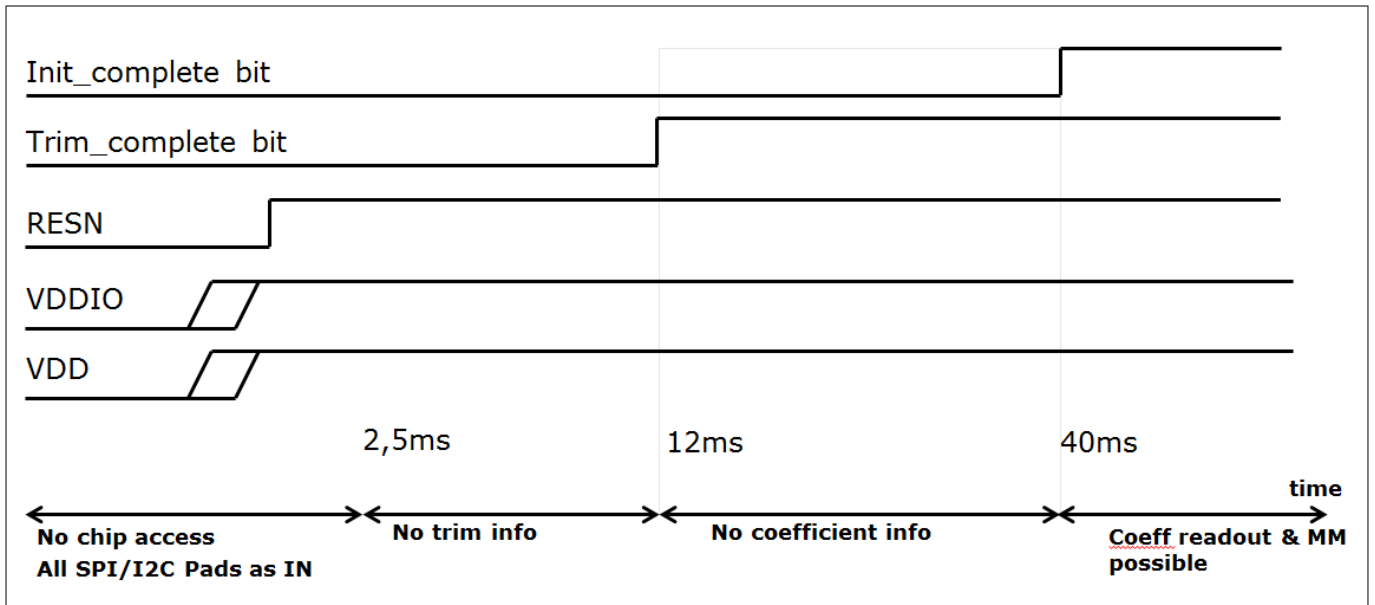
**Functional Description**



**Figure 3 Mode transition diagram**

**4.3 Start-up sequence**

The start-up sequence is shown below. This diagram shows when the registers are accessible for read and/or write and also when the Pressure/Temperature measurements can start.



**Figure 4 Start-up sequence**

**4.4 Measurement Precision and Rate**

Different applications require different measurement precision and measurement rates. Some applications, such as weather stations, require lower precision and measurement rates than for instance indoor navigation and sports applications.

When the DPS310 is in Background Mode, the measurement precision and rate can be configured to match the requirements of the application. This reduces current consumption of the sensor and the system.

**Functional Description**

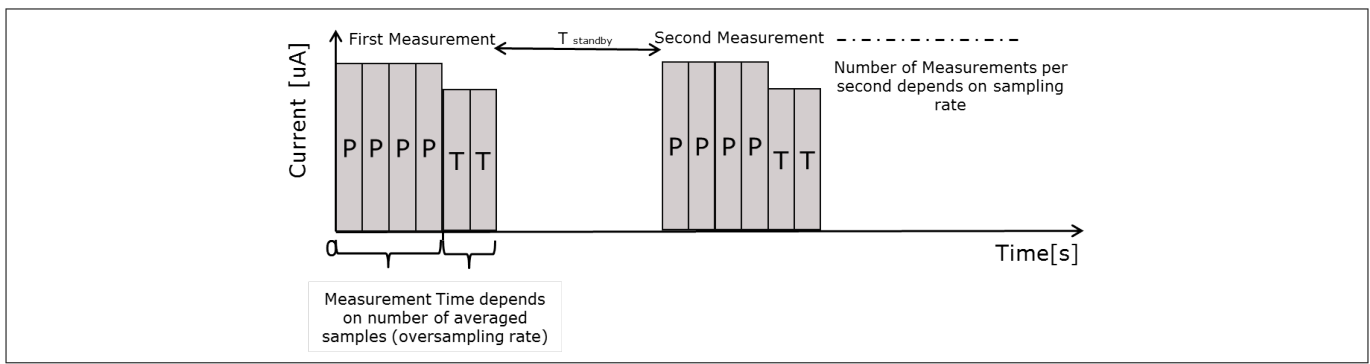
In order to achieve a higher precision, the DPS310 will read the sensor multiple times (oversampling), and combine the readings into one result. This increases the current consumption and also the measurement time, reducing the maximum possible measurement rate. It is necessary to balance the accuracy and data rate required for each application with the allowable current consumption.

The measurement precision, rate and time is set in the **Pressure Configuration (PRS\_CFG)** and **Temperature Configuration (TMP\_CFG)** registers. The register descriptions contain information about the current consumption and the possible combinations of measurement precision, time, and rate.

Enabling temperature measurements allows for compensation of temperature drift in the pressure measurement. The rates of these measurements can be set independently, but temperature compensation is more accurate when temperature and pressure measurements are taken together. This reduces the maximum pressure measurement rate, since:  $Rate_{temperature} * Time_{temperature} + Rate_{pressure} * Time_{pressure} < 1 \text{ second}$ .

**Measurement Settings and Use Case Examples** contains a table with examples of combinations of pressure and temperature precision and rates for different use cases.

In the figure below is described the Temperature and Pressure measurements sequence in background mode.



**Figure 5 Background mode temperature and pressure measurements sequence**

**4.5 Sensor Interface**

The DPS310 can be accessed as a slave device through mode '11' SPI 3-wire, SPI 4-wire, or I<sup>2</sup>C serial interface.

- I<sup>2</sup>C interface
  - The sensor's default interface.
  - The sensor's address is 0x77 (default) or 0x76 (if the SDO pin is pulled-down to GND).
- SPI interface
  - The sensor will switch to SPI configuration if it detects an active low on the CSB pin. SPI 4-wire is the default SPI interface.
  - To enable SPI 3-wire configuration, a bit must be set in the **Interrupt and FIFO configuration (CFG\_REG)** register after start up.

More details about digital interfaces are available in the **Digital interfaces**.

**4.6 Interrupt**

The DPS310 can generate an interrupt when a new measurement result is available and/or when the FIFO is full. The sensor uses the SDO pin for the interrupt signal, and interrupt is therefore not supported if the interface is 4-wire SPI.

The interrupt is enabled and configured in the **Interrupt and FIFO configuration (CFG\_REG)** register. In I<sup>2</sup>C configuration the SDO pin serves as both interrupt and as the least significant bit in the device address. If the SDO pin is pulled low the interrupt polarity must be set to active high and vice-versa.

The interrupt status can be read from the **Interrupt Status (INT\_STS)** register.

---

## Functional Description

### 4.7 Result Register Operation

After starting the measurements, the latest pressure and temperature raw data will be available in their respective result registers. Temperature measurement can be skipped. The temperature measurements can be disabled if there is a requirement to measure pressure rapidly, but it will make accurate temperature drift compensation impossible.

All measurement data can be read in a single command using auto-increment read. When FIFO is disabled, reading the result register will not affect the register value, it will only be updated when a new measurement is completed. When FIFO is enabled, the pressure result register will update to the next value in the FIFO after each read. When all of the FIFO values have been read, the result register will be set to 0x800000.

### 4.8 FIFO Operation

The DPS310 FIFO can store the last 32 measurements of pressure or temperature. This reduces the overall system power consumption as the host processor does not need to continuously poll data from the sensor but can go into standby mode for longer periods of time.

The FIFO can store any combination of pressure and temperature results, according to the background mode measurement rate settings. The pressure rate can for instance be set 4 times higher than the temperature rate and thus only every fifth result will be a temperature result. The measurement type can be seen in the result data. The sensor will set the least significant bit to:

- '1' if the result is a pressure measurement.
- '0' if it is a temperature measurement.
  - The sensor uses 24 bits to store the measurement result. Because this is more bits than is needed to cover the full dynamic range of the pressure sensor, using the least significant bit to label the measurement type will not affect the precision of the result.

The FIFO can be enabled in the Interrupt and FIFO configuration register. The data from the FIFO is read out from the Pressure Data (PRS\_Bn) registers regardless of whether the next result in the FIFO is a temperature or a pressure measurement.

When a measurement has been read out, the FIFO will auto increment and place the next result in the data register. A flag will be set in the FIFO Status register when the FIFO is empty and all following reads will return 0x800000.

If the FIFO is full, the FIFO\_FULL bit in the FIFO Status (FIFO\_STS) will be set. If the INT\_FIFO bit in the Interrupt and FIFO configuration register (CFG\_REG) is set, an interrupt will also be generated when the FIFO is full.

The FIFO will stop recording measurements results when it is full.

### 4.9 Calibration and Measurement Compensation

The DPS310 is a calibrated sensor and contains calibration coefficients. These are used in the application (for instance by the host processor) to compensate the measurement results for sensor non-linearities.

The sections that follow describe how to calculate the compensated results and convert them into Pa and °C values.

## Functional Description

### 4.9.1 How to Calculate Compensated Pressure Values

#### Steps

1. Read the pressure calibration coefficients (c00, c10, c20, c30, c01, c11, and c21) from the Calibration Coefficient register.

*Note:* The coefficients read from the coefficient register are 2's complement numbers.

2. Choose scaling factors kT (for temperature) and kP (for pressure) based on the chosen precision rate. The scaling factors are listed in [Table 9](#).
3. Read the pressure and temperature result from the registers or FIFO.

*Note:* The measurements read from the result registers (or FIFO) are 24 bit 2's complement numbers. Depending on the chosen measurement rates, the temperature may not have been measured since the last pressure measurement.

4. Calculate scaled measurement results.

$$\begin{aligned}T_{\text{raw\_sc}} &= T_{\text{raw}}/kT \\ P_{\text{raw\_sc}} &= P_{\text{raw}}/kP\end{aligned}$$

5. Calculate compensated measurement results.

$$P_{\text{comp}}(\text{Pa}) = c00 + P_{\text{raw\_sc}} * (c10 + P_{\text{raw\_sc}} * (c20 + P_{\text{raw\_sc}} * c30)) + T_{\text{raw\_sc}} * c01 + T_{\text{raw\_sc}} * P_{\text{raw\_sc}} * (c11 + P_{\text{raw\_sc}} * c21)$$

### 4.9.2 How to Calculate Compensated Temperature Values

#### Steps

1. Read the temperature calibration coefficients (c0 and c1) from the [Calibration Coefficients \(COEF\)](#) register.

*Note:* The coefficients read from the coefficient register are 12 bit 2's complement numbers.

2. Choose scaling factor kT (for temperature) based on the chosen precision rate. The scaling factors are listed in [Table 9](#).
3. Read the temperature result from the temperature register or FIFO.

*Note:* The temperature measurements read from the temperature result register (or FIFO) are 24 bit 2's complement numbers.

4. Calculate scaled measurement results.

$$T_{\text{raw\_sc}} = T_{\text{raw}}/kT$$

5. Calculate compensated measurement results.

**Functional Description**

$$T_{\text{comp}} (\text{°C}) = c0*0.5 + c1*T_{\text{raw\_sc}}$$

**4.9.3 Compensation Scale Factors**

**Table 9 Compensation Scale Factors**

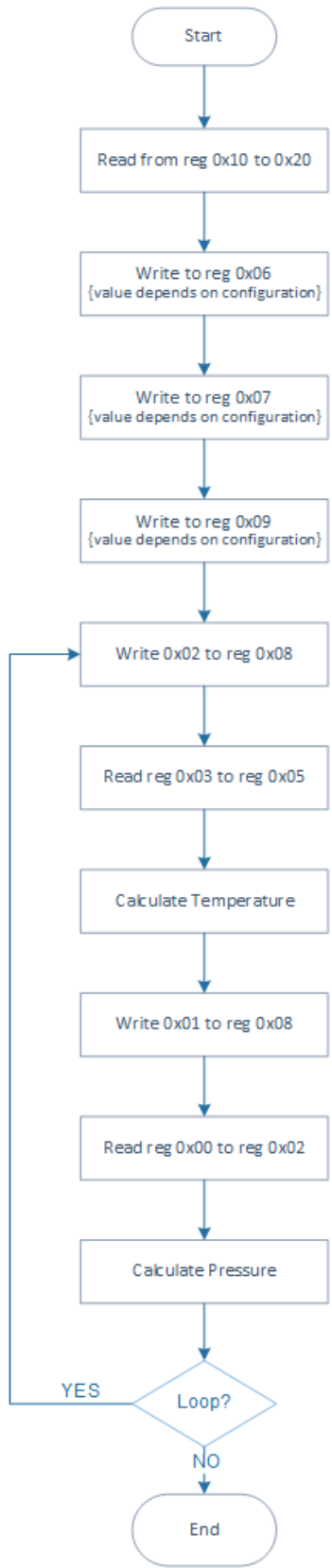
Oversampling Rate	Scale Factor (kP or kT)	Result shift ( bit 2and 3 address 0x09)
1 (single)	524288	0
2 times (Low Power)	1572864	0
4 times	3670016	0
8 times	7864320	0
16 times (Standard)	253952	enable pressure or temperature shift
32 times	516096	enable pressure or temperature shift
64 times (High Precision)	1040384	enable pressure or temperature shift
128 times	2088960	enable pressure or temperature shift

**4.9.4 Pressure and Temperature calculation flow**

The flow chart below describes the Pressure and Temperature calculate

**Figure 6 Pressure and temperature calculation flow**

Functional Description



See also [How to Calculate Compensated Pressure Values](#) and [How to Calculate Compensated Temperature Values](#)



Applications

## 5 Applications

### 5.1 Measurement Settings and Use Case Examples

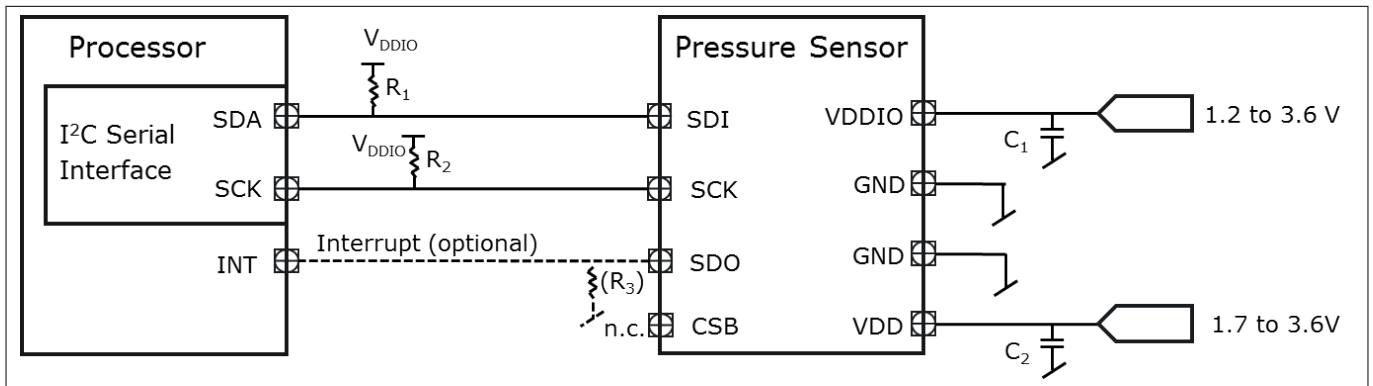
**Table 10 Measurement Settings and Use Case Examples (TBD)**

Use Case	Performance	Pressure Register Configuration Address: 0x06	Temperature Register Configuration Address: 0x07	Other
Weather Station (Low power)	5 Pa precision. 1 pr sec. 3 uA	0x01	0x80	Start background measurements (addr 0x08)
Indoor navigation (Standard precision, background mode)	10 cm precision. 2 pr sec. 22 uA	0x14	0x90	Enable P shift (addr 0x09) Start background measurements (addr 0x08)
Sports (High precision, high rate, background mode)	5 cm precision 4 pr sec. 200 uA	0x26	0xA0	Enable P shift (addr 0x09) Start background measurements (addr 0x08)

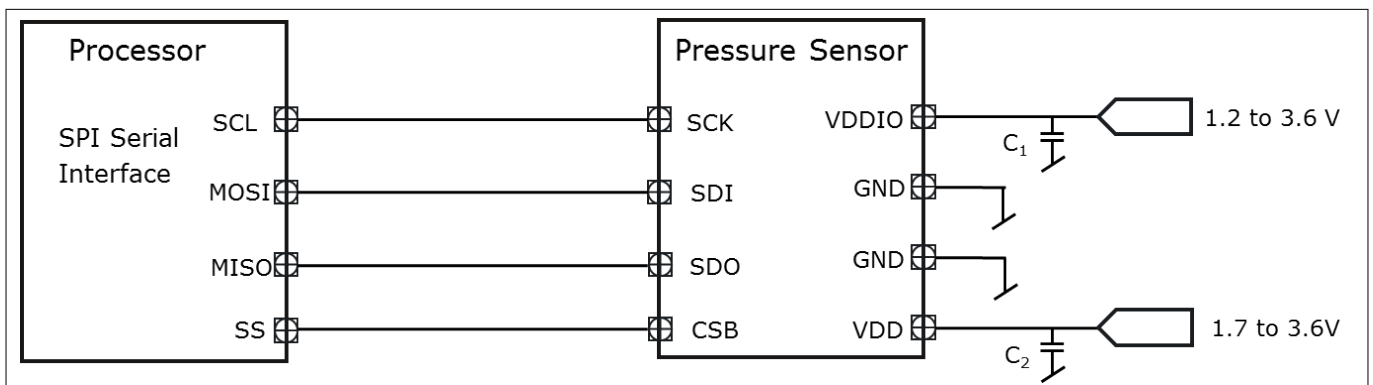
**Applications**

**5.2 Application Circuit Example**

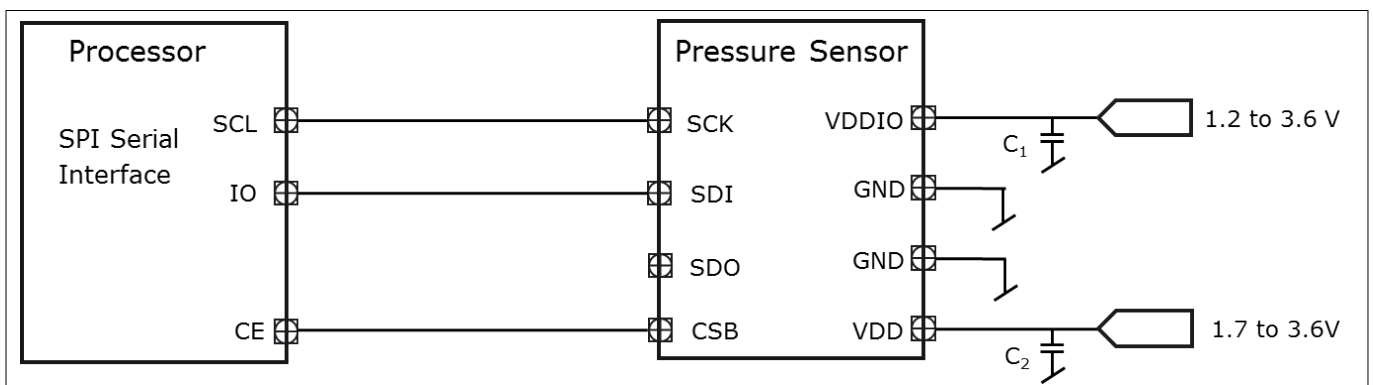
The examples application circuit uses the I<sup>2</sup>C and SPI serial interface. The SDO pin can be used for interrupt or to set least significant bit of the device address. The DPS310 analog core supply voltage is internally regulated, guaranteeing robustness to external VDD supply variations within the specified range. The simplest voltage supply solution is to connect VDD and VDDIO to 1.8V supply and add a suitable decoupling capacitor to reduce VDD ripple below 50mVpp.



**Figure 7 Application Circuit Example using the I<sup>2</sup>C serial interface.**

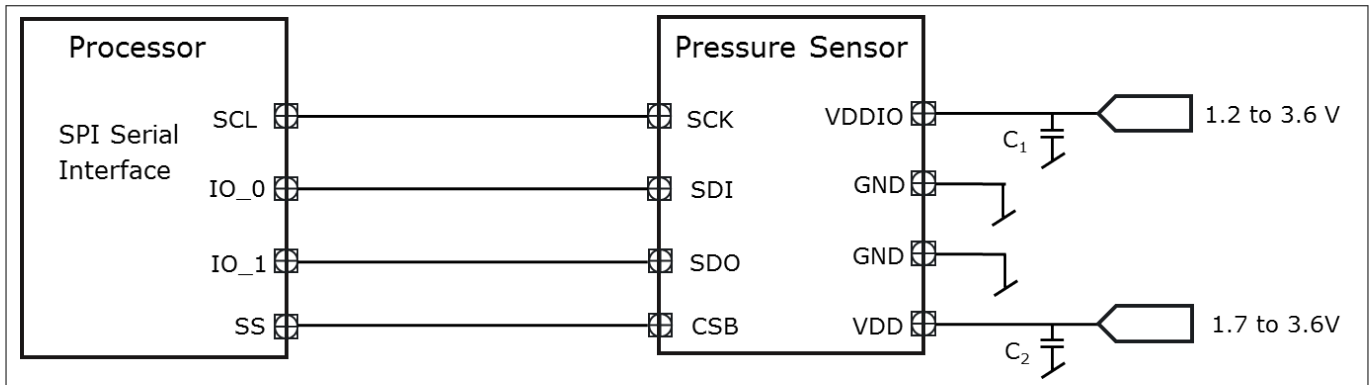


**Figure 8 Application Circuit Example using the SPI 4-wires serial interface**



**Figure 9 Application Circuit Example using the SPI 3-wire serial interface**

**Digital interfaces**



**Figure 10 Application Circuit Example using the SPI 3-wire with interrupt interface**

**Table 11 Component Values**

Component	Symbol	Values			Unit	Note / Test Condition
		Min.	Typ.	Max.		
Pull-up/down Resistor	R <sub>1</sub> , R <sub>2</sub>			10	KΩ	
	R <sub>3</sub>			100	KΩ	R <sub>3</sub> is optional and will set the address to 0x76 instead of 0x77.
Supply Blocking Capacitor	C <sub>1</sub> , C <sub>2</sub>	100	100		nF	The blocking capacitors should be placed as close to the package pins as possible.

**5.3 IIR filtering**

The air pressure is slowly changing due to weather conditions or short term changing like air turbulence created by a fan, slamming a door or window. All these disturbances can be suppressed or triggered on the software application level by implementing different IIR filtering.

Same sensor can be used by different software applications applying different IIR filtering to the raw data like low pass, high pass or band pass filtering.

**6 Digital interfaces**

The DPS310 measurement data, calibration coefficients, Product ID and configuration registers can be accessed through both the I<sup>2</sup>C and SPI serial interfaces.

The SPI interface can be configured to operate in 3-wire or 4-wire mode. In I<sup>2</sup>C and SPI 3-wire, an interrupt output can be implemented on the SDO pin. The SPI interface support mode '11' only (CPOL=CPHA='1') in 4-wire and 3-wire configuration. The following commands are supported: single byte write, single byte read and multiple byte read using auto increment from a specified start address. The interface selection is done based on CSB pin status. If CSB is connected to V<sub>DDIO</sub>, the I<sup>2</sup>C interface is active. If CSB is low, the SPI interface is active. After the CSB has been pulled down once the I<sup>2</sup>C interface is disabled until the next power-on-reset.

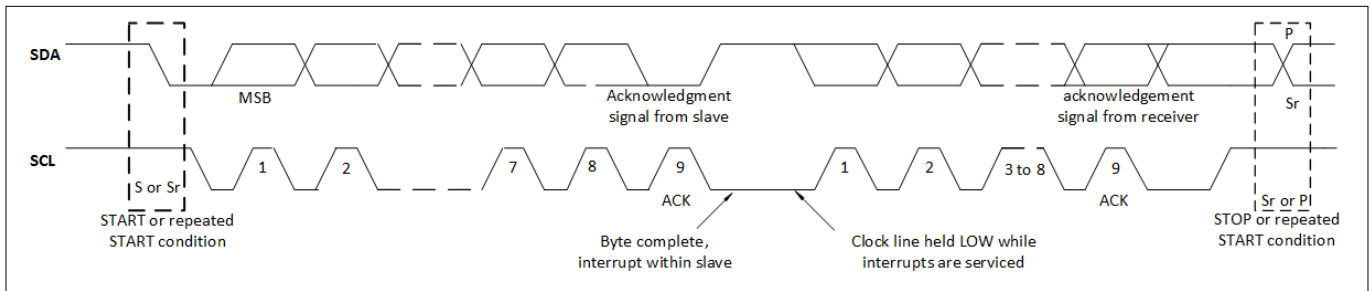
**Digital interfaces**

**6.1 I2C Interface**

The I<sup>2</sup>C slave interface is compatible with Philips I<sup>2</sup>C Specification version 2.1. The I<sup>2</sup>C interface supports standard, fast and high speed mode.

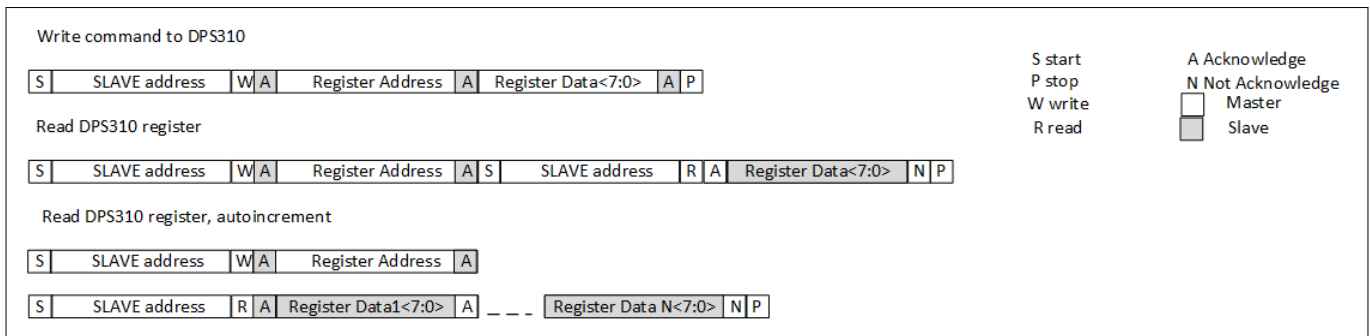
The sensor's address is 0x77 (if SDO pin is left floating or pulled-up to VDDIO) or 0x76 (if the SDO pin is pulled-down to GND). The I<sup>2</sup>C interface uses the pins described in [Table 2](#)

The basic timing is shown in the diagram below:



**Figure 11 I2C timing diagram**

In one access, without stop, incremental read (address is auto increment) and auto-incremental write is supported. The read and write access is described below:



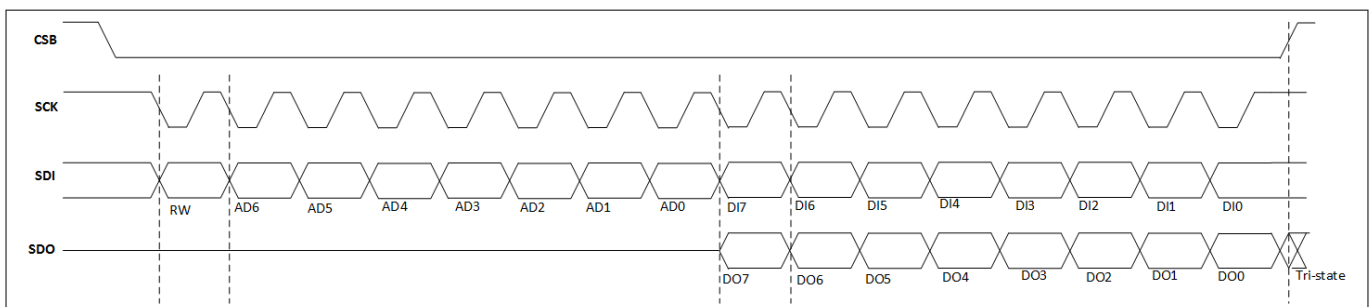
**Figure 12 I2C write and read commands**

**6.2 SPI Interface**

The SPI interface is compatible with SPI mode '11' (CPOL = CPHA = '1'). The SPI interface has two modes: 4-wire and 3-wire.

The protocol is the same for both. The 3-wire mode is selected by setting '1' to the register [Interrupt and FIFO configuration \(CFG\\_REG\)](#)

The SPI interface uses the pins like in the [Table 2](#) Refer to [Application Circuit Example](#) for connections instructions. The SPI protocol is shown in the diagram below:

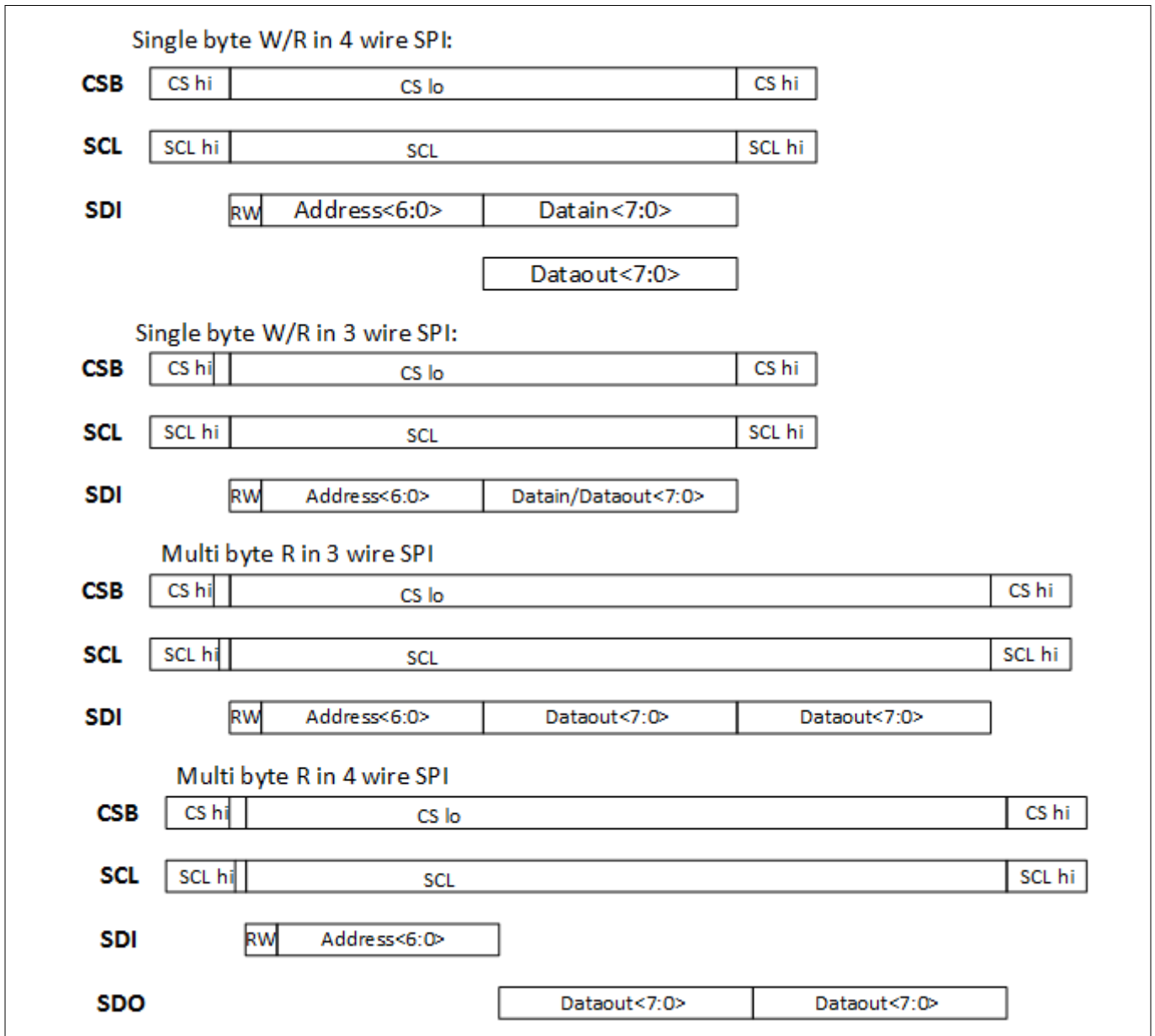


**Figure 13 SPI protocol, 4-wire without interrupt**

**Digital interfaces**

A SPI write is carried out by setting CSB low and sending a control byte followed by register data. The control byte consist of the SPI register address ( full register address without bit 7) and the write command ( bit7 = RW = '0'). Setting CSB high ends the transaction. The SPI write protocol is described in the diagram below.

A SPI read is initiated by setting CSB low and sending a single control byte. The control byte consist of the SPI register address (= full register address without bit 7) and the read command ( bit7 = RW = '1'). After writing the control byte, data is sent out of the SDO pin ( SDI in 3-wire mode); the register address is automatically incremented. Sending CSB high ends the SPI read transaction. The SPI read protocol is shown in the diagram below:



**Figure 14 SPI write, read protocol diagrams**

**6.3 Interface parameters specification**

**Digital interfaces**

**6.3.1 General interface parameters**

The general interface parameters are given in the table below:

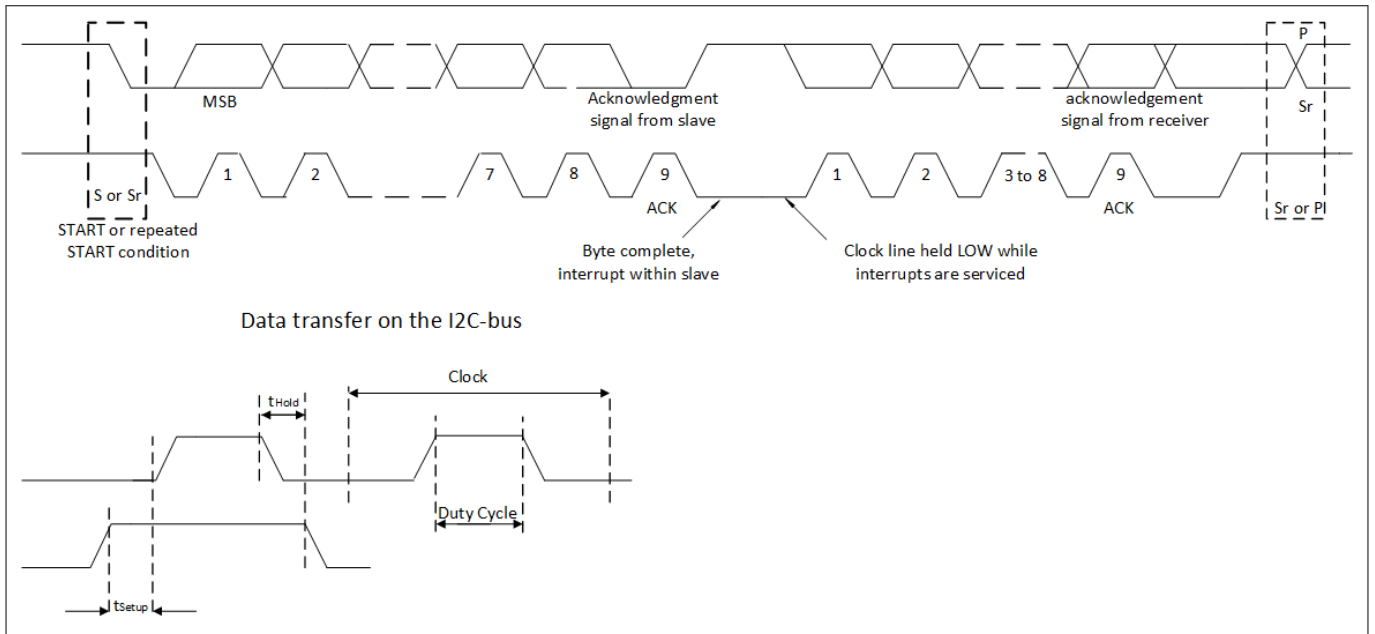
**Table 12 Interface parameters**

Parameter	Symbol	Values			Unit	Note or Test Condition
		Min.	Typ.	Max.		
Input voltage for low logic level at input pins	Vlow_in			0.3 * V <sub>DDIO</sub>	V	V <sub>DDIO</sub> =1.2V to 3.6V
Input voltage for high logic level at input pins	Vhigh_in	0.7 * V <sub>DDIO</sub>			V	V <sub>DDIO</sub> =1.2V to 3.6V
Output - low level for I2C	Vlow_SDI			0.1 * V <sub>DDIO</sub>	V	V <sub>DDIO</sub> =1.8V, i <sub>ol</sub> =2mA
Output voltage for low level at pin SDI for I2C	Vlow_SDI_1.2			0.2* V <sub>DDIO</sub>	V	V <sub>DDIO</sub> =1.20V, i <sub>ol</sub> =1.3mA
Output voltage for high level at pins SDO, SDI	Vhigh_out	0.8 * V <sub>DDIO</sub>			V	V <sub>DDIO</sub> =1.8V, i <sub>ol</sub> =1mA (SDO, SDI)
Output voltage for high level at pins SDO, SDI	Vhigh_out_1.2	0.6 * V <sub>DDIO</sub>			V	V <sub>DDIO</sub> =1.2V, i <sub>ol</sub> =1mA (SDO, SDI)
Pull-up resistor	Rpull	60	120	180	kohm	Internal pull-up resistance to V <sub>DDIO</sub>
I <sup>2</sup> C bus load capacitor	Cb			400	pF	On SDI and SCK

**6.3.1.1 I2C timings**

The I<sup>2</sup>C timing is shown in the diagram below and corresponding values are given in the table below. The naming refers to I<sup>2</sup>C Specification version 2.1, the abbreviations used "S&F mode" = standard and fast mode, "HS mode" = high speed mode, C<sub>b</sub> = bus capacitance on SDA line.

**Digital interfaces**



**Figure 15 I<sup>2</sup>C timing diagram**

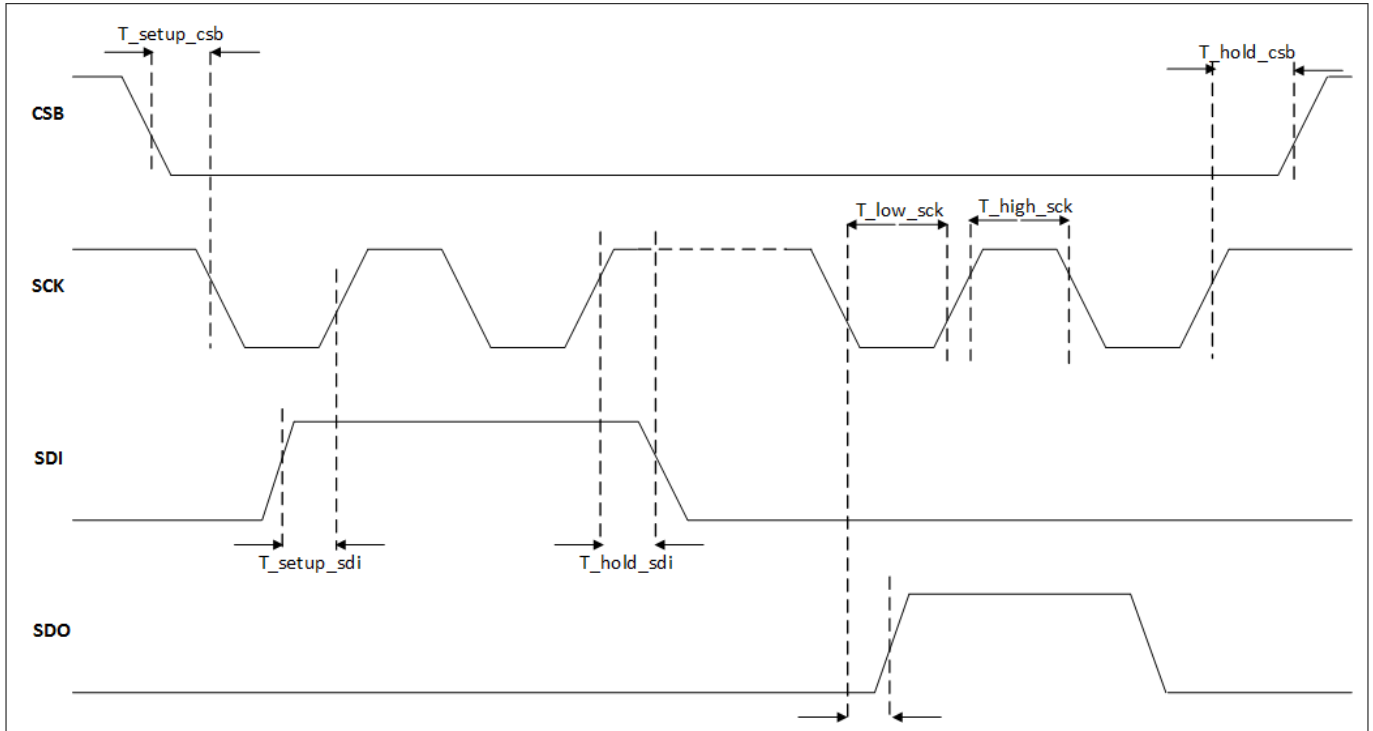
**Table 13 I2C timings**

Parameter	Symbol	Values			Unit	Note or Test Condition
		Min.	Typ.	Max.		
Data setup time on SDI pin	$t_{Setup}$	20			ns	S&F mode
		5			ns	HS mode
Data hold time on SDI pin	$t_{Hold}$	0			ns	S&F&HSmode,
Duty Cycle	DC			70	%	S&F mode,
				55	%	HS mode,

**Digital interfaces**

**6.3.1.2 SPI timings**

The SPI timing diagram is shown in the figure below and the corresponding values are given in the table below. All timings apply both to 4-wire and 3-wire SPI.



**Figure 16 SPI timing diagram**

**Table 14 SPI timings**

Parameter	Symbol	Values			Unit	Note or Test Condition
		Min.	Typ.	Max.		
Duty Cycle (Thigh%)	SPI_DC	30			%	V <sub>DDIO</sub> = 1.2V
		20			%	V <sub>DDIO</sub> = 1.8V/3.6V
SDI setup time	T_setup_sdi	2			ns	
SDI hold time	T_hold_sdi	2			ns	
Clock	SPI_CLK			10	MHz	
CSB setup time	T_setup_csb	15			ns	
CSB hold time		15			ns	



**Register Map**

## 7 Register Map

**Table 15 Register Map**

Register Name	Addr.	bit7	bit6	bit5	bit4	bit3	bit2	bit1	bit0	Reset State
PSR_B2	0x00	PSR[23:16] (r)								00 <sub>h</sub>
PSR_B1	0x01	PSR[15:8](r)								00 <sub>h</sub>
PSR_B0	0x02	PSR[7:0](r)								00 <sub>h</sub>
TMP_B2	0x03	TMP[23:16] (r)								00 <sub>h</sub>
TMP_B1	0x04	TMP[15:8] (r)								00 <sub>h</sub>
TMP_B0	0x05	TMP[7:0] (r)								00 <sub>h</sub>
PRS_CFG	0x06	-	PM_RATE [2:0] (rw)			PM_PRC [3:0] (rw)				00 <sub>h</sub>
TMP_CFG	0x07	TMP_EXT (rw)	TMP_RATE [2:0] (rw)			TM_PRC [3:0] (rw)				00 <sub>h</sub>
MEAS_CFG	0x08	COEF_RDY (r)	SENSOR_RDY (r)	TMP_RDY (r)	PRS_RDY (r)	-	MEAS_CRTL [2:0] (rw)			C0 <sub>h</sub>
CFG_REG	0x09	INT_HL (rw)	INT_SEL [2:0] (rw)			TMP_SHIFT_EN (rw)	PRS_SHIFT_EN (rw)	FIFO_EN (rw)	SPI_MODE (rw)	00 <sub>h</sub>
INT_STS	0x0A	-	-	-	-	-	INT_FIFO_FULL (r)	INT_TMP(r)	INT_PRS(r)	00 <sub>h</sub>
FIFO_STS	0x0B	-	-	-	-	-	-	FIFO_FULL(r)	FIFO_EMPTY(r)	00 <sub>h</sub>
RESET	0x0C	FIFO_FLUSH (w)	-	-	-	SOFT_RST [3:0] (w)				00 <sub>h</sub>
Product ID	0x0D	REV_ID [3:0] (r)				PROD_ID [3:0] (r)				10 <sub>h</sub>
COEF	0x10-0x21	< see register description >								XX <sub>h</sub>
Reserved	0x22-0x27	Reserved								XX <sub>h</sub>
COEF_SRCE	0x28	TMP_COEF_SRCE (r)	Reserved							XX <sub>h</sub>

## 8 Register description

### 8.1 Pressure Data (PRS\_Bn)

The Pressure Data registers contains the 24 bit (3 bytes) 2's complement pressure measurement value.

If the FIFO is enabled, the register will contain the FIFO pressure and/or temperature results. Otherwise, the register contains the pressure measurement results and will not be cleared after read.

**Register description**

**8.1.1 PRS\_B2**

The highest byte of the three bytes measured pressure value.

PRS\_B2 **Address:** 00<sub>H</sub>  
 Pressure (MSB data) **Reset value:** 00<sub>H</sub>

7	6	5	4	3	2	1	0
<b>PRS23</b>	<b>PRS22</b>	<b>PRS21</b>	<b>PRS20</b>	<b>PRS19</b>	<b>PRS18</b>	<b>PRS17</b>	<b>PRS16</b>
r							

Field	Bits	Type	Description
PRS[23:16]	7:0	r	MSB of 24 bit 2's complement pressure data.

**8.1.2 PRS\_B1**

The middle byte of the three bytes measured pressure value.

PRS\_B1 **Address:** 01<sub>H</sub>  
 Pressure (LSB data) **Reset value:** 00<sub>H</sub>

7	6	5	4	3	2	1	0
<b>PRS15</b>	<b>PRS14</b>	<b>PRS13</b>	<b>PRS12</b>	<b>PRS11</b>	<b>PRS10</b>	<b>PRS9</b>	<b>PRS8-</b>
r							

Field	Bits	Type	Description
PRS[15:8]	7:0	r	LSB of 24 bit 2's complement pressure data.

**Register description**

**8.1.3 PRS\_B0**

The lowest byte of the three bytes measured pressure value.

PRS\_B0 **Address:** 02<sub>H</sub>  
 Pressure (XLSB data) **Reset value:** 00<sub>H</sub>

7	6	5	4	3	2	1	0
<b>PRS7</b>	<b>PRS6</b>	<b>PRS5</b>	<b>PRS4</b>	<b>PRS3</b>	<b>PRS2</b>	<b>PRS1</b>	<b>PRS0</b>

r

Field	Bits	Type	Description
PRS[7:0]	7:0	r	XLSB of 24 bit 2's complement pressure data.

**8.2 Temperature Data (TMP\_Tn)**

The Temperature Data registers contain the 24 bit (3 bytes) 2's complement temperature measurement value ( unless the FIFO is enabled, please see FIFO operation ) and will not be cleared after the read.

**8.2.1 TMP\_B2**

The highest byte of the three bytes measured temperature value.

TMP\_B2 **Address:** 03<sub>H</sub>  
 Temperature (MSB data) **Reset value:** 00<sub>H</sub>

7	6	5	4	3	2	1	0
<b>TMP23</b>	<b>TMP22</b>	<b>TMP21</b>	<b>TMP20</b>	<b>TMP19</b>	<b>TMP18</b>	<b>TMP17</b>	<b>TMP16</b>

r

Field	Bits	Type	Description
TMP[23:16]	7:0	r	MSB of 24 bit 2's complement temperature data.

**Register description**

**8.2.2 TMP\_B1**

The middle byte of the three bytes measured temperature value.

TMP\_B1 **Address:** 04<sub>H</sub>  
 Temperature (LSB data) **Reset value:** 00<sub>H</sub>

7	6	5	4	3	2	1	0
<b>TMP15</b>	<b>TMP14</b>	<b>TMP13</b>	<b>TMP12</b>	<b>TMP11</b>	<b>TMP10</b>	<b>TMP9</b>	<b>TMP8</b>
r							

Field	Bits	Type	Description
TMP[15:8]	7:0	r	LSB of 24 bit 2's complement temperature data.

**8.2.3 TMP\_B0**

The lowest part of the three bytes measured temperature value.

TMP\_B0 **Address:** 05<sub>H</sub>  
 Temperature (XLSB data) **Reset value:** 00<sub>H</sub>

7	6	5	4	3	2	1	0
<b>TMP7</b>	<b>TMP6</b>	<b>TMP5</b>	<b>TMP4</b>	<b>TMP3</b>	<b>TMP2</b>	<b>TMP1</b>	<b>TMP0</b>
r							

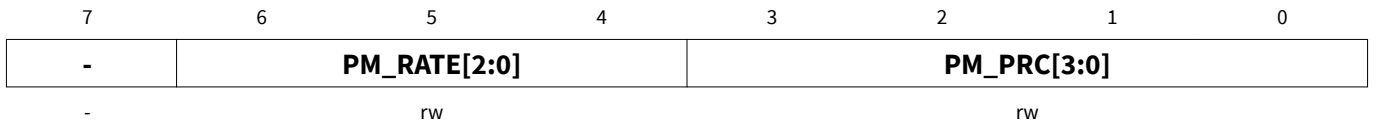
Field	Bits	Type	Description
TMP[7:0]	7:0	r	XLSB of 24 bit 2's complement temperature data.

**Register description**

**8.3 Pressure Configuration (PRS\_CFG)**

Configuration of pressure measurement rate (PM\_RATE) and resolution (PM\_PRC).

PRS\_CFG **Address:** 06<sub>H</sub>  
 Pressure measurement configuration **Reset value:** 00<sub>H</sub>



Field	Bits	Type	Description
-	7	-	Reserved.
PM_RATE[2:0]	6:4	rw	Pressure measurement rate: 000 - 1 measurements pr. sec. 001 - 2 measurements pr. sec. 010 - 4 measurements pr. sec. 011 - 8 measurements pr. sec. 100 - 16 measurements pr. sec. 101 - 32 measurements pr. sec. 110 - 64 measurements pr. sec. 111 - 128 measurements pr. sec. <i>Applicable for measurements in Background mode only</i>
PM_PRC[3:0]	3:0	rw	Pressure oversampling rate: 0000 - Single. (Low Precision) 0001 - 2 times (Low Power). 0010 - 4 times. 0011 - 8 times. 0100 *) - 16 times (Standard). 0101 *) - 32 times. 0110 *) - 64 times (High Precision). 0111 *) - 128 times. 1xxx - Reserved

\*) Note: Use in combination with a bit shift. See [Interrupt and FIFO configuration \(CFG\\_REG\)](#) register

**Register description**

**Table 16 Precision (Pa<sub>RMS</sub>) and pressure measurement time (ms) versus oversampling rate**

Oversampling (PRC[3:0])	Single (0000)	2 times (0001)	4 times (0010)	8 times (0011)	16 times (0100)	32 times (0101)	64 times (0110)	128 times (0111)
Measurement time (ms)	3.6	5.2	8.4	14.8	27.6	53.2	104.4	206.8
Precision (Pa <sub>RMS</sub> )	5		2.5		1.2	0.9	0.5	

**Table 17 Estimated current consumption (uA)**

Oversampling (PRC[3:0])	Single (0000)	2 times (0001)	4 times (0010)	8 times (0011)	16 times (0100)	32 times (0101)	64 times (0110)	128 times (0111)
Measurements pr sec. (PM_RATE([2:0])								
<b>1 (000)</b>	2.1	2.7	3.8	6.1	11	20	38	75
<b>2 (001)</b>								
<b>4 (010)</b>								
<b>8 (011)</b>	<i>Note: The current consumption can be calculated as the Measurement Rate * Current Consumption of 1 measurement per. sec.</i>							n.a.
<b>16 (100)</b>							n.a.	n.a.
<b>32 (101)</b>						n.a.	n.a.	n.a.
<b>64 (110)</b>					n.a.	n.a.	n.a.	n.a.
<b>128 (111)</b>			n.a.	n.a.	n.a.	n.a.	n.a.	n.a.

*Note: The table shows the possible combinations of Pressure Measurement Rate and oversampling when no temperature measurements are performed. When temperature measurements are performed the possible combinations are limited to  $Rate_{temperature} \times Measurement\ Time_{temperature} + Rate_{pressure} \times Measurement\ Time_{pressure} < 1\ second$ .*

The temperature measurement time versus temperature oversampling rate is similar with pressure measurement time versus pressure oversampling rate

**Register description**

**8.4 Temperature Configuration(TMP\_CFG)**

Configuration of temperature measurement rate (TMP\_RATE) and resolution (TMP\_PRC).

TMP\_CFG **Address:** 07<sub>H</sub>  
 Temperature measurement configuration **Reset value:** 00<sub>H</sub>

7	6	5	4	3	2	1	0
<b>TMP_EXT</b>	<b>TMP_RATE[6:4]</b>			<b>TMP_PRC[3:0]</b>			
rw	rw			-	rw		

Field	Bits	Type	Description
TMP_EXT	7	rw	Temperature measurement 0 - Internal sensor (in ASIC) 1 - External sensor (in pressure sensor MEMS element) <i>Note: It is highly recommended to use the same temperature sensor as the source of the calibration coefficients. Please see the <a href="#">Coefficient Source</a> register</i>
TMP_RATE[2:0]	6:4	rw	Temperature measurement rate: 000 - 1 measurement pr. sec. 001 - 2 measurements pr. sec. 010 - 4 measurements pr. sec. 011 - 8 measurements pr. sec. 100 - 16 measurements pr. sec. 101 - 32 measurements pr. sec. 110 - 64 measurements pr. sec. 111 - 128 measurements pr. sec.. <i>Applicable for measurements in Background mode only</i>
TMP_PRC[2:0]	3:0	rw	Temperature oversampling (precision): 0000 - single. (Default) - Measurement time 3.6 ms. <i>Note: Following are optional, and may not be relevant:</i> 0001 - 2 times. 0010 - 4 times. 0011 - 8 times. 0100 - 16 times. 0101 - 32 times. 0110 - 64 times.. 0111 - 128 times. 1xxx - Reserved.

**Register description**

**8.5 Sensor Operating Mode and Status (MEAS\_CFG)**

Setup measurement mode.

MEAS\_CFG **Address:** 08<sub>H</sub>  
 Measurement configuration **Reset value:** C0<sub>H</sub>

7	6	5	4	3	2	1	0
<b>COEF_RDY</b>	<b>SENSOR_RDY</b>	<b>TMP_RDY</b>	<b>PRS_RDY</b>	-	<b>MEAS_CTRL</b>		
r	r	r	r	-	rw		

Field	Bits	Type	Description
COEF_RDY	7	r	Coefficients will be read to the Coefficients Registers after start-up: 0 - Coefficients are not available yet. 1 - Coefficients are available.
SENSOR_RDY	6	r	The pressure sensor is running through self initialization after start-up. 0 - Sensor initialization not complete 1 - Sensor initialization complete It is recommend not to start measurements until the sensor has completed the self intialization.
TMP_RDY	5	r	Temperature measurement ready 1 - New temperature measurement is ready. Cleared when temperature measurement is read.
PRS_RDY	4	r	Pressure measurement ready 1 - New pressure measurement is ready. Cleared when pressurement measurement is read.
-	3	-	Reserved.
MEAS_CTRL	2:0	rw	Set measurement mode and type: <i>Standby Mode</i> 000 - Idle / Stop background measurement <i>Command Mode</i> 001 - Pressure measurement 010 - Temperature measurement 011 - na. 100 - na. <i>Background Mode</i> 101 - Continous pressure measurement 110 - Continous temperature measurement 111 - Continous pressure and temperature measurement



**Register description**

**8.6 Interrupt and FIFO configuration (CFG\_REG)**

Configuration of interrupts, measurement data shift, and FIFO enable.

CFG\_REG **Address:** 09<sub>H</sub>  
 Configuration register **Reset value:** 00<sub>H</sub>

7	6	5	4	3	2	1	0
<b>INT_HL</b>	<b>INT_FIFO</b>	<b>INT_TMP</b>	<b>INT_PRS</b>	<b>T_SHIFT</b>	<b>P_SHIFT</b>	<b>FIFO_EN</b>	<b>SPI_MODE</b>
rw	rw	rw	rw	rw	rw	rw	rw

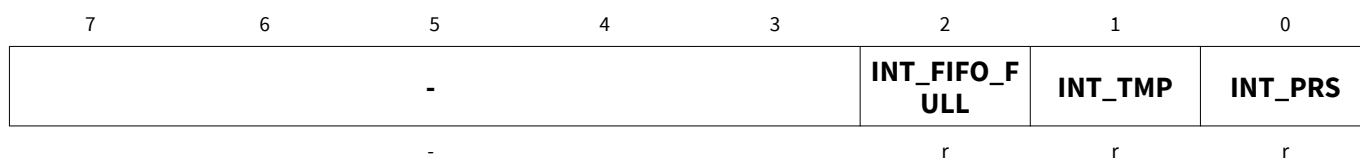
Field	Bits	Type	Description
INT_HL	7	rw	Interrupt (on SDO pin) active level: 0 - Active low. 1 - Active high.
INT_FIFO	6	rw	Generate interrupt when the FIFO is full: 0 - Disable. 1 - Enable.
INT_TMP	5	rw	Generate interrupt when a temperature measurement is ready: 0 - Disable. 1 - Enable.
INT_PRS	4	rw	Generate interrupt when a pressure measurement is ready: 0 - Disable. 1 - Enable.
T_SHIFT	3	rw	Temperature result bit-shift 0 - no shift. 1 - shift result right in data register. <i>Note: Must be set to '1' when the oversampling rate is &gt;8 times.</i>
P_SHIFT	2	rw	Pressure result bit-shift 0 - no shift. 1 - shift result right in data register. <i>Note: Must be set to '1' when the oversampling rate is &gt;8 times.</i>
FIFO_EN	1	rw	Enable the FIFO: 0 - Disable. 1 - Enable.
SPI_MODE	0	rw	Set SPI mode: 0 - 4-wire interface. 1 - 3-wire interface.

**Register description**

**8.7 Interrupt Status (INT\_STS)**

Interrupt status register. The register is cleared on read.

INT\_STS **Address:** 0A<sub>H</sub>  
 Interrupt status **Reset value:** 00<sub>H</sub>



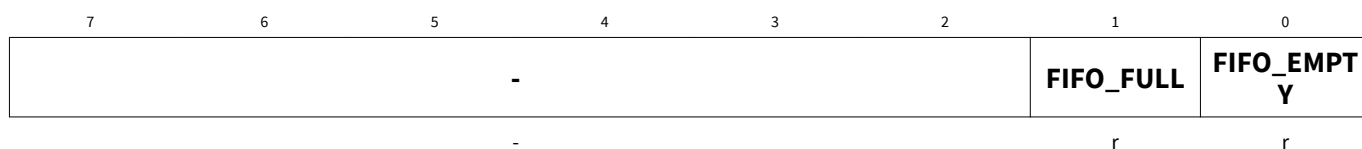
Field	Bits	Type	Description
-	7:3	-	Reserved.
INT_FIFO_FULL	2	r	Status of FIFO interrupt 0 - Interrupt not active 1 - Interrupt active
INT_TMP	1	r	Status of temperature measurement interrupt 0 - Interrupt not active 1 - Interrupt active
INT_PRS	0	r	Status of pressure measurement interrupt 0 - Interrupt not active 1 - Interrupt active

**Register description**

**8.8 FIFO Status (FIFO\_STS)**

FIFO status register

FIFO\_STS **Address:** 0B<sub>H</sub>  
 FIFO status register **Reset value:** 00<sub>H</sub>



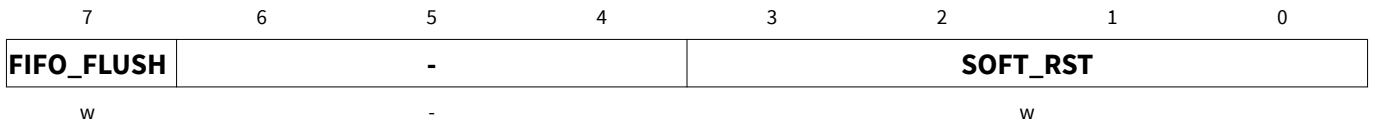
Field	Bits	Type	Description
-	7:2	-	Reserved.
FIFO_FULL	1	r	0 - The FIFO is not full 1 - The FIFO is full
FIFO_EMPTY	0	r	0 - The FIFO is not empty 1 - The FIFO is empty

**Register description**

**8.9 Soft Reset and FIFO flush (RESET)**

Flush FIFO or generate soft reset.

RESET **Address:** 0C<sub>H</sub>  
 FIFO flush and soft reset **Reset value:** 00<sub>H</sub>

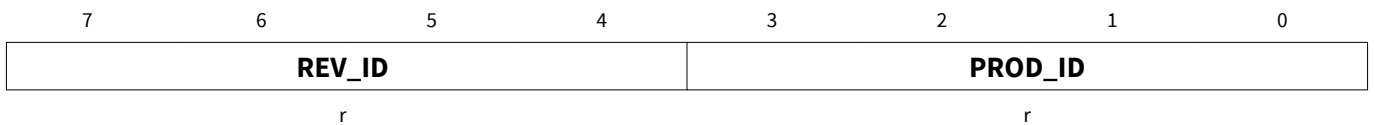


Field	Bits	Type	Description
FIFO_FLUSH	7	w	FIFO flush 1 - Empty FIFO After reading out all data from the FIFO, write '1' to clear all old data.
-	6:4	-	Reserved.
SOFT_RST	3:0	w	Write '1001' to generate a soft reset. A soft reset will run though the same sequences as in power-on reset.

**8.10 Product and Revision ID (ID)**

Product and Revision ID.

ID **Address:** 0D<sub>H</sub>  
 Product and revision ID **Reset value:** 0x10<sub>H</sub>



Field	Bits	Type	Description
REV_ID	7:4	r	Revision ID
PROD_ID	3:0	r	Product ID

**Register description**

**8.11 Calibration Coefficients (COEF)**

The Calibration Coefficients register contains the 2’s complement coefficients that are used to calculate the compensated pressure and temperature values.

**Table 18 Calibration Coefficients**

Coefficient	Addr.	bit7	bit6	bit5	bit4	bit3	bit2	bit1	bit0
c0	0x10	c0 [11:4]							
c0/c1	0x11	c0 [3:0]				c1 [11:8]			
c1	0x12	c1[7:0]							
c00	0x13	c00 [19:12]							
c00	0x14	c00 [11:4]							
c00/c10	0x15	c00 [3:0]				c10 [19:16]			
c10	0x16	c10 [15:8]							
c10	0x17	c10 [7:0]							
c01	0x18	c01 [15:8]							
c01	0x19	c01 [7:0]							
c11	0x1A	c11 [15:8]							
c11	0x1B	c11 [7:0]							
c20	0x1C	c20 [15:8]							
c20	0x1D	c20 [7:0]							
c21	0x1E	c21 [15:8]							
c21	0x1F	c21 [7:0]							
c30	0x20	c30 [15:8]							
c30	0x21	c30 [7:0]							

Note: Generate the decimal numbers out of the calibration coefficients registers data:

$$C20 := \text{reg0x1D} + \text{reg0x1C} * 2^8$$

if (C20 > (2<sup>15</sup> - 1))

$$C20 := C20 - 2^{16}$$

end if

$$C0 := (\text{reg0x10} * 2^4) + ((\text{reg0x11} / 2^4) \& 0x0F)$$

if (C0 > (2<sup>11</sup> - 1))

$$C0 := C0 - 2^{12}$$

end if

## Package Dimensions

### 8.12 Coefficient Source

States which internal temperature sensor the calibration coefficients are based on: the ASIC temperature sensor or the MEMS element temperature sensor. The coefficients are only valid for one sensor and it is highly recommended to use the same temperature sensor in the application. This is set-up in the Temperature Configuration register.

TMP\_COEF\_SRCE **Address:** 28<sub>H</sub>  
 Temperature Coefficients Source **Reset value:** XX<sub>H</sub>

7	6	5	4	3	2	1	0				
<table border="1" style="width: 100%; border-collapse: collapse;"> <tr> <td style="width: 10%;"><b>TMP_COEF_SRCE</b></td> <td style="width: 70%; text-align: center;">-</td> </tr> <tr> <td style="text-align: center;">r</td> <td style="text-align: center;">-</td> </tr> </table>								<b>TMP_COEF_SRCE</b>	-	r	-
<b>TMP_COEF_SRCE</b>	-										
r	-										

Field	Bits	Type	Description
TMP_COEF_SRCE	7	r	Temperature coefficients are based on: 0 - Internal temperature sensor (of ASIC) 1 - External temperature sensor (of pressure sensor MEMS element)
-	6:0	-	Reserved

## 9 Package Dimensions

The sensor package is a 8-pin plastic LGA 2.0 x 2.5 x 1.0 mm<sup>3</sup>, with 0.65 mm pitch.

Detailed information about a package, marking layout and tape and reel description can be found on the link:

[https://www.infineon.com/cms/packages/SMD\\_-\\_Surface\\_Mounted\\_Devices/P-PG-VLGA/P-PG-VLGA-08-01.html?\\_\\_locale=en](https://www.infineon.com/cms/packages/SMD_-_Surface_Mounted_Devices/P-PG-VLGA/P-PG-VLGA-08-01.html?__locale=en)

## 10 Package Handling

Further Information please refer to the attached “Digital Barometric Pressure Sensor\_ Package Handling” it describes the package handling and delivery format.

## Revision History

Major changes since previous revision

### Revision History

Reference	Description
0.1	First draft
0.2	Preliminary datasheet

**Revision History**

**Revision History**

<b>Reference</b>	<b>Description</b>
0.3	<p>Changes:</p> <ul style="list-style-type: none"> <li>• New formula for pressure compensation.</li> <li>• New formula for temperature compensation.</li> <li>• Changed compensation coefficient mapping in the Calibration Coefficient register.</li> <li>• Added temperature Coefficient Source register.</li> <li>• Added Known Issues list.</li> <li>• Minor layout changes in all the register descriptions.</li> <li>• Expanded test condition range for the absolute pressure accuracy specification.</li> </ul>
0.4	<p>Changes</p> <ul style="list-style-type: none"> <li>• Temperature accuracy</li> <li>• Update Known Issues list</li> <li>• Update Register Map and Register description</li> </ul>
0.5	<p>Changes</p> <ul style="list-style-type: none"> <li>• Update Register Map</li> <li>• Update Interrupt Status (INT_STS)</li> <li>• Update Coefficient Source</li> </ul>
0.6	<p>Changes</p> <ul style="list-style-type: none"> <li>• Update Feature</li> <li>• Typical Application updated</li> <li>• Operating range updated</li> <li>• Current consumption</li> <li>• Temperature data resolution</li> <li>• Pressure transfer function</li> <li>• Functional description</li> <li>• Measurement precision and rate</li> <li>• Functional description</li> <li>• Applications</li> <li>• Register map</li> <li>• Known issues list</li> </ul>
07	<p>Changes</p> <ul style="list-style-type: none"> <li>• Update table: Operating Range</li> <li>• Update: application circuit example</li> <li>• Update Register map, CFG_REG</li> <li>• Update Digital interface chapter</li> <li>• Update Package Dimensions</li> </ul>
08	<p>Changes</p> <ul style="list-style-type: none"> <li>• Update Digital interface: I2C interface read, autoincrement commands</li> <li>• Update: package dimensions chapter</li> <li>• Update Features, include RoHS information</li> <li>• Update Application Circuit Example</li> <li>• Update Register description TMP_CFG and MEAS_CFG</li> <li>• Add Package Handling</li> </ul>

---

**Known Issues List**

---

**Revision History**

<b>Reference</b>	<b>Description</b>
09	Changes <ul style="list-style-type: none"><li>• Typical applications</li><li>• Operating range</li><li>• Absolute Maximum Ratings</li><li>• Pressure Transfer Function</li><li>• Applications, IIR filtering</li></ul>

---

**Known Issues List**

---

**Known Issues**

<b>Product and Revision ID</b>	<b>Description</b>



## Trademarks of Infineon Technologies AG

$\mu$ HVIC™,  $\mu$ IPM™,  $\mu$ PFC™, AU-ConvertIR™, AURIX™, C166™, CanPAK™, CIPOS™, CIPURSE™, CoolDP™, CoolGaN™, COOLiR™, CoolMOS™, CoolSET™, CoolSiC™, DAVE™, DI-POL™, DirectFET™, DrBlade™, EasyPIM™, EconoBRIDGE™, EconoDUAL™, EconoPACK™, EconoPIM™, EiceDRIVER™, eupec™, FCOS™, GaNpowIR™, HEXFET™, HITFET™, HybridPACK™, iMOTION™, IRAM™, ISOFACE™, IsoPACK™, LEDriviR™, LITIX™, MIPAQ™, ModSTACK™, my-d™, NovalithIC™, OPTIGA™, OptiMOS™, ORIGA™, PowIRaudio™, PowIRstage™, PrimePACK™, PrimeSTACK™, PROFET™, PRO-SIL™, RASIC™, REAL3™, SmartLEWIS™, SOLID FLASH™, SPOC™, StrongIRFET™, SuplIRBuck™, TEMPFET™, TRENCHSTOP™, TriCore™, UHVIC™, XHP™, XMC™.

Trademarks Update 2015-12-22

## Other Trademarks

All referenced product or service names and trademarks are the property of their respective owners.

**Edition 2016-09-05**

**Published by**  
**Infineon Technologies AG**  
**81726 Munich, Germany**

**© 2016 Infineon Technologies AG**  
**All Rights Reserved.**

**Do you have a question about any aspect of this document?**  
**Email: [erratum@infineon.com](mailto:erratum@infineon.com)**

**Document reference**  
**IFX-sch1406115644540**

## IMPORTANT NOTICE

The information given in this document shall in no event be regarded as a guarantee of conditions or characteristics ("Beschaffenhheitsgarantie").

With respect to any examples, hints or any typical values stated herein and/or any information regarding the application of the product, Infineon Technologies hereby disclaims any and all warranties and liabilities of any kind, including without limitation warranties of non-infringement of intellectual property rights of any third party.

In addition, any information given in this document is subject to customer's compliance with its obligations stated in this document and any applicable legal requirements, norms and standards concerning customer's products and any use of the product of Infineon Technologies in customer's applications.

The data contained in this document is exclusively intended for technically trained staff. It is the responsibility of customer's technical departments to evaluate the suitability of the product for the intended application and the completeness of the product information given in this document with respect to such application.

## WARNINGS

Due to technical requirements products may contain dangerous substances. For information on the types in question please contact your nearest Infineon Technologies office.

Except as otherwise explicitly approved by Infineon Technologies in a written document signed by authorized representatives of Infineon Technologies, Infineon Technologies' products may not be used in any applications where a failure of the product or any consequences of the use thereof can reasonably be expected to result in personal injury