

MOSFET

OptiMOS™ 5 Power-Transistor, 100 V

Features

- Ideal for high frequency switching and sync. rec.
- Excellent gate charge x $R_{DS(on)}$ product (FOM)
- Very low on-resistance $R_{DS(on)}$
- N-channel, normal level
- 100% avalanche tested
- Pb-free plating; RoHS compliant
- Qualified according to JEDEC¹⁾ for target applications
- Halogen-free according to IEC61249-2-21

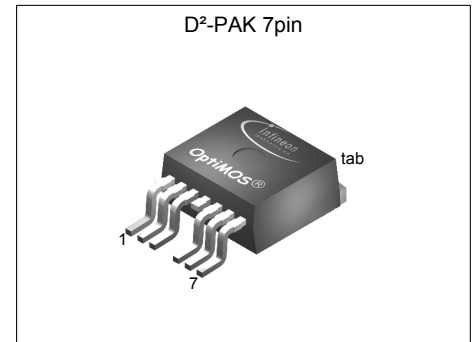
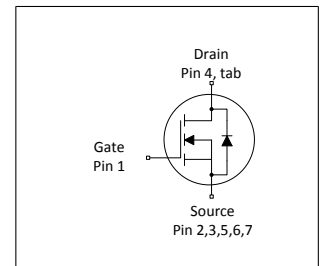

Table 1 Key Performance Parameters

| Parameter | Value | Unit |
|-------------------------|-------|------------|
| V_{DS} | 100 | V |
| $R_{DS(on),max}$ | 2.4 | m Ω |
| I_D (silicon limited) | 217 | A |
| I_D (package limited) | 180 | A |
| Q_{oss} | 142 | nC |
| $Q_G(0V..10V)$ | 111 | nC |



| Type / Ordering Code | Package | Marking | Related Links |
|----------------------|------------|----------|---------------|
| IPB024N10N5 | PG-TO263-7 | 024N10N5 | - |

¹⁾ J-STD20 and JESD22

Table of Contents

| | |
|---|----|
| Description | 1 |
| Maximum ratings | 3 |
| Thermal characteristics | 3 |
| Electrical characteristics | 4 |
| Electrical characteristics diagrams | 6 |
| Package Outlines | 10 |
| Revision History | 11 |
| Trademarks | 11 |
| Disclaimer | 11 |

1 Maximum ratings

at $T_A=25\text{ °C}$, unless otherwise specified

Table 2 Maximum ratings

| Parameter | Symbol | Values | | | Unit | Note / Test Condition |
|------------------------------------|-------------------|--------|------|------------|------|---|
| | | Min. | Typ. | Max. | | |
| Continuous drain current | I_D | - | - | 180 157 | A | $T_C=25\text{ °C}$ $T_C=100\text{ °C}$ |
| Pulsed drain current ¹⁾ | $I_{D,pulse}$ | - | - | 720 | A | $T_C=25\text{ °C}$ |
| Avalanche energy, single pulse | E_{AS} | - | - | 502 | mJ | $I_D=100\text{ A}$, $R_{GS}=25\text{ }\Omega$ |
| Gate source voltage | V_{GS} | -20 | - | 20 | V | - |
| Power dissipation | P_{tot} | - | - | 250 | W | $T_C=25\text{ °C}$ |
| Operating and storage temperature | T_j , T_{stg} | -55 | - | 175 | °C | IEC climatic category; DIN IEC 68-1: 55/175/56 |

2 Thermal characteristics

Table 3 Thermal characteristics

| Parameter | Symbol | Values | | | Unit | Note / Test Condition |
|--|------------|--------|------|------|------|-----------------------|
| | | Min. | Typ. | Max. | | |
| Thermal resistance, junction - case | R_{thJC} | - | 0.4 | 0.6 | K/W | - |
| Thermal resistance, junction - ambient, minimal footprint | R_{thJA} | - | - | 62 | K/W | - |
| Thermal resistance, junction - ambient, 6 cm ² cooling area ²⁾ | R_{thJA} | - | - | 40 | K/W | - |
| Soldering temperature and reflow soldering is allowed | T_{sold} | - | - | 260 | °C | reflow MSL1 |

¹⁾ see Diagram 3

²⁾ Device on 40 mm x 40 mm x 1.5 mm epoxy PCB FR4 with 6 cm² (one layer, 70 µm thick) copper area for drain connection. PCB is vertical in still air.

3 Electrical characteristics

Table 4 Static characteristics

| Parameter | Symbol | Values | | | Unit | Note / Test Condition |
|----------------------------------|---------------|--------|------------|------------|---------------|---|
| | | Min. | Typ. | Max. | | |
| Drain-source breakdown voltage | $V_{(BR)DSS}$ | 100 | - | - | V | $V_{GS}=0\text{ V}$, $I_D=1\text{ mA}$ |
| Gate threshold voltage | $V_{GS(th)}$ | 2.2 | 3.0 | 3.8 | V | $V_{DS}=V_{GS}$, $I_D=183\text{ }\mu\text{A}$ |
| Zero gate voltage drain current | I_{DSS} | - | 0.1 10 | 5 100 | μA | $V_{DS}=100\text{ V}$, $V_{GS}=0\text{ V}$, $T_j=25\text{ }^\circ\text{C}$ $V_{DS}=100\text{ V}$, $V_{GS}=0\text{ V}$, $T_j=125\text{ }^\circ\text{C}$ |
| Gate-source leakage current | I_{GSS} | - | 1 | 100 | nA | $V_{GS}=20\text{ V}$, $V_{DS}=0\text{ V}$ |
| Drain-source on-state resistance | $R_{DS(on)}$ | - | 2.0 2.4 | 2.4 3.2 | m Ω | $V_{GS}=10\text{ V}$, $I_D=90\text{ A}$ $V_{GS}=6\text{ V}$, $I_D=45\text{ A}$ |
| Gate resistance ¹⁾ | R_G | - | 1.2 | 1.8 | Ω | - |
| Transconductance | g_{fs} | 105 | 210 | - | S | $ V_{DS} >2 I_D R_{DS(on)max}$, $I_D=90\text{ A}$ |

Table 5 Dynamic characteristics¹⁾

| Parameter | Symbol | Values | | | Unit | Note / Test Condition |
|------------------------------|--------------|--------|------|-------|------|--|
| | | Min. | Typ. | Max. | | |
| Input capacitance | C_{iss} | - | 7870 | 10200 | pF | $V_{GS}=0\text{ V}$, $V_{DS}=50\text{ V}$, $f=1\text{ MHz}$ |
| Output capacitance | C_{oss} | - | 1200 | 1560 | pF | $V_{GS}=0\text{ V}$, $V_{DS}=50\text{ V}$, $f=1\text{ MHz}$ |
| Reverse transfer capacitance | C_{rss} | - | 53 | 93 | pF | $V_{GS}=0\text{ V}$, $V_{DS}=50\text{ V}$, $f=1\text{ MHz}$ |
| Turn-on delay time | $t_{d(on)}$ | - | 20 | - | ns | $V_{DD}=50\text{ V}$, $V_{GS}=10\text{ V}$, $I_D=90\text{ A}$, $R_{G,ext}=1.6\text{ }\Omega$ |
| Rise time | t_r | - | 12 | - | ns | $V_{DD}=50\text{ V}$, $V_{GS}=10\text{ V}$, $I_D=90\text{ A}$, $R_{G,ext}=1.6\text{ }\Omega$ |
| Turn-off delay time | $t_{d(off)}$ | - | 42 | - | ns | $V_{DD}=50\text{ V}$, $V_{GS}=10\text{ V}$, $I_D=90\text{ A}$, $R_{G,ext}=1.6\text{ }\Omega$ |
| Fall time | t_f | - | 13 | - | ns | $V_{DD}=50\text{ V}$, $V_{GS}=10\text{ V}$, $I_D=90\text{ A}$, $R_{G,ext}=1.6\text{ }\Omega$ |

Table 6 Gate charge characteristics²⁾

| Parameter | Symbol | Values | | | Unit | Note / Test Condition |
|------------------------------------|---------------|--------|------|------|------|---|
| | | Min. | Typ. | Max. | | |
| Gate to source charge | Q_{gs} | - | 36 | - | nC | $V_{DD}=50\text{ V}$, $I_D=90\text{ A}$, $V_{GS}=0\text{ to }10\text{ V}$ |
| Gate to drain charge ¹⁾ | Q_{gd} | - | 23 | 34 | nC | $V_{DD}=50\text{ V}$, $I_D=90\text{ A}$, $V_{GS}=0\text{ to }10\text{ V}$ |
| Switching charge | Q_{sw} | - | 35 | - | nC | $V_{DD}=50\text{ V}$, $I_D=90\text{ A}$, $V_{GS}=0\text{ to }10\text{ V}$ |
| Gate charge total ¹⁾ | Q_g | - | 111 | 138 | nC | $V_{DD}=50\text{ V}$, $I_D=90\text{ A}$, $V_{GS}=0\text{ to }10\text{ V}$ |
| Gate plateau voltage | $V_{plateau}$ | - | 4.6 | - | V | $V_{DD}=50\text{ V}$, $I_D=90\text{ A}$, $V_{GS}=0\text{ to }10\text{ V}$ |
| Output charge ¹⁾ | Q_{oss} | - | 142 | 188 | nC | $V_{DD}=50\text{ V}$, $V_{GS}=0\text{ V}$ |

¹⁾ Defined by design. Not subject to production test.

²⁾ See "Gate charge waveforms" for parameter definition

Table 7 Reverse diode

| Parameter | Symbol | Values | | | Unit | Note / Test Condition |
|---------------------------------------|---------------|--------|------|------|------|---|
| | | Min. | Typ. | Max. | | |
| Diode continuous forward current | I_S | - | - | 180 | A | $T_C=25\text{ °C}$ |
| Diode pulse current | $I_{S,pulse}$ | - | - | 720 | A | $T_C=25\text{ °C}$ |
| Diode forward voltage | V_{SD} | - | 0.9 | 1.2 | V | $V_{GS}=0\text{ V}, I_F=90\text{ A}, T_j=25\text{ °C}$ |
| Reverse recovery time ¹⁾ | t_{rr} | - | 65 | 130 | ns | $V_R=50\text{ V}, I_F=90, di_F/dt=100\text{ A}/\mu\text{s}$ |
| Reverse recovery charge ¹⁾ | Q_{rr} | - | 123 | 246 | nC | $V_R=50\text{ V}, I_F=90, di_F/dt=100\text{ A}/\mu\text{s}$ |

¹⁾ Defined by design. Not subject to production test.

4 Electrical characteristics diagrams

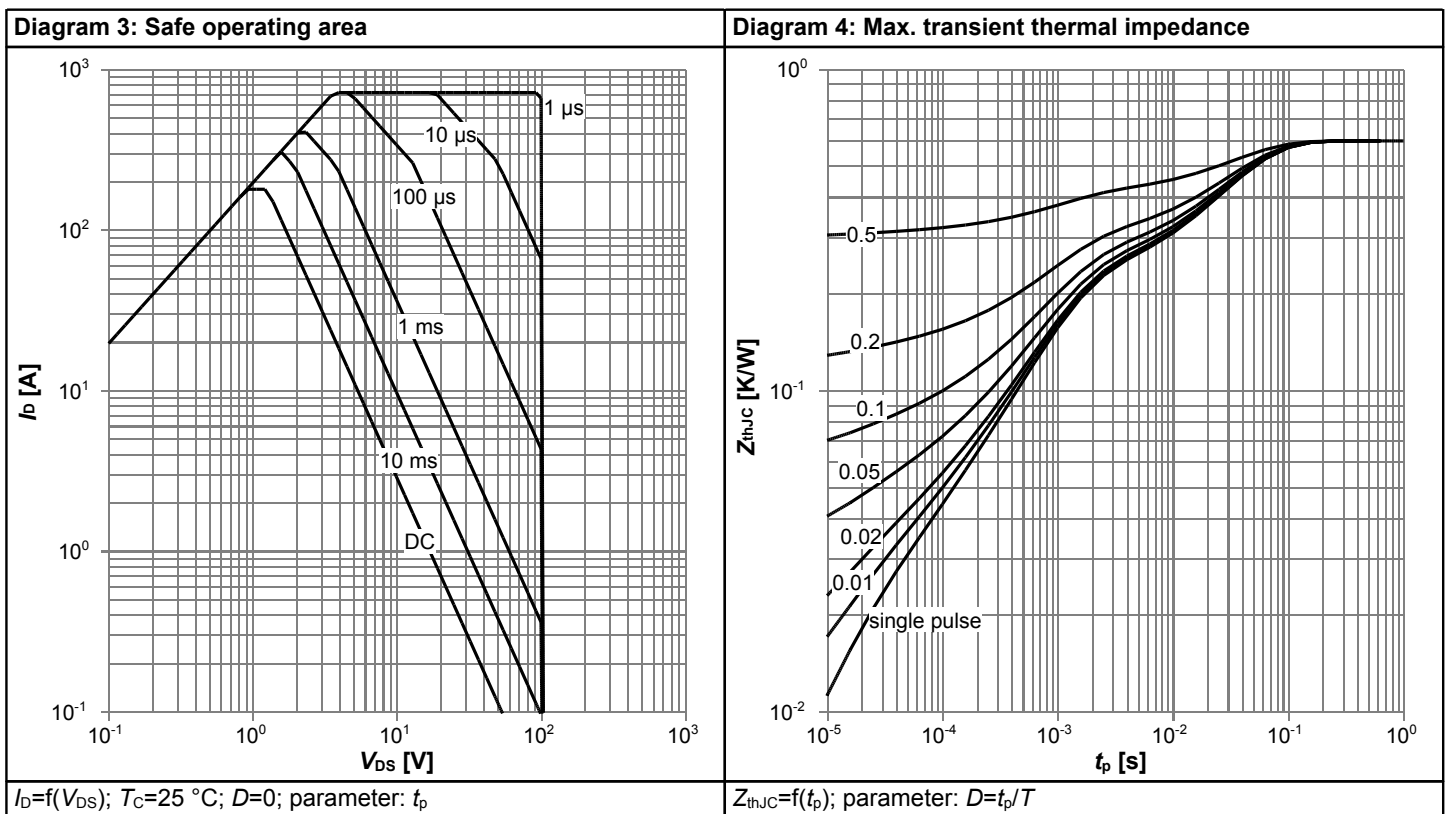
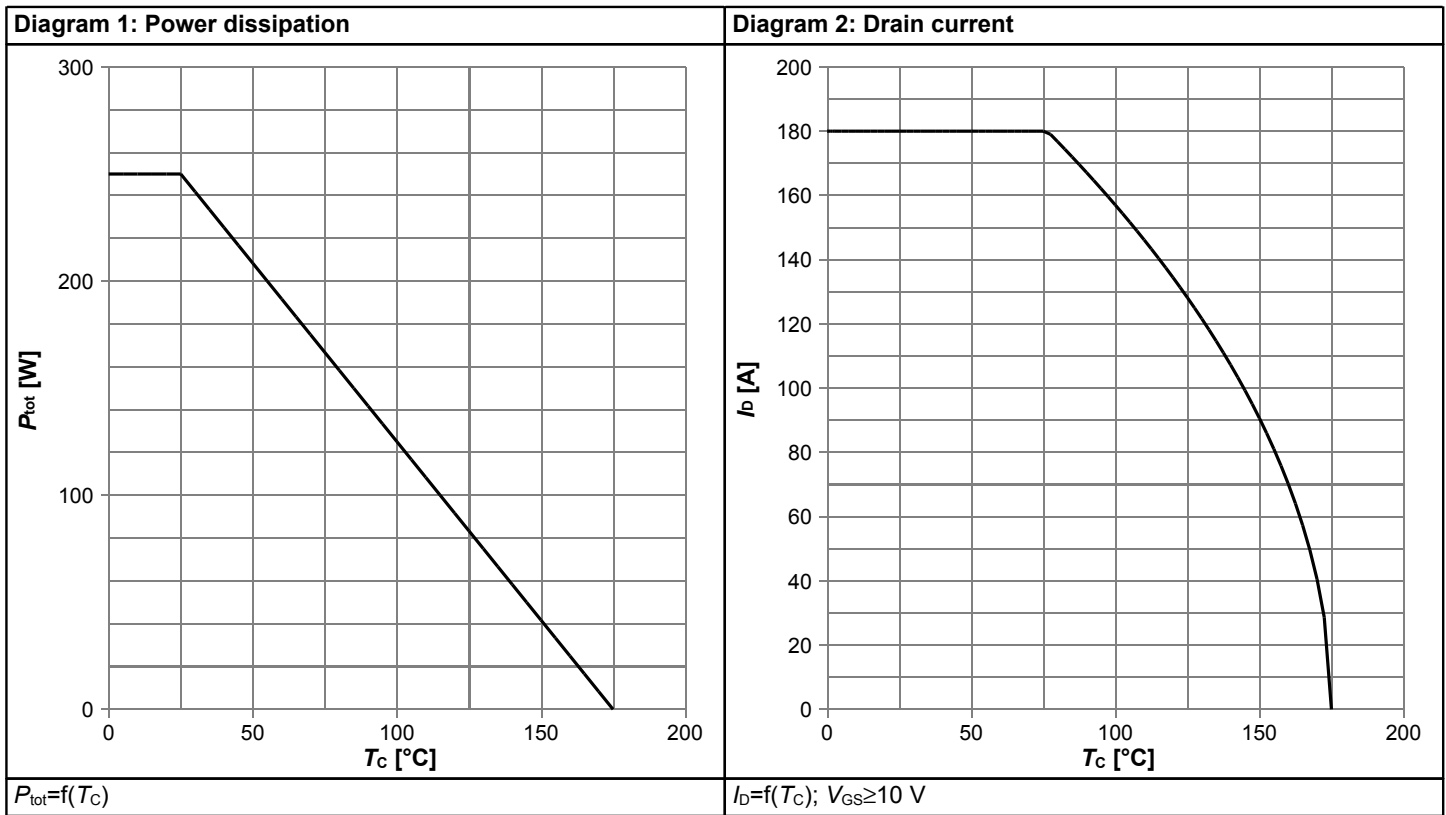
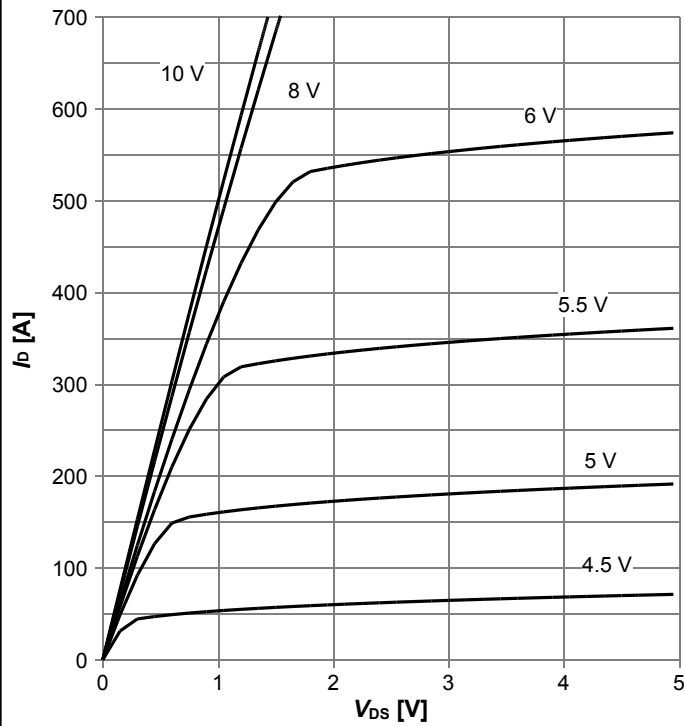
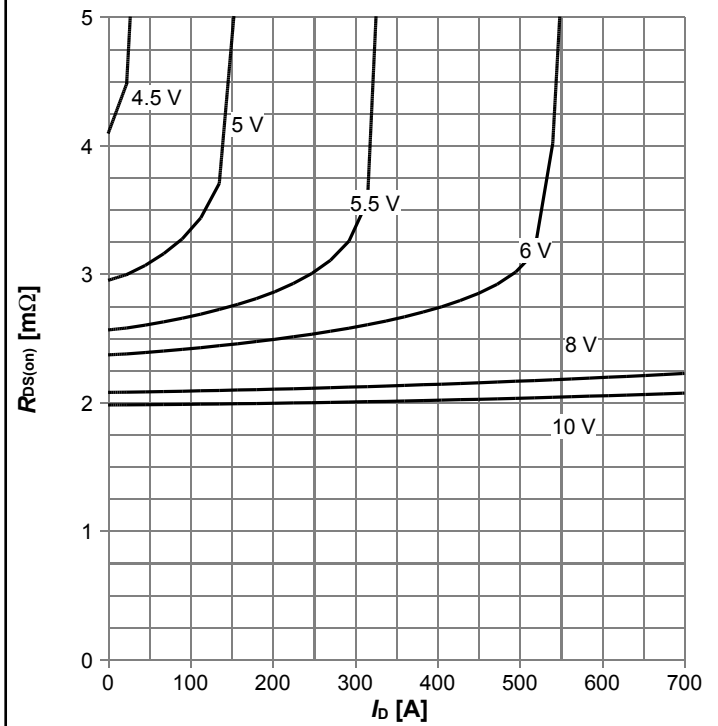

Diagram 5: Typ. output characteristics



$I_D = f(V_{DS}); T_j = 25^\circ\text{C};$ parameter: V_{GS}

Diagram 6: Typ. drain-source on resistance



$R_{DS(on)} = f(I_D); T_j = 25^\circ\text{C};$ parameter: V_{GS}

Diagram 7: Typ. transfer characteristics

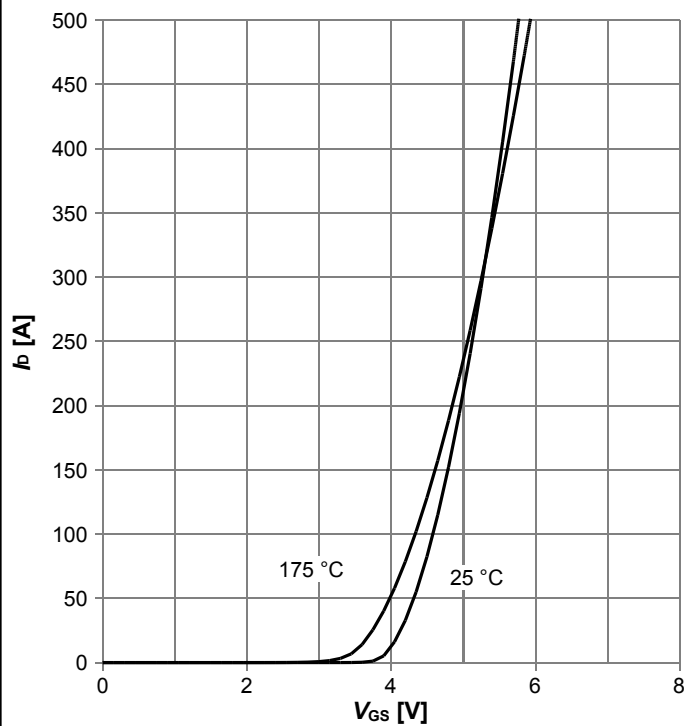

$I_D = f(V_{GS}); |V_{DS}| > 2|I_D|R_{DS(on)max};$ parameter: T_j

Diagram 8: Typ. forward transconductance

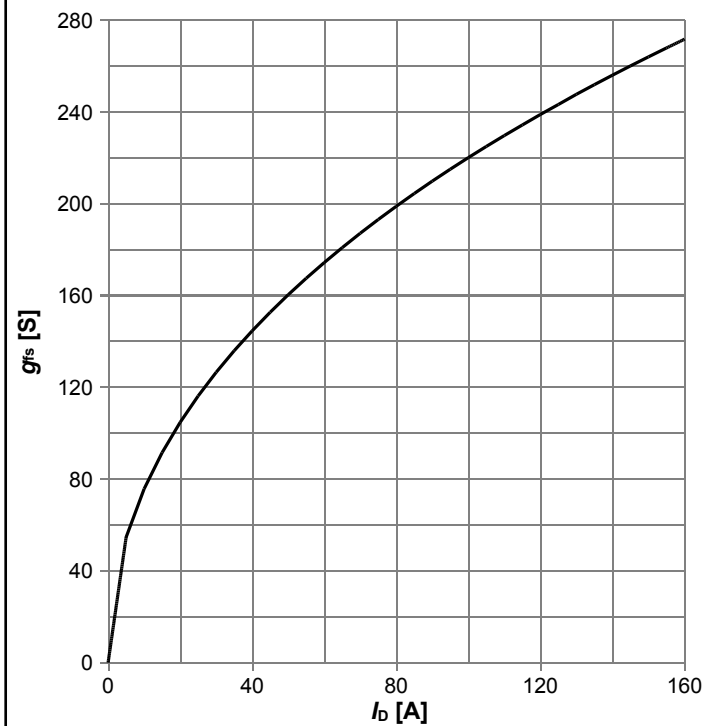

$g_{fs} = f(I_D); T_j = 25^\circ\text{C}$

Diagram 9: Drain-source on-state resistance

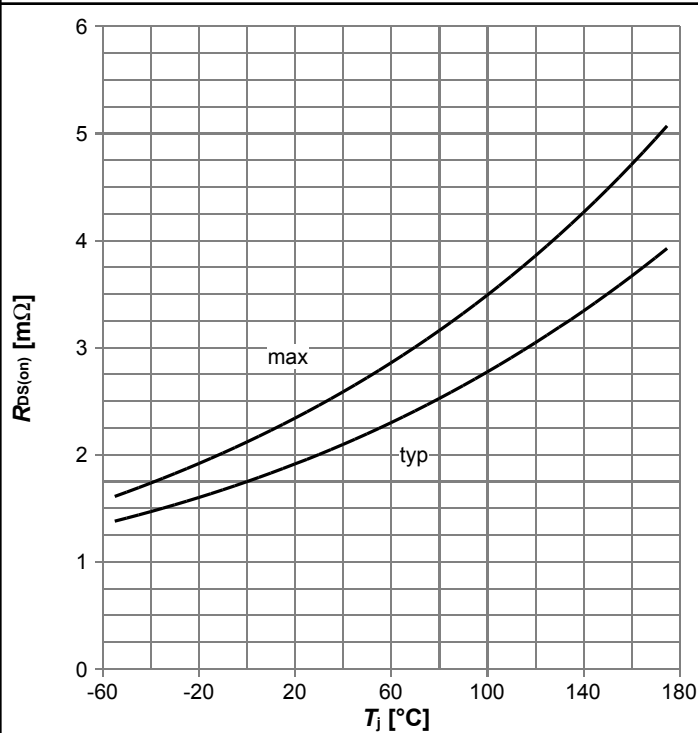

$R_{DS(on)}=f(T_j)$; $I_D=90\text{ A}$; $V_{GS}=10\text{ V}$

Diagram 10: Typ. gate threshold voltage

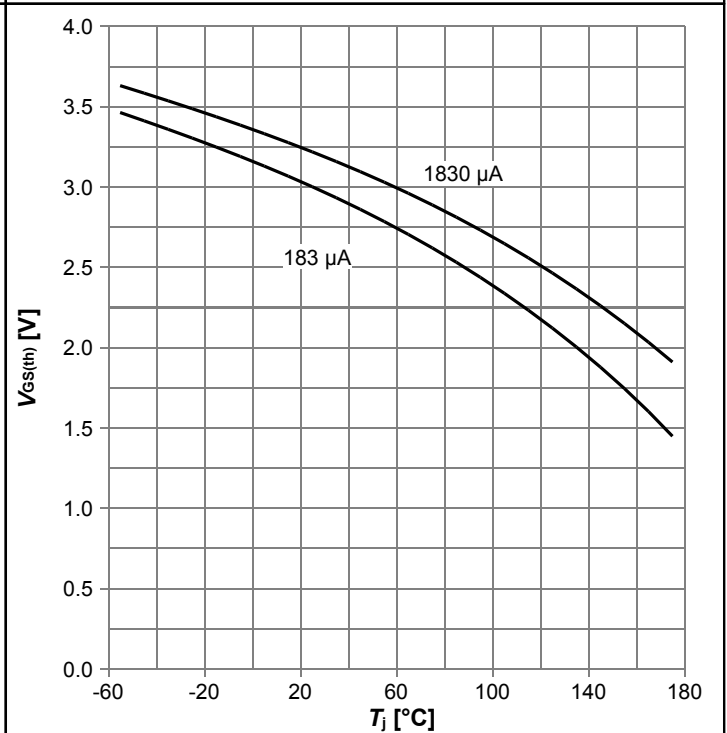

$V_{GS(th)}=f(T_j)$; $V_{GS}=V_{DS}$; parameter: I_D

Diagram 11: Typ. capacitances

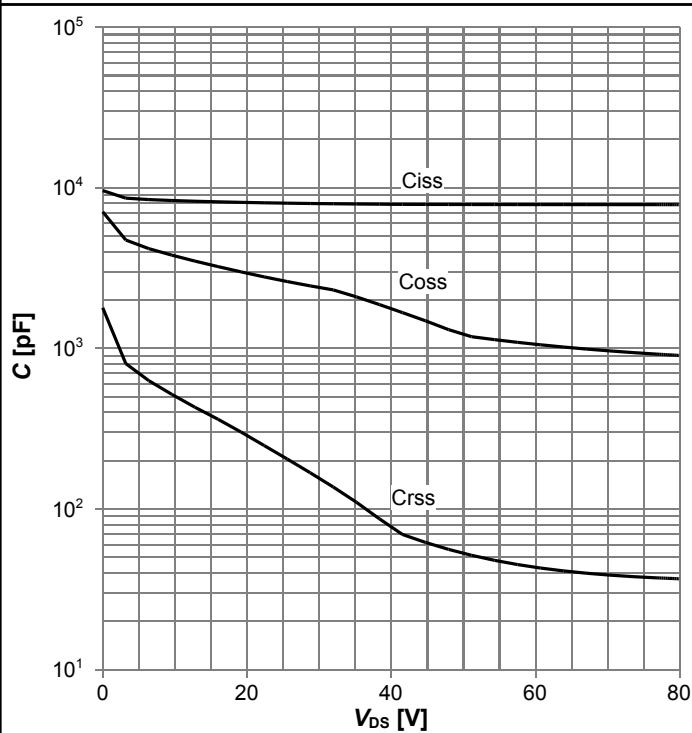

$C=f(V_{DS})$; $V_{GS}=0\text{ V}$; $f=1\text{ MHz}$

Diagram 12: Forward characteristics of reverse diode

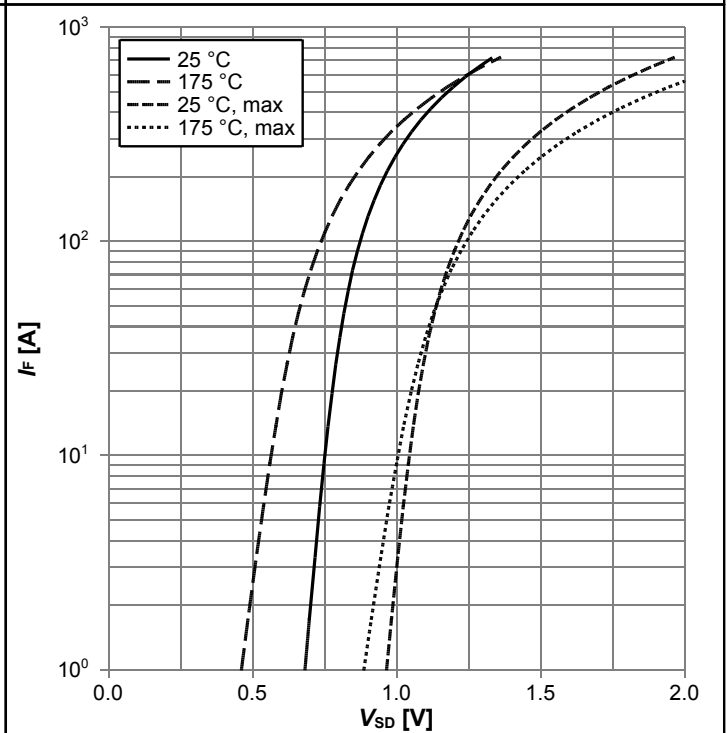

$I_F=f(V_{SD})$; parameter: T_j

Diagram 13: Avalanche characteristics

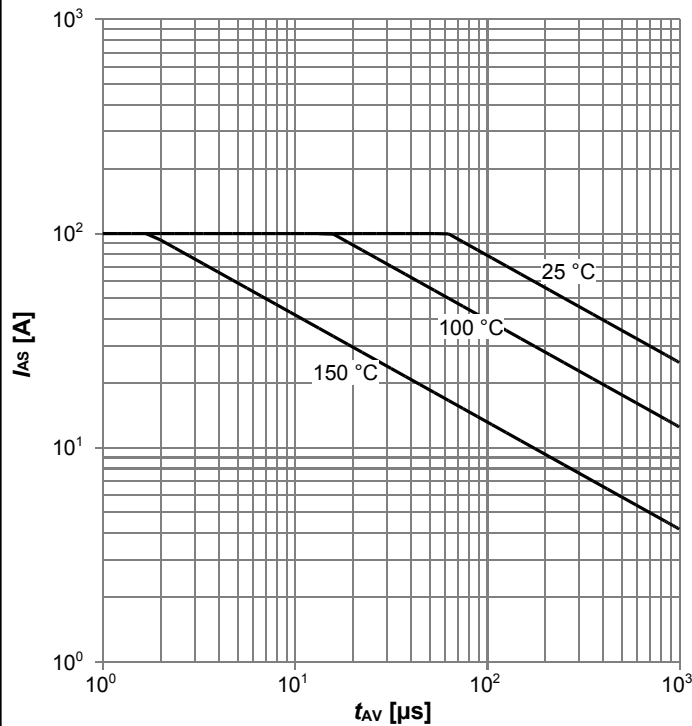

$I_{AS}=f(t_{AV}); R_{GS}=25 \Omega$; parameter: $T_{j(start)}$

Diagram 14: Typ. gate charge

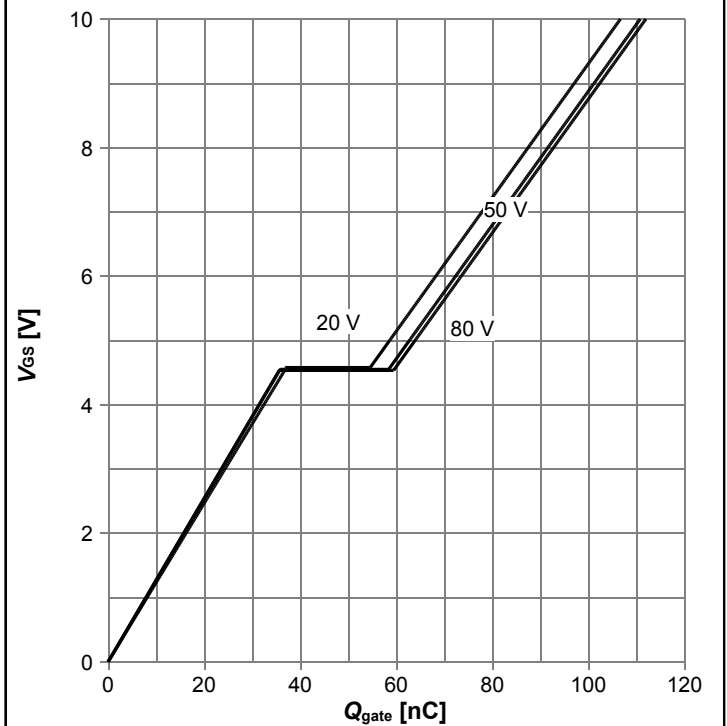

$V_{GS}=f(Q_{gate}); I_D=90$ A pulsed; parameter: V_{DD}

Diagram 15: Drain-source breakdown voltage

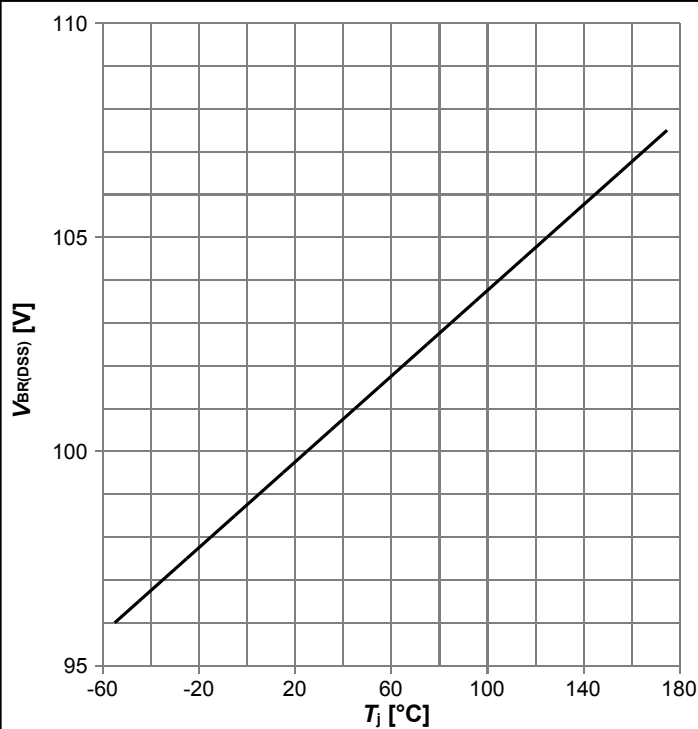

$V_{BR(DSS)}=f(T_j); I_D=1$ mA

Gate charge waveforms



5 Package Outlines

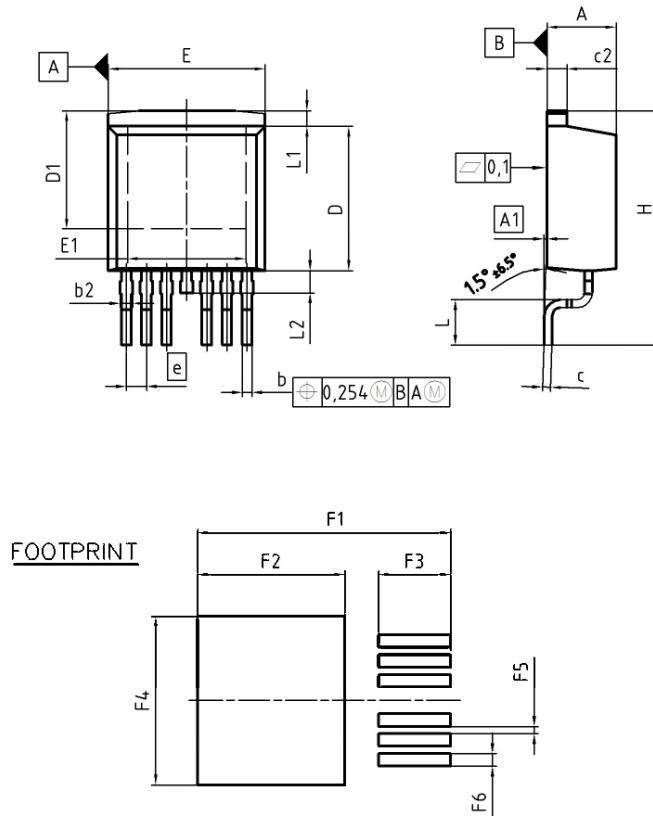

| DIM | MILLIMETERS | | INCHES | |
|-----|-------------|-------|--------|-------|
| | MIN | MAX | MIN | MAX |
| A | 4.30 | 4.57 | 0.169 | 0.180 |
| A1 | 0.00 | 0.25 | 0.000 | 0.010 |
| b | 0.50 | 0.70 | 0.020 | 0.028 |
| b2 | 0.50 | 1.00 | 0.020 | 0.039 |
| c | 0.33 | 0.65 | 0.013 | 0.026 |
| c2 | 1.17 | 1.40 | 0.046 | 0.055 |
| D | 8.51 | 9.45 | 0.335 | 0.372 |
| D1 | 6.90 | 7.90 | 0.272 | 0.311 |
| E | 9.80 | 10.31 | 0.386 | 0.406 |
| E1 | 6.50 | 8.60 | 0.256 | 0.339 |
| e | 1.27 | | 0.050 | |
| N | 6 | | 6 | |
| H | 14.61 | 15.88 | 0.575 | 0.625 |
| L | 2.29 | 3.00 | 0.090 | 0.118 |
| L1 | 0.70 | 1.60 | 0.028 | 0.063 |
| L2 | 1.00 | 1.78 | 0.039 | 0.070 |
| F1 | 16.05 | 16.25 | 0.632 | 0.640 |
| F2 | 9.30 | 9.50 | 0.366 | 0.374 |
| F3 | 4.50 | 4.70 | 0.177 | 0.185 |
| F4 | 10.70 | 10.90 | 0.421 | 0.429 |
| F5 | 0.37 | 0.57 | 0.015 | 0.022 |
| F6 | 0.70 | 0.90 | 0.028 | 0.035 |

DOCUMENT NO.
Z8B00134765

SCALE

EUROPEAN PROJECTION

ISSUE DATE
05-11-2007

REVISION
01

Figure 1 Outline PG-TO263-7, dimensions in mm/inches

Revision History

IPB024N10N5

Revision: 2016-10-03, Rev. 2.1

Previous Revision

| Revision | Date | Subjects (major changes since last revision) |
|----------|------------|--|
| 2.0 | 2016-04-11 | Release of final version |
| 2.1 | 2016-10-03 | Update Avalanche Energy |

Trademarks of Infineon Technologies AG

AURIX™, C166™, CanPAK™, CIPOS™, CoolGaN™, CoolMOS™, CoolSET™, CoolSiC™, CORECONTROL™, CROSSAVE™, DAVE™, DI-POL™, DrBlade™, EasyPIM™, EconoBRIDGE™, EconoDUAL™, EconoPACK™, EconoPIM™, EiceDRIVER™, eupec™, FCOS™, HITFET™, HybridPACK™, Infineon™, ISOFACE™, IsoPACK™, i-Wafer™, MIPAQ™, ModSTACK™, my-d™, NovalithIC™, OmniTune™, OPTIGA™, OptiMOS™, ORIGA™, POWERCODE™, PRIMARION™, PrimePACK™, PrimeSTACK™, PROFET™, PRO-SIL™, RASIC™, REAL3™, ReverSave™, SatRIC™, SIEGET™, SiPMOS™, SmartLEWIS™, SOLID FLASH™, SPOC™, TEMPFET™, thinQ!™, TRENCHSTOP™, TriCore™.

Trademarks updated August 2015

Other Trademarks

All referenced product or service names and trademarks are the property of their respective owners.

We Listen to Your Comments

Any information within this document that you feel is wrong, unclear or missing at all? Your feedback will help us to continuously improve the quality of this document. Please send your proposal (including a reference to this document) to:

erratum@infineon.com

Published by
Infineon Technologies AG
81726 München, Germany
© 2016 Infineon Technologies AG
All Rights Reserved.

Legal Disclaimer

The information given in this document shall in no event be regarded as a guarantee of conditions or characteristics ("Beschaffenheitsgarantie").

With respect to any examples, hints or any typical values stated herein and/or any information regarding the application of the product, Infineon Technologies hereby disclaims any and all warranties and liabilities of any kind, including without limitation warranties of non-infringement of intellectual property rights of any third party.

In addition, any information given in this document is subject to customer's compliance with its obligations stated in this document and any applicable legal requirements, norms and standards concerning customer's products and any use of the product of Infineon Technologies in customer's applications.

The data contained in this document is exclusively intended for technically trained staff. It is the responsibility of customer's technical departments to evaluate the suitability of the product for the intended application and the completeness of the product information given in this document with respect to such application.

Information

For further information on technology, delivery terms and conditions and prices please contact your nearest Infineon Technologies Office (www.infineon.com).

Warnings

Due to technical requirements, components may contain dangerous substances. For information on the types in question, please contact the nearest Infineon Technologies Office.

The Infineon Technologies component described in this Data Sheet may be used in life-support devices or systems and/or automotive, aviation and aerospace applications or systems only with the express written approval of Infineon Technologies, if a failure of such components can reasonably be expected to cause the failure of that life-support, automotive, aviation and aerospace device or system or to affect the safety or effectiveness of that device or system. Life support devices or systems are intended to be implanted in the human body or to support and/or maintain and sustain and/or protect human life. If they fail, it is reasonable to assume that the health of the user or other persons may be endangered.