

WARP2 SERIES IGBT WITH  
ULTRAFAST SOFT RECOVERY DIODE

**Applications**

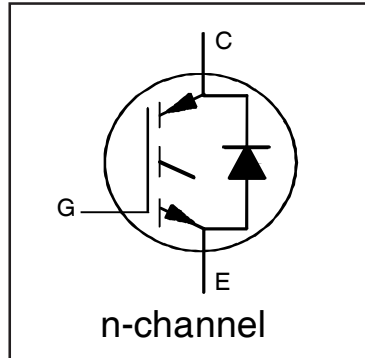
- Telecom and Server SMPS
- PFC and ZVS SMPS Circuits
- Uninterruptable Power Supplies
- Consumer Electronics Power Supplies
- Lead-Free

**Features**

- NPT Technology, Positive Temperature Coefficient
- Lower  $V_{CE(SAT)}$
- Lower Parasitic Capacitances
- Minimal Tail Current
- HEXFRED Ultra Fast Soft-Recovery Co-Pack Diode
- Tighter Distribution of Parameters
- Higher Reliability

**Benefits**

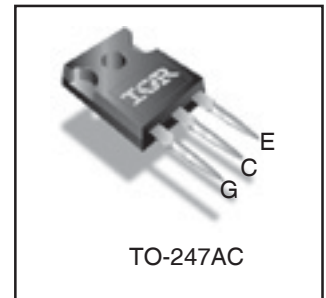
- Parallel Operation for Higher Current Applications
- Lower Conduction Losses and Switching Losses
- Higher Switching Frequency up to 150kHz



$V_{CES} = 600V$   
 $V_{CE(on)} \text{ typ.} = 2.00V$   
 @  $V_{GE} = 15V$   $I_C = 33A$

**Equivalent MOSFET Parameters<sup>①</sup>**

$R_{CE(on)} \text{ typ.} = 61m\Omega$   
 $I_D$  (FET equivalent) = 50A



**Absolute Maximum Ratings**

	Parameter	Max.	Units
$V_{CES}$	Collector-to-Emitter Voltage	600	V
$I_C$ @ $T_C = 25^\circ C$	Continuous Collector Current	75	A
$I_C$ @ $T_C = 100^\circ C$	Continuous Collector Current	45	
$I_{CM}$	Pulse Collector Current (Ref. Fig. C.T.4)	150	
$I_{LM}$	Clamped Inductive Load Current <sup>②</sup>	150	
$I_F$ @ $T_C = 25^\circ C$	Diode Continuous Forward Current	40	
$I_F$ @ $T_C = 100^\circ C$	Diode Continuous Forward Current	15	
$I_{FRM}$	Maximum Repetitive Forward Current <sup>③</sup>	60	
$V_{GE}$	Gate-to-Emitter Voltage	$\pm 20$	
$P_D$ @ $T_C = 25^\circ C$	Maximum Power Dissipation	390	W
$P_D$ @ $T_C = 100^\circ C$	Maximum Power Dissipation	156	
$T_J$	Operating Junction and	-55 to +150	$^\circ C$
$T_{STG}$	Storage Temperature Range		
	Soldering Temperature for 10 sec.	300 (0.063 in. (1.6mm) from case)	
	Mounting Torque, 6-32 or M3 Screw	10 lbf-in (1.1 N-m)	

**Thermal Resistance**

	Parameter	Min.	Typ.	Max.	Units
$R_{\theta JC}$ (IGBT)	Thermal Resistance Junction-to-Case-(each IGBT)	—	—	0.32	$^\circ C/W$
$R_{\theta JC}$ (Diode)	Thermal Resistance Junction-to-Case-(each Diode)	—	—	1.7	
$R_{\theta CS}$	Thermal Resistance, Case-to-Sink (flat, greased surface)	—	0.24	—	
$R_{\theta JA}$	Thermal Resistance, Junction-to-Ambient (typical socket mount)	—	—	40	
	Weight	—	6.0 (0.21)	—	g (oz)

## Electrical Characteristics @ T<sub>J</sub> = 25°C (unless otherwise specified)

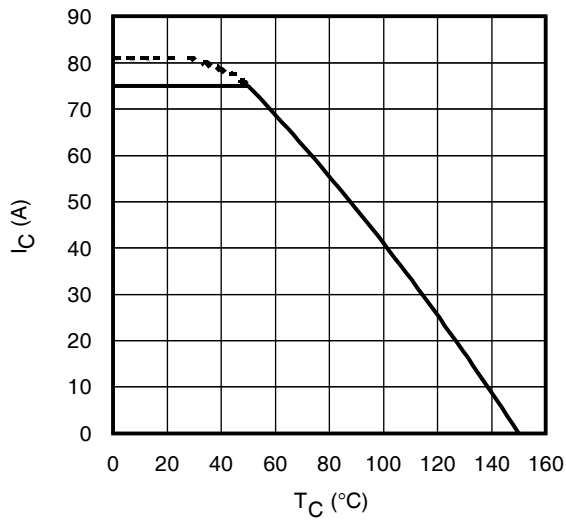
	Parameter	Min.	Typ.	Max.	Units	Conditions	Ref.Fig
V <sub>(BR)CES</sub>	Collector-to-Emitter Breakdown Voltage	600	—	—	V	V <sub>GE</sub> = 0V, I <sub>C</sub> = 500μA	
ΔV <sub>(BR)CES</sub> /ΔT <sub>J</sub>	Temperature Coeff. of Breakdown Voltage	—	0.31	—	V/°C	V <sub>GE</sub> = 0V, I <sub>C</sub> = 1mA (25°C-125°C)	
R <sub>G</sub>	Internal Gate Resistance	—	1.7	—	Ω	1MHz, Open Collector	
V <sub>CE(on)</sub>	Collector-to-Emitter Saturation Voltage	—	2.00	2.35	V	I <sub>C</sub> = 33A, V <sub>GE</sub> = 15V	4, 5,6,8,9
		—	2.45	2.85		I <sub>C</sub> = 50A, V <sub>GE</sub> = 15V	
		—	2.60	2.95		I <sub>C</sub> = 33A, V <sub>GE</sub> = 15V, T <sub>J</sub> = 125°C	
		—	3.20	3.60		I <sub>C</sub> = 50A, V <sub>GE</sub> = 15V, T <sub>J</sub> = 125°C	
V <sub>GE(th)</sub>	Gate Threshold Voltage	3.0	4.0	5.0	V	I <sub>C</sub> = 250μA	7,8,9
ΔV <sub>GE(th)</sub> /ΔT <sub>J</sub>	Threshold Voltage temp. coefficient	—	-10	—	mV/°C	V <sub>CE</sub> = V <sub>GE</sub> , I <sub>C</sub> = 1.0mA	
g <sub>fe</sub>	Forward Transconductance	—	41	—	S	V <sub>CE</sub> = 50V, I <sub>C</sub> = 33A, PW = 80μs	
I <sub>CES</sub>	Collector-to-Emitter Leakage Current	—	5.0	500	μA	V <sub>GE</sub> = 0V, V <sub>CE</sub> = 600V	
		—	1.0	—	mA	V <sub>GE</sub> = 0V, V <sub>CE</sub> = 600V, T <sub>J</sub> = 125°C	
V <sub>FM</sub>	Diode Forward Voltage Drop	—	1.30	1.70	V	I <sub>F</sub> = 15A, V <sub>GE</sub> = 0V	10
		—	1.20	1.60		I <sub>F</sub> = 15A, V <sub>GE</sub> = 0V, T <sub>J</sub> = 125°C	
I <sub>GES</sub>	Gate-to-Emitter Leakage Current	—	—	±100	nA	V <sub>GE</sub> = ±20V, V <sub>CE</sub> = 0V	

## Switching Characteristics @ T<sub>J</sub> = 25°C (unless otherwise specified)

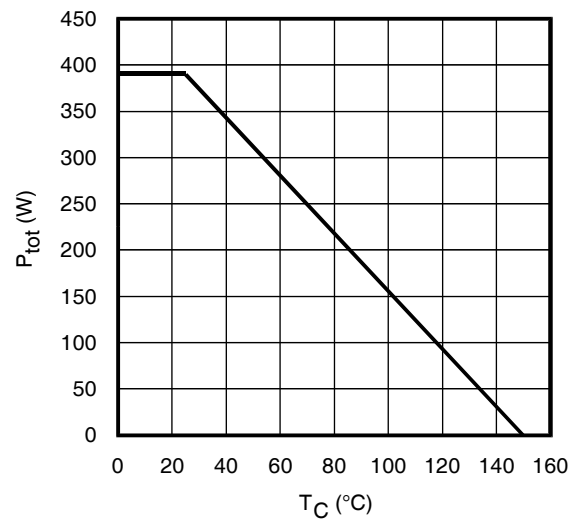
	Parameter	Min.	Typ.	Max.	Units	Conditions	Ref.Fig	
Q <sub>g</sub>	Total Gate Charge (turn-on)	—	205	308	nC	I <sub>C</sub> = 33A	17	
Q <sub>gc</sub>	Gate-to-Collector Charge (turn-on)	—	70	105		V <sub>CC</sub> = 400V	CT1	
Q <sub>ge</sub>	Gate-to-Emitter Charge (turn-on)	—	30	45		V <sub>GE</sub> = 15V		
E <sub>on</sub>	Turn-On Switching Loss	—	255	305	μJ	I <sub>C</sub> = 33A, V <sub>CC</sub> = 390V	CT3	
E <sub>off</sub>	Turn-Off Switching Loss	—	375	445		V <sub>GE</sub> = +15V, R <sub>G</sub> = 3.3Ω, L = 200μH		
E <sub>total</sub>	Total Switching Loss	—	630	750		T <sub>J</sub> = 25°C ④		
t <sub>d(on)</sub>	Turn-On delay time	—	30	40	ns	I <sub>C</sub> = 33A, V <sub>CC</sub> = 390V	CT3	
t <sub>r</sub>	Rise time	—	10	15		V <sub>GE</sub> = +15V, R <sub>G</sub> = 3.3Ω, L = 200μH		
t <sub>d(off)</sub>	Turn-Off delay time	—	130	150		T <sub>J</sub> = 25°C ④		
t <sub>f</sub>	Fall time	—	11	15				
E <sub>on</sub>	Turn-On Switching Loss	—	580	700		I <sub>C</sub> = 33A, V <sub>CC</sub> = 390V		CT3
E <sub>off</sub>	Turn-Off Switching Loss	—	480	550	V <sub>GE</sub> = +15V, R <sub>G</sub> = 3.3Ω, L = 200μH	11,13		
E <sub>total</sub>	Total Switching Loss	—	1060	1250	T <sub>J</sub> = 125°C ④	WF1,WF2		
t <sub>d(on)</sub>	Turn-On delay time	—	26	35	ns	I <sub>C</sub> = 33A, V <sub>CC</sub> = 390V	CT3	
t <sub>r</sub>	Rise time	—	13	20		V <sub>GE</sub> = +15V, R <sub>G</sub> = 3.3Ω, L = 200μH		
t <sub>d(off)</sub>	Turn-Off delay time	—	146	165		T <sub>J</sub> = 125°C ④		
t <sub>f</sub>	Fall time	—	15	20				
E <sub>on</sub>	Turn-On Switching Loss	—	580	700		I <sub>C</sub> = 33A, V <sub>CC</sub> = 390V		CT3
E <sub>off</sub>	Turn-Off Switching Loss	—	480	550	V <sub>GE</sub> = +15V, R <sub>G</sub> = 3.3Ω, L = 200μH	11,13		
E <sub>total</sub>	Total Switching Loss	—	1060	1250	T <sub>J</sub> = 125°C ④	WF1,WF2		
t <sub>d(on)</sub>	Turn-On delay time	—	26	35	pF	I <sub>C</sub> = 33A, V <sub>CC</sub> = 390V	CT3	
t <sub>r</sub>	Rise time	—	13	20		V <sub>GE</sub> = +15V, R <sub>G</sub> = 3.3Ω, L = 200μH		
t <sub>d(off)</sub>	Turn-Off delay time	—	146	165		T <sub>J</sub> = 125°C ④		
t <sub>f</sub>	Fall time	—	15	20				
E <sub>on</sub>	Turn-On Switching Loss	—	580	700		I <sub>C</sub> = 33A, V <sub>CC</sub> = 390V		CT3
E <sub>off</sub>	Turn-Off Switching Loss	—	480	550	V <sub>GE</sub> = +15V, R <sub>G</sub> = 3.3Ω, L = 200μH	11,13		
E <sub>total</sub>	Total Switching Loss	—	1060	1250	T <sub>J</sub> = 125°C ④	WF1,WF2		
C <sub>ies</sub>	Input Capacitance	—	3648	—	pF	V <sub>GE</sub> = 0V	16	
C <sub>oes</sub>	Output Capacitance	—	322	—		V <sub>CC</sub> = 30V		
C <sub>res</sub>	Reverse Transfer Capacitance	—	56	—		f = 1Mhz		
C <sub>oes eff.</sub>	Effective Output Capacitance (Time Related) ⑤	—	215	—		V <sub>GE</sub> = 0V, V <sub>CE</sub> = 0V to 480V		15
C <sub>oes eff. (ER)</sub>	Effective Output Capacitance (Energy Related) ⑤	—	163	—				
RBSOA	Reverse Bias Safe Operating Area	FULL SQUARE				T <sub>J</sub> = 150°C, I <sub>C</sub> = 150A V <sub>CC</sub> = 480V, V <sub>p</sub> = 600V R <sub>g</sub> = 22Ω, V <sub>GE</sub> = +15V to 0V	3 CT2	
t <sub>rr</sub>	Diode Reverse Recovery Time	—	42	60	ns	T <sub>J</sub> = 25°C I <sub>F</sub> = 15A, V <sub>R</sub> = 200V,	19	
		—	74	120		T <sub>J</sub> = 125°C di/dt = 200A/μs		
Q <sub>rr</sub>	Diode Reverse Recovery Charge	—	80	180	nC	T <sub>J</sub> = 25°C I <sub>F</sub> = 15A, V <sub>R</sub> = 200V,	21	
		—	220	600		T <sub>J</sub> = 125°C di/dt = 200A/μs		
I <sub>rr</sub>	Peak Reverse Recovery Current	—	4.0	6.0	A	T <sub>J</sub> = 25°C I <sub>F</sub> = 15A, V <sub>R</sub> = 200V,	19,20,21,22	
		—	6.5	10		T <sub>J</sub> = 125°C di/dt = 200A/μs		

### Notes:

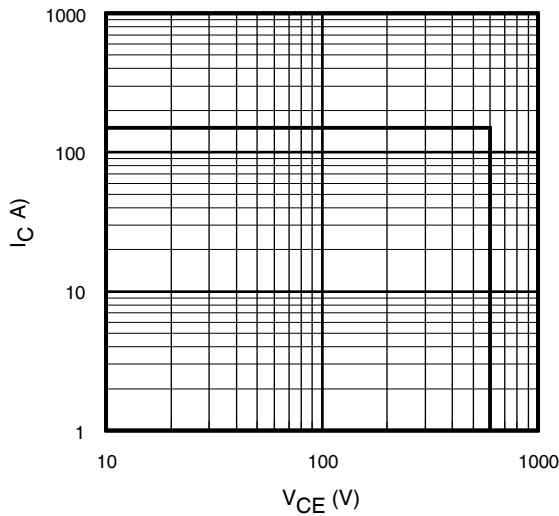
- ① R<sub>CE(on)</sub> typ. = equivalent on-resistance = V<sub>CE(on)</sub> typ. / I<sub>C</sub>, where V<sub>CE(on)</sub> typ. = 2.00V and I<sub>C</sub> = 33A. I<sub>D</sub> (FET Equivalent) is the equivalent MOSFET I<sub>D</sub> rating @ 25°C for applications up to 150kHz. These are provided for comparison purposes (only) with equivalent MOSFET solutions.
- ② V<sub>CC</sub> = 80% (V<sub>CES</sub>), V<sub>GE</sub> = 15V, L = 28 μH, R<sub>G</sub> = 22 Ω.
- ③ Pulse width limited by max. junction temperature.
- ④ Energy losses include "tail" and diode reverse recovery, Data generated with use of Diode 30ETH06.
- ⑤ C<sub>oes eff.</sub> is a fixed capacitance that gives the same charging time as C<sub>oes</sub> while V<sub>CE</sub> is rising from 0 to 80% V<sub>CES</sub>.  
C<sub>oes eff.(ER)</sub> is a fixed capacitance that stores the same energy as C<sub>oes</sub> while V<sub>CE</sub> is rising from 0 to 80% V<sub>CES</sub>.



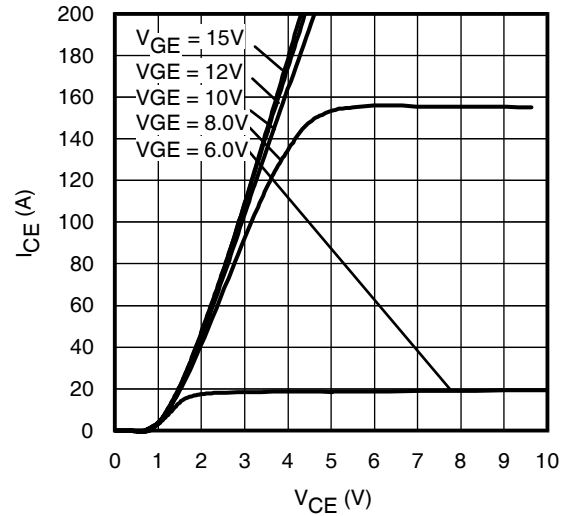
**Fig. 1** - Maximum DC Collector Current vs. Case Temperature



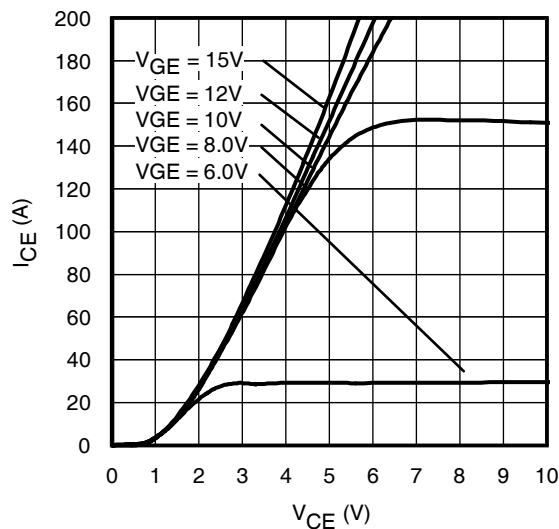
**Fig. 2** - Power Dissipation vs. Case Temperature



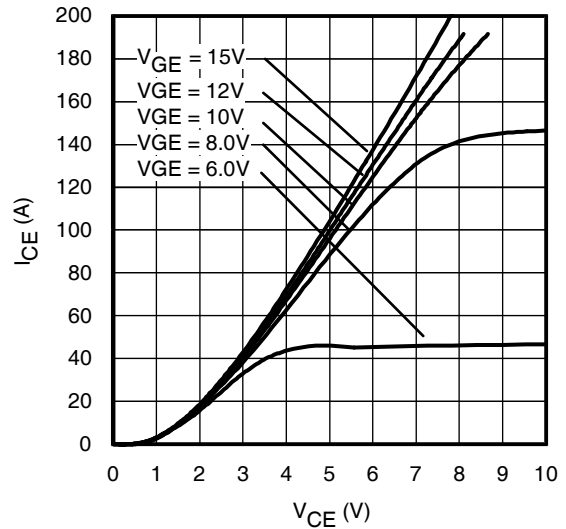
**Fig. 3** - Reverse Bias SOA  
 $T_J = 150^{\circ}C$ ;  $V_{GE} = 15V$



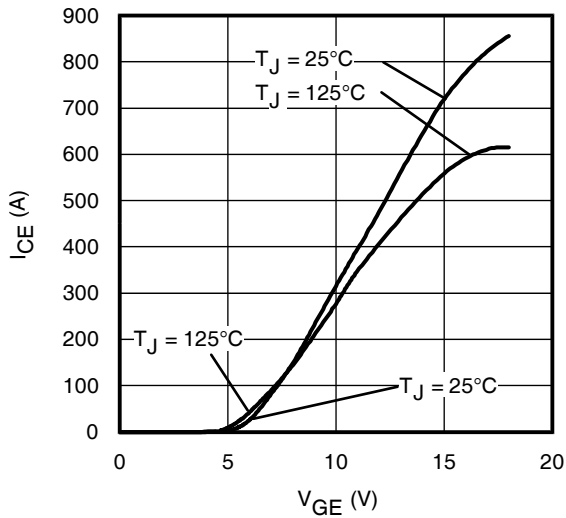
**Fig. 4** - Typ. IGBT Output Characteristics  
 $T_J = -40^{\circ}C$ ;  $t_p = 80\mu s$



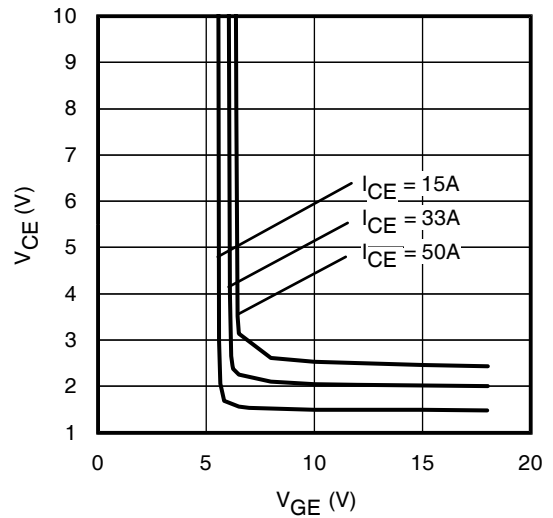
**Fig. 5** - Typ. IGBT Output Characteristics  
 $T_J = 25^{\circ}C$ ;  $t_p = 80\mu s$



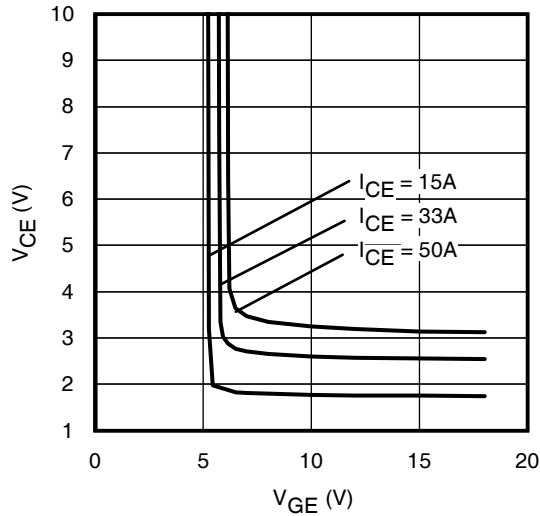
**Fig. 6** - Typ. IGBT Output Characteristics  
 $T_J = 125^{\circ}C$ ;  $t_p = 80\mu s$



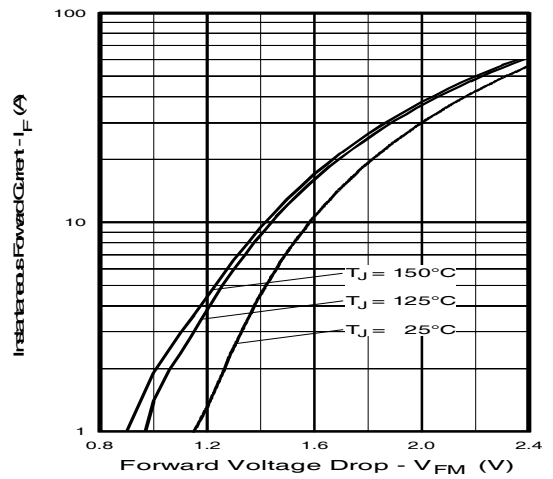
**Fig. 7 - Typ. Transfer Characteristics**  
 $V_{CE} = 50V$ ;  $t_p = 10\mu s$



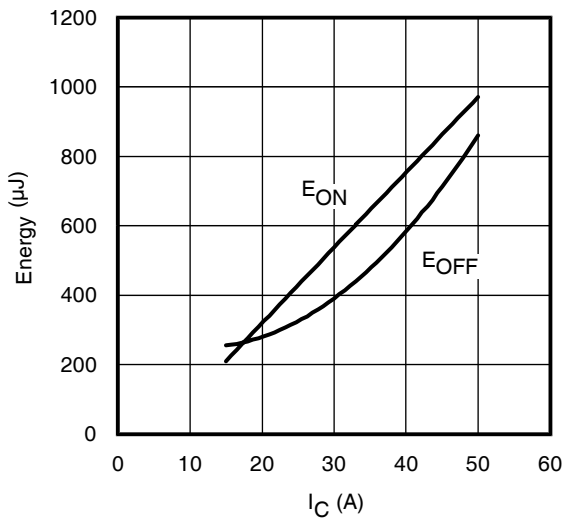
**Fig. 8 - Typical  $V_{CE}$  vs.  $V_{GE}$**   
 $T_J = 25^\circ C$



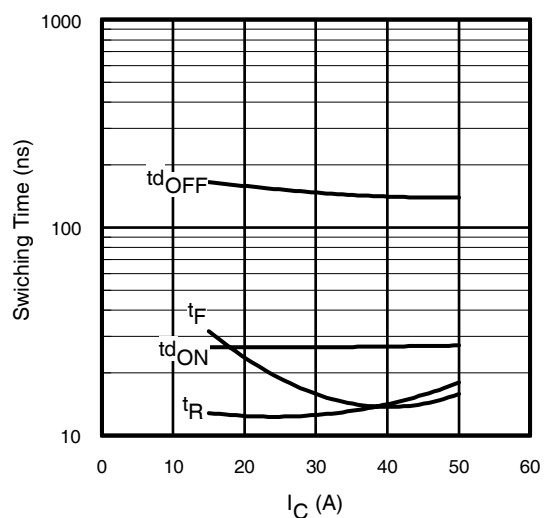
**Fig. 9 - Typical  $V_{CE}$  vs.  $V_{GE}$**   
 $T_J = 125^\circ C$



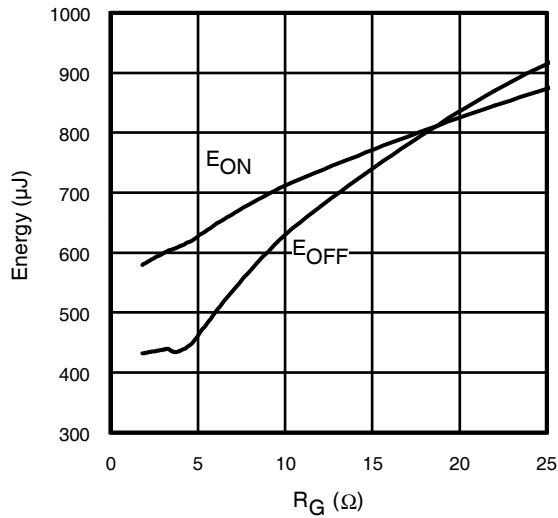
**Fig. 10 - Typ. Diode Forward Characteristics**  
 $t_p = 80\mu s$



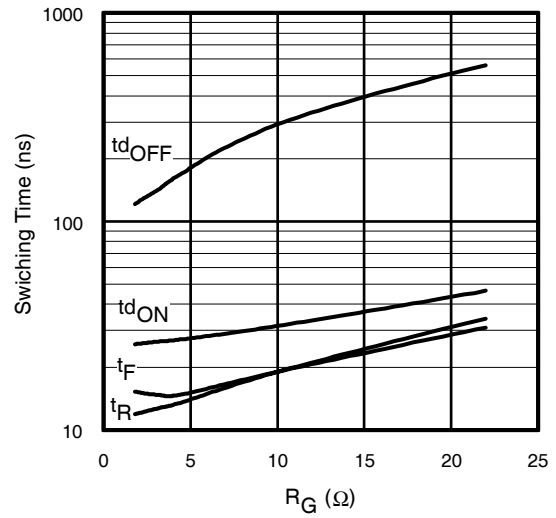
**Fig. 11 - Typ. Energy Loss vs.  $I_C$**   
 $T_J = 125^\circ C$ ;  $L = 200\mu H$ ;  $V_{CE} = 390V$ ,  $R_G = 3.3\Omega$ ;  $V_{GE} = 15V$ .  
Diode clamp used: 30ETH06 (See C.T.3)



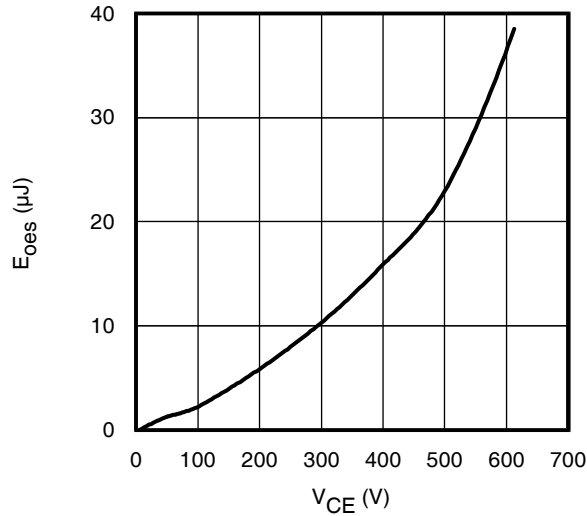
**Fig. 12 - Typ. Switching Time vs.  $I_C$**   
 $T_J = 125^\circ C$ ;  $L = 200\mu H$ ;  $V_{CE} = 390V$ ,  $R_G = 3.3\Omega$ ;  $V_{GE} = 15V$ .  
Diode clamp used: 30ETH06 (See C.T.3)



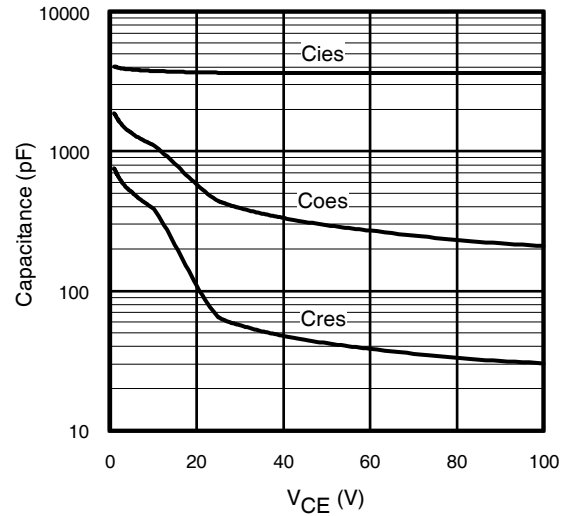
**Fig. 13 - Typ. Energy Loss vs.  $R_G$**   
 $T_J = 125^\circ\text{C}$ ;  $L = 200\mu\text{H}$ ;  $V_{CE} = 390\text{V}$ ;  $I_{CE} = 33\text{A}$ ;  $V_{GE} = 15\text{V}$   
 Diode clamp used: 30ETH06 (See C.T.3)



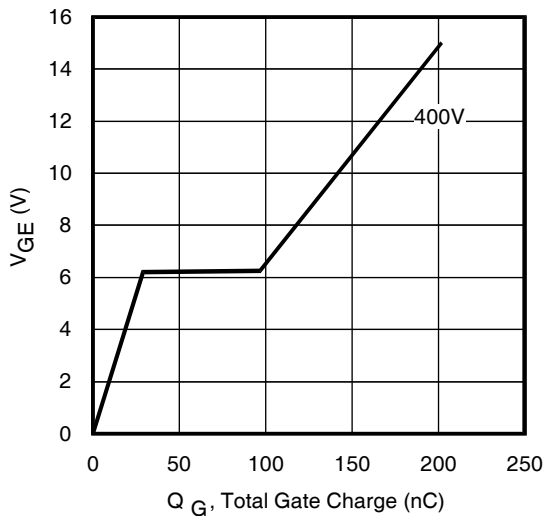
**Fig. 14 - Typ. Switching Time vs.  $R_G$**   
 $T_J = 125^\circ\text{C}$ ;  $L = 200\mu\text{H}$ ;  $V_{CE} = 390\text{V}$ ;  $I_{CE} = 33\text{A}$ ;  $V_{GE} = 15\text{V}$   
 Diode clamp used: 30ETH06 (See C.T.3)



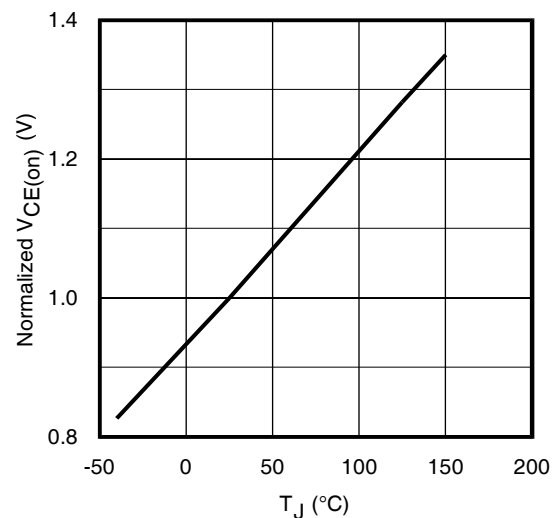
**Fig. 15- Typ. Output Capacitance  
 Stored Energy vs.  $V_{CE}$**



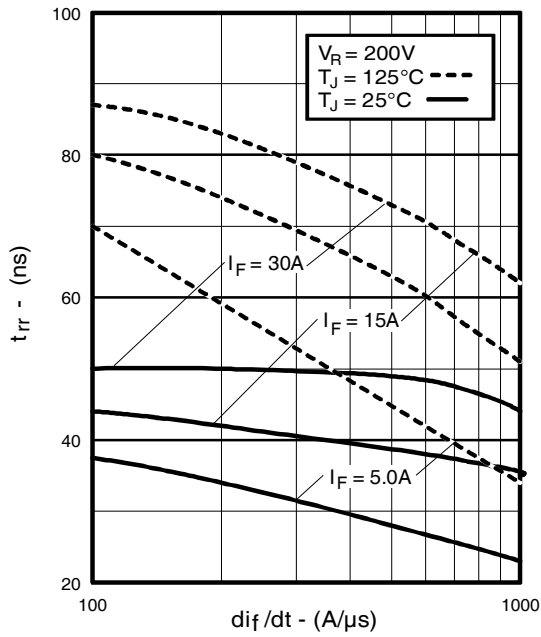
**Fig. 16- Typ. Capacitance vs.  $V_{CE}$**   
 $V_{GE} = 0\text{V}$ ;  $f = 1\text{MHz}$



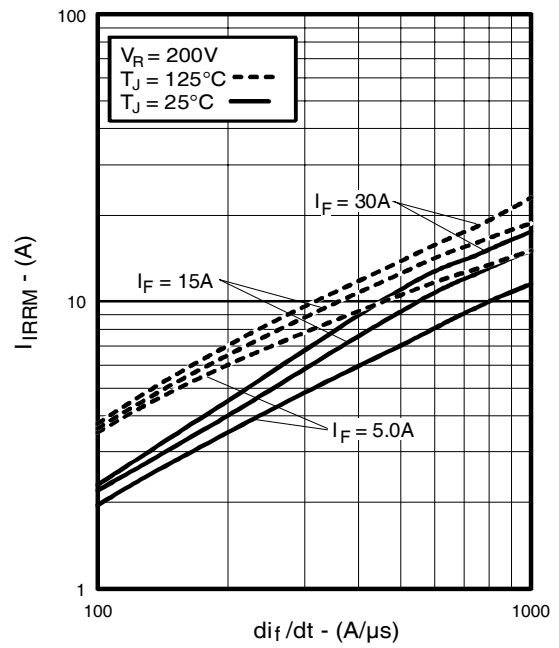
**Fig. 17 - Typical Gate Charge vs.  $V_{GE}$**   
 $I_{CE} = 33\text{A}$



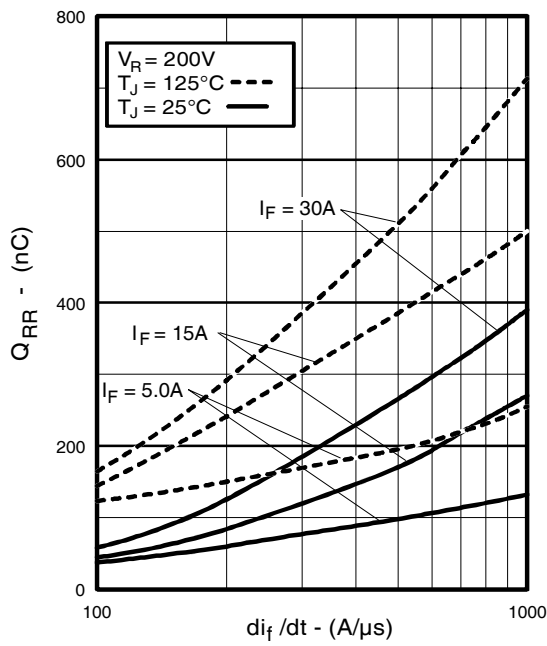
**Fig. 18 - Normalized Typ.  $V_{CE(on)}$   
 vs. Junction Temperature**  
 $I_C = 33\text{A}$ ,  $V_{GE} = 15\text{V}$



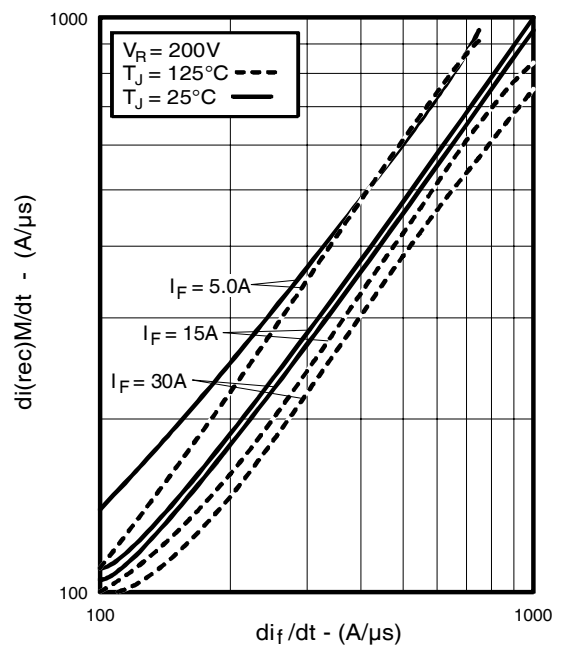
**Fig. 19** - Typical Reverse Recovery vs.  $di_f/dt$



**Fig. 20** - Typical Recovery Current vs.  $di_f/dt$



**Fig. 21** - Typical Stored Charge vs.  $di_f/dt$



**Fig. 22** - Typical  $di_{(rec)M}/dt$  vs.  $di_f/dt$

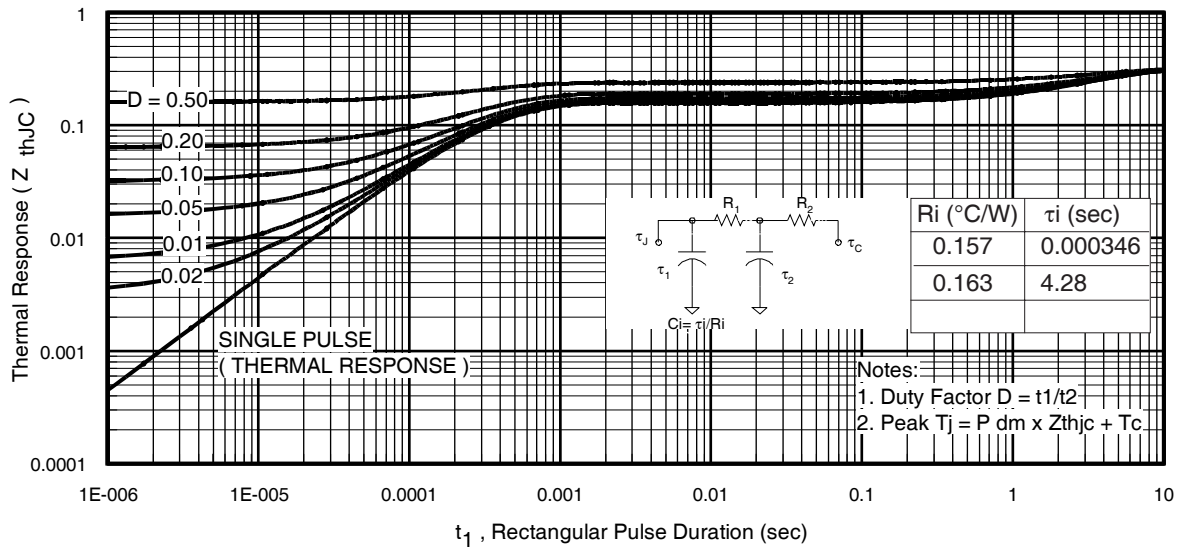


Fig 23. Maximum Transient Thermal Impedance, Junction-to-Case (IGBT)

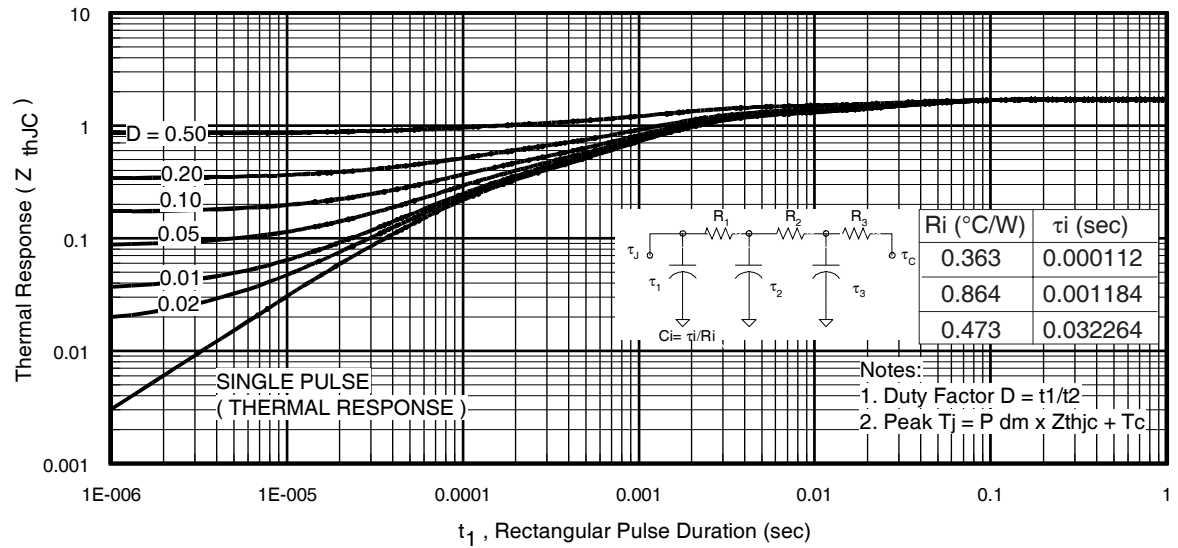
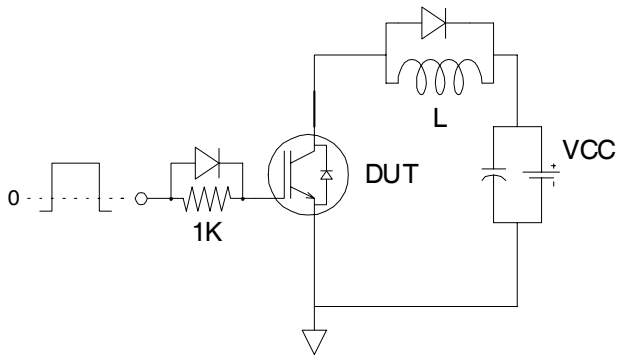
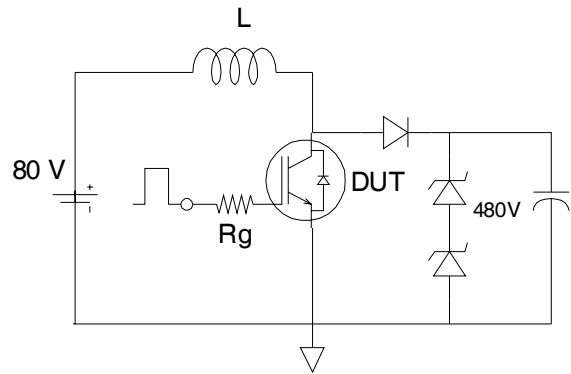


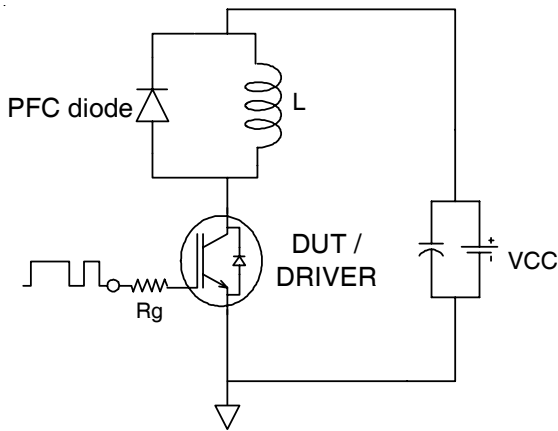
Fig. 24. Maximum Transient Thermal Impedance, Junction-to-Case (DIODE)



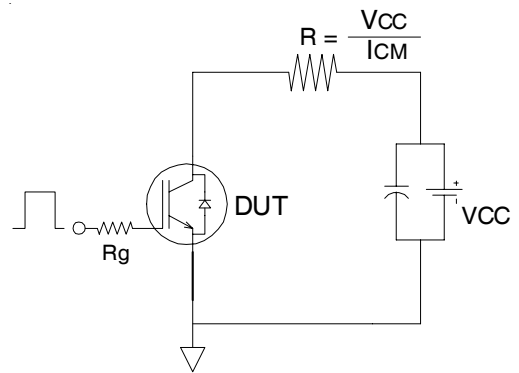
**Fig.C.T.1** - Gate Charge Circuit (turn-off)



**Fig.C.T.2** - RBSOA Circuit

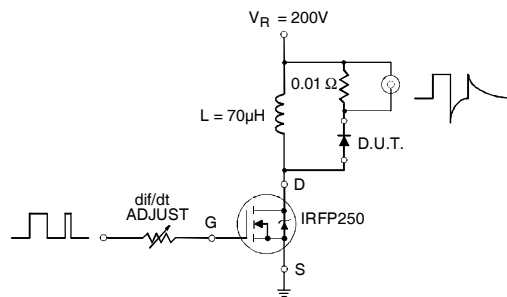


**Fig.C.T.3** - Switching Loss Circuit



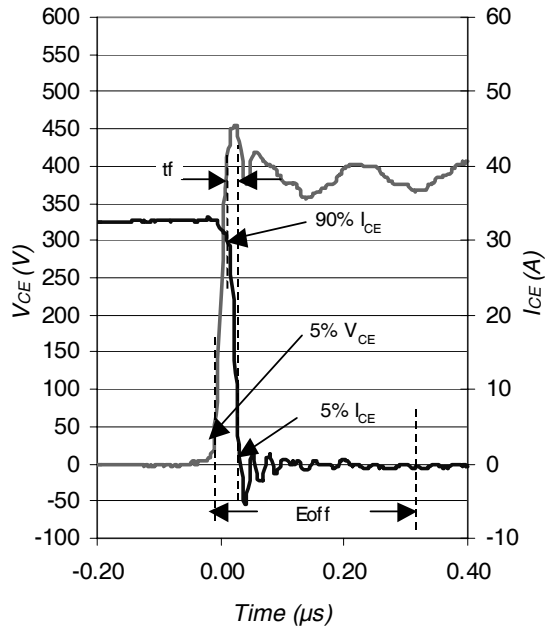
**Fig.C.T.4** - Resistive Load Circuit

### REVERSE RECOVERY CIRCUIT

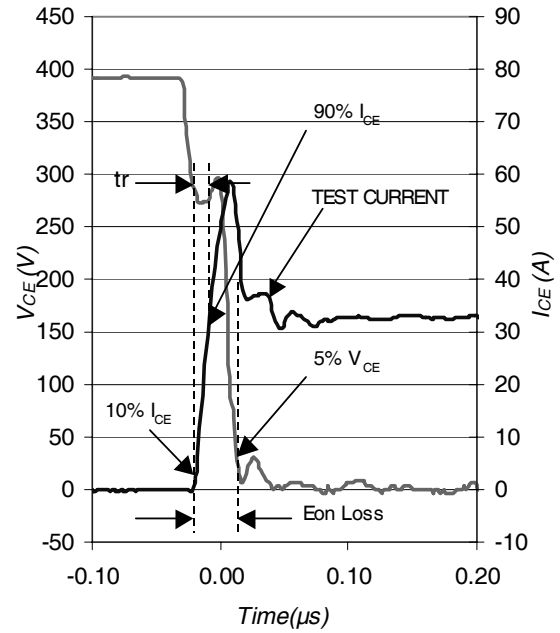


**Fig. C.T.5** - Reverse Recovery Parameter Test Circuit

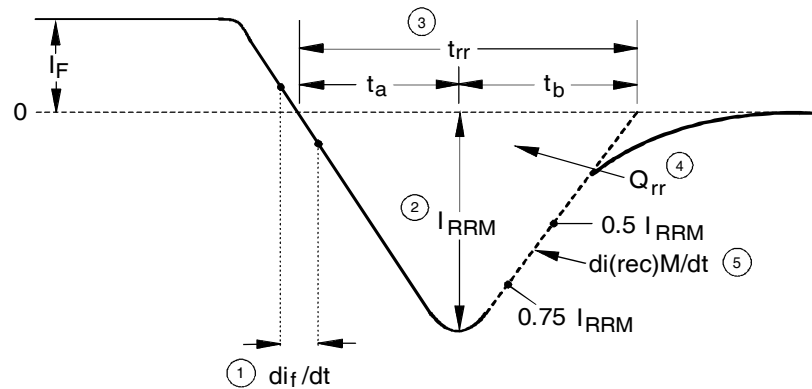




**Fig. WF1** - Typ. Turn-off Loss Waveform  
@  $T_J = 25^\circ\text{C}$  using Fig. CT.3



**Fig. WF2** - Typ. Turn-on Loss Waveform  
@  $T_J = 25^\circ\text{C}$  using Fig. CT.3



1.  $di_f/dt$  - Rate of change of current through zero crossing
2.  $I_{RRM}$  - Peak reverse recovery current
3.  $t_{rr}$  - Reverse recovery time measured from zero crossing point of negative going  $I_F$  to point where a line passing through  $0.75 I_{RRM}$  and  $0.50 I_{RRM}$  extrapolated to zero current
4.  $Q_{rr}$  - Area under curve defined by  $t_{rr}$  and  $I_{RRM}$   

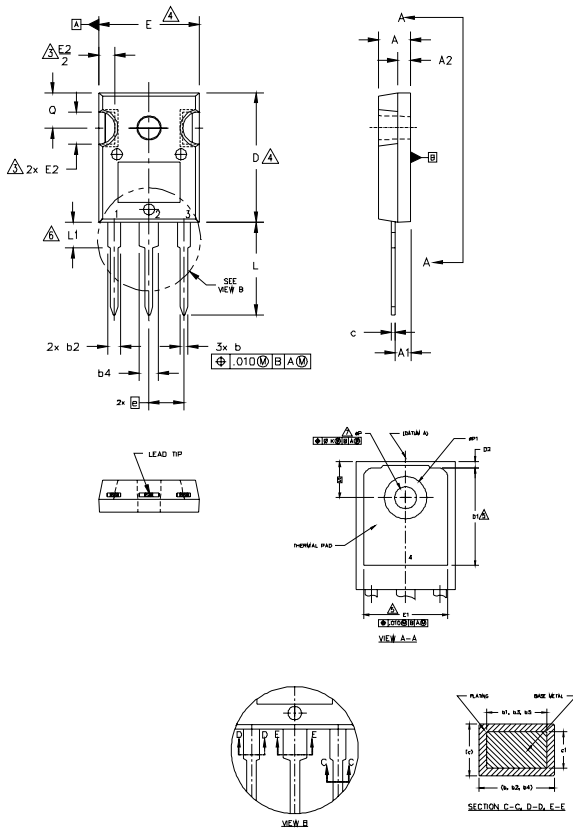
$$Q_{rr} = \frac{t_{rr} \times I_{RRM}}{2}$$
5.  $di_{(rec)M}/dt$  - Peak rate of change of current during  $t_b$  portion of  $t_{rr}$

**Fig. WF3** - Reverse Recovery Waveform and Definitions

# IRGP50B60PD1PbF

## TO-247AC Package Outline

Dimensions are shown in millimeters (inches)



NOTES:

1. DIMENSIONING AND TOLERANCING AS PER ASME Y14.5M 1994.
2. DIMENSIONS ARE SHOWN IN INCHES.
3. CONTOUR OF SLOT OPTIONAL.
4. DIMENSION D & E DO NOT INCLUDE MOLD FLASH. MOLD FLASH SHALL NOT EXCEED .005" (0.127) PER SIDE. THESE DIMENSIONS ARE MEASURED AT THE OUTERMOST EXTREMES OF THE PLASTIC BODY.
5. THERMAL PAD CONTOUR OPTIONAL WITHIN DIMENSIONS D1 & E1.
6. LEAD FINISH UNCONTROLLED IN L1.
7.  $\phi P$  TO HAVE A MAXIMUM DRAFT ANGLE OF 1.5 ° TO THE TOP OF THE PART WITH A MAXIMUM HOLE DIAMETER OF .154 INCH.
8. OUTLINE CONFORMS TO JEDEC OUTLINE TO-247AC .

SYMBOL	DIMENSIONS				NOTES
	INCHES		MILLIMETERS		
	MIN.	MAX.	MIN.	MAX.	
A	.183	.209	4.65	5.31	
A1	.087	.102	2.21	2.59	
A2	.059	.098	1.50	2.49	
b	.039	.055	0.99	1.40	
b1	.039	.053	0.99	1.35	
b2	.065	.094	1.65	2.39	
b3	.065	.092	1.65	2.34	
b4	.102	.135	2.59	3.43	
b5	.102	.133	2.59	3.38	
c	.015	.035	0.38	0.89	
c1	.015	.033	0.38	0.84	
D	.776	.815	19.71	20.70	4
D1	.515	-	13.08	-	5
D2	.020	.053	0.51	1.35	
E	.602	.625	15.29	15.87	4
E1	.530	-	13.46	-	
E2	.178	.216	4.52	5.49	
e	.215 BSC		5.46 BSC		
ek	.010		0.25		
L	.559	.634	14.20	16.10	
L1	.146	.169	3.71	4.29	
$\phi P$	.140	.144	3.56	3.66	
$\phi P1$	-	.291	-	7.39	
Q	.209	.224	5.31	5.69	
S	.217 BSC		5.51 BSC		

LEAD ASSIGNMENTS

HEXFET

- 1.- GATE
- 2.- DRAIN
- 3.- SOURCE
- 4.- DRAIN

IGBTs, CoPACK

- 1.- GATE
- 2.- COLLECTOR
- 3.- EMITTER
- 4.- COLLECTOR

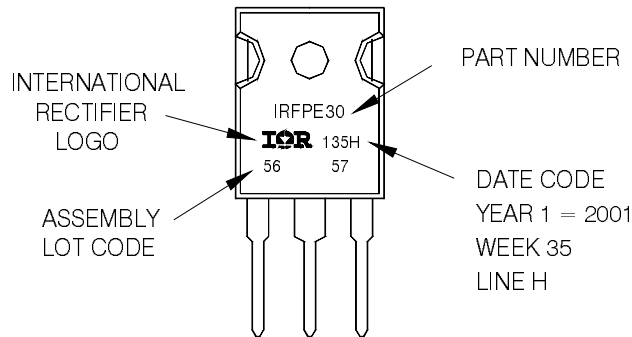
DIODES

- 1.- ANODE/OPEN
- 2.- CATHODE
- 3.- ANODE

## TO-247AC Part Marking Information

EXAMPLE: THIS IS AN IRFPE30  
WITH ASSEMBLY  
LOT CODE 5657  
ASSEMBLED ON WW 35, 2001  
IN THE ASSEMBLY LINE "H"

Note: "P" in assembly line position  
indicates "Lead-Free"



TO-247AC package is not recommended for Surface Mount Application.

Note: For the most current drawing please refer to IR website at <http://www.irf.com/package/>

Data and specifications subject to change without notice.  
This product has been designed and qualified for Industrial market.  
Qualification Standards can be found on IR's Web site.