



Product Specification

Issued Date: 4th December, 2013

Part Description: Pyroelectric infrared sensor

MURATA Part No.: IRA-S410ST01

The product specification in this sheet is for reference only.
The contents of this specification is subject to change.

You are requested to receive the latest specification and to return one copy of the specification to us with your receipt signature before going into mass production.

Product Promotion section 2
Sensor Products Department 1
Sensor Products Division
Device Unit
Murata MFG. Co.,Ltd.

MURATA MANUFACTURING CO., LTD.

1. Scope

This product specification is applied to dual element type pyroelectric infrared sensor IRA-S410ST01 used to detect infrared rays.

Please contact us when using this products for any other applications than described in the above.

2. Murata Part Number

IRA-S410ST01

3. Outline Drawing and Dimensions

3-1 Outline Dimensions

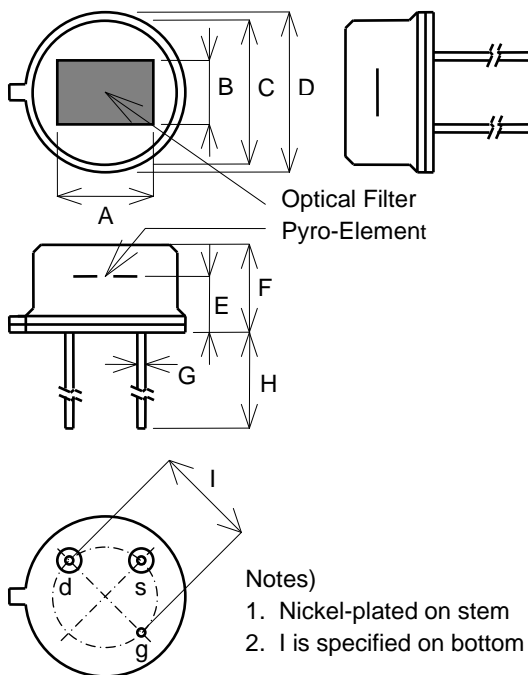

Symbol	Dimension
A	4.7±0.1mm
B	3.7±0.1mm
C	8.1±0.2mm
D	9.2±0.2mm
E	3.5±0.2mm
F	4.7±0.2mm
G	0.45±0.05mm
H	13.5±2mm
I	5.08±0.05mm

Symbol	Description
d (Drain)	Supply voltage
s (Source)	Output
g (Ground)	Ground

- Notes)
1. Nickel-plated on stem
 2. I is specified on bottom of stem

3-2 Pyroelectric Element

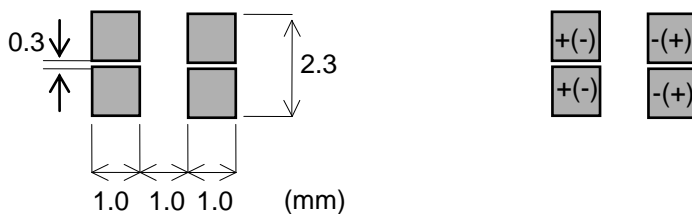

3-3 Equivalent Circuit

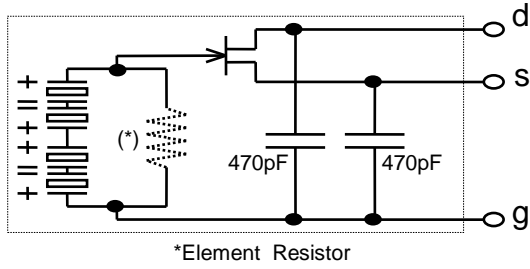

4. Marking

It has a marking on a side of the sensor.

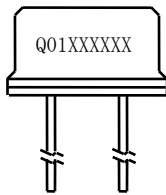

Q01 : Model code
 XXXXXX : Internal control number

5. Ratings and Characteristics (25°C, 50%RH)

5-1 Responsivity (Rv)

	Min.	(Typ.)
Responsivity (Rv)	5.2mVpp	7.0mVpp

Responsivity is measured with following system.

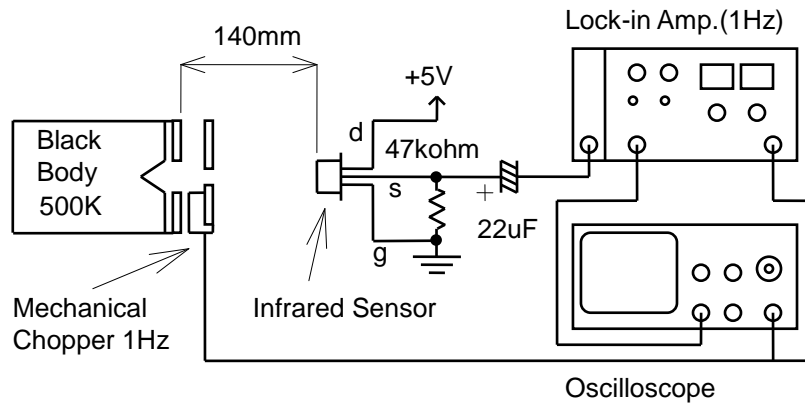

Figure 1. Test system of responsivity

5-2 Balance of Responsivity

Balance	10% Max.
---------	----------

$$\text{Balance(\%)} = |(R_r - R_l) / (R_r + R_l)| \times 100$$

R_r : Response from right element

R_l : Response from left element

5-3 White Noise Level

White Noise	200mVpp Max.
-------------	--------------

Conditions for measurement

- Test circuit : With the circuit shown in figure2.
- Measure Point : Across OUT and GND.
- Environment : In the electrically and optically shielded box kept at 25°C.

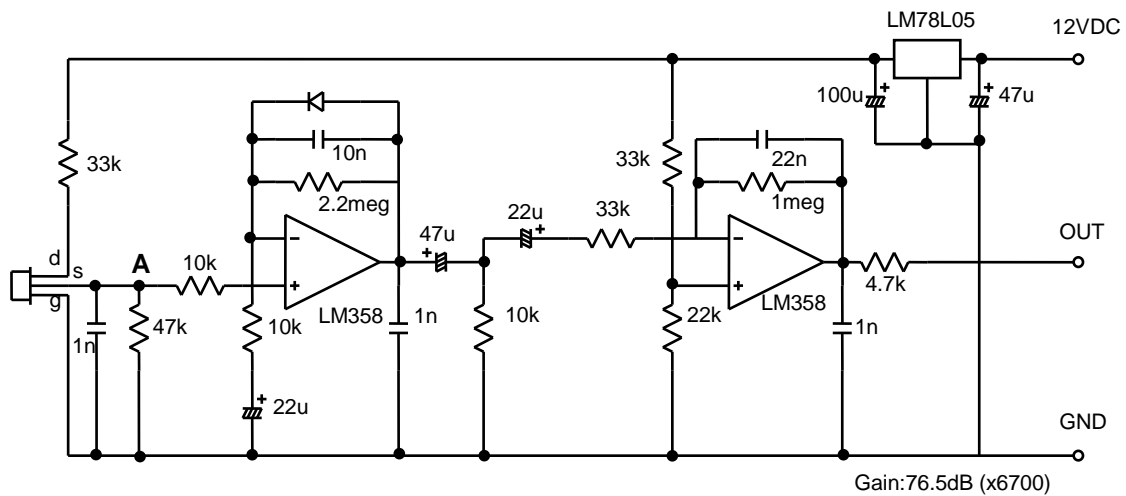

Figure 2. Test circuit

5-4 Source Voltage

Source voltage(Vs)	0.2 to 2.5 V
--------------------	--------------

Conditions for measurement

- Test circuit : With the circuit shown in figure2.
- Measure Point : Across A and GND.
- Environment : In the electrically and optically shielded and temperature controlled box.

5-5 Warm-up Time

Warm-up time	30sec. Max.
--------------	-------------

Conditions for measurement

- Test circuit : With the circuit shown in figure2.
 - Environment : In the electrically and optically shielded box kept at 25°C.
- Warm-up time is defined as time for Source Voltage to reach to specified value from turning on.

5-6 Supply Voltage Range
2.0 to 15.0 VDC

5-7 Recommendable Rs Value
47k ohm \leq Rs \leq 200k ohm
Resistance Rs is inserted across terminal-S and GND.

5-8 Field of View

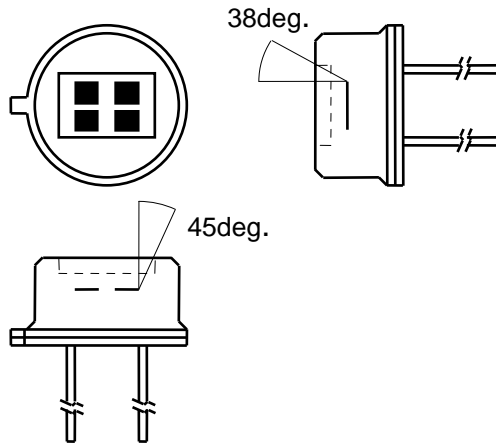

Figure3. Field of View

5-9 Optical Filter

Transmittance : See the graph shown in figure4.
Material : Single crystal silicon
Thickness : 0.50 ± 0.05mm

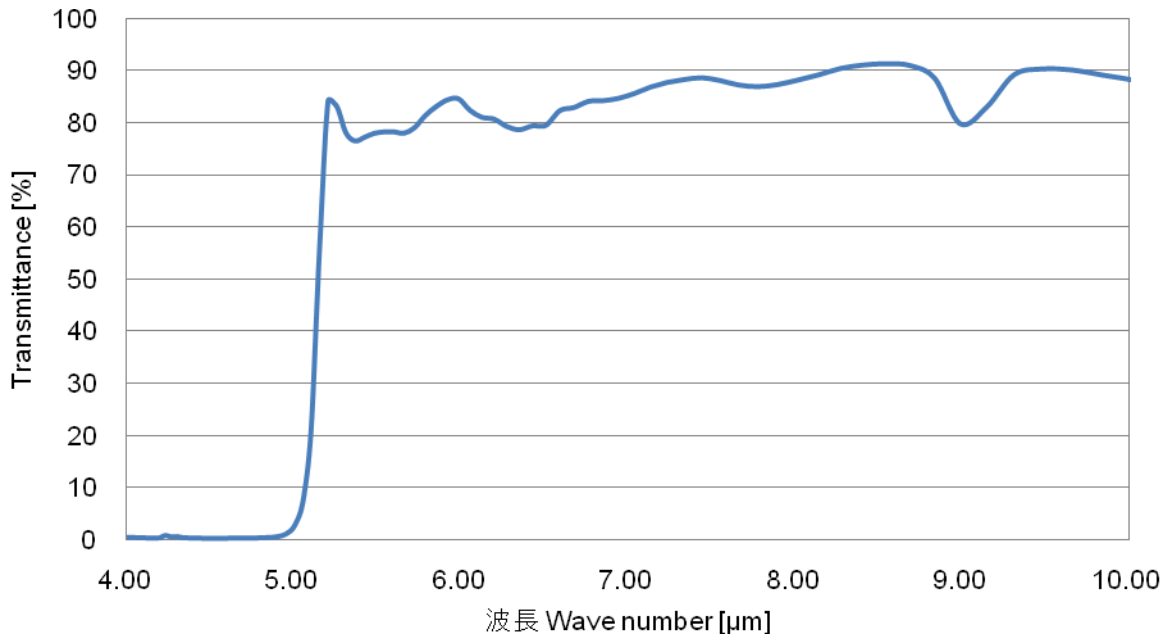

Figure4. Transmittance of optical filter (example)

6. Operating Temperature

-40 to 70 °C

7. Storage Temperature

-40 to 85 °C

8. Package and Marking

100 pieces sensors are packed in a unit box as shown in (A).
Marking is on the box as per (B).

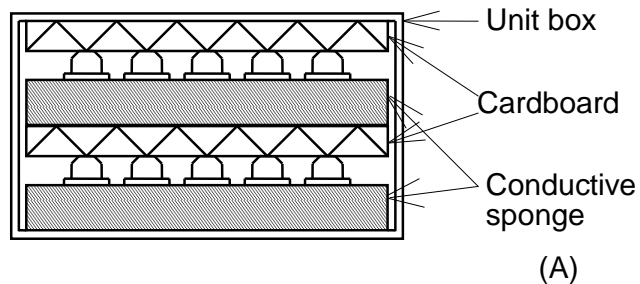

IRA-S410ST01	
Inspection lot No.	100pcs

(B)

9. Reliability

Judgment criteria for 9-1 to 9-7.

After each one of the test, the sensor is kept for three hours at room temperature, then it is evaluated with the following criteria.

Items	Judgment criteria
External appearance	No significant damage
Responsivity	Within $\pm 20\%$ shift from initial value
White noise	within initial value +100mV
Source voltage	within rated value

9-1 High temperature

100°C for 500hours

9-2 Low temperature

-40°C for 500hours

9-3 Humidity

60°C, 95%RH for 500hours

9-4 Heat cycle

20 times of the following cycle

-25°C, 30min.⇒ Room temp. 30min.⇒ 55°C, 30min.⇒ Room temp.

9-5 Vibration

Apply vibration of amplitude of 1.5mm with 10 to 55Hz bands to each of 3 perpendicular directions (x, y, z) for an hour.

9-6 Shock

Apply shock of 100G sinewave by standard shock tester to each 3 perpendicular directions (x, y, z). (1G=9.8m/s²)

9-7 Soldering heat

Immerse up to 3mm from the bottom of stem in solder bath of 260±5°C for 10±1sec..

9-8 Hermetic sealing

Conform to MIL-STD-202F chapter 112D, condition D.

Immerse in fluorocarbon bath (FC-40) of 125±5°C for 20sec..

There should be no generation of bubbles.

9-9 Solderability

Conform to MIL-STD-202F chapter 208B.

Terminal immerse the Rosin flux after immerse in fluorocarbon bath of 230±5°C for 5sec ±0.5sec when a solder attaches to a terminal more than **75%**.

10. ⚠ Caution**10-1 Limitation of Applications**

Please avoid using this product for the applications listed below which require especially high reliability for the prevention of defects that might directly cause damage to the third party's life, body or property.

When this product is used for the applications listed below, we shall not be liable for any claims on the product.

1. Aircraft equipment
2. Aerospace equipment
3. Undersea equipment
4. Power plant control equipment
5. Medical equipment
6. Transportation equipment (vehicles, trains, ships, etc.)
7. Traffic signal equipment
8. Data-processing equipment
9. Application of similar complexity and/or reliability requirement to the applications listed in the above

10-2 Fail-safe

Be sure to provide an appropriate fail-safe function on your product to prevent a second damage that may be caused by the abnormal function or the failure of our product.

11. Caution in use**11-1 Notice in design**

- 1) In the case of outdoor use, suitable optical filter and water and humidity proof structure should be applied.
- 2) To prevent failure or malfunction, Please use a stabilized power supply.
- 3) Please avoid using the sensor in the following conditions because it may cause failure or malfunction ;
 - a) In such a fluid as water, alcohol etc. corrosive gas (SO₂, Cl₂, NO_x etc.) or sea breeze.
 - b) In high humidity.
 - c) In a place exposed directly to sunlight or headlight of automobile.
 - d) In a place exposed to rapid ambient temperature change.
 - e) In a place exposed directly to blow from air-conditioner or heater.
 - f) In a place exposed to strong vibration.
 - g) In a place exposed to strong electromagnetic field.
 - h) In such a place where infrared ray is shaded.
 - i) In any other place similar to the above (a) through (h).

11-2 Notice in handling and storage

- 1) Optical filter of sensor should not be scratched or soiled.
- 2) Strong shock should be avoided.
- 3) Electrostatics and strong electromagnetic field should be avoided.
- 4) Sensor should be kept on conductive sponge.
- 5) High temperature, high humidity, fluid as water or alcohol etc., corrosive gas (SO₂, Cl₂, NO_x etc.) and sea breeze should be avoided.
- 6) Use the products within 6 months after receiving.

11-3 Notice in mounting

1) Soldering

- i) Hand soldering should be applied.
- ii) Soldering should be done quickly as following.

Temperature of soldering iron : under 350°C	
Distance from can case	Period of time
1 to 3mm	Within 3sec. per point
Over 3mm	Within 10sec. per point

- iii) Soldering flux should be rosin flux and not contain more than 0.2wt % chlorine.

2) Cleaning

Soldering flux should be removed after soldering.
Soldering flux may cause malfunction or degradation of character unless sufficiently cleaned.

12  Note

- 1) Please make sure that your product has been evaluated in view of your specifications with our product being mounted to your product.
- 2) You are requested not to use our product deviating from the agreed specifications.
- 3) We consider it not to appropriate to include any terms and conditions with regard to the business transaction in the product specifications, drawings or other technical documents. Therefore, if your technical documents as above include such terms and conditions such as warranty clause, product liability clause, or intellectual property infringement liability clause, they will be deemed to be invalid.