

RH850 Evaluation Platform

# RH850/P1L-C 100-pin PiggyBack board V1

## Y-RH850-P1XC-100PIN-PB-T1-V1

All information contained in these materials, including products and product specifications, represents information on the product at the time of publication and is subject to change by Renesas Electronics Corp. without notice. Please review the latest information published by Renesas Electronics Corp. through various means, including the Renesas Technology Corp. website (<http://www.renesas.com>).

The newest version of this document can be obtained from the following web location  
<http://www.renesas.eu/updates?oc=Y-RH850-P1XC-100PIN-PB-T1-V1>.

---

## Table of Contents

<b>Chapter 1</b>	<b>Introduction .....</b>	<b>3</b>
<b>Chapter 2</b>	<b>Overview .....</b>	<b>4</b>
2.1	Overview .....	4
2.2	Mounting of the device .....	5
<b>Chapter 3</b>	<b>Power supply .....</b>	<b>6</b>
3.1	Board power connection .....	6
3.2	Voltage distribution.....	7
<b>Chapter 4</b>	<b>Clock sources.....</b>	<b>8</b>
4.1.1	MainOsc.....	8
4.1.2	Programmable Oscillator .....	8
<b>Chapter 5</b>	<b>Debug and Programming interface .....</b>	<b>9</b>
<b>Chapter 6</b>	<b>Connectors for ports of device.....</b>	<b>10</b>
6.1	Connectors for ADC voltage supply .....	10
6.2	Push button for RESET .....	10
6.3	Mode Selection .....	10
6.4	Connectors to MainBoard.....	11
6.4.1	Connector CN1 .....	11
6.4.2	Connector CN2.....	12
6.4.3	Connector CN3.....	12
<b>Chapter 7</b>	<b>Other circuitry.....</b>	<b>15</b>
7.1	Signalling for CVMOUTZ and ERROROUTZ.....	15
7.2	Pin Headers for Pull-Down and Pull-Up.....	15
7.3	Signalling LEDs .....	15
<b>Chapter 8</b>	<b>Precautions.....</b>	<b>16</b>
<b>Chapter 9</b>	<b>Mechanical dimensions .....</b>	<b>17</b>
<b>Chapter 10</b>	<b>Schematic .....</b>	<b>18</b>
<b>Chapter 11</b>	<b>Revision History .....</b>	<b>22</b>

---

## Chapter 1 Introduction

The RH850/P1L-C Application Board is part of the RH850 Evaluation Platform and serves as a simple and easy to use platform for evaluating the features and performance of Renesas Electronics 32-bit RH850/P1L-C microcontrollers in a QFP100 package. The PiggyBack board (Y-RH850-P1XC-100PIN-PB-T1-V1) can be used as a standalone board, or can be mated with a mainboard (Y-RH850-X1X-MB-Tx-Vx) for extended functionality.

Main features:

- Socket for mounting of device
- Standalone operation of the board
- Direct supply of device voltage (typ. 3.3V and 5V)
- Device programming capability
- Device debugging capability
- Pin headers for direct access to each functional device pin
- Reset switch
- MainOSC circuitry
- Connectors to MainBoard
- Operating temperature from 0°C to +40°C

This document describes the functionality provided by the PiggyBack board and guides the user through its operation.

For details regarding the operation of the microcontroller, refer to the corresponding User's Manual.

# Chapter 2 Overview

## 2.1 Overview

Figures 1 and 2 provide a schematic view of the PiggyBack board.

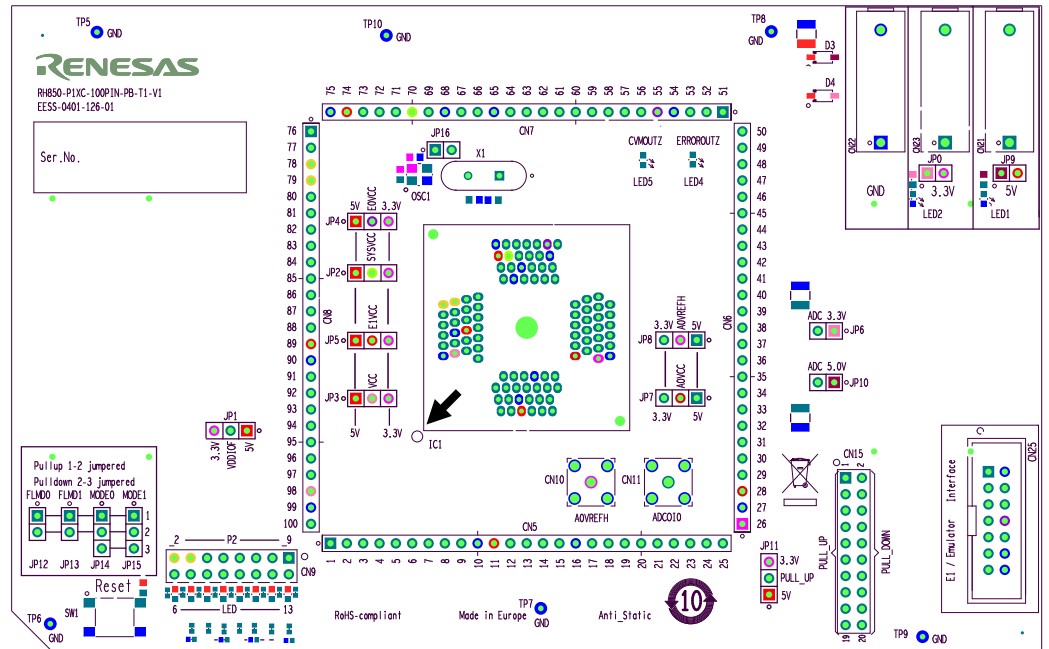

Figure 1 PiggyBack Board Schematic Top View

The black arrow denotes the position of socket pin #1.

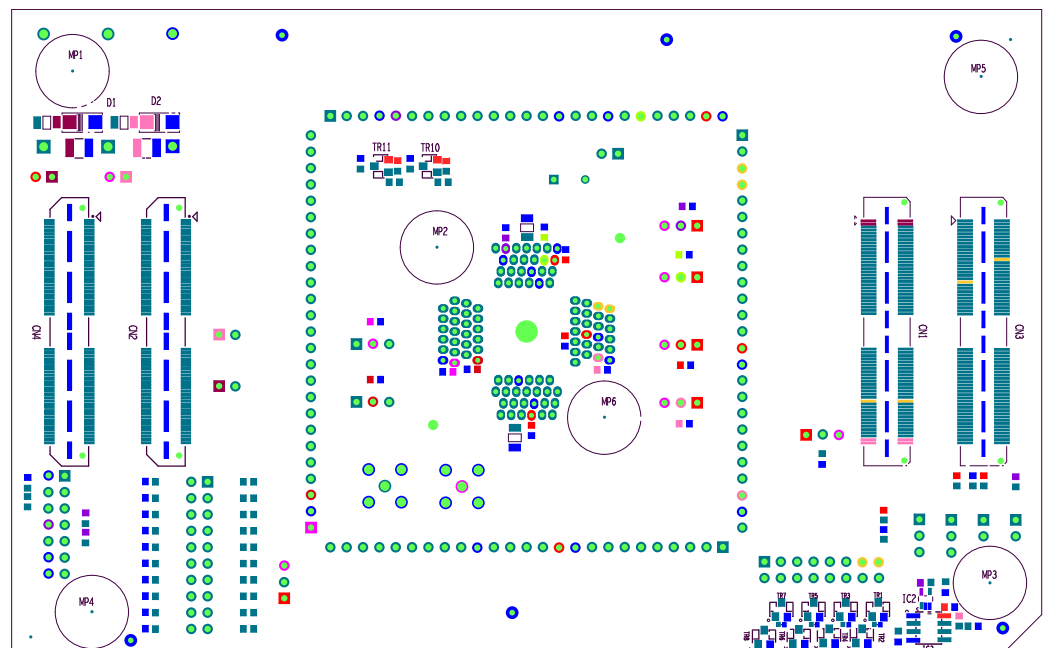

Figure 2 PiggyBack Board Schematic Bottom View

---

## 2.2

### Mounting of the device

The board is designed for use with the following device:

RH850/P1L-C in 100pin QFP with 0.4mm pin pitch

The device must be placed inside the socket IC1. To insert the device, press down the lid of the socket, align the #1 pin of the device to the #1 pin of the socket, insert the device into the socket and release the lid.

---

## Chapter 3 Power supply

### 3.1 Board power connection

For operation of the device, a supply voltage must be connected to the board. There are several possibilities to power the device.

Within this document the following voltages are considered as 'typical' connections:

Voltage1 = 5V

Voltage2 = 3.3V

#### Direct voltage supply

Two different voltages can be supplied to the board.

The following connectors are available to supply those voltages directly:

- Three 4mm 'banana-type' connectors:
  - Two red connectors for voltages Voltage1 (CN21) and Voltage2 (CN23).
  - A black connector for ground (GND) connection (CN22).

**Note:** The three connectors are supplied with the board but not assembled.

For details about voltage distribution, refer to **Chapter 3.2 'Voltage distribution'**.

#### Supply by E1 emulator

The E1 emulator that is used for debug purposes and flash programming can also supply a single operating voltage ('Dbg\_Voltage'). This voltage is connected via E0VCC to the board.

See the documentation of the E1 and **Chapter 5 'Debug and Programming interface'** for details.

#### Supply by MainBoard

In case the PiggyBack board is mounted on a MainBoard, the voltage Voltage1 and Voltage2 is supplied by the on-board regulator of the MainBoard.

**CAUTION:** Do not supply Voltage1 or Voltage2 directly to the PiggyBack board in case it is mounted on the MainBoard.

For each of the voltages, Voltage1 and Voltage2 a green LED (LED1 and LED2, respectively) is available to signal that the related voltage is available on the PiggyBack board. The corresponding LEDs are placed directly beneath the connectors of the related voltage.

## 3.2 Voltage distribution

The table shows the required device power supply pins and their function. For detailed explanation of their function, please refer to the user documentation of the corresponding device:

Device Supply Pin
SYSVCC
VCC
EnVCC (n = 0, 1)
AnVCC (n = 0, 1)
AnVREFH (n = 0, 1)

Additional one power supply for the MainBoard can be selected:

Supply voltage	Function
VDDIOF	IO supply voltage for components located on a connected mainboard.

The following figure shows the configurable voltage distribution on the PiggyBack board.

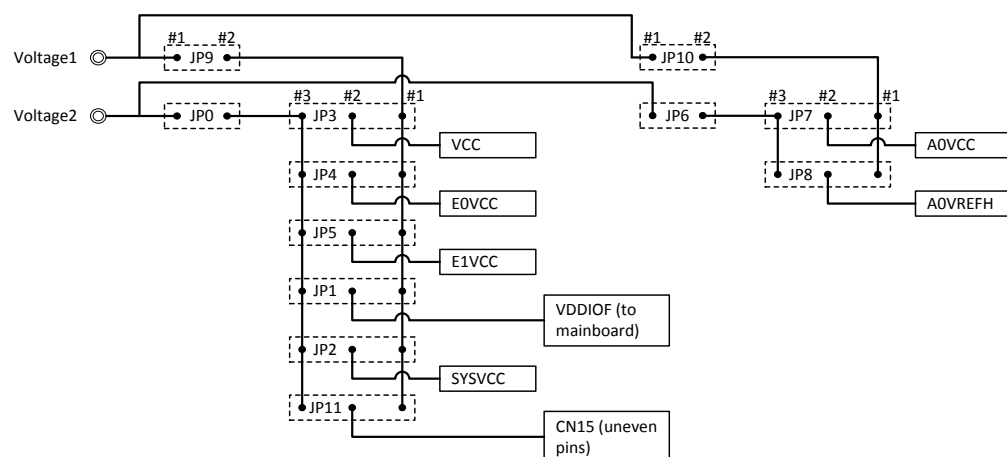

Figure 3 Voltage Distribution on the PiggyBack Board

- All power supply lines can be interrupted by jumpers. This provides the possibility to measure the current consumption of each individual power domain of the device.
- The IO supply voltage for the Mainboard (VDDIOF) can be connected via jumper JP1 to Voltage1 or Voltage2, if the PiggyBack board is mounted on a MainBoard.
- The voltage available at the uneven pins of CN15 is configurable via jumper JP11

---

## Chapter 4 Clock sources

One external crystal oscillator for the device clock supply is provided with the board.

### 4.1.1 MainOsc

A crystal or ceramic resonator can be mounted on socket X1.

A 16Mhz oscillator is supplied with the board.

### 4.1.2 Programmable Oscillator

It is possible to mount a programmable crystal oscillator on the PiggyBack board at OSC1. The available footprint and circuitry is designed for a SG-8002CE programmable crystal oscillator from Epson Toyocom. The output from this oscillator can be connected to port X1 via jumper JP16. The SG-8002CE is neither mounted nor provided with the board. For details about the available circuitry refer to **Chapter 10 'Schematic'**. A resonator mounted on socket X1 must not be used in parallel to another clock source.



---

## Chapter 5 Debug and Programming interface

For connection of the microcontroller debug and flash programming tools, the connector CN25 with fourteen pins is provided.

The signal connection of the connector CN25 is shown in the table below:

CN25 Pin	Device Port	Device Signal
1	JP0_2	TCK / LPDCLK / FLSCI3SCKI
2	GND	GND
3	JP0_4	TRSTZ
4	FLMD0	FLMD0
5	JP0_1	TDO / LPDO / FLSCI3TXD
6	-	-
7	JP0_0	TDI / LPDI / FLSCI3RXD / FLSCI3TXD
8	'Dbg_Voltage'	E0VCC
9	JP0_3	TMS
10	-	-
11	JP0_5	RDYZ / LPDCLKOUT
12	GND	-
13	RESET	RESETZ
14	GND	-

## Chapter 6 Connectors for ports of device

Connection to each functional pin of the devices is possible via the connectors CN5 to CN8.

**CAUTION:** The pin headers are directly connected to the pins of the device, therefore special care must be taken to avoid any electrostatic or other damage to the device.

### 6.1 Connectors for ADC voltage supply

It is possible to apply the ADC related reference, as well as one input voltage via SMA connectors (CN10 and CN11). These are directly connected (JP8 is bypassed) to the following pins of the device

Device Port
CN11 -> ADC0I0
CN10 -> A0VREFH

The SMA connectors are not mounted on nor provided with the boards. SMA connectors that fit to the following mounting holes available on the board can be mounted on the board

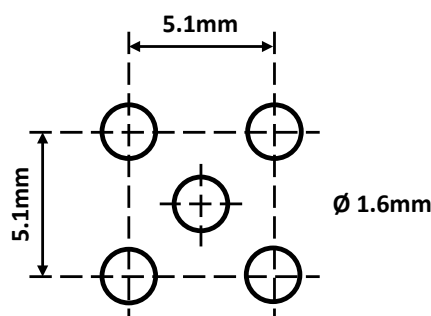

Figure 4 Mounting Holes for SMA Connectors

### 6.2 Push button for RESET

In order to issue a RESET to the device, the push-button SW1 is available.

### 6.3 Mode Selection

The PiggyBack Board gives the possibility to configure the following mode pins

- FLMD0 via jumper JP12
- FLMD1 via jumper JP13
- MODE0 via jumper JP14
- MODE1 via jumper JP15

To apply “High” or “Low” to the mode pins, the pins 1 and 2, or the pins 2 and 3 of the corresponding jumper must be shorted, respectively.

**Note:** Pin 1 of the jumpers is marked by a small circle.

**CAUTION:** Be careful in configuration of mode related pins, as wrong configuration can cause irregular behaviour of the devices. Be sure to check the corresponding User Manual, for details, which modes can be selected for the used device.

## 6.4 Connectors to MainBoard

Three connectors (CN1, CN2 and CN3) are available to connect the PiggyBack board to a MainBoard. Regarding the function on the MainBoard, please refer to the UM of any supported MainBoard (Y-RH850-X1X-MB-Tx-Vx).

Some functions might not be available for every device. Therefore, please refer to the corresponding User's Manual for available pins on the used device, and a detailed explanation of their function.

### 6.4.1 Connector CN1

Pin	Function on MainBoard	Device Port	Pin	Function on MainBoard	Device Port
1	Voltage1	-	2	Voltage1	-
3	Voltage1	-	4	Voltage1	-
5	RESET	RESETZ	6	NMI	P5_7
7	-	-	8	-	-
9	INT0	P4_7	10	INT1	P2_7
11	INT2	P5_13	12	INT3	P3_8
13	-	-	14	-	-
15	UART0TX	P5_8	16	UART1TX	P5_5
17	UART0RX	P5_9	18	UART1RX	P5_4
19	LIN0TX	P5_8	20	LIN1TX	P5_5
21	LIN0RX	P5_9	22	LIN1RX	P5_4
23	IIC0SDL	P2_0	24	-	-
25	IIC0SDA	P2_1	26	-	-
27	CAN0TX	P5_1	28	CAN1TX	P4_6
29	CAN0RX	P5_0	30	CAN1RX	P4_5
31	SENT0IN	P0_0	32	SENT1IN	P0_1
33	SENT0OUT	P2_4	34	SENT1OUT	P3_13
35	-	-	36	-	-
37	-	-	38	-	-
39	-	-	40	-	-
41	-	-	42	-	-
43	-	-	44	-	-
45	-	-	46	-	-
47	-	-	48	-	-
49	-	-	50	-	-
51	-	-	52	-	-
53	-	-	54	-	-
55	-	-	56	-	-
57	-	-	58	-	-
59	-	-	60	-	-
61	-	-	62	-	-
63	-	-	64	-	-
65	-	-	66	-	-

Pin	Function on MainBoard	Device Port	Pin	Function on MainBoard	Device Port
67	-	-	68	-	-
69	-	-	70	-	-
71	-	-	72	-	-
73	-	-	74	-	-
75	-	-	76	-	-
77	-	-	78	-	-
79	-	-	80	-	-
81	-	-	82	-	-
83	-	-	84	-	-
85	DIGIO_0	P5_6	86	DIGIO_1	P5_7
87	DIGIO_2	P5_10	88	DIGIO_3	P5_14
89	DIGIO_4	P5_15	90	DIGIO_5	P1_2
91	DIGIO_6	P2_0	92	DIGIO_7	P2_1
93	DIGIO_8	P2_2	94	DIGIO_9	P2_3
95	DIGIO_10	P2_4	96	DIGIO_11	P2_5
97	DIGIO_12	P2_6	98	DIGIO_13	P2_7
99	DIGIO_14	P2_8	100	DIGIO_15	P2_9
101	-	-	102	-	-
103	MUX0	P4_0	104	MUX1	P4_8
105	MUX2	P4_9	106	-	-
107	ADC0	ADC0I0	108	ADC1	ADC0I1
109	ADC2	ADC0I2	110	ADC3	ADC0I10
111	ADC4	ADC0I11	112	ADC5	ADC0I12
113	ADC6	ADC0I13	114	ADC7	ADC0I14
115	VDDIOF	-	116	VDDIOF	-
117	Voltage2	-	118	Voltage2	-
119	Voltage2	-	120	Voltage2	-

#### 6.4.2 Connector CN2

CN2 is mounted on the PiggyBack board to enable a stable mechanical connection to the currently available MainBoard (Y-RH850-X1X-MB-Tx-Vx). No function is assigned to CN2

#### 6.4.3 Connector CN3

Pin	Function on MainBoard	Device Port	Pin	Function on MainBoard	Device Port
1	-	-	2	-	-
3	-	-	4	-	-
5	-	-	6	-	-

Pin	Function on MainBoard	Device Port	Pin	Function on MainBoard	Device Port
7	-	-	8	-	-
9	-	-	10	CSIH1CSS0	P4_1
11	-	-	12	-	-
13	-	-	14	-	-
15	-	-	16	-	-
17	-	-	18	-	-
19	-	-	20	-	-
21	CSIH1CSS2	P3_12	22	CSIH1CSS7	P3_11
23	-	-	24	-	-
25	-	-	26	DIGIO	P2_2
27	-	-	28	CSIH1SO	P4_2
29	CSIH1SC	P4_3	30	CSIH1SI	P4_4
31	-	-	32	-	-
33	-	-	34	-	-
35	-	-	36	-	-
37	-	-	38	-	-
39	DIGIO	P2_3	40	-	-
41	-	-	42	-	-
43	-	-	44	-	-
45	-	-	46	-	-
47	-	-	48	-	-
49	-	-	50	-	-
51	-	-	52	-	-
53	-	-	54	-	-
55	-	-	56	-	-
57	-	-	58	-	-
59	-	-	60	-	-
61	-	-	62	-	-
63	-	-	64	-	-
65	-	-	66	-	-
67	-	-	68	-	-
69	-	-	70	-	-
71	-	-	72	-	-
73	-	-	74	-	-
75	-	-	76	-	-
77	-	-	78	-	-
79	-	-	80	-	-
81	-	-	82	-	-
83	-	-	84	-	-
85	-	-	86	-	-
87	-	-	88	-	-
89	-	-	90	-	-
91	-	-	92	-	-

---

Pin	Function on MainBoard	Device Port		Pin	Function on MainBoard	Device Port
93	-	-		94	-	-
95	-	-		96	-	-
97	-	-		98	-	-
99	-	-		100	-	-
101	-	-		102	-	-
103	-	-		104	-	-
105	-	-		106	-	-
107	-	-		108	-	-
109	-	-		110	-	-
111	-	-		112	-	-
113	-	-		114	-	-
115	-	-		116	-	-
117	-	-		118	-	-
119	-	-		120	-	-

---

## Chapter 7 Other circuitry

### 7.1 Signalling for CVMOUTZ and ERROROUTZ

Two red LEDs, LED5 and LED4 are available to indicate a “low” output signal from CVMOUTZ and ERROROUTZ, respectively.

### 7.2 Pin Headers for Pull-Down and Pull-Up

A connector CN15 is available to enable easy connection to Voltage1/Voltage2 (5V/3.3V) or GND via pull-up or pull-down resistances, respectively. The voltage supply to the uneven pins can be configured via JP11. See **3.2 'Voltage distribution'** for details.

Hereby uneven pins from 1 to 19 (in total ten) are configured as pull-up pin headers, while the even numbers from 2 to 20 (in total ten) can be used for pull-down.

By connecting device port pins from CN5 – 8 to CN9 it is therefore possible to pull a desired port pin to “Low” or “High”.

### 7.3 Signalling LEDs

Eight LEDs are provided to allow visual observation of the output state of device port pins. Device pins P2\_2 to P2\_9 are connected to the uneven pins 15 to 1 of the pin header CN9, while the LEDs 6 to 13 are connected to the even pins 16 to 2, respectively. Thus the LEDs can be either connected to the device port pins P2\_2 to P2\_9 via jumper or any device port pin can be connected directly to the even pin headers.

---

## Chapter 8 Precautions

No limitations are known at the release of this document.



# Chapter 9 Mechanical dimensions

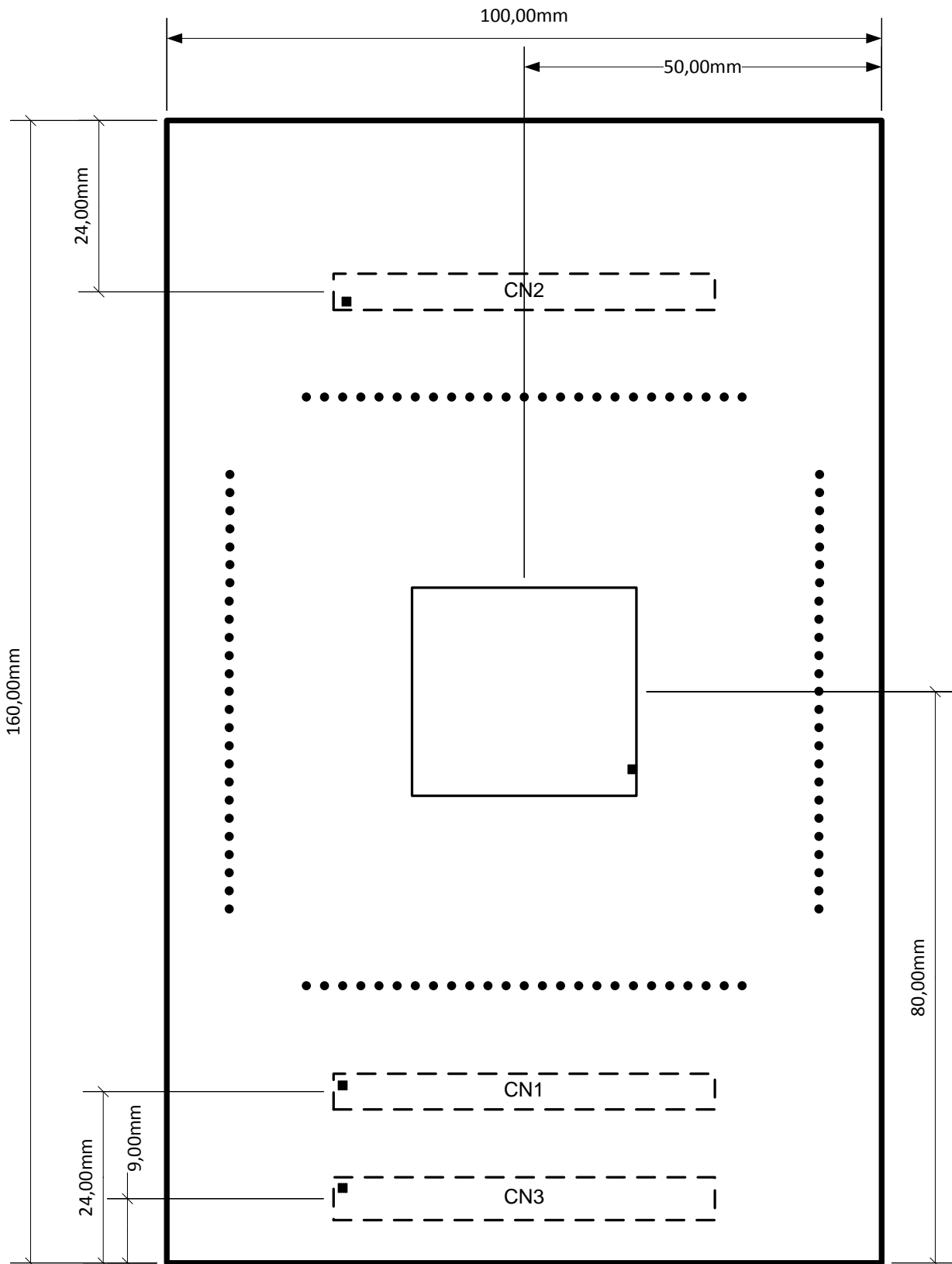

---

## Chapter 10 Schematic

**CAUTION:** *The schematic shown in this document is not intended to be used as a reference for mass production. Any usage in an application design is in sole responsibility of the customer.*

The following components described in the schematic are not provided with the board:

- SMA connectors
  - CN10
  - CN11
- Jumper JP16
- Oscillator OSC1
- Capacitors
  - C1
  - C2
- Resistances
  - R1
  - R2
  - R12
- Mainboard Connector CN4

The following components described in the schematic are provided with but not mounted on the board:

- Standard 4mm power lab sockets
  - CN21
  - CN22
  - CN23



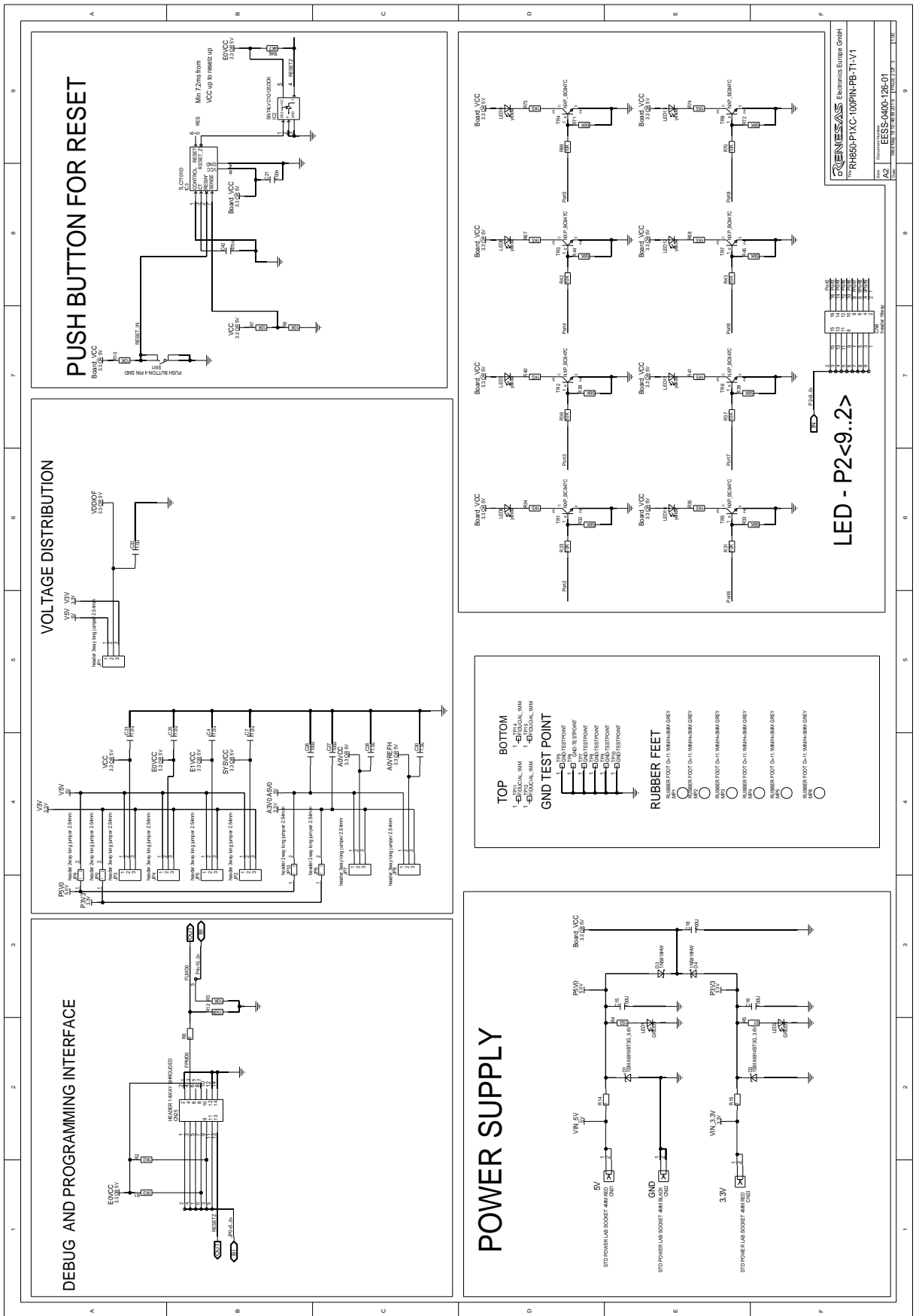

# TO MAIN BOARD CONNECTORS

CONNECTOR3

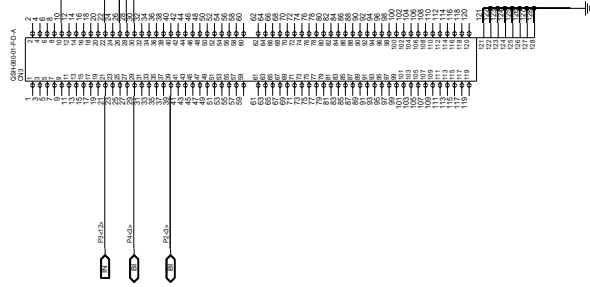

CONNECTOR1

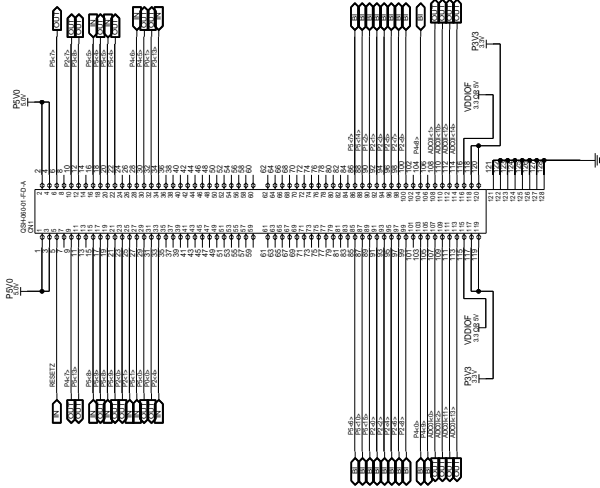

CONNECTOR2

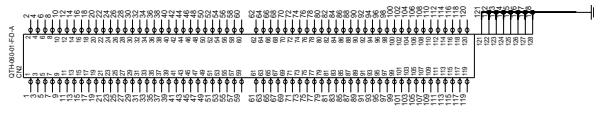

CONNECTOR4

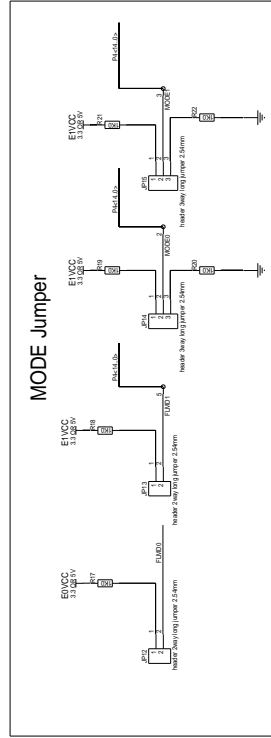
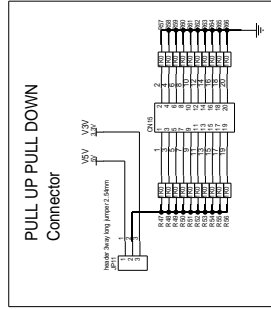
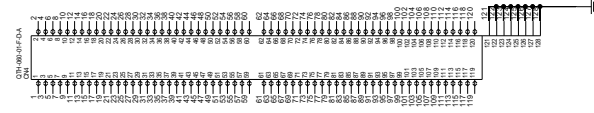

**RENESAS** Electronics Europe GmbH  
 RH850-P1XC-100PIN-PB-11-V1  
 Rev. 1.0  
 E55-0401-126-01  
 11/09

---

## Chapter 11 Revision History

The table provides information about the major changes of the document versions.

Date	Version	Description
2016-08-08	1.0	Initial release

---

## Notice

1. All information included in this document is current as of the date this document is issued. Such information, however, is subject to change without any prior notice. Before purchasing or using any Renesas Electronics products listed herein, please confirm the latest product information with a Renesas Electronics sales office. Also, please pay regular and careful attention to additional and different information to be disclosed by Renesas Electronics such as that disclosed through our website.
2. Renesas Electronics does not assume any liability for infringement of patents, copyrights, or other intellectual property rights of third parties by or arising from the use of Renesas Electronics products or technical information described in this document. No license, express, implied or otherwise, is granted hereby under any patents, copyrights or other intellectual property rights of Renesas Electronics or others.
3. You should not alter, modify, copy, or otherwise misappropriate any Renesas Electronics product, whether in whole or in part.
4. Descriptions of circuits, software and other related information in this document are provided only to illustrate the operation of semiconductor products and application examples. You are fully responsible for the incorporation of these circuits, software, and information in the design of your equipment. Renesas Electronics assumes no responsibility for any losses incurred by you or third parties arising from the use of these circuits, software, or information.
5. When exporting the products or technology described in this document, you should comply with the applicable export control laws and regulations and follow the procedures required by such laws and regulations. You should not use Renesas Electronics products or the technology described in this document for any purpose relating to military applications or use by the military, including but not limited to the development of weapons of mass destruction. Renesas Electronics products and technology may not be used for or incorporated into any products or systems whose manufacture, use, or sale is prohibited under any applicable domestic or foreign laws or regulations.
6. Renesas Electronics has used reasonable care in preparing the information included in this document, but Renesas Electronics does not warrant that such information is error free. Renesas Electronics assumes no liability whatsoever for any damages incurred by you resulting from errors in or omissions from the information included herein.
7. Renesas Electronics products are classified according to the following three quality grades: "Standard", "High Quality", and "Specific". The recommended applications for each Renesas Electronics product depends on the product's quality grade, as indicated below. You must check the quality grade of each Renesas Electronics product before using it in a particular application. You may not use any Renesas Electronics product for any application categorized as "Specific" without the prior written consent of Renesas Electronics. Further, you may not use any Renesas Electronics product for any application for which it is not intended without the prior written consent of Renesas Electronics. Renesas Electronics shall not be in any way liable for any damages or losses incurred by you or third parties arising from the use of any Renesas Electronics product for an application categorized as "Specific" or for which the product is not intended where you have failed to obtain the prior written consent of Renesas Electronics.

The quality grade of each Renesas Electronics product is "Standard" unless otherwise expressly specified in a Renesas Electronics data sheets or data books, etc.

"Standard": Computers; office equipment; communications equipment; test and measurement equipment; audio and visual equipment; home electronic appliances; machine tools; personal electronic equipment; and industrial robots.

"High Quality": Transportation equipment (automobiles, trains, ships, etc.); traffic control systems; anti-disaster systems; anti-crime systems; safety equipment; and medical equipment not specifically designed for life support.

"Specific": Aircraft; aerospace equipment; submersible repeaters; nuclear reactor control systems; medical equipment or systems for life support (e.g. artificial life support devices or systems), surgical implantations, or healthcare intervention (e.g. excision, etc.), and any other applications or purposes that pose a direct threat to human life.

8. You should use the Renesas Electronics products described in this document within the range specified by Renesas Electronics, especially with respect to the maximum rating, operating supply voltage range, movement power voltage range, heat radiation characteristics, installation and other product characteristics. Renesas Electronics shall have no liability for malfunctions or damages arising out of the use of Renesas Electronics products beyond such specified ranges.

- 
9. Although Renesas Electronics endeavors to improve the quality and reliability of its products, semiconductor products have specific characteristics such as the occurrence of failure at a certain rate and malfunctions under certain use conditions. Further, Renesas Electronics products are not subject to radiation resistance design. Please be sure to implement safety measures to guard them against the possibility of physical injury, and injury or damage caused by fire in the event of the failure of a Renesas Electronics product, such as safety design for hardware and software including but not limited to redundancy, fire control and malfunction prevention, appropriate treatment for aging degradation or any other appropriate measures. Because the evaluation of microcomputer software alone is very difficult, please evaluate the safety of the final products or system manufactured by you.
  10. Please contact a Renesas Electronics sales office for details as to environmental matters such as the environmental compatibility of each Renesas Electronics product. Please use Renesas Electronics products in compliance with all applicable laws and regulations that regulate the inclusion or use of controlled substances, including without limitation, the EU RoHS Directive. Renesas Electronics assumes no liability for damages or losses occurring as a result of your noncompliance with applicable laws and regulations.
  11. This document may not be reproduced or duplicated, in any form, in whole or in part, without prior written consent of Renesas Electronics.
  12. Please contact a Renesas Electronics sales office if you have any questions regarding the information contained in this document or Renesas Electronics products, or if you have any other inquiries.

(Note 1) "Renesas Electronics" as used in this document means Renesas Electronics Corporation and also includes its majority-owned subsidiaries.

(Note 2) "Renesas Electronics product(s)" means any product developed or manufactured by or for Renesas Electronics.



Renesas Electronics Corporation  
[www.renesas.com](http://www.renesas.com)