



RR Series Power Relays

Key features:

- SPDT through 3PDT, 10A contacts
- Midget power type relays
- Available in pin and blade terminal styles.
- Options include an indicator, check button for test operations and side flange.
- DIN rail, surface and panel mount sockets are available for a wide a variety of mounting applications.



Part Number Selection

Contact	Model	Part Number		Coil Voltage Code (Standard Stock Items in Bold)
		Pin Terminal	Blade Terminal*	
	Standard	—	RR1BA-U <input type="checkbox"/>	AC6V, AC12V, AC24V, AC110V, AC120V , AC240V, DC6V, DC12V, DC24V , DC48V, DC110V
	With Indicator		RR1BA-UL <input type="checkbox"/>	
	With Check Button		RR1BA-UC <input type="checkbox"/>	
	With Indicator and Check Button		RR1BA-ULC <input type="checkbox"/>	
	Side Flange Model		RR1BA-US <input type="checkbox"/>	
	Standard	RR2P-U <input type="checkbox"/>	RR2BA-U <input type="checkbox"/>	
	With Indicator	RR2P-UL <input type="checkbox"/>	RR2BA-UL <input type="checkbox"/>	
	With Check Button	RR2P-UC <input type="checkbox"/>	RR2BA-UC <input type="checkbox"/>	
	With Indicator and Check Button	RR2P-ULC <input type="checkbox"/>	RR2BA-ULC <input type="checkbox"/>	
	Side Flange Model	—	RR2BA-US <input type="checkbox"/>	
	Standard	RR3PA-U <input type="checkbox"/>	RR3B-U <input type="checkbox"/>	
	With Indicator	RR3PA-UL <input type="checkbox"/>	RR3B-UL <input type="checkbox"/>	
	With Check Button	RR3PA-UC <input type="checkbox"/>	RR3B-UC <input type="checkbox"/>	
	With Indicator and Check Button	RR3PA-ULC <input type="checkbox"/>	RR3B-ULC <input type="checkbox"/>	
	Side Flange Model	—	RR3B-US <input type="checkbox"/>	

 *Blade type not TUV tested or CE marked.
Side flange model mounts directly to panel with no socket required.

Ordering Information
When ordering, specify the Part No. and coil voltage code:

(example) **RR3B-U** **AC120V**
Part No. Coil Voltage Code

Sockets

Relays	Standard DIN Rail Mount	Finger-safe DIN Rail Mount	Through Panel Mount
RR2P	SR2P-05 SR2P-06	SR2P-05C	SR2P-51
RR3PA	SR3P-05 SR3P-06	SR3P-05C	SR3P-51
RR1BA RR2BA RR3B	SR3B-05	—	SR3B-51



 All DIN rail mount sockets shown here can be mounted using DIN rail BNDN1000.

Switches & Pilot Lights

Signaling Lights

Relays & Sockets



Timers

Contactors





Terminal Blocks

Circuit Breakers

Hold Down Springs & Clips

Appearance	Description	Relay	For DIN Mount Socket	For Through Panel & PCB Mount Socket
	Pullover Wire Spring	RR2P	SR2B-02F1	SR3P-01F1
		RR3PA	SR3B-02F1	
		RR1BA, RR2BA, RR3B	SR3B-02F1	SR3B-02F1
	Leaf Spring (side latch)	RR2P, RR3PA	SFA-203	—

Accessories

Item	Appearance	Use with	Part No.	Remarks
Aluminum DIN Rail (1 meter length)		All DIN rail sockets	BNDN1000	The BNDN1000 is designed to accommodate DIN mount sockets. Made of durable extruded aluminum, the BNDN1000 measures 0.413 (10.5mm) in height and 1.37 (35mm) in width (DIN standard). Standard length is 39" (1,000mm).
DIN Rail End Stop		DIN rail	BNL5	9.1 mm wide.
Replacement Hold-Down Spring Anchor		Horseshoe clip for sockets SR3B-05, SR2P-06, SR3P-06	Y778-011	For use on DIN rail mount socket when using pullover wire hold down spring. 2 pieces included with each socket.
		Chair clip for sockets SR2P-05(C), SR3P-05(C)	Y703-102	

Specifications

Contact Material	Silver		
Contact Resistance ¹	30 mΩ maximum		
Minimum Applicable Load	1V DC, 10 mA		
Operating Time ²	25 ms maximum		
Release Time ²	25 ms maximum		
Power Consumption (approx.)	AC: 3 VA (50 Hz), 2.5 VA (60 Hz) DC: 1.5W		
Insulation Resistance	100 MΩ minimum (500V DC megger)		
Dielectric Strength	Pin Terminal	Between live and dead parts:	1500V AC, 1 minute
		Between contact and coil:	1500V AC, 1 minute
		Between contacts of different poles:	1500V AC, 1 minute
		Between contacts of the same pole:	1000V AC, 1 minute
	Blade Terminal	Between live and dead parts:	2000V AC, 1 minute
		Between contact and coil:	2000V AC, 1 minute
		Between contacts of different poles:	2000V AC, 1 minute
		Between contacts of the same pole:	1000V AC, 1 minute
Operating Frequency	Electrical:	1800 operations/h maximum	
	Mechanical:	18,000 operations/h maximum	
Vibration Resistance	Damage limits:	10 to 55 Hz, amplitude 0.5 mm	
	Operating extremes:	10 to 55 Hz, amplitude 0.5 mm	
Shock Resistance	Damage limits:	1000 m/s ² (100g)	
	Operating extremes:	100 m/s ² (10G)	
Mechanical Life	10,000,000 operations		
Electrical Life	200,000 operations (220V AC, 5A)		
Operating Temperature ³	-25 to +40°C (no freezing)		
Operating Humidity	5 to 85% RH (no condensation)		
Weight (approx.) (Standard type)	RR2P: 90g, RR3PA: 96g, RR1BA/RR2BA/RR3B: 82g		



1. Measured using 5V DC, 1A voltage drop method
2. Measured at the rated voltage (at 20°C), excluding contact bouncing
3. For use under different temperature conditions, refer to Continuous Load Current vs. Operating Temperature Curve.

Coil Ratings

Rated Voltage (V)	Rated Current (mA) ±15% (at 20°C)		Coil Resistance (Ω) ±10% (at 20°C)	Operating Characteristics (values at 20°C)		
	50 Hz	60 Hz		Maximum Continuous Applied Voltage	Pickup Voltage	Dropout Voltage
AC (50/60 Hz)	6	490	420	110%	80% maximum	30% minimum
	12	245	210			
	24	121	105			
	110	27	23			
	120	24	20.5			
	240	12.1	10.5			
DC	6	240		110%	80% maximum	10% minimum
	12	120				
	24	60				
	48	30				
	110	13				

Contact Ratings

Maximum Contact Capacity					
Continuous Current	Allowable Contact Power		Rated Load		
	Resistive Load	Inductive Load	Voltage (V)	Res. Load	Ind. Load
			10A	1650VA AC 300W DC	1100VA AC 150W DC



Note: Inductive load for the rated load — $\cos \phi = 0.3$, L/R = 7 ms

TÜV Ratings

Voltage	
240V AC	10A
30V DC	10A



AC: $\cos \phi = 1.0$, DC: L/R = 0 ms

UL Ratings

Voltage	Resistive	General use	Horse Power Rating
240V AC	10A	7A	1/3 HP
120V AC	10A	7.5A	1/4 HP
30V DC	10A	7A	—

CSA Ratings

Voltage	Resistive	General use
240V AC	10A	7A
120V AC	10A	7.5A
100V DC	—	0.5A
30V DC	10A	7.5A

Socket Specifications

	Relays	Terminal	Electrical Rating	Wire Size	Torque
DIN Rail Sockets	SR2P-05	M3 screw with captive wire clamp	300V, 10A	Maximum 2 - #12 AWG	9 - 11.5in•lbs
	SR2P-05C	M3 screw with captive wire clamp, fingersafe	300V, 10A	Maximum 2 - #12 AWG	9 - 11.5in•lbs
	SR2P-06	M3 screw with captive wire clamp	300V, 10A	Maximum 2 - #12 AWG	9 - 11.5in•lbs
	SR3P-05	M3 screw with captive wire clamp	300V, 10A	Maximum 2 - #12 AWG	9 - 11.5in•lbs
	SR3P-05C	M3 screw with captive wire clamp, fingersafe	300V, 10A	Maximum 2 - #12 AWG	9 - 11.5in•lbs
	SR3P-06	M3 screw with captive wire clamp	300V, 10A	Maximum 2 - #12 AWG	9 - 11.5in•lbs
	SR3B-05	M3 screw with captive wire clamp	300V, 15A (10A)* (*CSA rating)	Maximum 2 - #12 AWG	9 - 11.5in•lbs
Through Panel Mount Sockets	SR2P-51	Solder	300V, 10A	—	—
	SR3P-51	Solder	300V, 10A	—	—
	SR3B-51	Solder	300V, 10A	—	—

Characteristics (Reference Data)

Electrical Life Curves

AC Load

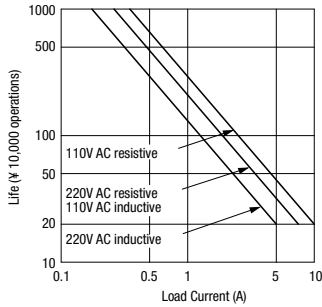

DC Load

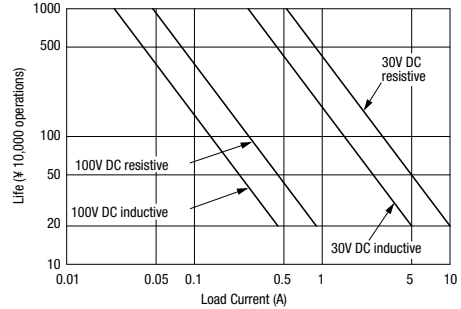

Maximum Switching Capacity

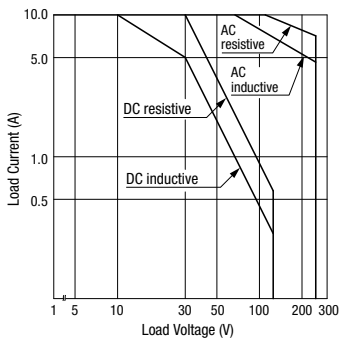

Continuous Load Current vs. Operating Temperature Curve (Standard Type, With Check Button, and Side Flange Type)

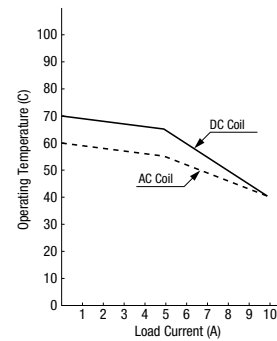

Internal Connection (View from Bottom)

Standard Type

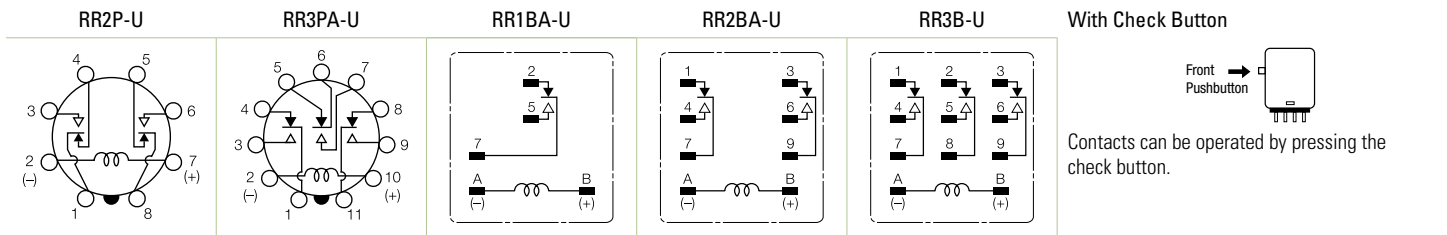

With Indicator (-UL type)

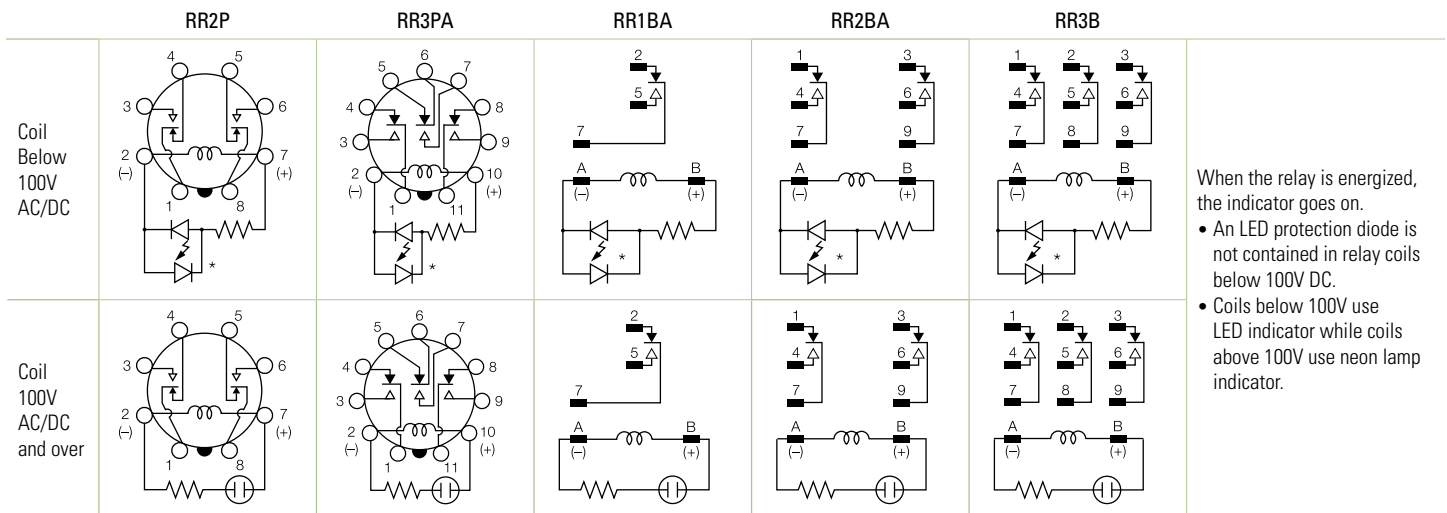

Switches & Pilot Lights

Signaling Lights

Relays & Sockets

Timers

Contactors

Terminal Blocks

Circuit Breakers

Dimensions (mm)

RR2P-U/RR2P-UL

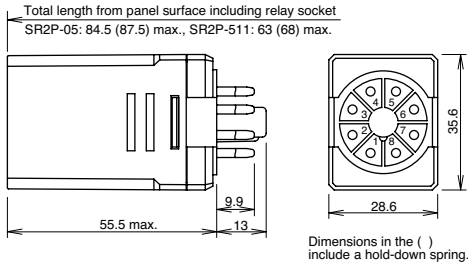

RR3PA-U/RR3PA-UL

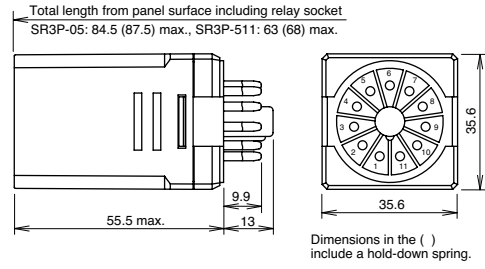

RR1BA-U/RR2BA-UL/RR2BA-U
RR2BA-UL/RR3B-U/RR3B-UL

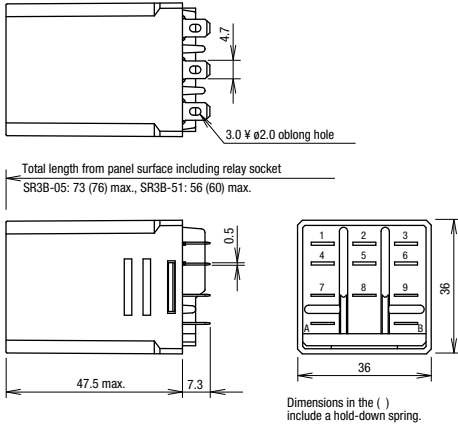

RR1BA-US/RR2BA-US/RR3B-US

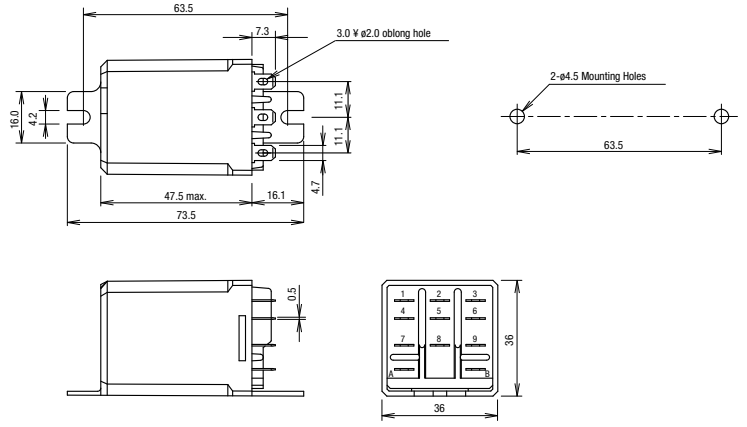

Standard DIN Rail Mount Sockets

SR2P-05

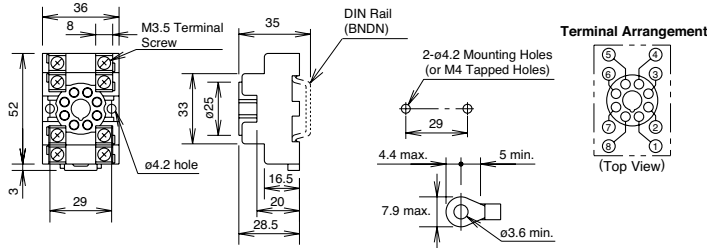

SR2P-06

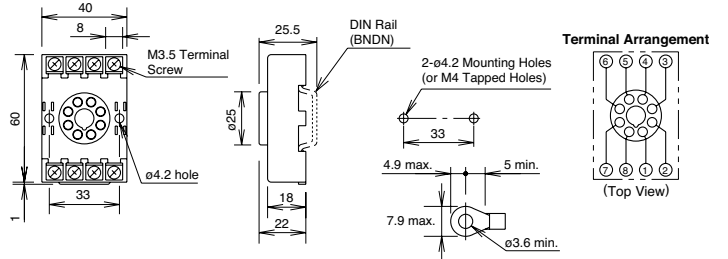

SR3P-05

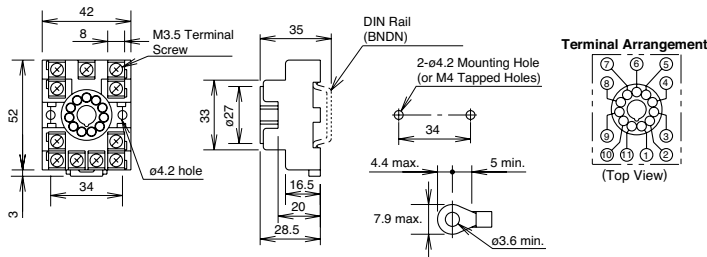

SR3P-06

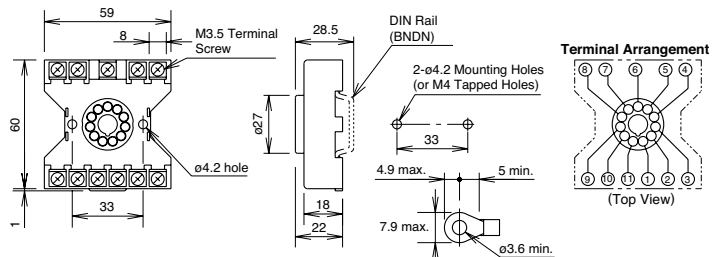

Switches & Pilot Lights

Signaling Lights

Relays & Sockets

Timers

Contactors

Terminal Blocks

Circuit Breakers

Standard DIN Rail Mount Sockets

SR3B-05

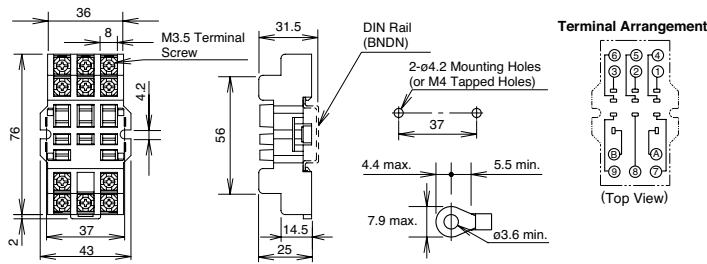

Finger-safe DIN Rail Mount Sockets

SR2P-05C

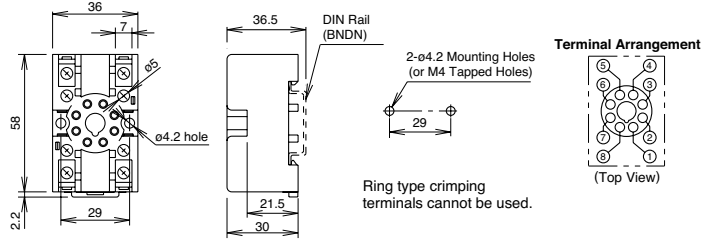

SR3P-05C

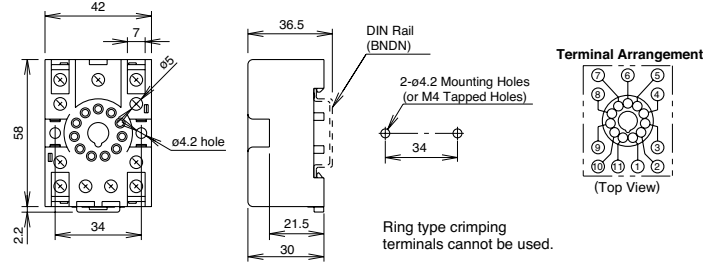

Through Panel Mount Socket

SR2P-51

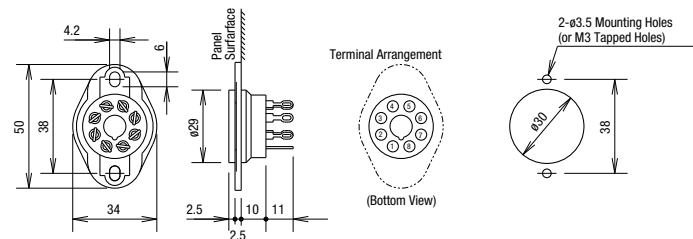

SR3P-51

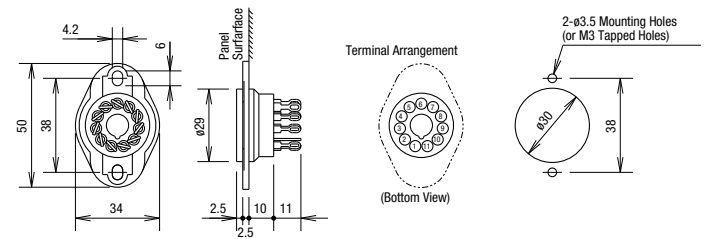

SR3B-51

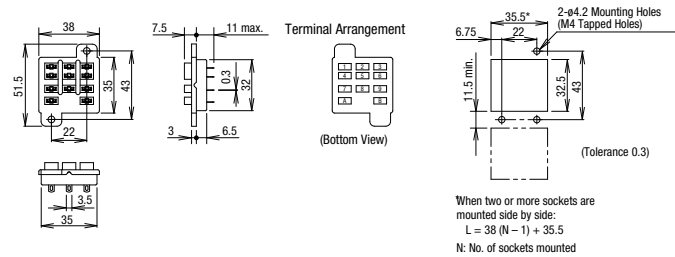

Switches & Pilot Lights

Signaling Lights

Relays & Sockets

Timers

Contactors

Terminal Blocks

Circuit Breakers