

## LOW VOLTAGE OPERATION LOW OFFSET VOLTAGE DUAL C-MOS OPERATIONAL AMPLIFIER

### ■ GENERAL DESCRIPTION

The NJU7094, 95 and 96 are single supply dual C-MOS operational amplifiers featuring a low operating voltage from 1V, low operating current of 15 $\mu$ A/circuit (7094 typ.), 80 $\mu$ A/circuit (7095 typ.), 200 $\mu$ A/circuit (7096 typ.) and low offset voltage 2mV (max.). They also have a low input bias current of 1pA (typ.) and input voltage range from ground, which can provide a ground sensing, and rail-to-rail output swing in both rails. The NJU7094, 7095 and 7096 are available in a wide variety of 8-lead packages, dual-in-line DIP8, surface-mount SOP8 (DMP8), SSOP8, MSOP8 (VSP8), MSOP8 (TVSP8). The combination of these features makes them ideal for a variety of portable devices.

### ■ PACKAGE OUTLINE

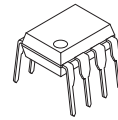

NJU709XD  
(DIP8)



NJU709XM  
(DMP8)

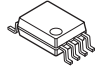

NJU709XV  
(SSOP8)



NJU709XR  
(MSOP8 (VSP8))



NJU709XRB1  
(MSOP8 (TVSP8))

### ■ FEATURES

- Single-Power-Supply
- Low Offset Voltage ( $V_{IO}=4\text{mV max}$ )
- Wide Operating Voltage ( $V_{DD}=1 \text{ to } 5.5\text{V}$ )
- Wide Output Swing Range ( $V_{OM}=2.9\text{V min. @ } 3.0\text{V}$ )
- Low Operating Current
- Low Bias Current ( $I_{IB}=1\text{pA typ.}$ )
- Compensation Capacitor Incorporated
- Package Outline  
DIP8, DMP8, SSOP8  
MSOP8 (VSP8) MEET JEDEC MO-187-DA  
MSOP8 (TVSP8) MEET JEDEC MO-187-DA/THIN TYPE

### ■ PIN CONFIGURATION

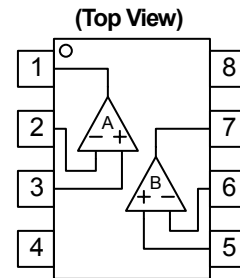

- 1: OUT 1
- 2: IN -1
- 3: IN +1
- 4: VSS
- 5: IN +2
- 6: IN -2
- 7: OUT 2
- 8: VDD

- C-MOS Technology

### ■ LINE-UP

( $T_a=25^\circ\text{C}, V_{DD}=3.0\text{V}, \text{Per Circuit}$ )

PARAMETER	NJU7094	NJU7095	NJU7096	UNIT
Operating Current	15	80	200	$\mu\text{A}$ (typ)
Slew Rate	0.1	1.0	2.4	$\text{V}/\mu\text{s}$ (typ)
Unity Gain Bandwidth	0.2	1.0	1.0	$\text{MHz}$ (typ)

### ■ EQUIVALENT CIRCUIT

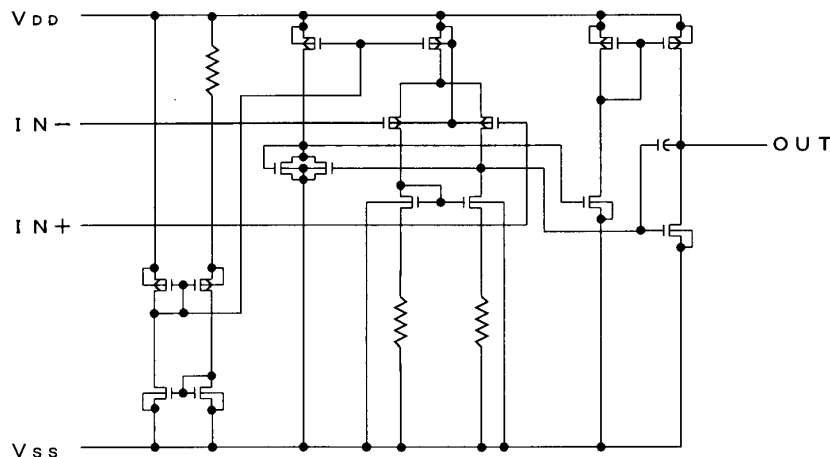

# NJU7094/95/96

## ■ ABSOLUTE MAXIMUM RATINGS

( Ta=25°C )

PARAMETER	SYMBOL	RATINGS	UNIT
Supply Voltage	V <sub>DD</sub>	7	V
Differential Input Voltage	V <sub>ID</sub>	± 7 ( note1 )	V
Common Mode Input Voltage	V <sub>IC</sub>	-0.3~7	V
Power Dissipation	P <sub>D</sub>	( DIP8 ) 500 ( DMP8 ) 300 ( SSOP8 ) 250 ( MSOP8 (VSP8) ) 320 ( MSOP8 (TVSP8) ) 320	mW
Operating Temperature Range	T <sub>opr</sub>	-40~+85	°C
Storage Temperature Range	T <sub>stg</sub>	-55~+125	°C

( note1 ) If the supply voltage ( V<sub>DD</sub> ) is less than 7V, the input voltage must not over the V<sub>DD</sub> level though 7V is limit specified.

( note2 ) Decoupling capacitor should be connected between V<sub>DD</sub> and V<sub>SS</sub> for the stable operation.

## ■ ELECTRICAL CHARACTERISTICS

### NJU7094

( Ta=25°C, V<sub>DD</sub>=3.0V, R<sub>L</sub>=∞ )

PARAMETER	SYMBOL	TEST CONDITION	MIN.	TYP.	MAX.	UNIT
Input Offset Voltage	V <sub>IO</sub>	V <sub>IN</sub> =1/2V <sub>DD</sub>	-	-	4	mV
Input Offset Current	I <sub>IO</sub>		-	1	-	pA
Input Bias Current	I <sub>IB</sub>		-	1	-	pA
Input Impedance	R <sub>IN</sub>		-	1	-	TΩ
Large Signal Voltage Gain	A <sub>VD</sub>		60	70	-	dB
Input Common Mode Voltage Range	V <sub>ICM</sub>		0~2.5	-	-	V
Maximum Output Swing Voltage	V <sub>OM1</sub>	R <sub>L</sub> =1MΩ	V <sub>DD</sub> -0.1	-	-	V
	V <sub>OM2</sub>	R <sub>L</sub> =1MΩ	-	-	V <sub>SS</sub> +0.1	V
Common Mode Rejection Ratio	CMR	V <sub>IN</sub> =1/2V <sub>DD</sub>	55	65	-	dB
Supply Voltage Rejection Ratio	SVR	V <sub>DD</sub> =1.5~5.5V	60	70	-	dB
Operating Current	I <sub>DD</sub>	Per Circuit	-	15	25	μA
Slew Rate	SR		-	0.1	-	V/μs
Unity Gain Bandwidth	F <sub>t</sub>	A <sub>v</sub> =40dB, C <sub>L</sub> =10pF	-	0.2	-	MHz

( note3 ) The source current is less than 2.9μA ( at V<sub>OM</sub>/R<sub>L</sub>=2.9V/1MΩ ).

## NJU7095

( Ta=25°C, V<sub>DD</sub>=3.0V, R<sub>L</sub>=∞ )

PARAMETER	SYMBOL	TEST CONDITION	MIN.	TYP.	MAX.	UNIT
Input Offset Voltage	V <sub>IO</sub>	V <sub>IN</sub> =1/2V <sub>DD</sub>	-	-	4	mV
Input Offset Current	I <sub>IO</sub>		-	1	-	pA
Input Bias Current	I <sub>IB</sub>		-	1	-	pA
Input Impedance	R <sub>IN</sub>		-	1	-	TΩ
Large Signal Voltage Gain	A <sub>VD</sub>		60	70	-	dB
Input Common Mode Voltage Range	V <sub>ICM</sub>		0~2.5	-	-	V
Maximum Output Swing Voltage	V <sub>OM1</sub>	R <sub>L</sub> =100kΩ	V <sub>DD</sub> -0.1	-	-	V
	V <sub>OM2</sub>	R <sub>L</sub> =100kΩ	-	-	V <sub>SS</sub> +0.1	V
Common Mode Rejection Ratio	CMR	V <sub>IN</sub> =1/2V <sub>DD</sub>	55	65	-	dB
Supply Voltage Rejection Ratio	SVR	V <sub>DD</sub> =1.5~5.5V	60	70	-	dB
Operating Current	I <sub>DD</sub>	Per Circuit	-	80	160	μA
Slew Rate	SR		-	1.0	-	V/μs
Unity Gain Bandwidth	F <sub>t</sub>	A <sub>v</sub> =40dB, C <sub>L</sub> =10pF	-	1.0	-	MHz

( note4 ) The source current is less than 29μA ( at V<sub>OM</sub>/R<sub>L</sub>=2.9V/100kΩ ).

## NJU7096

( Ta=25°C, V<sub>DD</sub>=3.0V, R<sub>L</sub>=∞ )

PARAMETER	SYMBOL	TEST CONDITION	MIN.	TYP.	MAX.	UNIT
Input Offset Voltage	V <sub>IO</sub>	V <sub>IN</sub> =1/2V <sub>DD</sub>	-	-	4	mV
Input Offset Current	I <sub>IO</sub>		-	1	-	pA
Input Bias Current	I <sub>IB</sub>		-	1	-	pA
Input Impedance	R <sub>IN</sub>		-	1	-	TΩ
Large Signal Voltage Gain	A <sub>VD</sub>		60	70	-	dB
Input Common Mode Voltage Range	V <sub>ICM</sub>		0~2.5	-	-	V
Maximum Output Swing Voltage	V <sub>OM1</sub>	R <sub>L</sub> =50kΩ	V <sub>DD</sub> -0.1	-	-	V
	V <sub>OM2</sub>	R <sub>L</sub> =50kΩ	-	-	V <sub>SS</sub> +0.1	V
Common Mode Rejection Ratio	CMR	V <sub>IN</sub> =1/2V <sub>DD</sub>	55	65	-	dB
Supply Voltage Rejection Ratio	SVR	V <sub>DD</sub> =1.5~5.5V	60	70	-	dB
Operating Current	I <sub>DD</sub>	Per Circuit	-	200	400	μA
Slew Rate	SR		-	2.4	-	V/μs
Unity Gain Bandwidth	F <sub>t</sub>	A <sub>v</sub> =40dB, C <sub>L</sub> =10pF	-	1.0	-	MHz

( note5 ) The source current is less than 58μA ( at V<sub>OM</sub>/R<sub>L</sub>=2.9V/50kΩ ).

# NJU7094/95/96

## ■ TYPICAL CHARACTERISTICS

(1) NJU7094

Output Voltage vs. Output Current (SOURCE)

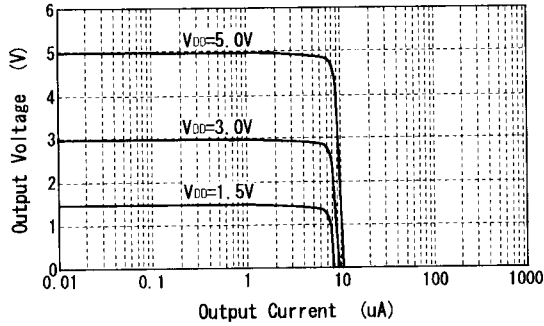

Output Voltage vs. Output Current (SINK)

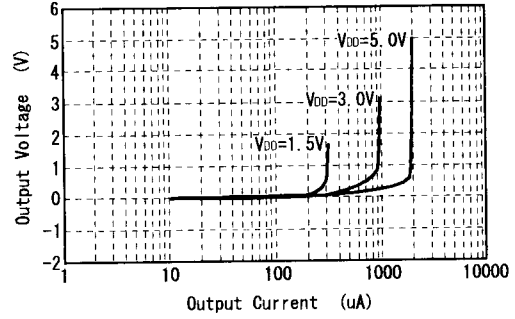

Offset Voltage vs. Operating Voltage

V<sub>IN</sub>=0.1V

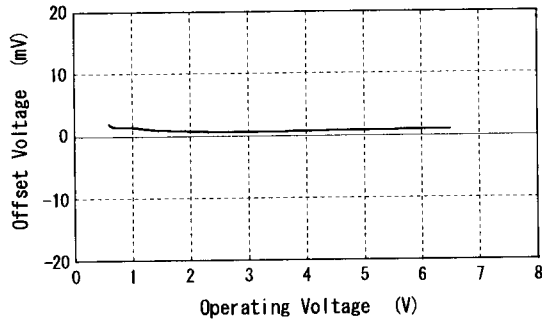

Offset Voltage vs. Input Voltage

V<sub>DD</sub>=3.0V

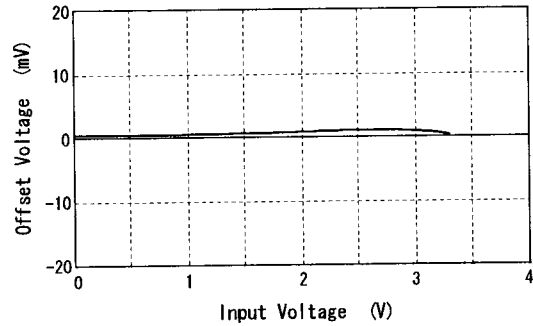

Operating Current vs. Operating Voltage

V<sub>IN</sub>=0.1V

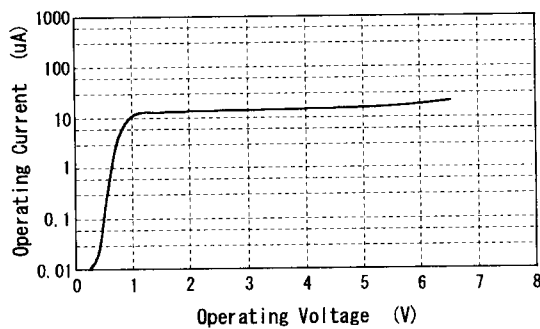

Output Current vs. Operating Voltage

V<sub>IN</sub>=0.1V

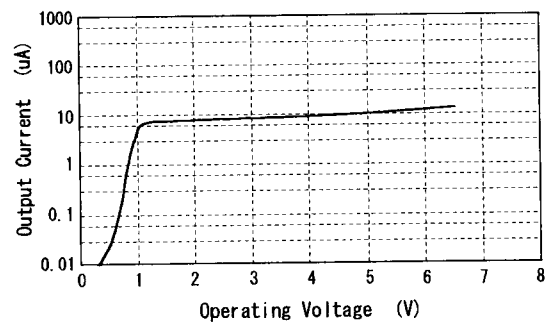

Maximum Output Swing Voltage vs. Load Resistance

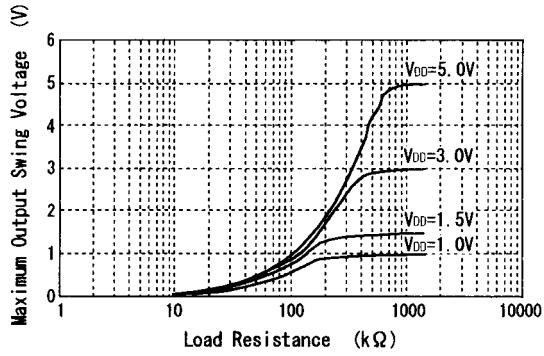

Maximum Output Swing Voltage vs. Frequency

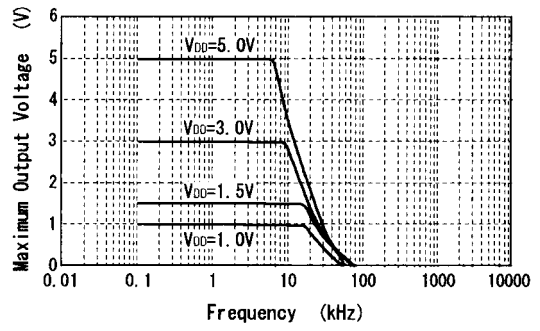

Voltage Gain-Phase vs. Frequency

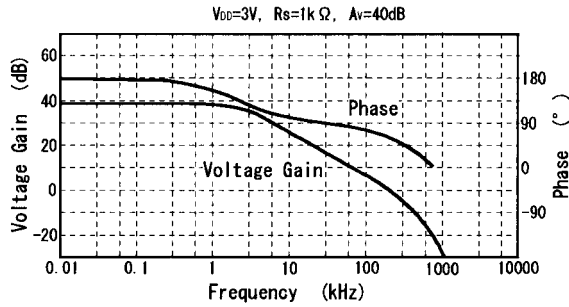

(2) NJU7095

Output Voltage vs. Output Current (SOURCE)

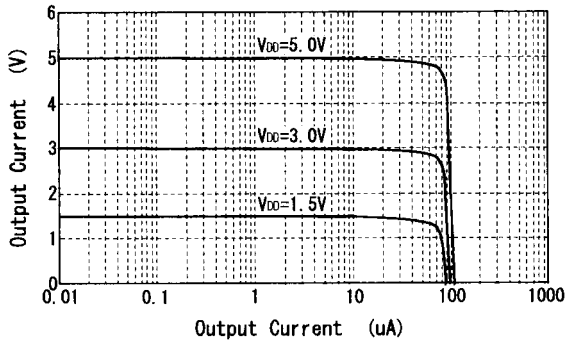

Output Voltage vs. Output Current (SINK)

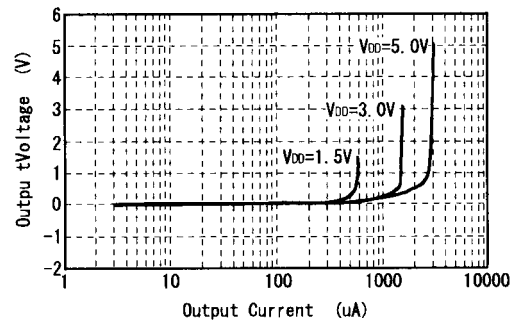

Offset Voltage vs. Operating Voltage

V<sub>IN</sub>=0.1V

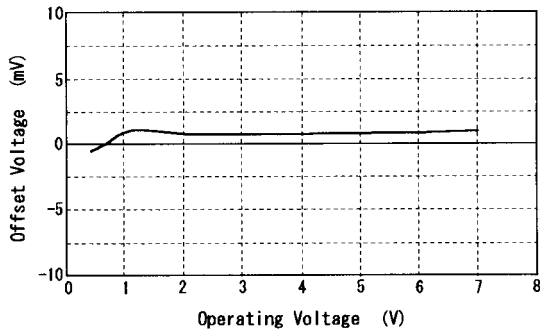

Offset Voltage vs. Input Voltage

V<sub>DD</sub>=3.0V

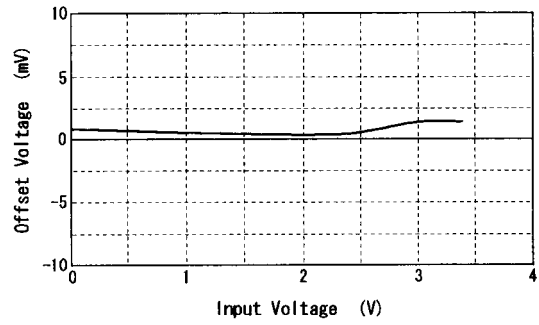

Operating Current vs. Operating Voltage

V<sub>IN</sub>=0.1V

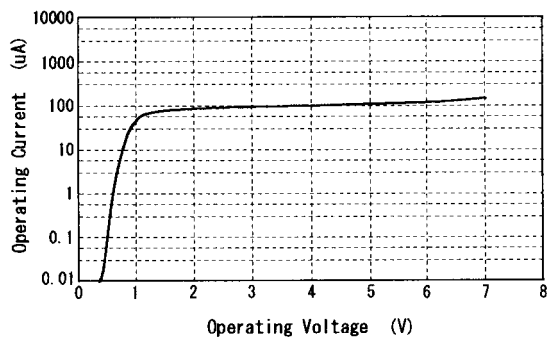

Output Current vs. Operating Voltage

V<sub>IN</sub>=0.1V

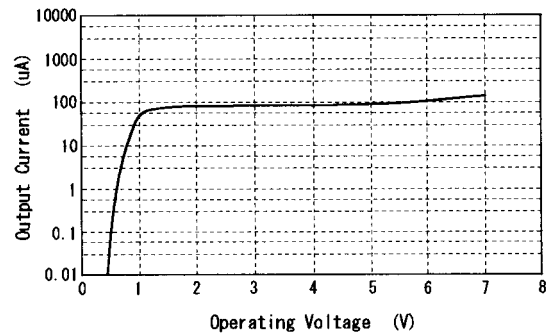

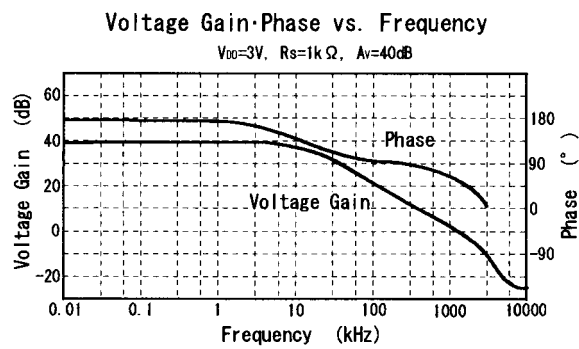
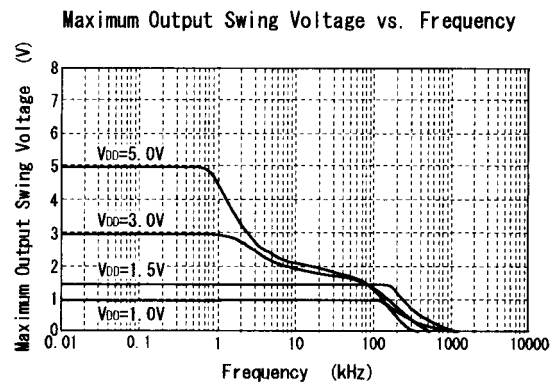
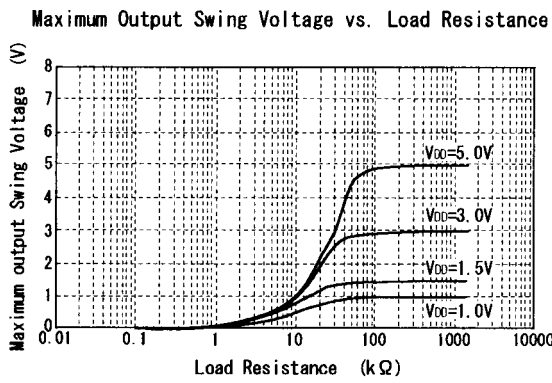

(3) NJU7096

Output Voltage vs. Output Current (SOURCE)

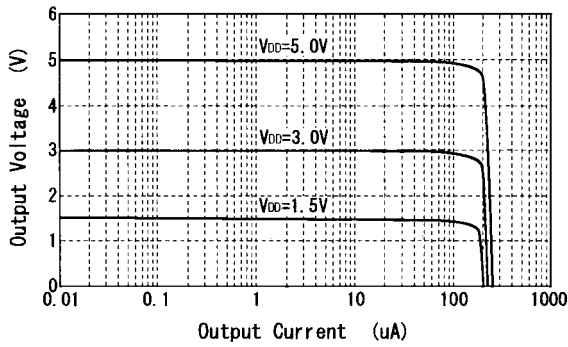

Output Voltage vs. Output Current (SINK)

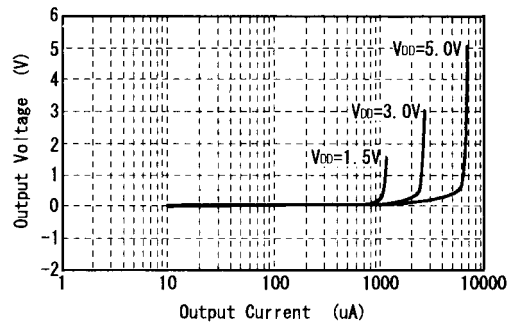

Offset Voltage vs. Operating Voltage

V<sub>IN</sub>=0.1V

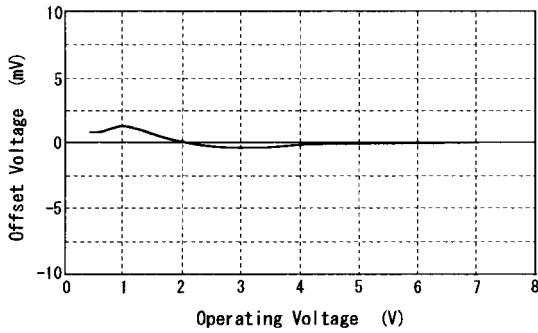

Offset Voltage vs. Input Voltage

V<sub>DD</sub>=3.0V

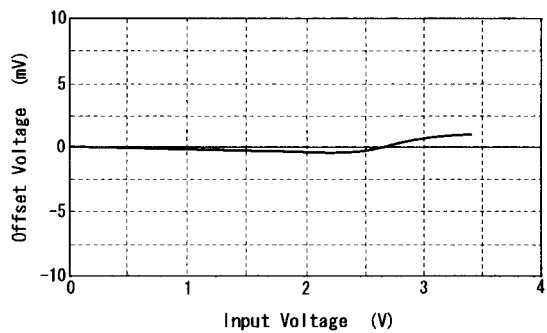

Operating Current vs. Operating Voltage

V<sub>IN</sub>=0.1V

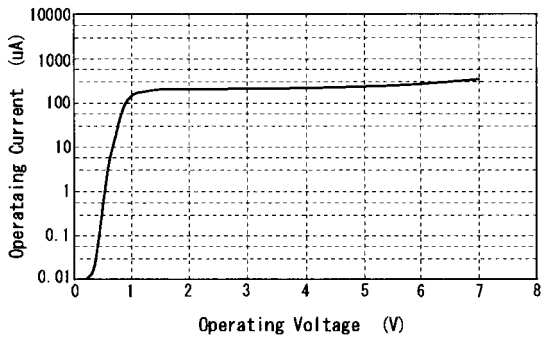

Output Current vs. Operating Voltage

V<sub>IN</sub>=0.1V

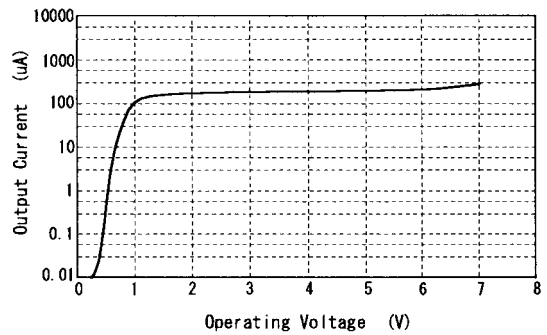



Maximum Output Swing Voltage vs. Load Resistance

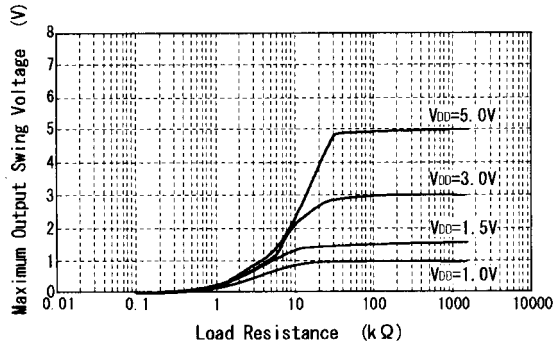

Maximum Output Swing Voltage vs. Frequency

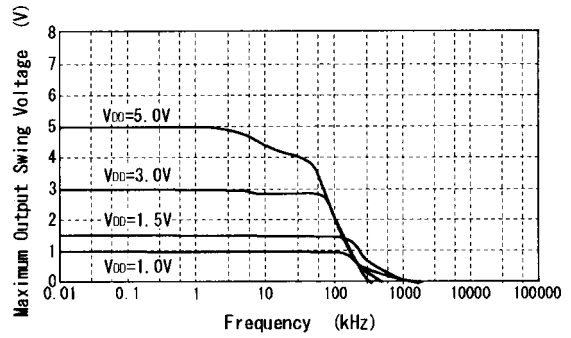

Voltage Gain-Phase vs. Frequency

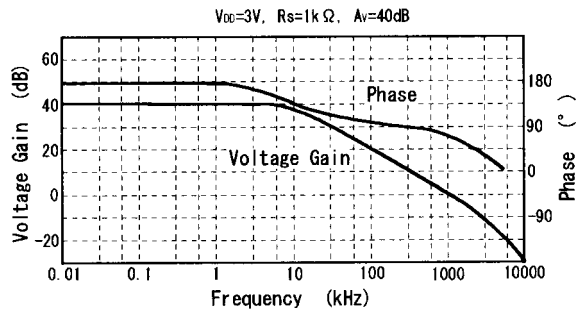

[CAUTION]

The specifications on this databook are only given for information, without any guarantee as regards either mistakes or omissions. The application circuits in this databook are described only to show representative usages of the product and not intended for the guarantee or permission of any right including the industrial rights.