

Description

- Standard 7 x 5mm crystal oscillator
Ceramic package with a seam sealed metal lid, hermetically sealed
- Model CFPS-73
- Model Issue number 12

Frequency Parameters

- Frequency 50.0MHz
- Frequency Stability $\pm 50.00\text{ppm}$
- Operating Temperature Range -40.00 to 85.00°C
- Ageing $\pm 3\text{ppm}$ per year max

Electrical Parameters

- Supply Voltage $3.3\text{V} \pm 10\%$
- Current Draw 25.00mA

Output Details

- Output Compatibility HCMOS
- Drive Capability 50pF max
- Rise and Fall Time 8.0ns max
- Duty Cycle 45/55

Output Control

- Logic '1' ($>70\%$ VS) to pad 1 enables oscillator output
Logic '0' ($<30\%$ VS) to pad 1 disables oscillator output; the oscillator output goes to the high impedance state
No connection to pad 1 enables oscillator output
Standby Current: $10\mu\text{A}$ max

Noise Parameters

- Phase Noise @125MHz (typical):
10Hz -54dBc
100Hz -92dBc
1kHz -130dBc
10kHz -149dBc
100kHz -159dBc
1MHz -163dBc
- RMS Phase Jitter @125MHz: 52fs typical

Environmental Parameters

- Shock: MIL-STD-202, Method 213, Condition E
- Vibration: MIL-STD-883, Method 2007, Condition A
- Storage Temperature Range: -55 to 125°C

Compliance

- RoHS Status (2011/65/EU) Compliant
- REACH Status Compliant
- MSL Rating (JDEC-STD-033): Not Applicable

Packaging Details

- Pack Style: Reel Tape & reel in accordance with EIA-481-D
Pack Size: 1,000
- *Alternative packing option available*

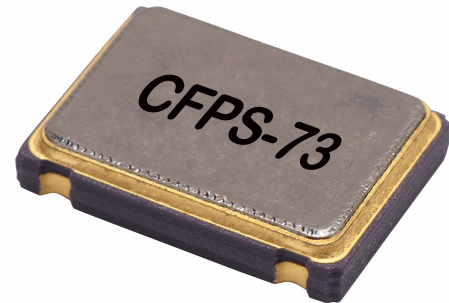
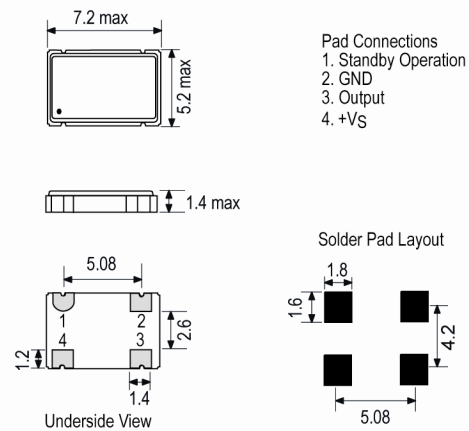
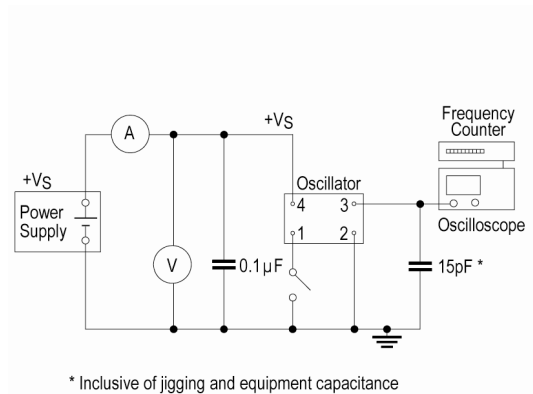
Outline (mm)

Test Circuit

Sales Office Contact Details:

 UK: +44 (0)1460 270200
 Germany: 0800 1808 443

 France: 0800 901 383
 USA: +1.760.318.2824

 Email: info@iqdfrequencyproducts.com
 Web: www.iqdfrequencyproducts.com

Wave Form



Phase Noise / Jitter



Sales Office Contact Details:

UK: +44 (0)1460 270200
 Germany: 0800 1808 443

France: 0800 901 383
 USA: +1.760.318.2824

Email: info@iqdfrequencyproducts.com
 Web: www.iqdfrequencyproducts.com