

Phototransistor, side view type

RPM-22PB

The RPM-22PB is a silicon phototransistor in a side-facing package. High sensitivity with $\phi 1.5$ lens.

●Applications

Optical control equipment
Receiver for sensors

●Features

- 1) High sensitivity.
- 2) Molded in plastic with a visible light filter.
(Filter out light 750nm or less)
- 3) Side-facing detector.

●External dimensions (Units : mm)

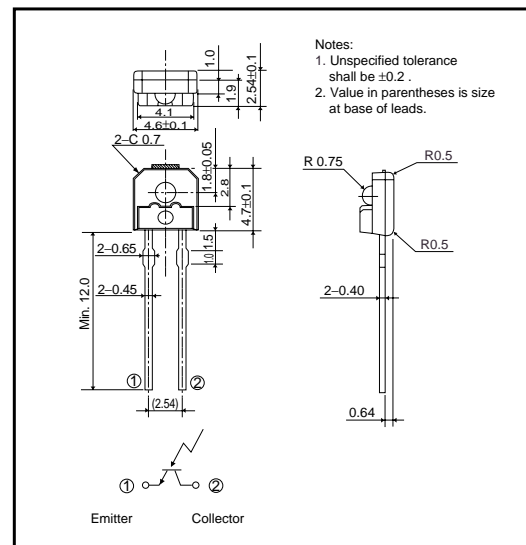

●Absolute maximum ratings (Ta=25°C)

| Parameter | Symbol | Limits | Unit |
|-----------------------------|-----------|----------|------|
| Collector-emitter voltage | V_{CE0} | 32 | V |
| Emitter-collector voltage | V_{ECO} | 5 | V |
| Collector current | I_C | 30 | mA |
| Collector power dissipation | P_C | 150 | mW |
| Operating temperature | T_{opr} | -25~+85 | °C |
| Storage temperature | T_{stg} | -30~+100 | °C |

●Electrical and optical characteristics (Ta=25°C)

| Parameter | Symbol | Min. | Typ. | Max. | Unit | Conditions |
|--------------------------------------|----------------|------|----------|------|---------|-------------------------------------|
| Light current | I_C | 0.48 | - | 1.94 | mA | $V_{CE}=5V, E=500Lx$ |
| Dark current | I_{CEO} | - | - | 0.5 | μA | $V_{CE}=10V$ (Black box) |
| Peak sensitivity wavelength | λ_P | - | 800 | - | nm | - |
| Collector-emitter saturation voltage | $V_{CE(sat)}$ | - | - | 0.4 | V | $I_C=0.1mA, E=500Lx$ |
| Half-angle | $\theta_{1/2}$ | - | ± 32 | - | deg | - |
| Response time | t_r-t_f | - | 10 | - | μs | $V_{CE}=5V, I_C=1mA, R_L=100\Omega$ |

Sensors

●Electrical and optical characteristic curves

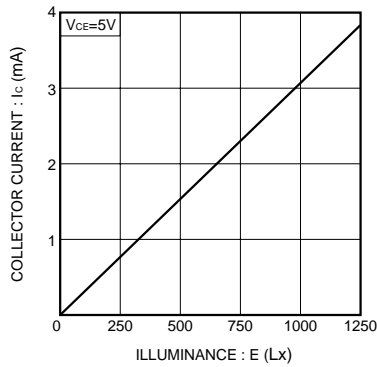

Fig.1 Collector current vs. emitting strength

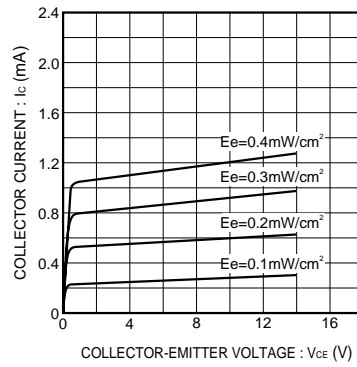

Fig.2 Output characteristics

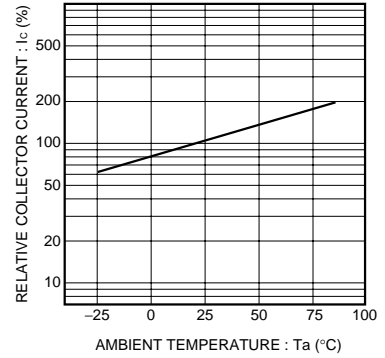

Fig.3 Relative output vs. ambient temperature

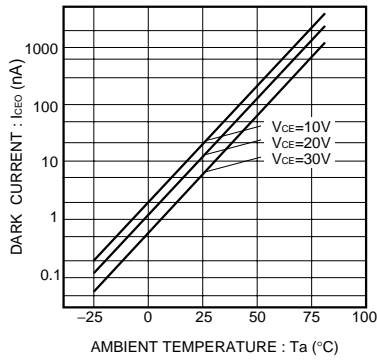

Fig.4 Dark current vs. ambient temperature

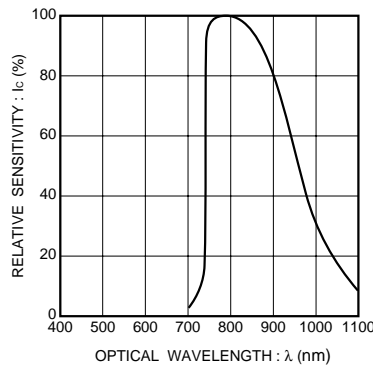

Fig.5 Spectral sensitivity

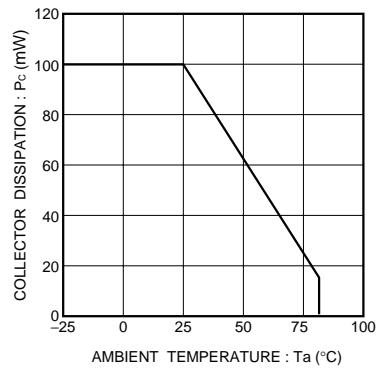

Fig.6 Collector dissipation vs. ambient temperature

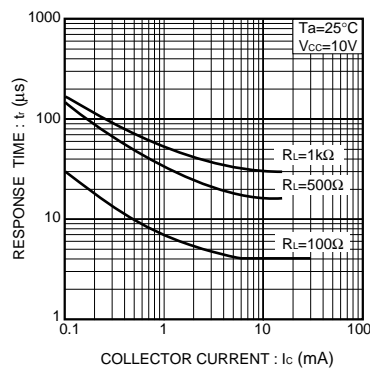

Fig.7 Response time vs. collector current

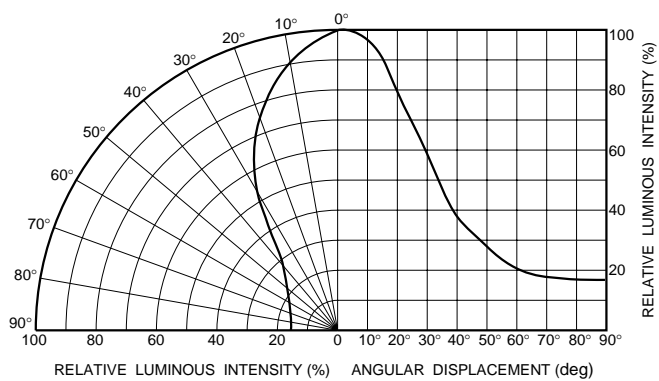

Fig.8 Directional pattern