

Reflective photosensor (photoreflector)

RPR-220

The RPR-220 is a reflective photosensor. The emitter is a GaAs infrared light emitting diode and the detector is a high-sensitivity, silicon planar phototransistor. A custom lamp was developed to enable the achievement of a smaller package than with conventional reflectors.

●Application

Compact disc players, Copiers, Game machines, Office automation equipment

●Features

- 1) A plastic lens is used for high sensitivity.
- 2) A built-in visible light filter minimizes the influence of stray light.
- 3) Lightweight and compact.

●External dimensions (Units : mm)

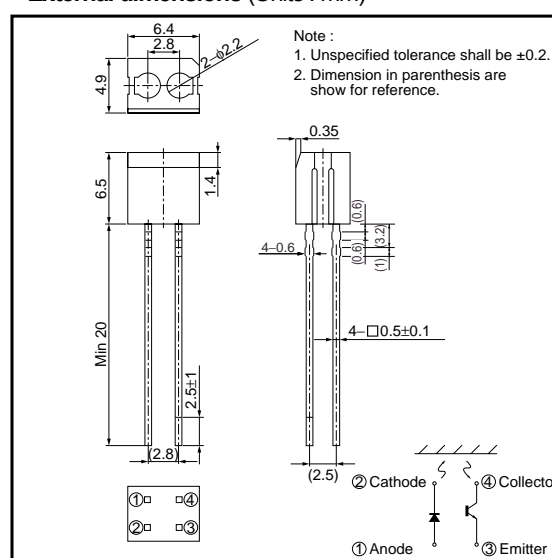

●Absolute maximum ratings (Ta=25°C)

	Parameter	Symbol	Limits	Unit
Input (LED)	Forward current	I_F	50	mA
	Reverse voltage	V_R	5	V
	Power dissipation	P_D	80	mW
Output (Photo-transistor)	Collector-emitter voltage	V_{CEO}	30	V
	Emitter-collector voltage	V_{ECO}	4.5	V
	Collector current	I_C	30	mA
	Collector power dissipation	P_C	80	mW
Operating temperature		T_{opr}	-25~+85	°C
Storage temperature		T_{stg}	-30~+85	°C

Sensors

●Electrical and optical characteristics (Ta=25°C)

Parameter		Symbol	Min.	Typ.	Max.	Unit	Conditions
Input characteristics	Forward voltage	V_F	-	1.34	1.6	V	$I_F=50\text{mA}$
	Reverse current	I_R	-	-	10	μA	$V_R=5\text{V}$
Output characteristics	Dark current	I_{CEO}	-	-	0.5	μA	$V_{CE}=10\text{V}$
	Peak sensitivity wavelength	λ_P	-	800	-	nm	-
Transfer characteristics	Collector current	I_C	0.08	0.3	0.8	μA	$V_{CE}=2\text{V}, I_F=10\text{mA}$
	Collector-emitter saturation voltage	$V_{CE(sat)}$	-	0.1	0.3	V	$I_F=20\text{mA}, I_C=0.1\text{mA}$
	Response time	tr-tf	-	10	-	μs	$V_{CC}=10\text{V}, I_F=20\text{mA}, R_L=100\Omega$

●Electrical and optical characteristic curves

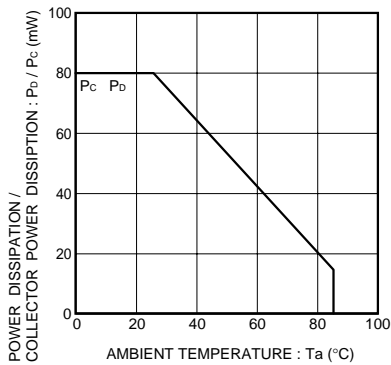

Fig.1 Power dissipation / collector power dissipation vs. ambient temperature

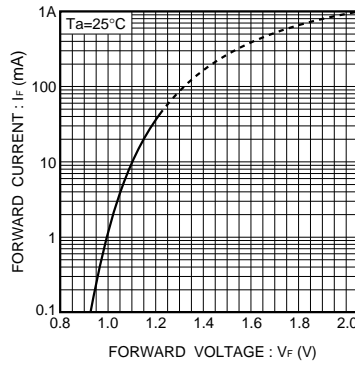

Fig.2 Forward current vs. forward voltage

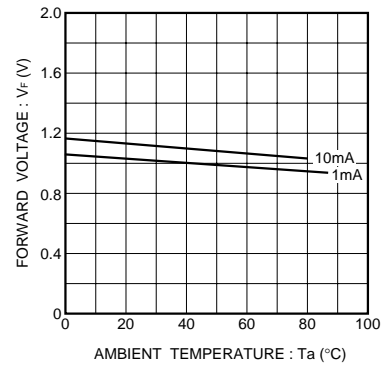

Fig.3 Forward voltage vs. ambient temperature

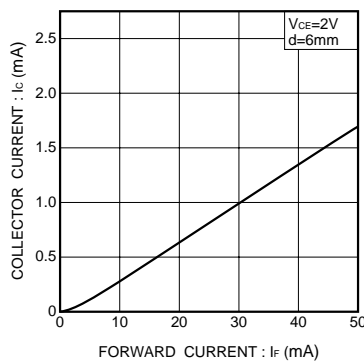

Fig.4 Collector current vs. forward current

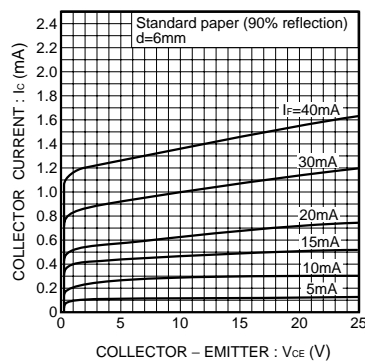

Fig.5 Output characteristics

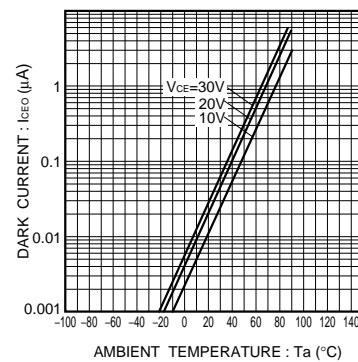

Fig.6 Dark current vs. ambient temperature

Sensors

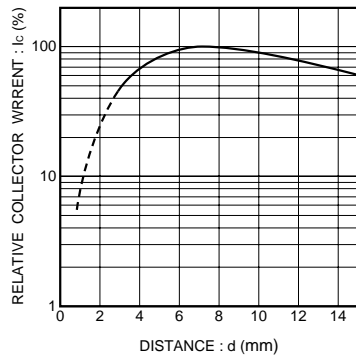

Fig.7 Relative output vs. distance

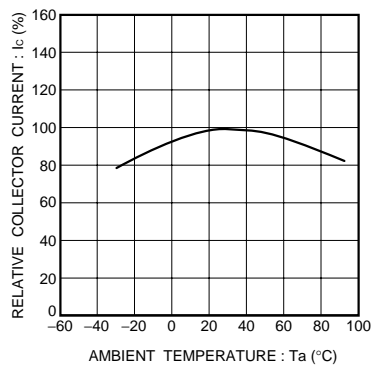

Fig.8 Relative output vs. ambient temperature

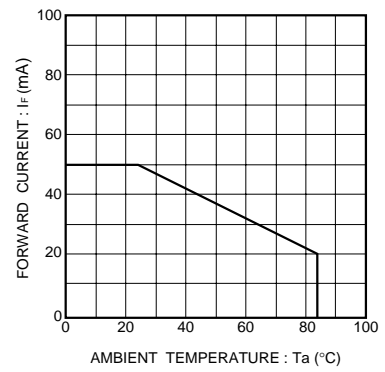

Fig.9 Forward current vs. ambient temperature

●Circuit for testing transfer characteristics

