

CM5441Z161B-00

STEWARD PART NUMBERING SYSTEM					
CM	2545	X	111	B	- 00
PRODUCT SERIES CODE	PART SIZE CODE	RATED CURRENT CODE	IMPEDANCE VALUE CODE	PACKAGING CODE	ADDITIONAL DESCRIPTION

Ambient Operating Temperature Range : -55°C to + 125°C

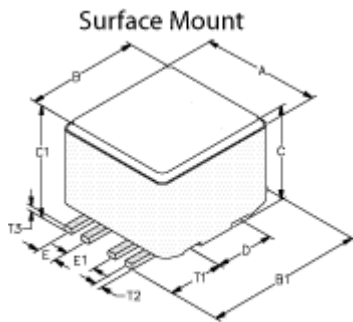
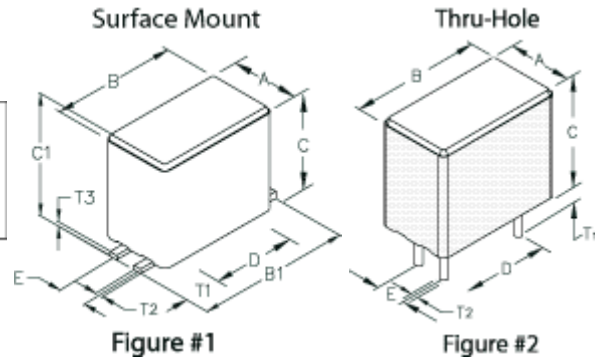

Figure #3

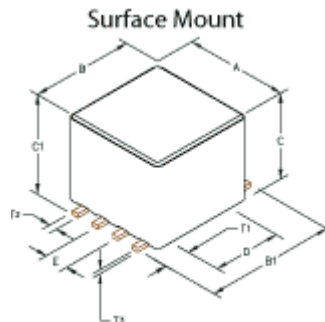

Figure #4

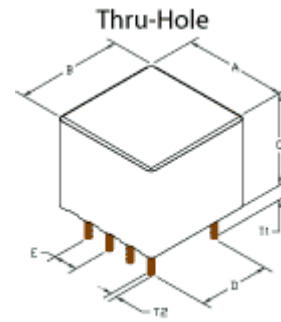

Figure #5

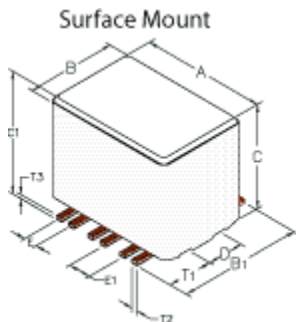

Figure #6

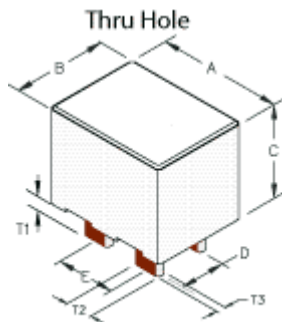

Figure #7

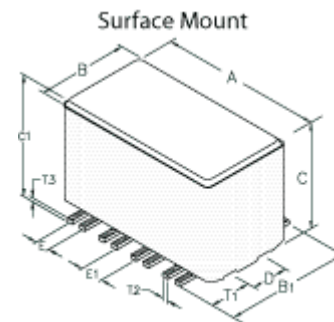

Figure #8

Drawing Figure #

Figure Number
7

Electrical Characteristics

NET Z @ 100 MHz	DCR Max	Rated Current mA
160	0.0003	75000

Physical Dimensions

A	B	B1	C	C1	D	E	E1	A	B	B1	C	C1	D	E	E1
mm	mm	mm	mm	mm	mm	mm	mm	in	in	in	in	in	in	in	in
13.72	10.41	-	15.24	-	5.28	6.35	-	0.540	0.410	-	0.600	-	0.208	0.250	-

Wire Dimensions

--

T1 mm	T2 mm	T3 mm	T1 in	T2 in	T3 in
3.05	3.07	0.97	0.120	0.121	0.038

CM5441Z161B-00

Z vs. Frequency (C,O,N)

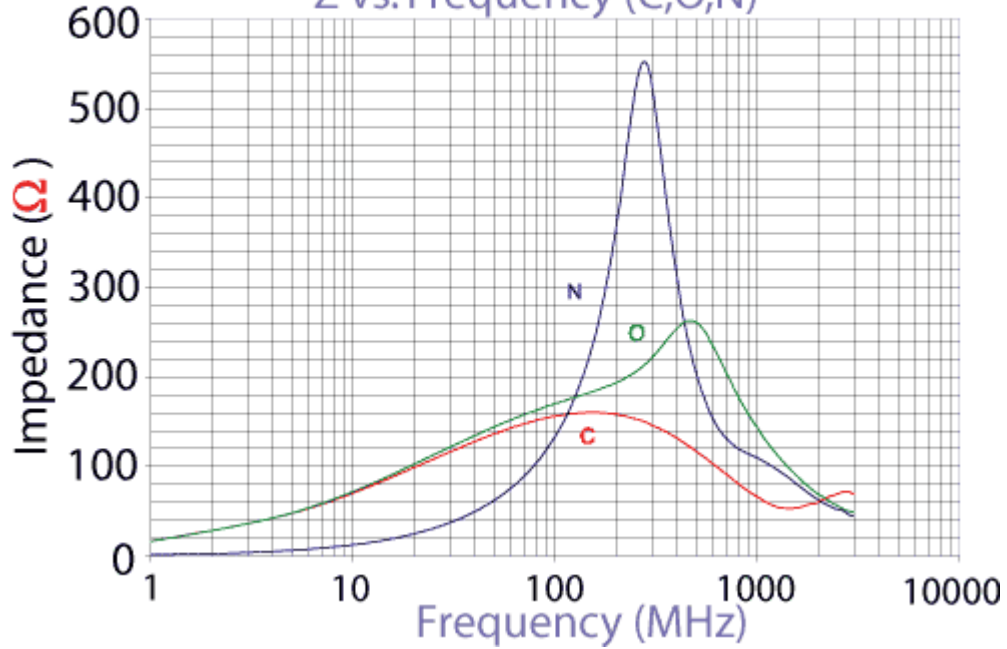

CM5441Z161B-00

Z, R, X_L vs Frequency

