



MULTILAYER CERAMIC CHIP CAPACITORS



C Series Low ESL Flip Type

Type: C0510 [EIA CC0204]
C0816 [EIA CC0306]
C1220 [EIA CC0508]
C1632 [EIA CC0612]

Issue date: April 2011



**TDK MLCC
US Catalog**

Version B11

REMINDERS

Please read before using this product

SAFETY REMINDERS



REMINDERS

1. If you intend to use a product listed in this catalog for a purpose that may cause loss of life or other damage, you must contact our company's sales window.
2. We may modify products or discontinue production of a product listed in this catalog without prior notification.
3. We provide "Delivery Specification" that explain precautions for the specifications and safety of each product listed in this catalog. We strongly recommend that you exchange these delivery specifications with customers that use one of these products.
4. If you plan to export a product listed in this catalog, keep in mind that it may be a restricted item according to the "Foreign Exchange and Foreign Trade Control Law". In such cases, it is necessary to acquire export permission in harmony with this law.
5. Any reproduction or transferring of the contents of this catalog is prohibited without prior permission from our company.
6. We are not responsible for problems that occur related to the intellectual property rights or other rights of our company or a third party when you use a product listed in this catalog. We do not grant license of these rights.
7. This catalog only applies to products purchased through our company or one of our company's official agencies. This catalog does not apply to products that are purchased through other third parties.

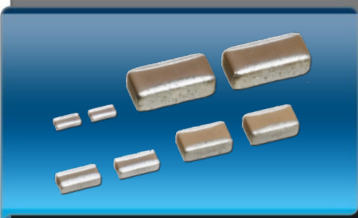

C Series

Low ESL Flip Type

Type: C0510, C0816, C1220, C1632

Features



- Positioning the electrodes along the length of the chip device, reduces ESR and ESL components over conventional products.
- Provides high frequency noise suppression effect because the resonating frequency is high.
- Flipped geometry provides low inductance (less than 400 pH).
- Provides stabilization of power line voltage.
- Suitable for IC decoupling application.

PC Board Pattern

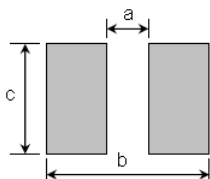

Case Size	a	b	c
C0510	0.2	0.6	1.0
C0816	0.3	1.0	1.6
C1220	0.5	1.6	2.0
C1632	0.75	2.2	3.2

Applications



- Decoupling CPU power line
- Bias line in CPU
- High speed digital IC/decoupling
- PC, cell phones, camcorders, etc.

Shape & Dimensions

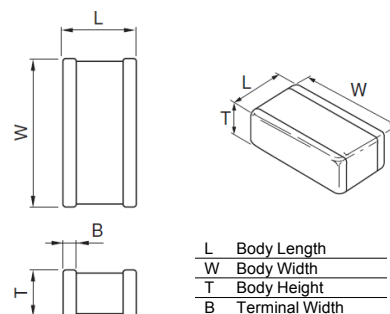

Dimensions in mm

L	Body Length
W	Body Width
T	Body Height
B	Terminal Width

Part Number Construction

Series Name **C** **1632** **X5R** **0J** **106** **M** **T** **XXXX**

Series Name

Dimensions L x W (mm)

Case Code	Length	Width
C0510	0.52 ± 0.05	1.00 ± 0.05
C0816 (C<1μF)	0.80 ± 0.10	1.60 ± 0.10
C0816 (C≥1μF)	0.80 ± 0.15	1.60 ± 0.20
C1220	1.25 ± 0.20	2.00 ± 0.20
C1608	1.60 ± 0.20	3.20 ± 0.20

Temperature Characteristic

Temperature Characteristics	Capacitance Change	Temperature Range
X5R	± 15%	-55 to +85°C
X6S	± 22%	-55 to +105°C
X7R	± 15%	-55 to +125°C
X7S	± 22%	-55 to +125°C

Rated Voltage (DC)

Voltage Code	Voltage (DC)
0G	4V
0J	6.3V
1A	10V
1C	16V
1E	25V
1H	50V

Internal Codes

Packaging Style

Packaging Code	Style
T	Tape & Reel

Capacitance Tolerance

Tolerance Code	Tolerance
K	±15%
M	±20%

Nominal Capacitance (pF)

The capacitance is expressed in three digit codes and in units of pico Farads (pF). The first and second digits identify the first and second significant figures of the capacitance. The third digit identifies the multiplier. R designates a decimal point.

Capacitance Code	Capacitance
0R5	0.5pF
010	1pF
102	1,000pF (1nF)
105	1,000,000pF (1μF)



Capacitance Range Chart

C0510 [EIA CC0204]

Capacitance Range Chart

Temperature Characteristics: X6S ($\pm 22\%$)
 Rated Voltage: 4V (0G)

Capacitance (pF)	Cap Code	Tolerance	X6S
			0G (4V)
10,000	103	M: $\pm 20\%$	
22,000	223		
47,000	473		
100,000	104		
220,000	224		
470,000	474		
1,000,000	105		
2,200,000	225		

Standard Thickness
 0.30 mm



Capacitance Range Table

C0510 [EIA CC0204]

Class 2 (Temperature Stable)

Temperature Characteristics X6S (-55 to +105°C, $\pm 22\%$)

TDK Part Number (Ordering Code)	Temperature Characteristics	Rated Voltage	Capacitance (pF)	Capacitance Tolerance	Thickness (mm)
C0510X6S0G104M	X6S	4V	100,000	$\pm 20\%$	0.30 \pm 0.05
C0510X6S0G224M	X6S	4V	220,000	$\pm 20\%$	0.30 \pm 0.05
C0510X6S0G474M	X6S	4V	470,000	$\pm 20\%$	0.30 \pm 0.05



Capacitance Range Chart

C0816 [EIA CC0306]

Capacitance Range Chart

Temperature Characteristics: X7R, ($\pm 15\%$), X7S ($\pm 22\%$), X5R ($\pm 15\%$), X6S ($\pm 22\%$)
 Rated Voltage: 16V (1C), 10V (1A), 6.3V (0J), 4V (0G)

Capacitance (pF)	Cap Code	Tolerance	X7R		X7S	X5R		X6S
			1C (16V)	0J (6.3V)	0G (4V)	1A (10V)	0J (6.3V)	0G (4V)
10,000	103	K: $\pm 10\%$	█					
22,000	223		M: $\pm 20\%$	█				
47,000	473							
100,000	104					█		
220,000	224			█				
470,000	474				█			
1,000,000	105				█	█	█	
2,200,000	225					█		

Standard Thickness
 0.50 mm



Capacitance Range Table

C0816 [EIA CC0306]

Class 2 (Temperature Stable)

Temperature Characteristics X7R (-55 to +125°C, $\pm 15\%$), X7S (-55 to +125°C, $\pm 2\%$), X5R (-55 to +85°C, $\pm 15\%$)

TDK Part Number (Ordering Code)	Temperature Characteristics	Rated Voltage	Capacitance (pF)	Capacitance Tolerance	Thickness (mm)
C0816X7R1C103K	X7R	16V	10,000	$\pm 10\%$	0.50 \pm 0.10
C0816X7R1C223K	X7R	16V	22,000	$\pm 10\%$	0.50 \pm 0.10
C0816X7R1C473K	X7R	16V	47,000	$\pm 10\%$	0.50 \pm 0.10
C0816X7R1C104K	X7R	16V	100,000	$\pm 10\%$	0.50 \pm 0.10
C0816X7R0J224K	X7R	6.3V	220,000	$\pm 10\%$	0.50 \pm 0.10
C0816X7S0G474K	X7S	4V	470,000	$\pm 10\%$	0.50 \pm 0.10
C0816X7S0G105M	X7S	4V	1,000,000	$\pm 20\%$	0.50 \pm 0.10
C0816X7S0G225M	X7S	4V	2,200,000	$\pm 20\%$	0.50 \pm 0.10
C0816X5R1A224K	X5R	10V	220,000	$\pm 10\%$	0.50 \pm 0.10
C0816X5R1A474K	X5R	10V	470,000	$\pm 10\%$	0.50 \pm 0.10
C0816X5R0J474K	X5R	6.3V	470,000	$\pm 10\%$	0.50 \pm 0.10
C0816X5R0J105M	X5R	6.3V	1,000,000	$\pm 20\%$	0.50 \pm 0.10
C0816X5R0J225M	X5R	6.3V	2,200,000	$\pm 20\%$	0.50 \pm 0.10



Capacitance Range Chart

C1220 [EIA CC0508]

Capacitance Range Chart

Temperature Characteristics: X7R, ($\pm 15\%$), X5R ($\pm 15\%$)
 Rated Voltage: 50V (1H), 25V (1E), 16V (1C), 10V (1A), 6.3V (0J)

Capacitance (pF)	Cap Code	Tolerance	X7R				X5R
			1H (50V)	1E (25V)	1C (16V)	0J (6.3V)	1A (10V)
10,000	103	K: $\pm 10\%$ M: $\pm 20\%$					
22,000	223						
47,000	473						
100,000	104						
220,000	224						
470,000	474						
1,000,000	105						

Standard Thickness
 0.85 mm



Capacitance Range Table

C1220 [EIA CC0508]

Class 2 (Temperature Stable)

Temperature Characteristics X7R (-55 to +125°C, $\pm 15\%$), X5R (-55 to +85°C, $\pm 15\%$)

TDK Part Number (Ordering Code)	Temperature Characteristics	Rated Voltage	Capacitance (pF)	Capacitance Tolerance	Thickness (mm)
C1220X7R1H103K	X7R	50V	10,000	$\pm 10\%$	0.85 \pm 0.10
C1220X7R1H223K	X7R	50V	22,000	$\pm 10\%$	0.85 \pm 0.10
C1220X7R1H473K	X7R	50V	47,000	$\pm 10\%$	0.85 \pm 0.10
C1220X7R1E104K	X7R	25V	100,000	$\pm 10\%$	0.85 \pm 0.10
C1220X7R1C224K	X7R	16V	220,000	$\pm 10\%$	0.85 \pm 0.10
C1220X7R0J474K	X7R	6.3V	470,000	$\pm 10\%$	0.85 \pm 0.10
C1220X7R0J105M	X7R	6.3V	1,000,000	$\pm 20\%$	0.85 \pm 0.10
C1220X5R1A474K	X5R	10V	470,000	$\pm 10\%$	0.85 \pm 0.10
C1220X5R1A105M	X5R	10V	1,000,000	$\pm 20\%$	0.85 \pm 0.10



Capacitance Range Chart

C1632 [EIA CC0612]

Capacitance Range Chart

Temperature Characteristics: X7R, ($\pm 15\%$), X7S ($\pm 22\%$), X5R ($\pm 15\%$)
 Rated Voltage: 50V (1H), 25V (1E), 16V (1C), 10V (1A), 6.3 (0J), 4V (0G)

Capacitance (pF)	Cap Code	Tolerance	X7R				X7S	X5R	
			1H (50V)	1E (25V)	1C (16V)	0J (6.3V)	0G (4V)	1A (10V)	0J (6.3V)
10,000	103	K: $\pm 10\%$ M: $\pm 20\%$	█						
22,000	223								
47,000	473								
100,000	104								
220,000	224		█						
470,000	474			█					
1,000,000	105				█				
2,200,000	225					█			
4,700,000	475						█		
10,000,000	106							█	

Standard Thickness



0.70 mm



1.15 mm



1.30 mm



Capacitance Range Table

C1632 [EIA CC0612]

Class 2 (Temperature Stable)

Temperature Characteristics X7R (-55 to +125°C, ±15%), X7S (-55 to +125°C, ±2%), X5R (-55 to +85°C, ±15%)

TDK Part Number (Ordering Code)	Temperature Characteristics	Rated Voltage	Capacitance (pF)	Capacitance Tolerance	Thickness (mm)
C1632X7R1H103K	X7R	50V	10,000	± 10%	0.70 ± 0.10
C1632X7R1H223K	X7R	50V	22,000	± 10%	0.70 ± 0.10
C1632X7R1H473K	X7R	50V	47,000	± 10%	0.70 ± 0.10
C1632X7R1H104K	X7R	50V	100,000	± 10%	0.70 ± 0.10
C1632X7R1H224K	X7R	50V	220,000	± 10%	1.15 ± 0.10
C1632X7R1E224K	X7R	25V	220,000	± 10%	0.70 ± 0.10
C1632X7R1E474K	X7R	25V	470,000	± 10%	1.15 ± 0.10
C1632X7R1C474K	X7R	16V	470,000	± 10%	0.70 ± 0.10
C1632X7R1C105K	X7R	16V	1,000,000	± 10%	1.15 ± 0.10
C1632X7R0J105M	X7R	6.3V	1,000,000	± 20%	0.70 ± 0.10
C1632X7R0J225M	X7R	6.3V	2,200,000	± 20%	1.15 ± 0.10
C1632X7S0G475M	X7S	4V	4,700,000	± 20%	1.30 ± 0.10
C1632X7S0G106M	X7S	4V	10,000,000	± 20%	1.30 ± 0.10
C1632X5R1A105M	X5R	10V	1,000,000	± 20%	0.70 ± 0.10
C1632X5R1A225M	X5R	10V	2,200,000	± 20%	1.15 ± 0.10
C1632X5R0J475M	X5R	6.3V	4,700,000	± 20%	1.30 ± 0.10
C1632X5R0J106M	X5R	6.3V	10,000,000	± 20%	1.30 ± 0.10



General Specifications

C Series – Low ESL Flip Type

No.	Item	Performance	Test or Inspection Method												
1	External Appearance	No defects which may affect performance.	Inspect with magnifying glass (3×).												
2	Insulation Resistance	10,000MΩ or 500MΩ•μF min. (whichever smaller). As for the capacitor of rated voltage 16, 10, 6.3 and 4V DC, 100MΩ•μF min.	Apply rated voltage for 60s.												
3	Voltage Proof	Withstand test voltage without insulation breakdown or other damage.	Apply 2.5 x rated voltage for 1 ~ 5s. Charge / discharge current shall not exceed 50mA.												
4	Capacitance	Within the specified tolerance.	<table border="1"> <thead> <tr> <th>Measuring Frequency</th> <th>Rated Voltage</th> <th>Measuring Voltage</th> </tr> </thead> <tbody> <tr> <td rowspan="2">1kHz±10%</td> <td>50V ~ 6.3V</td> <td>1.0±0.2 V_{rms}</td> </tr> <tr> <td>4V</td> <td>0.5 - 5 V_{rms}</td> </tr> </tbody> </table>	Measuring Frequency	Rated Voltage	Measuring Voltage	1kHz±10%	50V ~ 6.3V	1.0±0.2 V _{rms}	4V	0.5 - 5 V _{rms}				
			Measuring Frequency	Rated Voltage	Measuring Voltage										
1kHz±10%	50V ~ 6.3V	1.0±0.2 V _{rms}													
	4V	0.5 - 5 V _{rms}													
5	Dissipation Factor (Class 2)	<table border="1"> <thead> <tr> <th>T.C.</th> <th>Rated Voltage</th> <th>D.F.</th> </tr> </thead> <tbody> <tr> <td>X7R</td> <td>50V, 25V DC</td> <td>0.03 max.</td> </tr> <tr> <td>X7R X5R</td> <td>16V, 10V, 6.3V DC</td> <td>0.05 max.</td> </tr> <tr> <td>X7S X6S X5S</td> <td>4V DC</td> <td>0.12 max.</td> </tr> </tbody> </table>	T.C.	Rated Voltage	D.F.	X7R	50V, 25V DC	0.03 max.	X7R X5R	16V, 10V, 6.3V DC	0.05 max.	X7S X6S X5S	4V DC	0.12 max.	See No.4 in this table for measuring condition.
T.C.	Rated Voltage	D.F.													
X7R	50V, 25V DC	0.03 max.													
X7R X5R	16V, 10V, 6.3V DC	0.05 max.													
X7S X6S X5S	4V DC	0.12 max.													
6	Temperature Characteristics of Capacitance (Class 2)	Capacitance Change (%)	Capacitance shall be measured by the steps shown in the following table after thermal equilibrium is obtained for each step. ΔC be calculated ref. STEP3 reading <table border="1"> <thead> <tr> <th>Step</th> <th>Temperature (°C)</th> </tr> </thead> <tbody> <tr> <td>1</td> <td>Reference temp. ± 2</td> </tr> <tr> <td>2</td> <td>Min. operating temp. ± 2</td> </tr> <tr> <td>3</td> <td>Reference temp. ± 2</td> </tr> <tr> <td>4</td> <td>Max. operating temp. ± 2</td> </tr> </tbody> </table>	Step	Temperature (°C)	1	Reference temp. ± 2	2	Min. operating temp. ± 2	3	Reference temp. ± 2	4	Max. operating temp. ± 2		
		Step		Temperature (°C)											
1	Reference temp. ± 2														
2	Min. operating temp. ± 2														
3	Reference temp. ± 2														
4	Max. operating temp. ± 2														
<table border="1"> <thead> <tr> <th colspan="2">No Voltage Applied</th> </tr> <tr> <th>T.C.</th> <th>Δ C Percent</th> </tr> </thead> <tbody> <tr> <td>X5R X7R</td> <td>± 15%</td> </tr> <tr> <td>X5S X6S X7S</td> <td>± 22%</td> </tr> </tbody> </table>	No Voltage Applied		T.C.	Δ C Percent	X5R X7R	± 15%	X5S X6S X7S	± 22%							
No Voltage Applied															
T.C.	Δ C Percent														
X5R X7R	± 15%														
X5S X6S X7S	± 22%														
7	Robustness of Terminations	No sign of termination coming off, breakage of ceramic, or other abnormal signs.	Reflow solder the capacitor on P.C. board (shown in Appendix 1) and apply a pushing force of 5N (C0510: 2N) for 10 ± 1s. <div style="text-align: right;"> </div>												

No.	Item	Performance	Test or Inspection Method									
8	Bending	No mechanical damage.	Reflow solder the capacitor on P.C. board (shown in Appendix 2) and bend it for 1mm. 									
9	Solderability	New solder to cover over 75% of termination. 25% may have pinholes or rough spots but not concentrated in one spot. Ceramic surface of "A sections" shall not be exposed due to melting or shifting of termination material. 	Completely soak both terminations in solder at $235 \pm 5^\circ\text{C}$ for $2 \pm 0.5\text{s}$. Solder: H63A (JIS Z 3282) Flux: Isopropyl alcohol (JIS K 8839) Rosin (JIS K 5902) 25% solid solution.									
10	Resistance to solder heat	External appearance: No cracks are allowed and terminations shall be covered at least 60% with new solder. Capacitance: <table border="1" style="margin-left: 20px;"> <thead> <tr> <th>Characteristics</th> <th>Change from the value before test</th> </tr> </thead> <tbody> <tr> <td>Class 2</td> <td> <table border="1" style="margin-left: 20px;"> <tr> <td>X7R</td> <td rowspan="4">± 7.5 %</td> </tr> <tr> <td>X7S</td> </tr> <tr> <td>X5R</td> </tr> <tr> <td>X6S</td> </tr> </table> </td> </tr> </tbody> </table>	Characteristics	Change from the value before test	Class 2	<table border="1" style="margin-left: 20px;"> <tr> <td>X7R</td> <td rowspan="4">± 7.5 %</td> </tr> <tr> <td>X7S</td> </tr> <tr> <td>X5R</td> </tr> <tr> <td>X6S</td> </tr> </table>	X7R	± 7.5 %	X7S	X5R	X6S	Completely soak both terminations in solder at $260 \pm 5^\circ\text{C}$ for $5 \pm 1\text{s}$. Preheating condition Temp. : $150 \pm 10^\circ\text{C}$ Time: 1 ~ 2min. Flux: Isopropyl alcohol (JIS K 8839) Rosin (JIS K 5902) 25% solid solution. Solder : H63A (JIS Z 3282)
Characteristics	Change from the value before test											
Class 2	<table border="1" style="margin-left: 20px;"> <tr> <td>X7R</td> <td rowspan="4">± 7.5 %</td> </tr> <tr> <td>X7S</td> </tr> <tr> <td>X5R</td> </tr> <tr> <td>X6S</td> </tr> </table>	X7R	± 7.5 %	X7S	X5R	X6S						
X7R	± 7.5 %											
X7S												
X5R												
X6S												
	D.F. (Class 2)	Meet the initial spec.	Leave the capacitor in ambient conditions for $24 \pm 2\text{h}$ before measurement.									
	Insulation Resistance	Meet the initial spec.										
	Voltage proof	No insulation breakdown or other damage.										



No.	Item	Performance	Test or Inspection Method																								
11	Vibration																										
	External appearance	No mechanical damage.	Solder the capacitors on P.C. board (shown in Appendix 1) before testing. Vibrate the capacitor with amplitude of 1.5mm P-P changing the frequencies from 10Hz to 55Hz and back to 10Hz in about 1min. Repeat this for 2h each in 3 perpendicular directions.																								
	Capacitance	<table border="1"> <thead> <tr> <th>Characteristics</th> <th>Change from the value before test</th> </tr> </thead> <tbody> <tr> <td>Class 2</td> <td> <table border="1"> <tr> <td>X7R</td> <td rowspan="4">± 7.5 %</td> </tr> <tr> <td>X7S</td> </tr> <tr> <td>X5R</td> </tr> <tr> <td>X6S</td> </tr> </table> </td> </tr> </tbody> </table>	Characteristics	Change from the value before test	Class 2	<table border="1"> <tr> <td>X7R</td> <td rowspan="4">± 7.5 %</td> </tr> <tr> <td>X7S</td> </tr> <tr> <td>X5R</td> </tr> <tr> <td>X6S</td> </tr> </table>	X7R	± 7.5 %	X7S	X5R	X6S																
Characteristics	Change from the value before test																										
Class 2	<table border="1"> <tr> <td>X7R</td> <td rowspan="4">± 7.5 %</td> </tr> <tr> <td>X7S</td> </tr> <tr> <td>X5R</td> </tr> <tr> <td>X6S</td> </tr> </table>	X7R	± 7.5 %	X7S	X5R	X6S																					
X7R	± 7.5 %																										
X7S																											
X5R																											
X6S																											
D.F. (Class 2)	Meet the initial spec.																										
12	Temperature cycle																										
	External appearance	No mechanical damage.	Solder the capacitors on P.C. board (shown in Appendix 1) before testing. Expose the capacitor in the conditions step1 through 4 and repeat 5 times consecutively. Leave the capacitor in ambient conditions for 24 ± 2h before measurement.																								
	Capacitance	<table border="1"> <thead> <tr> <th>Characteristics</th> <th>Change from the value before test</th> </tr> </thead> <tbody> <tr> <td>Class 2</td> <td> <table border="1"> <tr> <td>X7R</td> <td rowspan="4">± 7.5 %</td> </tr> <tr> <td>X7S</td> </tr> <tr> <td>X5R</td> </tr> <tr> <td>X6S</td> </tr> </table> </td> </tr> </tbody> </table>	Characteristics	Change from the value before test	Class 2	<table border="1"> <tr> <td>X7R</td> <td rowspan="4">± 7.5 %</td> </tr> <tr> <td>X7S</td> </tr> <tr> <td>X5R</td> </tr> <tr> <td>X6S</td> </tr> </table>	X7R	± 7.5 %	X7S	X5R	X6S	<table border="1"> <thead> <tr> <th>Step</th> <th>Temperature (°C)</th> <th>Time (min.)</th> </tr> </thead> <tbody> <tr> <td>1</td> <td>Min. operating temp. ±3</td> <td>30 ± 3</td> </tr> <tr> <td>2</td> <td>Reference Temp.</td> <td>2 – 5</td> </tr> <tr> <td>3</td> <td>Max. operating temp. ± 2</td> <td>30 ± 2</td> </tr> <tr> <td>4</td> <td>Reference Temp.</td> <td>2 - 5</td> </tr> </tbody> </table>	Step	Temperature (°C)	Time (min.)	1	Min. operating temp. ±3	30 ± 3	2	Reference Temp.	2 – 5	3	Max. operating temp. ± 2	30 ± 2	4	Reference Temp.	2 - 5
	Characteristics	Change from the value before test																									
Class 2	<table border="1"> <tr> <td>X7R</td> <td rowspan="4">± 7.5 %</td> </tr> <tr> <td>X7S</td> </tr> <tr> <td>X5R</td> </tr> <tr> <td>X6S</td> </tr> </table>	X7R	± 7.5 %	X7S	X5R	X6S																					
X7R	± 7.5 %																										
X7S																											
X5R																											
X6S																											
Step	Temperature (°C)	Time (min.)																									
1	Min. operating temp. ±3	30 ± 3																									
2	Reference Temp.	2 – 5																									
3	Max. operating temp. ± 2	30 ± 2																									
4	Reference Temp.	2 - 5																									
D.F. (Class 2)	Meet the initial spec.																										
Insulation Resistance	1,000MΩ or 50MΩ·μF min. whichever smaller.																										
Voltage Proof	No insulation breakdown or other damage.																										
13	Moisture Resistance (Steady State)																										
	External appearance	No mechanical damage.	Solder the capacitor on P.C. board (shown in Appendix 1) before testing. Leave at temperature 40 ± 2°C, 90 to 95%RH for 500 +24, 0h. Leave the capacitor in ambient conditions for 24 ± 2h before measurement.																								
	Capacitance	<table border="1"> <thead> <tr> <th>Characteristics</th> <th>Change from the value before test</th> </tr> </thead> <tbody> <tr> <td>Class 2</td> <td> <table border="1"> <tr> <td>X7R</td> <td rowspan="4">± 12.5 %</td> </tr> <tr> <td>X7S</td> </tr> <tr> <td>X5R</td> </tr> <tr> <td>X6S</td> </tr> </table> </td> </tr> </tbody> </table>	Characteristics	Change from the value before test	Class 2	<table border="1"> <tr> <td>X7R</td> <td rowspan="4">± 12.5 %</td> </tr> <tr> <td>X7S</td> </tr> <tr> <td>X5R</td> </tr> <tr> <td>X6S</td> </tr> </table>	X7R	± 12.5 %	X7S	X5R	X6S																
Characteristics	Change from the value before test																										
Class 2	<table border="1"> <tr> <td>X7R</td> <td rowspan="4">± 12.5 %</td> </tr> <tr> <td>X7S</td> </tr> <tr> <td>X5R</td> </tr> <tr> <td>X6S</td> </tr> </table>	X7R	± 12.5 %	X7S	X5R	X6S																					
X7R	± 12.5 %																										
X7S																											
X5R																											
X6S																											
D.F. (Class 2)	Characteristics X7R: 200% of initial spec. max. X7S: 200% of initial spec. max. X5R: 200% of initial spec. max. X6S: 200% of initial spec. max.																										
Insulation Resistance	1,000MΩ or 50MΩ·μF min. (whichever smaller). As for the capacitor of rated voltage 16, 10, 6.3 and 4V DC, 10MΩ·μF min.																										



No.	Item	Performance	Test or Inspection Method									
14	Moisture Resistance											
	External appearance	No mechanical damage.	Solder the capacitors on P.C. board (shown in Appendix 1) before testing. Apply the rated voltage at temperature $40 \pm 2^\circ\text{C}$ and 90 to 95%RH for 500 +24, 0h. Charge/discharge current shall not exceed 50mA.									
	Capacitance	<table border="1"> <thead> <tr> <th>Characteristics</th> <th>Change from the value before test</th> </tr> </thead> <tbody> <tr> <td rowspan="4">Class 2</td> <td>X7R</td> <td rowspan="4">$\pm 12.5 \%$</td> </tr> <tr> <td>X7S</td> </tr> <tr> <td>X5R</td> </tr> <tr> <td>X6S</td> </tr> </tbody> </table>		Characteristics	Change from the value before test	Class 2	X7R	$\pm 12.5 \%$	X7S	X5R	X6S	Leave the capacitor in ambient conditions for $48 \pm 4\text{h}$ before measurement. Voltage conditioning: Voltage treats the capacitor under testing temperature and voltage for 1hour.
		Characteristics	Change from the value before test									
	Class 2	X7R	$\pm 12.5 \%$									
X7S												
X5R												
X6S												
D.F. (Class 2)	Characteristics X7R: 200% of initial spec. max. X7S: 200% of initial spec. max. X5R: 200% of initial spec. max. X6S: 200% of initial spec. max.	Leave the capacitor in ambient conditions for $24 \pm 2\text{h}$ before measurement. Use this measurement for initial value.										
Insulation Resistance	500M Ω or 25M Ω • μF min. (whichever smaller). As for the capacitor of rated voltage 16, 10, 6.3 and 4V DC, 5M Ω • μF min.											
15	Life											
	External appearance	No mechanical damage.	Reflow Solder the capacitor on P.C. board (shown in Appendix 1) before testing. Apply rated voltage at maximum operating temperature $\pm 2^\circ\text{C}$ for 1,000 +48, 0h. Charge/discharge current shall not exceed 50mA.									
	Capacitance	<table border="1"> <thead> <tr> <th>Characteristics</th> <th>Change from the value before test</th> </tr> </thead> <tbody> <tr> <td rowspan="4">Class 2</td> <td>X7R</td> <td rowspan="4">$\pm 15 \%$</td> </tr> <tr> <td>X7S</td> </tr> <tr> <td>X5R</td> </tr> <tr> <td>X6S</td> </tr> </tbody> </table>		Characteristics	Change from the value before test	Class 2	X7R	$\pm 15 \%$	X7S	X5R	X6S	Leave the capacitor in ambient conditions for $24 \pm 2\text{h}$ before measurement. Voltage conditioning: Voltage treats the capacitor under testing temperature and voltage for 1hour.
		Characteristics	Change from the value before test									
	Class 2	X7R	$\pm 15 \%$									
X7S												
X5R												
X6S												
D.F. (Class 2)	Characteristics X7R: 200% of initial spec. max. X7S: 200% of initial spec. max. X5R: 200% of initial spec. max. X6S: 200% of initial spec. max.	Leave the capacitor in ambient conditions for $48 \pm 4\text{h}$ before measurement. Use this measurement for initial value.										
Insulation Resistance	1,000M Ω or 50M Ω • μF min. whichever smaller. As for the capacitor of rated voltage 16, 10, 6.3 and 4V DC, 10M Ω • μF min.											

*As for the initial measurement of capacitors on number 6, 10, 11, 12 and 13, leave capacitor at 150 -10, 0°C for 1h and measure the value after leaving capacitor for $24 \pm 2\text{h}$ in ambient condition.



Appendix - 1

P.C. Board for reliability test

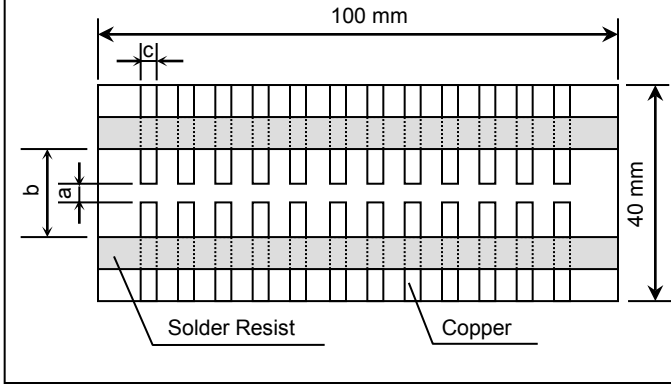

Appendix - 2

P.C. Board for bending test

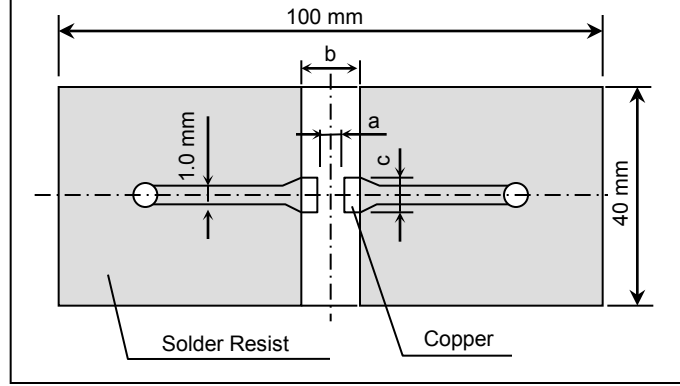

Material : Glass Epoxy (As per JIS C6484 GE4)

P.C. Board thickness : Appendix 1,2 1.6mm

- Copper (thickness 0.035mm)
- Solder resist

Case Code		Dimensions (mm)		
JIS	EIA	a	b	c
C0510	CC0204	0.2	0.6	1.0
C0816	CC0306	0.3	1.0	1.6
C1220	CC0508	0.5	1.6	2.0
C1632	CC0612	0.75	2.2	3.2

Soldering Information

C Series – Low ESL Flip Type

Recommended Soldering Land Pattern

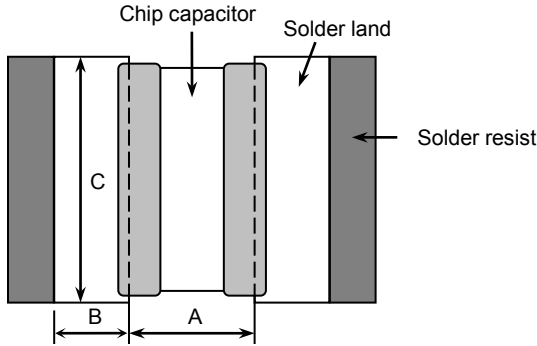

Recommended Soldering Profile

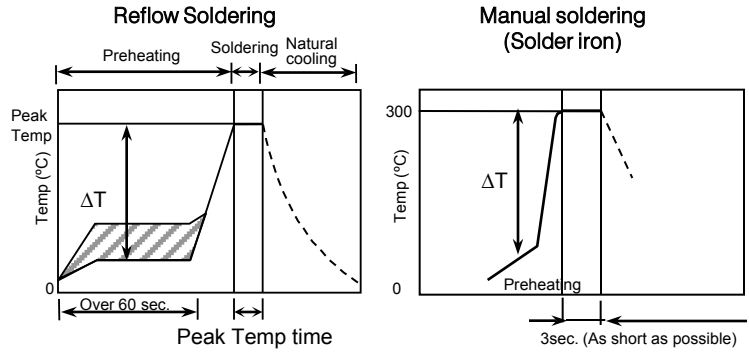

Reflow Soldering

Unit: mm

Type	C0510 [CC0204]	C0816 [CC0306]	C1220 [CC0508]	C1632 [CC0612]
A	0.20	0.30	0.50	0.75
B	0.20	0.35	0.55	0.725
C	1.00	1.60	2.00	3.20

Recommended soldering duration

Solder	Temp./ Dura.	Reflow Soldering	
		Peak temp (°C)	Duration (sec.)
Sn-Pb Solder		230 max.	20 max.
Lead-Free Solder		260 max.	10 max.

Recommended solder compositions

Sn-37Pb (Sn-Pb solder)

Sn-3.0Ag-0.5Cu (Lead Free Solder)

Preheating Condition

Soldering	Temp. (°C)
Reflow soldering	$\Delta T \leq 150$
Manual soldering	$\Delta T \leq 150$

Recommended Solder Amount

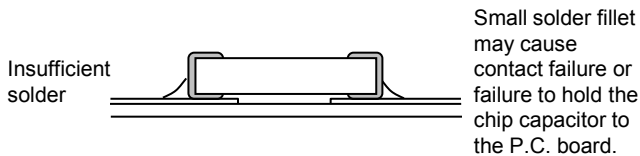
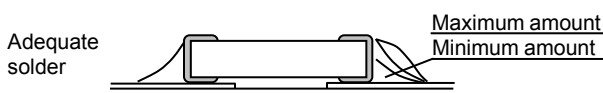
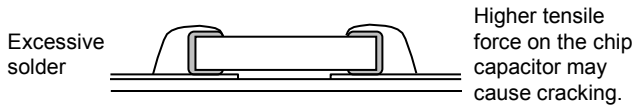



Packaging Information

C Series – Low ESL Flip Type

Carrier Tape Configuration

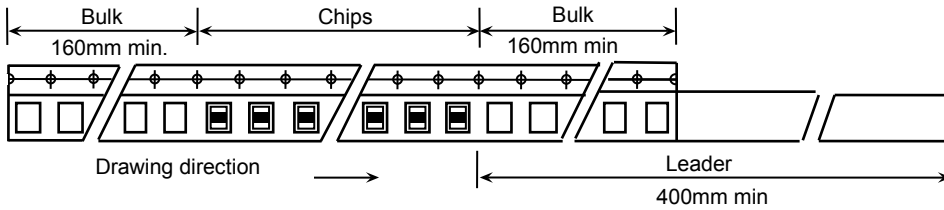

Peel Back Force (Top Tape)

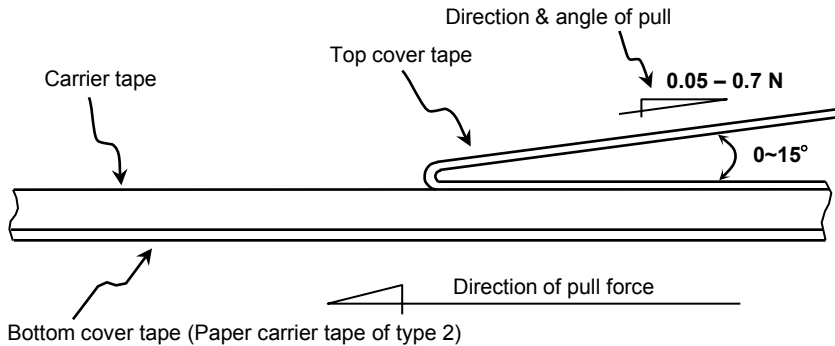

- Carrier tape shall be flexible enough to be wound around a minimum radius of 30mm with components in tape.
- The missing of components shall be less than 0.1%
- Components shall not stick to the cover tape.
- The cover tape shall not protrude beyond the edges of the carrier tape not shall cover the sprocket holes.

Chip Quantity Per Reel and Structure of Reel (Paper & Plastic)

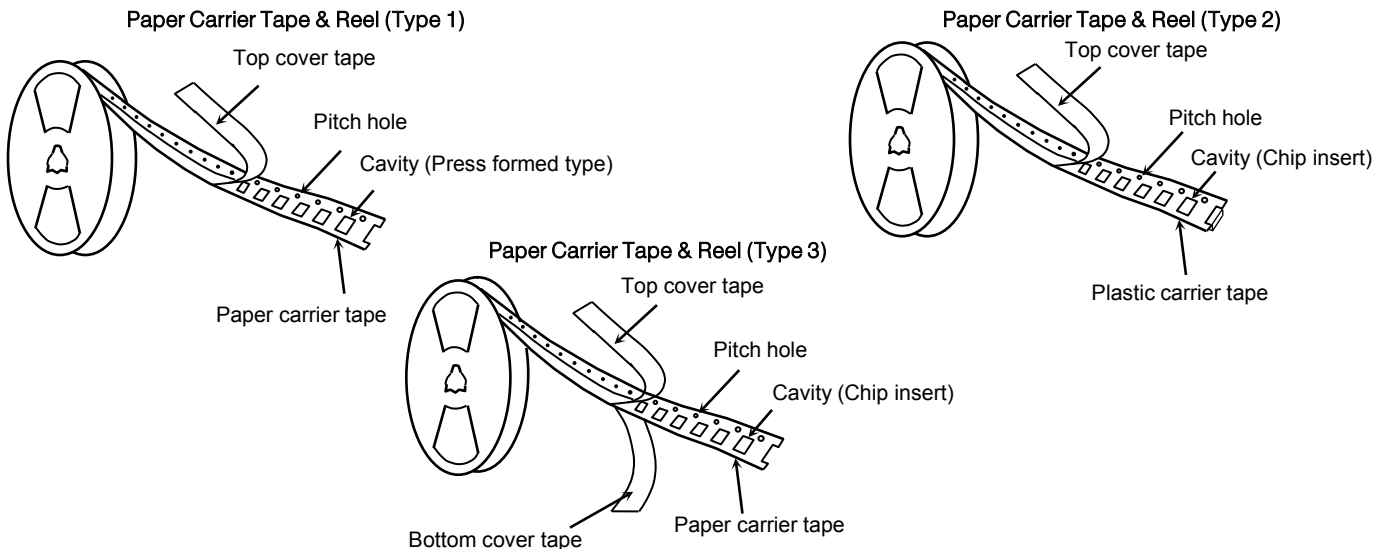

Case Code		Chip Thickness	Taping Material	Chip quantity (pcs.)	
JIS	EIA			φ178mm (7") reel	φ330mm (13") reel
C0510	CC0204	0.50 mm	Paper (Type 1)	15,000	50,000
C0816	CC0306	0.80 mm	Plastic (Type 3)	4,000	10,000
C1220	CC0508	0.85 mm	Paper (Type 2)	4,000	10,000
C1632	CC0612	0.70 mm	Plastic (Type 3)	4,000	10,000
		1.15 mm		2,000	
		1.30 mm			



Additional Information

C Series – Low ESL Flip Type

• Shape & Dimensions

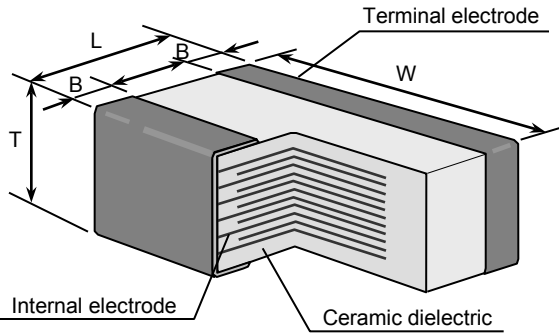

Case Code		Dimensions (mm)				
JIS	EIA	L	W	T	B	G
C0510	CC0204	0.52	1.00	0.50	0.10 min.	0.09 min.
C0816	CC0306	0.80	1.60	0.80	0.10 min.	-
C1220	CC0508	1.25	2.00	0.85	0.20 min.	0.40 min.
C1632	CC0612	1.60	3.20	0.70	0.20 min.	0.50 min.
				1.15		
				1.30		

• Inside Structure & Material System

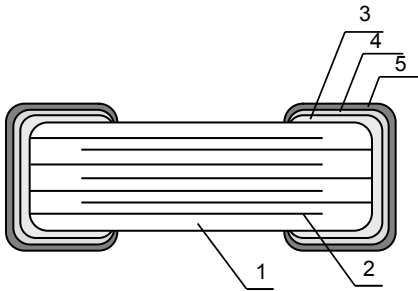

No.	NAME	MATERIAL
		Class 2
(1)	Ceramic Dielectric	BaTiO ₃
(2)	Internal Electrode	Nickel (Ni)
(3)	Termination	Copper (Cu)
(4)		Nickel (Ni)
(5)		Tin (Sn)

• Environmental Information

TDK Corporation established internal product environmental assurance standards that include the six hazardous substances banned by the EU RoHS Directive¹ enforced on July 1, 2006 along with additional substances independently banned by TDK and has successfully completed making general purpose electronic components conform to the RoHS Directive².

1. Abbreviation for Restriction on Hazardous Substances, which refers to the regulation EU Directive 2002/95/EC on hazardous substances by the European Union (EU) effective from July 1, 2006. The Directive bans the use of six specific hazardous substances in electric and electronic devices and products handled within the EU. The six substances are lead, mercury, cadmium, hexavalent chromium, PBB (polybrominated biphenyls), and PBDE (polybrominated diphenyl ethers).
2. This means that, in conformity with the EU Directive 2002/95/EC, lead, cadmium, mercury, hexavalent chromium, and specific bromine-based flame retardants, PBB and PBDE, have not been used, except for exempted applications.

For REACH (SVHC : 15 substances according to ECHA / October 2008) : All TDK MLCC do not contain these 15 substances.

For European Directive 2000/53/CE and 2005/673/CE : Cadmium, Hexavalent Chromium, Mercury, Lead are not contained in all TDK MLCC.

For European Directive 2003/11/CE : Pentabromodiphenyl-ether, Octabromodiphenyl-ether are not contained in all TDK MLCC.