

THIS DRAWING IS UNPUBLISHED.

RELEASED FOR PUBLICATION APR ,2003.

LOC GP DIST 00

REVISIONS

© COPYRIGHT 2003 By -

ALL RIGHTS RESERVED.

P	LTR	DESCRIPTION	DATE	DWN	APVD
	J	REVISED PER ECO-14-000651	06FEB2014	AP	SB

1 MATERIAL
 HOUSING : THERMOPLASTIC, UL94V-0, BLACK
 CONTACTS : PHOSPHOR BRONZE
 SHELL : STEEL
 SCREW : BRASS.
 BOARD LOCK : BRASS.
 SCREW OF TORQUE : 5 Kg-cm MAX.

2 FINISH
 CONTACT : 15µ" MIN.GOLD PLATING ON CONTACT AREA
 100µ" MIN. TIN PLATING ON SOLDERTAILS
 50µ" MIN. NICKEL UNDERPLATED OVERALL
 SHELL : 100µ" MIN NICKEL PLATING
 SCREW : 50µ" MIN. NICKEL PLATING.
 BOARD LOCK : 50µ" MIN. NICKEL PLATING.

3 CHARACTERISTICS
 CURRENT RATING : 3A
 INSULATION RESISTANCE : 1000MOHMS MIN, 500VDC FOR 2MINS.
 TEMPERATURE RATING : -55DEGC ~ +105DEGC
 VOLTAGE RATING : 250VDC

4 OBSOLETE PARTS: OBSOLETE CIS STREAMLINING PER D.RENAUD/D.SINISI.

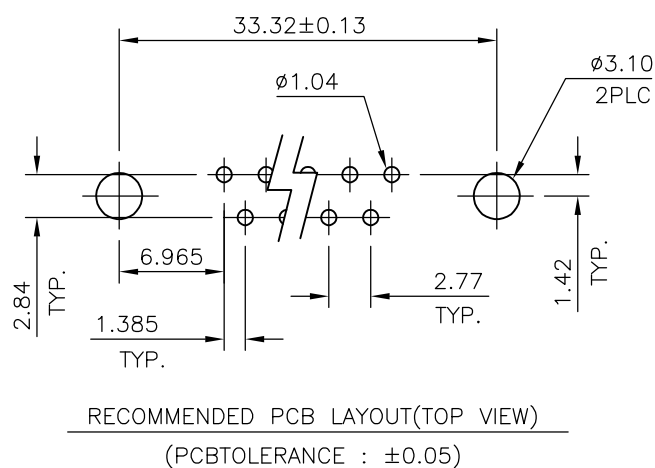
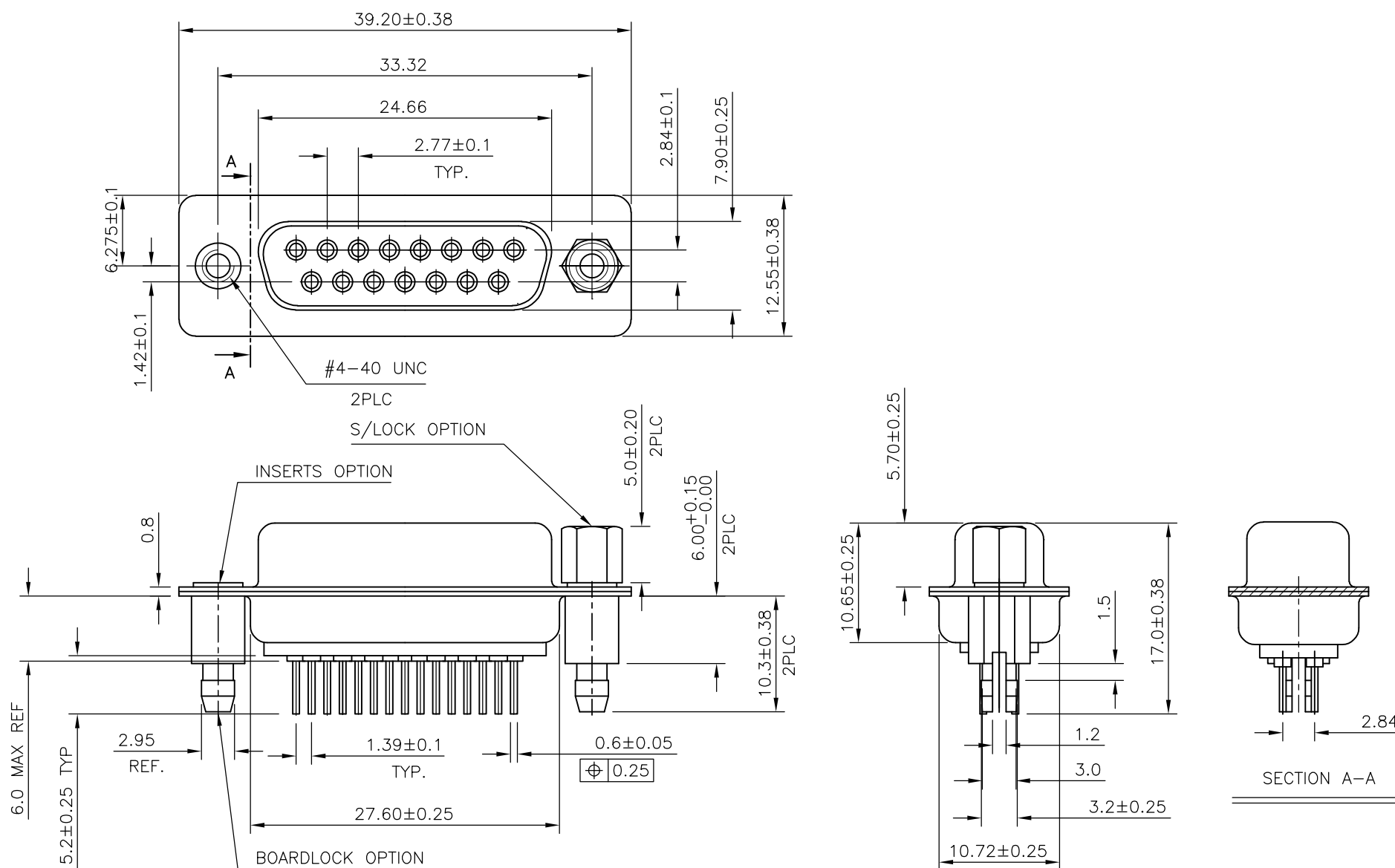

OBSOLETE	15W D SKT WITH B/L & M3 S/LOCK 15µ" GOLD	4-1634223-2
	15W D SKT WITH B/L & 4-40 S/LOCK 15µ" GOLD	3-1634223-2
4 OBSOLETE	15W D SKT WITH B/L & M3 INSERTS 15µ" GOLD	2-1634223-2
	15W D SKT WITH B/L & 4-40 INSERTS 15µ" GOLD	1-1634223-2
	DESCRIPTION	TE PART NO.

THIS DRAWING IS A CONTROLLED DOCUMENT.		DWN J.SANDWELL 10APR03	TE Connectivity	
DIMENSIONS: mm		CHK R.DYER 10APR03		
TOLERANCES UNLESS OTHERWISE SPECIFIED:		APVD F.WHEELER-KING 10APR03	NAME	
0 PLC ± -	1 PLC ± 0.25	PRODUCT SPEC	D-SUB HD20, VERTICAL, 15P SKT CONNECTOR	
2 PLC ± 0.15	3 PLC ± -	APPLICATION SPEC	SIZE	CAGE CODE
4 PLC ± -	ANGLES ± -	WEIGHT	A3	00779
MATERIAL -	FINISH -	CUSTOMER DRAWING	DRAWING NO	RESTRICTED TO
			G-1634223	-
		SCALE 2:1	SHEET 1 OF 2	REV J

THIS DRAWING IS UNPUBLISHED.

RELEASED FOR PUBLICATION APR , 2003.

© COPYRIGHT 2003 By -

ALL RIGHTS RESERVED.

LOC	DIST	REVISIONS					
GP	00	P	LTR	DESCRIPTION	DATE	DWN	APVD
		-		SEE SHEET 1	-	-	-

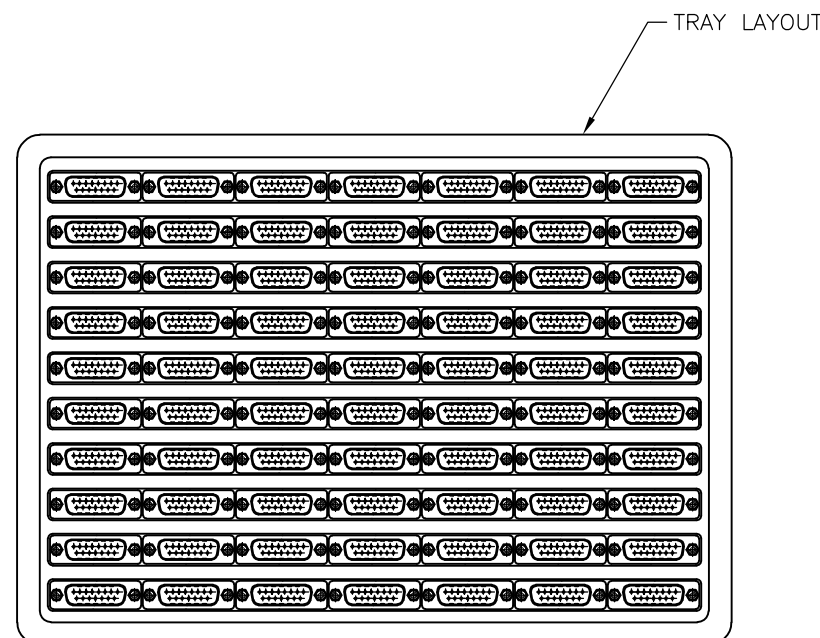
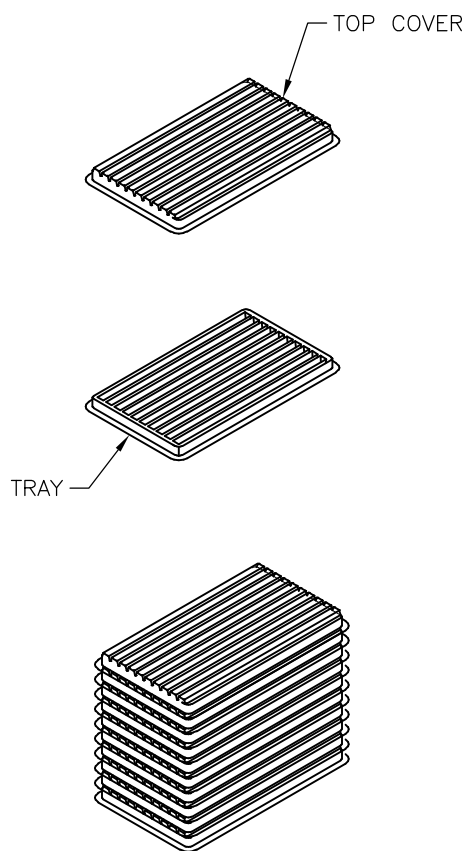

MATERIAL
 1 TRAY: PVC
 2 SHIPPING CARTON: CORRUGATED FIBERBOARD

DIMENSIONS
 1 TRAY: L=310, W=230, H=21
 2 SHIPPING CARTON: L=330, W=245, H=160

QUANTITY
 70 PCS/TRAY
 10 TRAY/SHIPPING CARTON

THIS DRAWING IS A CONTROLLED DOCUMENT.		DWN J.SANDWELL 10APR03	 TE Connectivity														
DIMENSIONS: mm		CHK R.DYER 10APR03															
TOLERANCES UNLESS OTHERWISE SPECIFIED:		APVD F.WHEELER-KING 10APR03	NAME D-SUB HD20, VERTICAL, 15P SKT CONNECTOR														
<table border="1"> <tr><td>0 PLC</td><td>± -</td></tr> <tr><td>1 PLC</td><td>± 0.25</td></tr> <tr><td>2 PLC</td><td>± 0.15</td></tr> <tr><td>3 PLC</td><td>± -</td></tr> <tr><td>4 PLC</td><td>± -</td></tr> <tr><td>ANGLES</td><td>± -</td></tr> </table>		0 PLC	± -	1 PLC	± 0.25	2 PLC	± 0.15	3 PLC	± -	4 PLC	± -	ANGLES	± -	PRODUCT SPEC -	-		
0 PLC	± -																
1 PLC	± 0.25																
2 PLC	± 0.15																
3 PLC	± -																
4 PLC	± -																
ANGLES	± -																
MATERIAL -		FINISH -	APPLICATION SPEC -	WEIGHT -	RESTRICTED TO -												
CUSTOMER DRAWING			SIZE A3	CAGE CODE 00779	DRAWING NO C-1634223												
			SCALE 2:1	SHEET 2 OF 2	REV J												