

Pushbutton Switches, 22mm, Oil-Tight, Round

FEATURES

- Fits 7/8" (22mm) diameter holes
- Full size buttons
- Meets NEMA 1, 12 and 13
- Rugged heavy-duty metal bushing, or thermoplastic bushings for full installation
- Matte black beveled frame finish
- IP65 protection level
- Snap-block contacts
- 6A @ 600VAC, 6A @ 125VDC V40, V50, F40, F50
6A @ 600VAC, 4A @ 125VDC VAO, VRO, FAO, FRO
- Easy "no tool" mounting
- Choice of screw terminals or dual .110/.250 quick connects
- Double-break silver contacts standard, gold plated optional
- Stackable

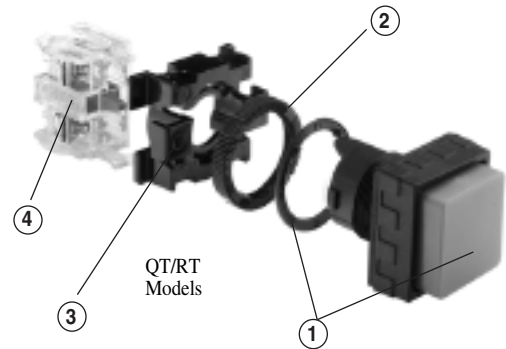
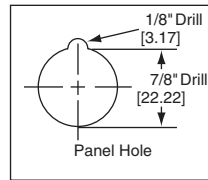
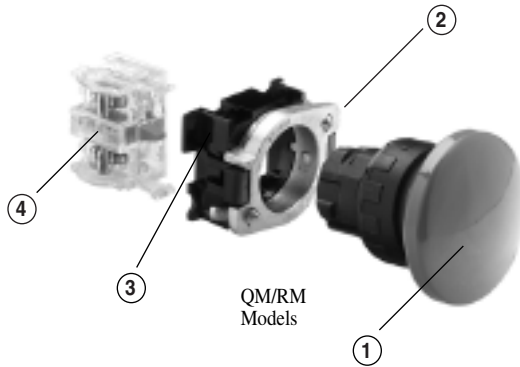

INSTALLATION & ASSEMBLY

- Engage the operator (1) into the 22.5mm dia. mounting hole.
- Engage metal ring (2) with operator (bayonet lock). Tighten set screws against back of panel.
- Snap the contact blocks (4) on the support(3).
- Snap the support (3) complete with contact blocks (4) on the metal ring (2).

- Engage the operator and seal (1) into the 22.5mm dia. mounting hole.
- Mount back-up nut (2) on bushing and then tighten against panel.
- Snap the contact blocks (4) on the support (3).
- Snap the support (3) complete the contact blocks (4) onto operator (1).

MOMENTARY

Metal Bushings

Contact blocks not supplied, order separately.
(See page I8.)

Model	Type
RM010(*)	Flush Button
RM020(*)	Extended Button
RM015(*)	Extended Guard

(*) Specify color by adding suffix number:
(0) Black, (2) Red, (4) Yellow, (5) Green, (6) Blue, (8) Grey, (9) White.
Note: Front beveled frame is black.

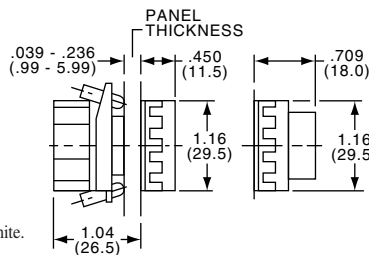

RM020(*)

Thermoplastic Bushings (Threaded)

Contact blocks not supplied, order separately.
(See page I8.)

Model	Type
RT010(*)	Flush Button
RT020(*)	Extended Button

(*) Specify color by adding suffix number:
(0) Black, (2) Red, (4) Yellow, (5) Green, (6) Blue, (8) Grey, (9) White.
Note: Front beveled frame is black.

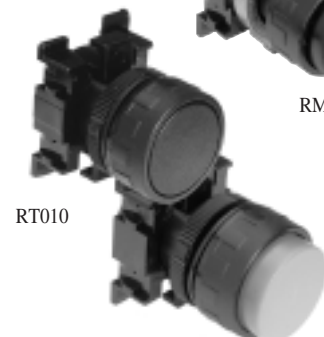
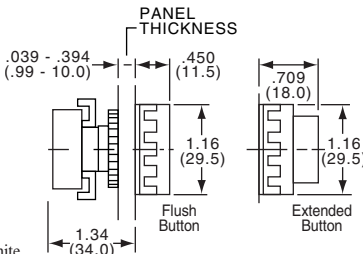

RT020

Pushbutton Switches, 22mm, Oil-Tight, Round or Mushroom or Dual Button



RM0502

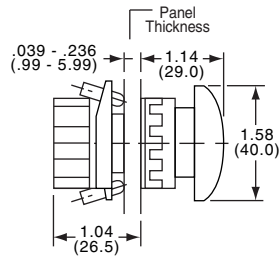

MOMENTARY

Mushroom

Contact blocks not supplied, order separately. (See page I8.)

Tyco Electronics	Alcoswitch	Type	Bushing
3-1437614-7	RM0502	Mushroom, Red	Metal, Bayonet
1437615-2	RT0502	Mushroom, Red	Thermoplastic, Threaded Bushing
3-1437614-6	RM0500	Mushroom, Black	Metal, Bayonet
1437615-1	RT0500	Mushroom, Black	Thermoplastic, Threaded Bushing
3-1437614-9	RM0552	Mushroom, Red	Metal, Bayonet (Wobble)
	RT050(*)	Mushroom	

(*) Specify color by adding suffix number:

(0) Black, (2) Red, (4) Yellow, (5) Green, (6) Blue.

Note: Front beveled frame is black.



RM0652

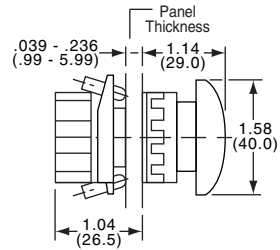

PUSH-TO-LOCK, TWIST-RELEASE

Metal Bushings

Contact blocks not supplied, order separately. (See page I8.)

Note: Use F40/V40 for N.C. contacts, and FAO/VAO for N.O. contacts.

Tyco Electronics	Alcoswitch	Type	Arrow
4-1437614-0	RM0652	Mushroom, Red	White

Note: Front beveled frame is black.



RM030(*)

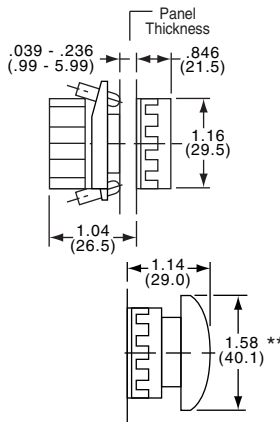

MAINTAINED

Contact blocks not supplied, order separately. (See page I8.)

Note: Use F40/V40 for N.C. contacts and FAO/VAO for N.O. contacts.

Tyco Electronics	Alcoswitch	Type
—	RM030(*)	Flush Button
3-1437614-4	RM0450	Mushroom, Black
3-1437614-5	RM0452	Mushroom, Red
3-1437614-8	RM0532	Push-Pull, Mushroom, Red

(*) Specify color by adding suffix number:

(0) Black, (2) Red, (4) Yellow, (5) Green, (6) Blue, (8) Grey, (9) White.

Note: Front beveled frame is black.

**** Note: RM0532 mushroom 35mm Dia. (1.38)**

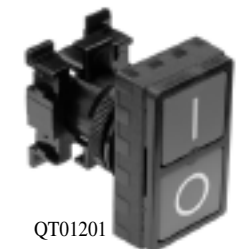

QT01201

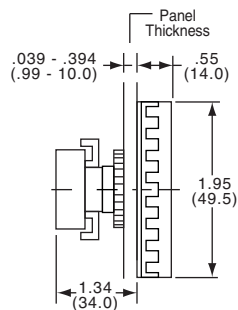

MOMENTARY DUAL OPERATOR*

Threaded Thermoplastic bushing

Contact blocks not supplied, order separately. (See page I8.)

Black buttons available.

Tyco Electronics	Alcoswitch	Color	Legend
1437614-9	QT01201	Green, Red	As Shown
—	QT012STSTH	Green, Red	Start & Stop Horizontal

*Not oil tight construction, not sealed; meets NEMA 1 only.

Note: Front beveled frame is black.

Pushbutton or Keylock or Selector Switches, 22mm, Oil-Tight

MOMENTARY

Metal Bushings

Contact blocks not supplied, order separately. (See page I8.)

Model	Type
QM010(*)	Flush Button
QM020(*)	Extended Button

(*) Specify color by adding suffix number:

(0) Black, (2) Red, (4) Yellow, (5) Green, (6) Blue, (8) Grey, (9) White.

Note: Front beveled frame is black.

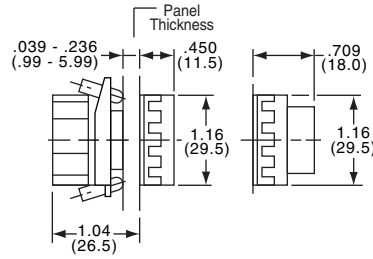

QM010(*)

Thermoplastic Bushings (Threaded)

Contact blocks not supplied, order separately. (See page I8.)

Model	Type
QT010(*)	Flush Button
QT020(*)	Extended Button

(*) Specify color by adding suffix number:

(0) Black, (2) Red, (4) Yellow, (5) Green, (6) Blue, (8) Grey, (9) White.

Note: Front beveled frame is black.

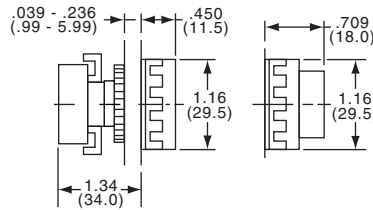

QT010(*)

2 POSITION SELECTORS/KEYLOCK MAINTAINED

Metal Bushings

Contact blocks not supplied, order separately. (See page I8.)

Tyco Electronics	Alcoswitch	Action	Throw	CAM	Remove Key
7-1437614-7	RM4040	Maintained, Black	120°	1	Long Selector
7-1437614-0	RM3040	Maintained, Black	120°	1	Selector
5-1437614-4	RM200	Maintained	60°	1	⊕
5-1437614-5	RM201	Maintained	60°	1	⊗
6-1437614-5	RM250	Momentary, Right	60°	1	⊕
5-1437614-6	RM204	Maintained	120°	1	⊗
5-1437614-7	RM205	Maintained	120°	1	⊗
1437614-1	E1	Spare Key			⊗

Note: Front beveled frame is black.

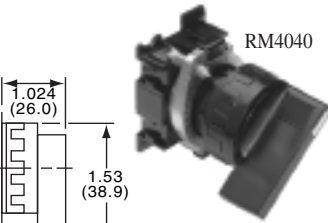
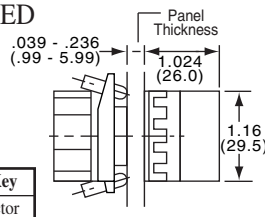

RM4040

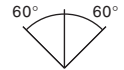

RM3040



RM200/201 with/2 keys

3 POSITION SELECTORS

Short Handle, Metal Bushings

Contact blocks not supplied, order separately. (See page I8.)

Tyco Electronics	Alcoswitch	Action	CAM	Tyco Electronics	Alcoswitch	Action	CAM
7-1437614-1	RM3100	Maintained, Black	2	7-1437614-4	RM3700	Momentary, Right Side, Black	2
7-1437614-2	RM3120	Maintained, Black	3	7-1437614-5	RM3800	Double Momentary, Black	2
7-1437614-3	RM3130	Maintained, Black	4	7-1437614-6	RM3830	Double Momentary, Black	4

Note: Front beveled frame is black.

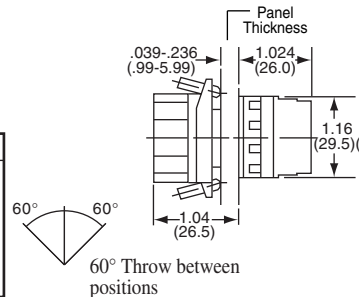

RM3100

Long Handle, Metal Bushings

Contact blocks not supplied, order separately. (See page I8.)

Tyco Electronics	Alcoswitch	Action	CAM	Tyco Electronics	Alcoswitch	Action	CAM
7-1437614-8	RM4100	Maintained	2	—	RM4700	Momentary, Right Side	2
—	RM4120	Maintained	3	7-1437614-9	RM4800	Double Momentary	2
—	RM4130	Maintained	4				

Note: Front beveled frame is black.

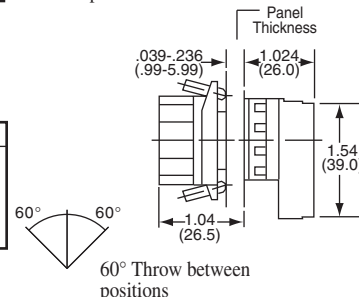

RM4100

Keylock or Pushbutton Switches, 22mm, Oil-Tight or Pilot Lights

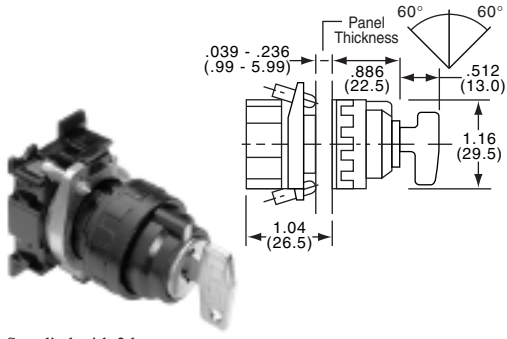

Supplied with 2 keys

3 POSITION KEYLOCK SELECTOR MAINTAINED OR MOMENTARY

Metal Bushings

Contact blocks not supplied, order separately. (See page I8.)

Tyco Electronics	Alcoswitch	Action	CAM	Remove Key	Tyco Electronics	Alcoswitch	Action	CAM	Remove Key
5-1437614-8	RM210	Maintained	2	⊙	6-1437614-4	RM243	Maintained	4	⊙
5-1437614-9	RM220	Maintained	2	⊙	6-1437614-6	RM270	Mom. Right Side	2	⊙
6-1437614-0	RM222	Maintained	3	⊙	6-1437614-7	RM272	Mom. Right Side	3	⊙
6-1437614-1	RM230	Maintained	2	⊙	6-1437614-8	RM273	Mom. Right Side	4	⊙
6-1437614-2	RM232	Maintained	3	⊙	6-1437614-9	RM280	Mom. Both Sides	2	⊙
6-1437614-3	RM233	Maintained	4	⊙	1437614-1	E1	Spare Key		⊙
—	RM240	Maintained	2	⊙					

Note: Front beveled frame is black.



QM600 (RM600)

Metal Bushing



SR601 Threaded Thermoplastic Bushing Front lampable

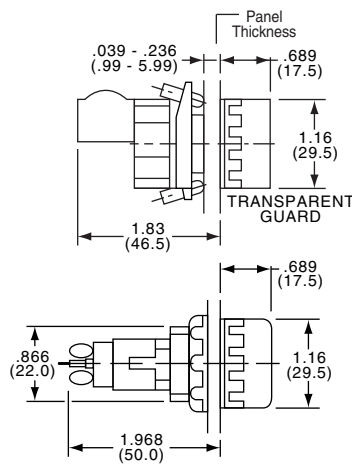

PILOT LIGHTS (FULL VOLTAGE TYPE)

Lamps: order separately, miniature bayonet base. (See page I15.)

Lamps: use G3 1/2 on QM600(*), use T3 1/4 on SR601(*), RM600(*). Custom legends available.

Model	Type
QM600(*)	Square pilot light, metal bushing
SR601(*)	Round pilot light, plastic bushing screw turn
RM600(*)	Round pilot light, metal bushing

(*) Specify color by adding suffix number: (2) Red, (3) Orange, (4) Yellow, (5) Green, (6) Blue, (9) White.

Reliant'22

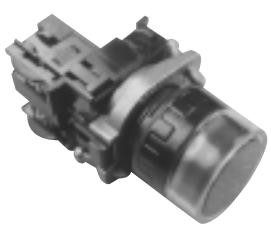

RM120(*)

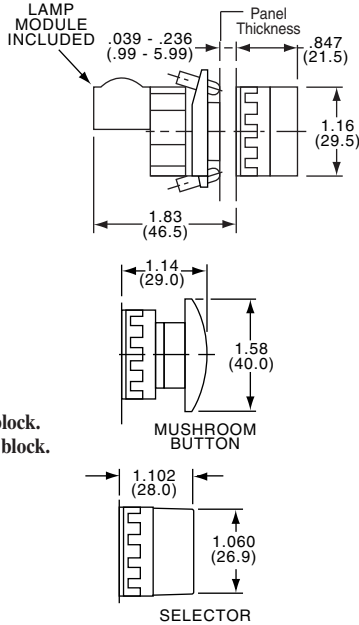

Application Note:
+V40/F40 used for N.C contact block.
+VA0/FA0 used for N.O. contact block.

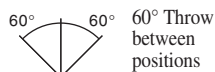

ILLUMINATED/ROUND MOMENTARY/MAINTAINED

Metal Bushing

Contact blocks not supplied, order separately. (See page I8.)

Lamp circuit isolated. Order lamp separately. (See page I15.)

Lamps: Use T-3 1/4 or G3 1/2 incandescent or neon lamps.

Tyco Electronics	Alcoswitch	Action	Type	Cam Type
—	RM120(*)	Momentary	Extended Button	
—	RM122(*)	Momentary	Guarded Button	
—	+RM130(*)	Maintained	Flush Button	} Push-On - Push-Off See Application Note
—	+RM145(*)	Maintained	Mushroom	
—	RM150(*)	Momentary	Mushroom	
5-1437614-3	RM1652	Twist Release	Mushroom, Red	
Illuminated Selectors				
—	RM650(*)	Maintained	2-Pos. Selector**1	
—	RM653(*)	Maintained	3-Pos. Selector**2	

When operating from line voltage use step down transformers 5B0 or 570. (See page I15.)
(*) Specify color by adding suffix number: (2) Red, (4) Yellow, (5) Green, (6) Blue, (9) White.

Note: RM145 and RM150 available only in red, yellow, green.

**Use G3 1/2 lamps only.

Note: Front beveled frame is black.

Pushbutton Switches, 22mm, Oil-Tight, Round or Square Buttons

SQUARE, MOMENTARY ILLUMINATED

Metal Bushing

Contact blocks not supplied, order separately. (See page I8.)

Lamp circuit isolated. Order lamps separately.

Lamps: Use G3 1/2. (See page I15.)

Custom legends available.

Model	Type
QM122(*)	Flush Button
QM120(*)	Extended Button

When operating from line voltage use step down transformers 5B0 or 570. (See page I15.)
 (*) Specify color by adding suffix number: (2) Red, (4) Yellow, (5) Green, (6) Blue, (9) White.

Note: Front beveled frame is black.

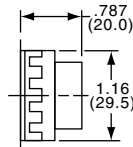
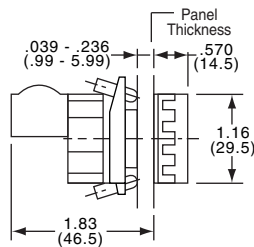

QM122(*)



QM120(*)

ROUND, MOMENTARY ILLUMINATED

Thermoplastic

Contact blocks not supplied, order separately. (See page I8.)

Lamp circuit isolated. Order lamps separately. (See page I15.)

Lamps: use T-3 1/4 or G3 1/2 incandescent or neon lamps.

Model	Action	Type
RT120(*)	Momentary	Extended Button

When operating from line voltage use step down transformers 5B0 or 570. (See page I15.)
 (*) Specify color by adding suffix number: (2) Red, (4) Yellow, (5) Green, (6) Blue, (9) White.

Note: Front beveled frame is black.

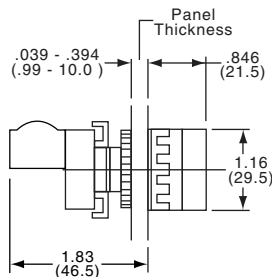

RT120(*)