

# FERRITE WIRE WOUND INDUCTORS

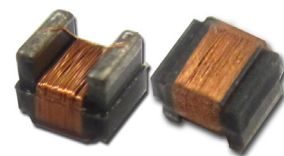

1.1 x 0.6 x 0.6mm

AISC-0402F



RoHS/RoHS II Compliant

## FEATURES:

- Higher inductance values than other 0402 inductors
- Ferrite construction for high current rating
- Inductance values: 18nH – 200nH; 5% tolerance available

## APPLICATIONS:

- Camcorders, LED TVs and other electronic devices

## STANDARD SPECIFICATIONS:

**Operating Temperature: -40°C to +85°C**

**Storage Temperature: -10°C to +40°C, 70% RH max. in tape and reel**

Part Number AISC-0402F- Inductance Code	Inductance	Tolerance	L Test Freq.	Max. DC Resistance	Max. Rated Current	Min. Self-resonant Frequency
Units	nH	-	MHz	$\Omega$	mA	MHz
Symbol	L	-	Freq.	DCR	I <sub>r</sub>	S.R.F
AISC-0402F-18N	18	J, K, M	100	0.046	1400	3000
AISC-0402F-33N	33	J, K, M	100	0.065	1300	1800
AISC-0402F-48N	48	J, K, M	100	0.078	1100	1400
AISC-0402F-70N	70	J, K, M	100	0.120	820	1300
AISC-0402F-96N	96	J, K, M	100	0.160	730	1100
AISC-0402F-R13	130	J, K, M	100	0.230	640	1000
AISC-0402F-R16	160	J, K, M	100	0.330	480	900
AISC-0402F-R22	200	J, K, M	100	0.470	390	800

## Test Equipment

Inductance (L): Agilent 4287A+Agilent 16197A or equivalent, -13dBm or 10mA

DC Resistance (DCR): HIOKI 3540 or equivalent

Q Factor (Q): Agilent4287A+Agilent16197A or equivalent, -13dBm or 10mA

Self-Resonant Frequency (SRF): Agilent4991B+Agilent16197A and HP 8753E or equivalent, -20dBm or 50mV

Rated Current (I<sub>r</sub>): I<sub>r</sub> is direct electric current as chip surface temperature rose just 40°C against chip initial surface temperature

## PART NUMBER IDENTIFICATION

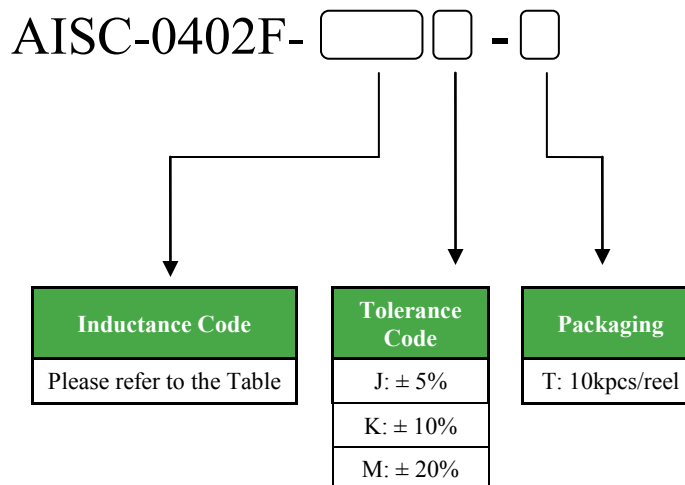

# FERRITE WIRE WOUND INDUCTORS

AISC-0402F



RoHS/RoHS II Compliant

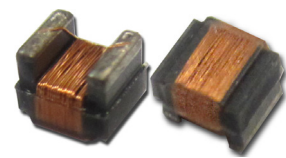

1.1 x 0.6 x 0.6mm

## OUTLINE DIMENSIONS:

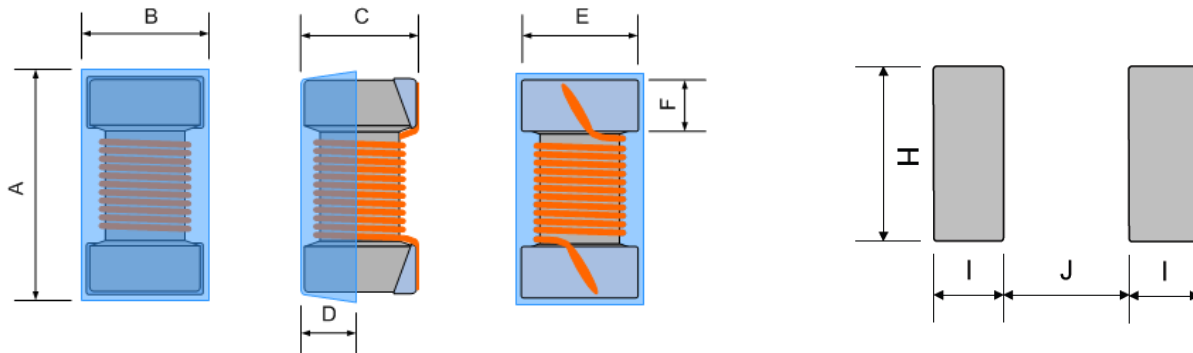

A	B	C	D Typ.	E	F	H REF.	I REF.	J REF.
1.1±0.1	0.6±0.1	0.6±0.1	0.25	0.5±0.1	0.2±0.1	0.65	0.35	0.50

## Materials

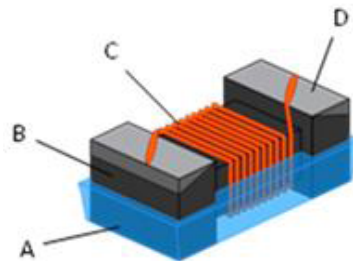

Dimension: mm

No.	Components	Material
A	Coating	Ultraviolet epoxy resin
B	Core	Ferrite
C	Wire	Polyurethane system enameled copper wire
D	Electrodes	Ag-Pd with Ni and Sn plating

## REFLOW PROFILE:

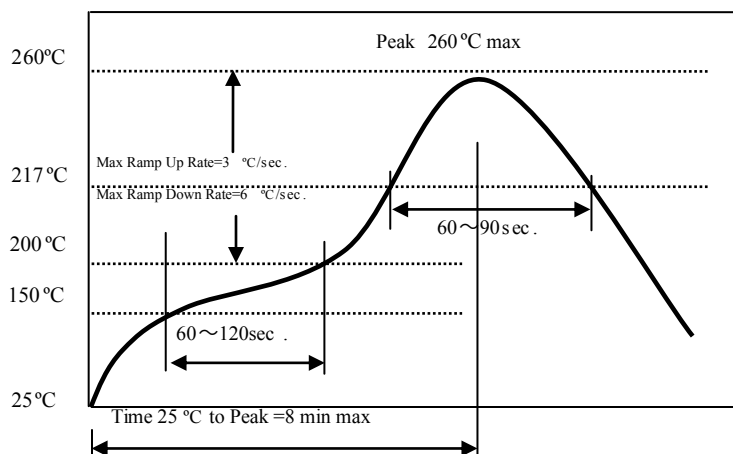

- Preheat condition: 150 ~200°C/60~120sec.
- Allowed time above 217 °C: 60~90sec.
- Max temp: 260 °C
- Max time at max temp: 10sec.
- Solder paste: Sn/3.0Ag/0.5Cu
- Allowed Reflow time: 2x max

# FERRITE WIRE WOUND INDUCTORS

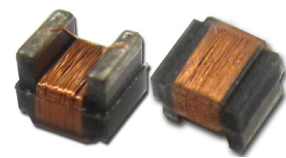

1.1 x 0.6 x 0.6mm

AISC-0402F



RoHS/RoHS II Compliant

## TAPE & REEL:

T= tape and reel (10,000pcs/reel)

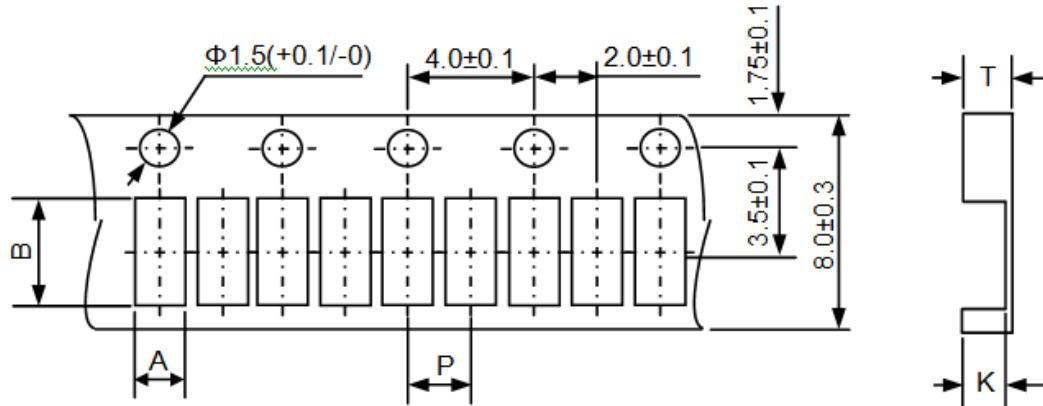

A	B	P	K	T
0.75±0.05	1.32±0.05	2.0±0.1	0.75±0.05	0.8±0.1

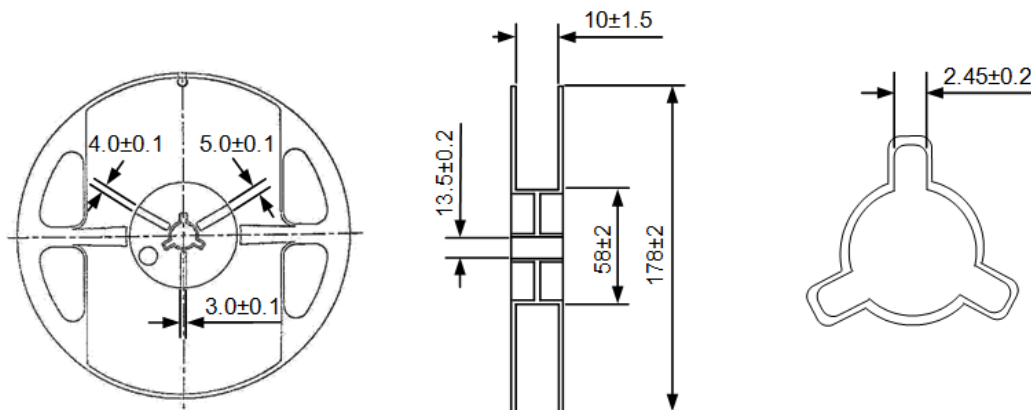

Dimension: mm

**ATTENTION:** Abracon Corporation's products are COTS – Commercial-Off-The-Shelf products; suitable for Commercial, Industrial and, where designated, Automotive Applications. Abracon's products are not specifically designed for Military, Aviation, Aerospace, Life-dependant Medical applications or any application requiring high reliability where component failure could result in loss of life and/or property. For applications requiring high reliability and/or presenting an extreme operating environment, written consent and authorization from Abracon Corporation is required. Please contact Abracon Corporation for more information.

ABRACON IS  
ISO 9001 :2008  
CERTIFIED



Visit [www.abracon.com](http://www.abracon.com) for Terms & Conditions of Sale  
30332 Esperanza, Rancho Santa Margarita, California 92688  
tel 949-546-8000 | fax 949-546-8001 | [www.abracon.com](http://www.abracon.com) **Revised: 09.29.14**