

General Description

- The AO6404 uses advanced trench technology to provide excellent $R_{DS(ON)}$, low gate charge and operation with gate voltages as low as 1.8V while retaining a 12V $V_{GS(MAX)}$ rating.
- RoHS and Halogen-Free Compliant

Product Summary

$V_{DS} (V) = 20V$
 $I_D = 8.6A (V_{GS} = 10V)$
 $R_{DS(ON)} < 17m\Omega (V_{GS} = 10V)$
 $R_{DS(ON)} < 18m\Omega (V_{GS} = 4.5V)$
 $R_{DS(ON)} < 24m\Omega (V_{GS} = 2.5V)$
 $R_{DS(ON)} < 33m\Omega (V_{GS} = 1.8V)$

ESD Rating: 2000V HBM

ESD Protected
 100% UIS Tested
 100% Rg Tested



Top View Bottom View

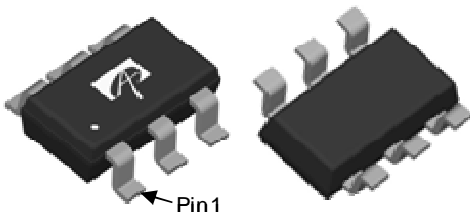

Top View

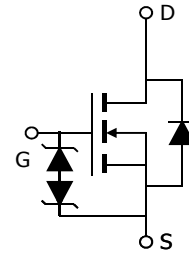
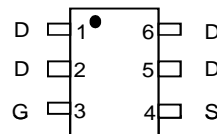

Orderable Part Number	Package Type	Form	Minimum Order Quantity
AO6404	TSOP6	Tape & Reel	3000

Absolute Maximum Ratings $T_A=25^\circ C$ unless otherwise noted

Parameter	Symbol	Maximum	Units
Drain-Source Voltage	V_{DS}	20	V
Gate-Source Voltage	V_{GS}	± 12	V
Continuous Drain Current ^A	$T_A=25^\circ C$	8.6	A
	$T_A=70^\circ C$	6.8	
Pulsed Drain Current ^B	I_{DM}	30	
Power Dissipation ^A	$T_A=25^\circ C$	2	W
	$T_A=70^\circ C$	1.28	
Junction and Storage Temperature Range	T_J, T_{STG}	-55 to 150	$^\circ C$

Thermal Characteristics

Parameter	Symbol	Typ	Max	Units
Maximum Junction-to-Ambient ^A	$R_{\theta JA}$	45	62.5	$^\circ C/W$
Maximum Junction-to-Ambient ^A		Steady-State	70	110
Maximum Junction-to-Lead ^C	$R_{\theta JL}$	33	50	$^\circ C/W$

Electrical Characteristics (T_J=25°C unless otherwise noted)

Symbol	Parameter	Conditions	Min	Typ	Max	Units
STATIC PARAMETERS						
BV _{DSS}	Drain-Source Breakdown Voltage	I _D =250μA, V _{GS} =0V	20			V
I _{DSS}	Zero Gate Voltage Drain Current	V _{DS} =16V, V _{GS} =0V T _J =55°C			10 25	μA
I _{GSS}	Gate-Body leakage current	V _{DS} =0V, V _{GS} =±10V			10	μA
BV _{GSO}	Gate-Source Breakdown Voltage	V _{DS} =0V, I _G =±250μA	±12			V
V _{GS(th)}	Gate Threshold Voltage	V _{DS} =V _{GS} I _D =250μA	0.5	0.75	1	V
I _{D(ON)}	On state drain current	V _{GS} =4.5V, V _{DS} =5V	30			A
R _{DS(ON)}	Static Drain-Source On-Resistance	V _{GS} =10V, I _D =8.5A T _J =125°C		13.4	17	mΩ
		V _{GS} =4.5V, I _D =5A		14.8	18	
		V _{GS} =2.5V, I _D =4A		18.8	24	mΩ
		V _{GS} =1.8V, I _D =3A		25.5	33	mΩ
g _{FS}	Forward Transconductance	V _{DS} =5V, I _D =8A		36		S
V _{SD}	Diode Forward Voltage	I _S =1A, V _{GS} =0V		0.73	1	V
I _S	Maximum Body-Diode Continuous Current				2.9	A
DYNAMIC PARAMETERS						
C _{iss}	Input Capacitance	V _{GS} =0V, V _{DS} =10V, f=1MHz		1810	2200	pF
C _{oss}	Output Capacitance			232		pF
C _{rss}	Reverse Transfer Capacitance			200		pF
R _g	Gate resistance	V _{GS} =0V, V _{DS} =0V, f=1MHz		1.6	2.2	Ω
SWITCHING PARAMETERS						
Q _g	Total Gate Charge	V _{GS} =4.5V, V _{DS} =10V, I _D =8.5A		17.9	22	nC
Q _{gs}	Gate Source Charge			1.5		nC
Q _{gd}	Gate Drain Charge			4.7		nC
t _{D(on)}	Turn-On DelayTime	V _{GS} =10V, V _{DS} =10V, R _L =1.2Ω, R _{GEN} =3Ω		2.5		ns
t _r	Turn-On Rise Time			7.2		ns
t _{D(off)}	Turn-Off DelayTime			49		ns
t _f	Turn-Off Fall Time			10.8		ns
t _{rr}	Body Diode Reverse Recovery Time	I _F =8.5A, di/dt=100A/μs		22	27	ns
Q _{rr}	Body Diode Reverse Recovery Charge	I _F =8.5A, di/dt=100A/μs		9.8		nC

A: The value of R_{θJA} is measured with the device mounted on 1in² FR-4 board with 2oz. Copper, in a still air environment with T_A=25° C. The value in any given application depends on the user's specific board design. The current rating is based on the t ≤ 10s thermal resistance rating.

B: Repetitive rating, pulse width limited by junction temperature.

C: The R_{θJA} is the sum of the thermal impedance from junction to lead R_{θJL} and lead to ambient.

D: The static characteristics in Figures 1 to 6,12,14 are obtained using 80 μs pulses, duty cycle 0.5% max.

E: These tests are performed with the device mounted on 1 in² FR-4 board with 2oz. Copper, in a still air environment with T_A=25° C. The SOA curve provides a single pulse rating.

APPLICATIONS OR USE AS CRITICAL COMPONENTS IN LIFE SUPPORT DEVICES OR SYSTEMS ARE NOT AUTHORIZED. AOS DOES NOT ASSUME ANY LIABILITY ARISING OUT OF SUCH APPLICATIONS OR USES OF ITS PRODUCTS. AOS RESERVES THE RIGHT TO IMPROVE PRODUCT DESIGN,FUNCTIONS AND RELIABILITY WITHOUT NOTICE.

TYPICAL ELECTRICAL AND THERMAL CHARACTERISTICS

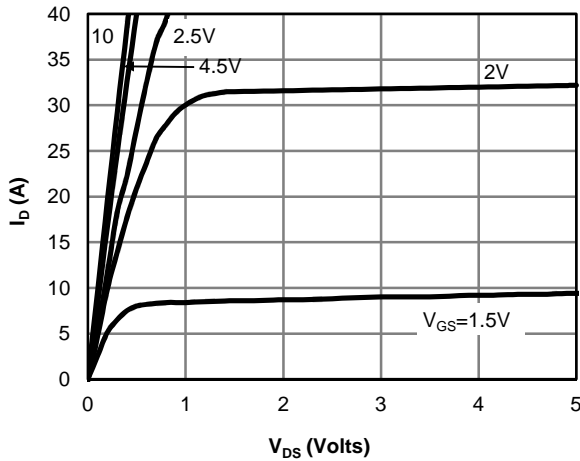

Fig 1: On-Region Characteristics

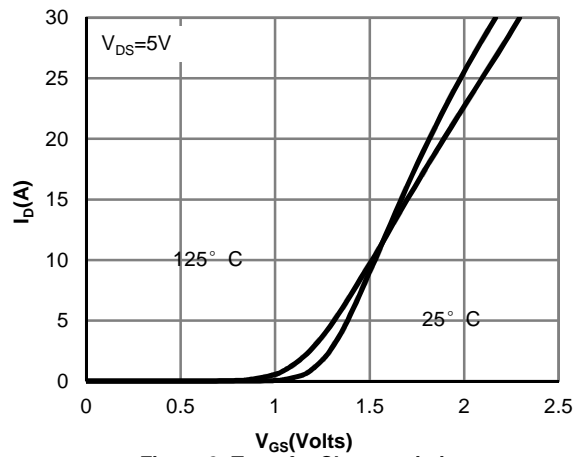

Figure 2: Transfer Characteristics

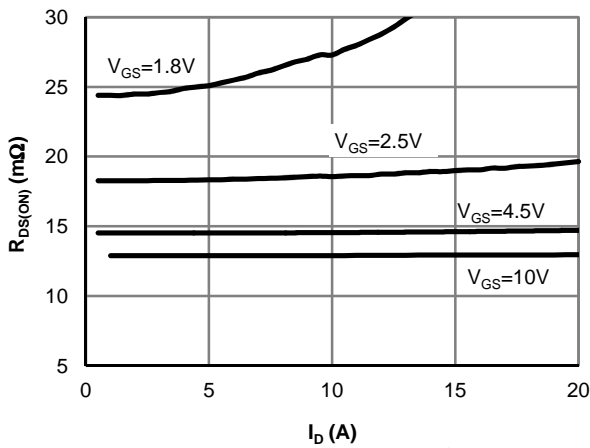

Figure 3: On-Resistance vs. Drain Current and Gate Voltage

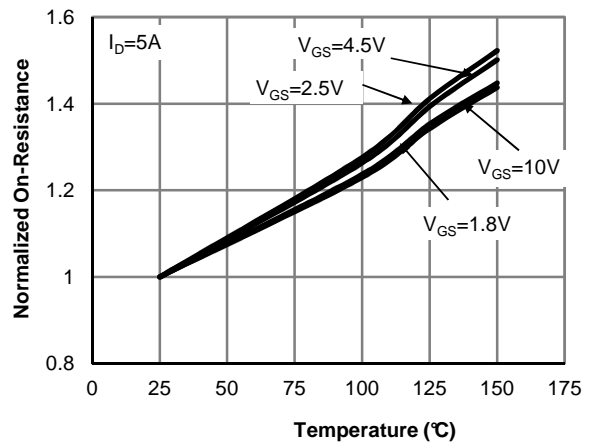

Figure 4: On-Resistance vs. Junction Temperature

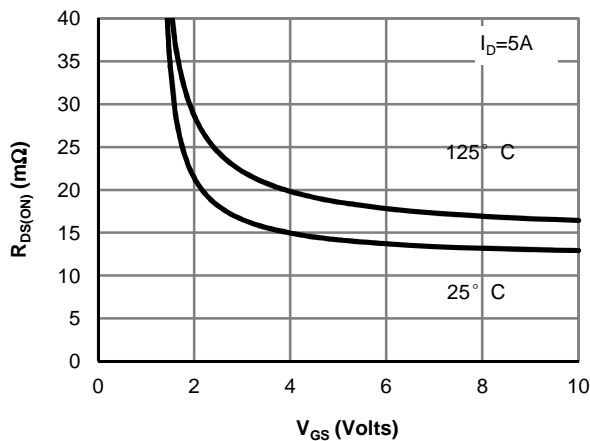

Figure 5: On-Resistance vs. Gate-Source Voltage

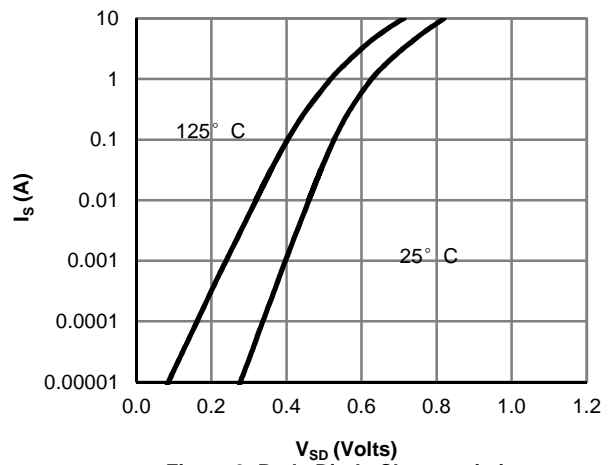

Figure 6: Body-Diode Characteristics

TYPICAL ELECTRICAL AND THERMAL CHARACTERISTICS

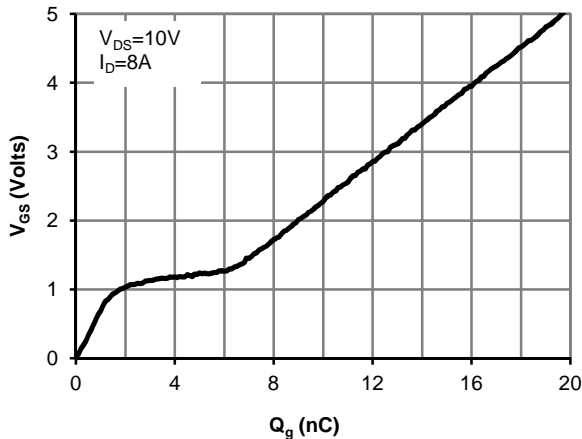

Figure 7: Gate-Charge Characteristics

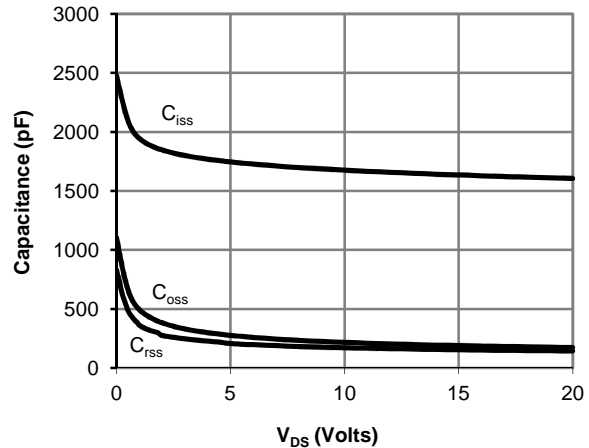

Figure 8: Capacitance Characteristics

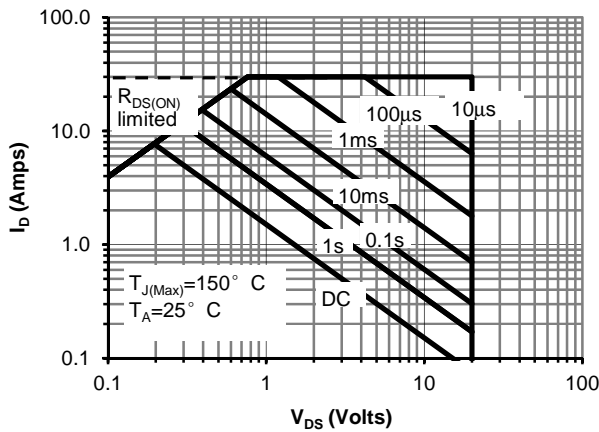

Figure 9: Maximum Forward Biased Safe Operating Area (Note E)

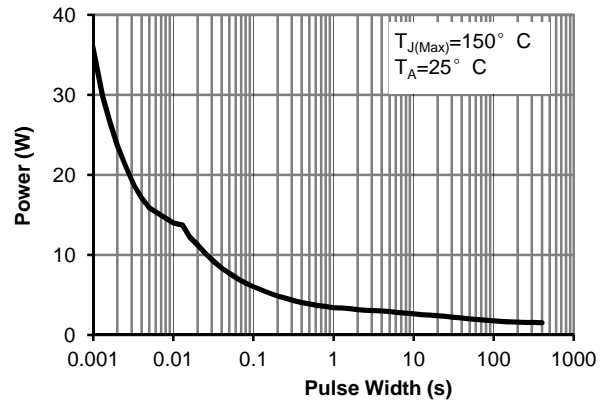

Figure 10: Single Pulse Power Rating Junction-to-Ambient (Note E)

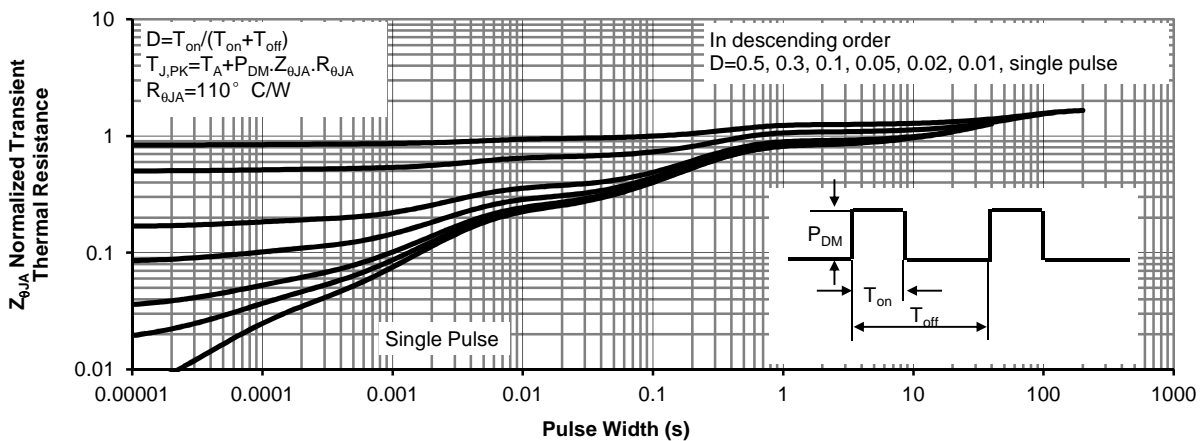

Figure 11: Normalized Maximum Transient Thermal Impedance

Figure A: Gate Charge Test Circuit & Waveforms

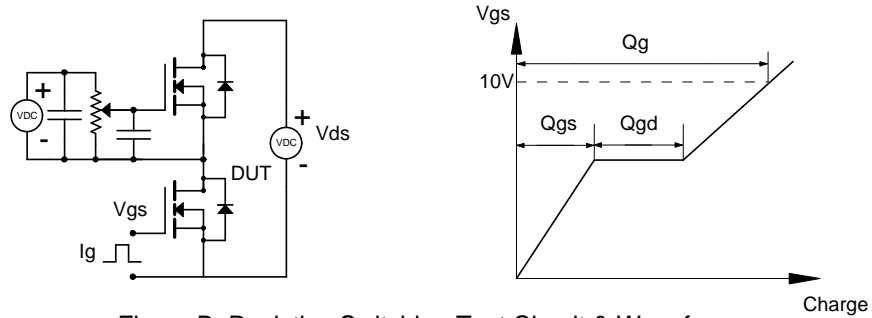

Figure B: Resistive Switching Test Circuit & Waveforms

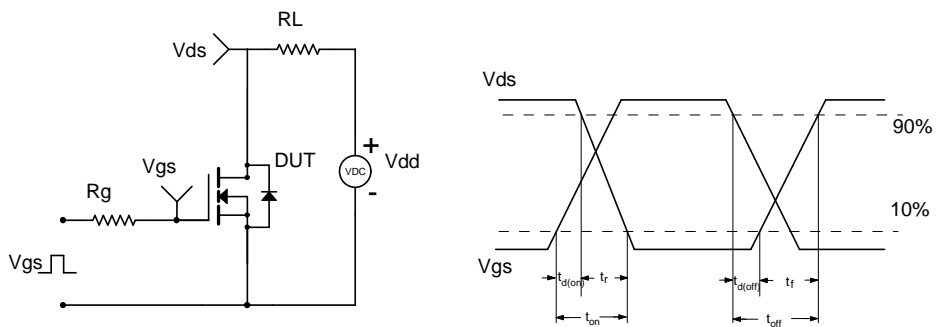

Figure C: Unclamped Inductive Switching (UIS) Test Circuit &

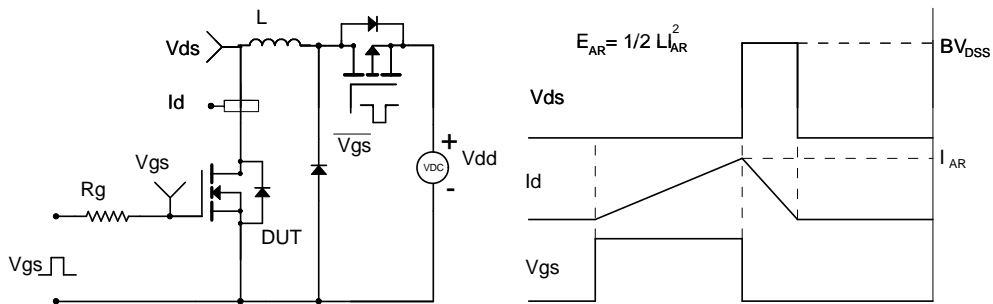

Figure D: Diode Recovery Test Circuit & Waveforms

