

## NQR010A0X4: Non-Isolated DC-DC Power Modules

### 4.5Vdc –14Vdc input; 0.59Vdc to 6Vdc Output;10A Output Current

**TUNABLE  
LOOP™**  
A LINEAGE POWER TRADEMARK

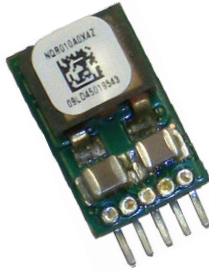

### RoHS Compliant

### Applications

- Distributed power architectures
- Intermediate bus voltage applications
- Telecommunications equipment
- Servers and storage applications
- Networking equipment
- Industrial applications

### Description

The NQR010A0X4 SIP power modules are non-isolated dc-dc converters in an industry standard package that can deliver up to 10A of output current with a full load efficiency of 94% at 5Vdc output voltage ( $V_{IN} = 12Vdc$ ). These modules operate over a wide range of input voltage ( $V_{IN} = 4.5Vdc-14Vdc$ ) and provide a precisely regulated output voltage from 0.59Vdc to 6Vdc, programmable via an external resistor. Features include remote On/Off, adjustable output voltage, over current and over temperature protection. A new feature, the Tunable Loop™, allows the user to optimize the dynamic response of the converter to match the load.

### Features

- Compliant to RoHS EU Directive 2002/95/EC (Z versions)
- Compatible in a Pb-free or SnPb wave-soldering environment (Z versions)
- Wide Input voltage range (4.5Vdc-14Vdc)
- Output voltage programmable from 0.59 Vdc to 6Vdc via external resistor
- Tunable Loop™ to optimize dynamic output voltage response
- Fixed switching frequency
- Output over current protection (non-latching)
- Over temperature protection
- Remote On/Off
- Small size: 10.4 mm x 16.5 mm x 8.4 mm  
(0.41 in x 0.65 in x 0.33 in)
- Wide operating temperature range (-40°C to 85°C)
- UL\* 60950-1 Recognized, CSA† C22.2 No. 60950-1-03 Certified, and VDE‡ 0805:2001-12 (EN60950-1) Licensed
- ISO\*\* 9001 and ISO 14001 certified manufacturing facilities

\* UL is a registered trademark of Underwriters Laboratories, Inc.

† CSA is a registered trademark of Canadian Standards Association.

‡ VDE is a trademark of Verband Deutscher Elektrotechniker e.V.

\*\* ISO is a registered trademark of the International Organization of Standards

## Absolute Maximum Ratings

Stresses in excess of the absolute maximum ratings can cause permanent damage to the device. These are absolute stress ratings only, functional operation of the device is not implied at these or any other conditions in excess of those given in the operations sections of the data sheet. Exposure to absolute maximum ratings for extended periods can adversely affect the device reliability.

Parameter	Device	Symbol	Min	Max	Unit
Input Voltage Continuous	All	$V_{IN}$	-0.3	15	Vdc
Operating Ambient Temperature (see Thermal Considerations section)	All	$T_A$	-40	85	°C
Storage Temperature	All	$T_{stg}$	-55	125	°C

## Electrical Specifications

Unless otherwise indicated, specifications apply over all operating input voltage, resistive load, and temperature conditions.

Parameter	Device	Symbol	Min	Typ	Max	Unit
Operating Input Voltage	All	$V_{IN}$	4.5	12	14	Vdc
Maximum Input Current ( $V_{IN}=4.5V$ to $14V$ , $I_O=I_{O,max}$ )	All	$I_{IN,max}$			10	Adc
Input No Load Current ( $V_{IN} = 12Vdc$ , $I_O = 0$ , module ON)	$V_{O,set} = 0.6 Vdc$	$I_{IN,No load}$		29		mA
( $V_{IN} = 12Vdc$ , $I_O = 0$ , module ON)	$V_{O,set} = 5.0Vdc$	$I_{IN,No load}$		58		mA
Input Stand-by Current ( $V_{IN} = 12Vdc$ , module disabled)	All	$I_{IN,stand-by}$		1.505		mA
Inrush Transient	All	$I^2t$			1	A <sup>2</sup> s
Input Reflected Ripple Current, peak-to-peak (5Hz to 20MHz, 1μH source impedance; $V_{IN}=0$ to 14V, $I_O=I_{O,max}$ ; See Test Configurations)	All			34		mAp-p
Input Ripple Rejection (120Hz)	All			58		dB

### Electrical Specifications (continued)

Parameter	Device	Symbol	Min	Typ	Max	Unit
Output Voltage Set-point (with 0.5% tolerance for external resistor used to set output voltage)	All	$V_{O, set}$	-1.5		+1.5	% $V_{O, set}$
Output Voltage (Over all operating input voltage, resistive load, and temperature conditions until end of life)	All	$V_{O, set}$	-3.0	—	+3.0	% $V_{O, set}$
Adjustment Range Selected by an external resistor	All	$V_O$	0.59		6	Vdc
Output Regulation (for $V_O \geq 2.5Vdc$ ) Line ( $V_{IN}=V_{IN, min}$ to $V_{IN, max}$ ) Load ( $I_O=I_{O, min}$ to $I_{O, max}$ )	All All		-0.2	—	+0.2 0.8	% $V_{O, set}$ % $V_{O, set}$
Output Regulation (for $V_O < 2.5Vdc$ ) Line ( $V_{IN}=V_{IN, min}$ to $V_{IN, max}$ ) Load ( $I_O=I_{O, min}$ to $I_{O, max}$ )	All All		-5	—	+5 20	mV mV
Output Ripple and Noise on nominal output ( $V_{IN}=V_{IN, nom}$ and $I_O=I_{O, min}$ to $I_{O, max}$ $C_{out} = 10\mu F$ ) Peak-to-Peak (5Hz to 20MHz bandwidth) Peak-to-Peak (5Hz to 20MHz bandwidth) Peak-to-Peak (5Hz to 20MHz bandwidth) Peak-to-Peak (5Hz to 20MHz bandwidth) Peak-to-Peak (5Hz to 20MHz bandwidth) Peak-to-Peak (5Hz to 20MHz bandwidth) Peak-to-Peak (5Hz to 20MHz bandwidth)	$V_O = 0.59Vdc$ $V_O = 1.2Vdc$ $V_O = 1.8Vdc$ $V_O = 2.5Vdc$ $V_O = 3.3Vdc$ $V_O = 5.0Vdc$ $V_O = 6.0Vdc$			17 22 30 34 42 50 53		mV <sub>pk-pk</sub> mV <sub>pk-pk</sub> mV <sub>pk-pk</sub> mV <sub>pk-pk</sub> mV <sub>pk-pk</sub> mV <sub>pk-pk</sub> mV <sub>pk-pk</sub>
External Capacitance <sup>1</sup> Without the Tunable Loop™ ESR $\geq 1 m\Omega$	All	$C_{O, max}$	10	—	200	$\mu F$
With the Tunable Loop™ ESR $\geq 0.15 m\Omega$ ESR $\geq 10 m\Omega$	All All	$C_{O, max}$ $C_{O, max}$	10 10	— —	1000 5000	$\mu F$ $\mu F$
Output Current	All	$I_O$	0		10	Adc
Output Current Limit Inception (Hiccup Mode )	All	$I_{O, lim}$		200		% $I_{O, max}$
Output Short-Circuit Current ( $V_O \leq 250mV$ ) ( Hiccup Mode )	All	$I_{O, s/c}$		0.65		Arms
Efficiency ( $V_{IN} = 6Vdc$ ) $V_{IN} = 12Vdc$ , $T_A = 25^\circ C$ $I_O = I_{O, max}$ , $V_O = V_{O, set}$	$V_{O, set} = 0.59Vdc$ $V_{O, set} = 1.2Vdc$ $V_{O, set} = 1.8Vdc$ $V_{O, set} = 2.5Vdc$ $V_{O, set} = 3.3Vdc$ $V_{O, set} = 5.0Vdc$ $V_{O, set} = 6.0Vdc$	$\eta$ $\eta$ $\eta$ $\eta$ $\eta$ $\eta$ $\eta$		73 82 87 90 92 94 95		% % % % % % %
Switching Frequency	All	$f_{sw}$	—	600	—	kHz

<sup>1</sup> External capacitors may require using the new Tunable Loop feature to ensure that the module is stable as well as getting the best transient response. See the Tunable Loop™ section for details.

### Electrical Specifications (continued)

Parameter	Device	Symbol	Min	Typ	Max	Unit
Dynamic Load Response (dI <sub>o</sub> /dt=10A/μs; V <sub>IN</sub> = V <sub>IN, nom</sub> ; V <sub>out</sub> = 1.8V, T <sub>A</sub> =25°C) Load Change from I <sub>o</sub> = 0% to 50% of I <sub>o,max</sub> ; C <sub>o</sub> = 10μF Peak Deviation	All	V <sub>pk</sub>		280		mV
Settling Time (V <sub>o</sub> <10% peak deviation)	All	t <sub>s</sub>		40		μs
Load Change from I <sub>o</sub> = 50% to 0% of I <sub>o,max</sub> ; C <sub>o</sub> = 10μF Peak Deviation	All	V <sub>pk</sub>		325		mV
Settling Time (V <sub>o</sub> <10% peak deviation)	All	t <sub>s</sub>		40		μs

### General Specifications

Parameter	Min	Typ	Max	Unit
Calculated MTBF (V <sub>IN</sub> =12V, V <sub>O</sub> =5Vdc, I <sub>O</sub> =0.8I <sub>O, max</sub> , T <sub>A</sub> =40°C) Per Telcordia Method		6,925,356		Hours
Weight	—	2.5 (0.088)	—	g (oz.)

## Feature Specifications

Unless otherwise indicated, specifications apply over all operating input voltage, resistive load, and temperature conditions. See Feature Descriptions for additional information.

Parameter	Device	Symbol	Min	Typ	Max	Unit
On/Off Signal interface ( $V_{IN}=V_{IN, min}$ to $V_{IN, max}$ ; Open collector or equivalent signal referenced to GND) Logic High (On/Off pin open - Module ON)						
Input High Current	All	$I_{IH}$		—	0.5	mA
Input High Voltage	All	$V_{IH}$	1.0	—	$V_{IN, max}$	V
Logic Low (Module Off)						
Input Low Current	All	$I_{IL}$	—	—	200	$\mu$ A
Input Low Voltage	All	$V_{IL}$	-0.3	—	0.4	V
Turn-On Delay and Rise Times ( $I_O=I_{O, max}$ , $V_{IN} = V_{IN, nom}$ , $V_O$ to within $\pm 1\%$ of steady state)						
Case 1: On/Off input is enabled and then input power is applied (delay from instant at which $V_{IN} = V_{IN, min}$ until $V_O=10\%$ of $V_{O, set}$ )	All	$T_{delay}$			3	msec
Case 2: Input power is applied for at least one second and then On/Off input is set enabled (delay from instant at which On/Off is enabled until $V_O=10\%$ of $V_{O, set}$ )	All	$T_{delay}$			3	msec
Output voltage Rise time (time for $V_O$ to rise from 10% of $V_{O, set}$ to 90% of $V_{O, set}$ )	All	$T_{rise}$			5	msec
Output voltage overshoot $I_O= I_{O, max}$ ; $V_{IN} = V_{IN, min}$ to $V_{IN, max}$ , $T_A = 25^\circ\text{C}$					1.5	% $V_{O, set}$
Overtemperature Protection	All	$T_{ref}$		145		$^\circ\text{C}$
Input Undervoltage Lockout						
Turn-on Threshold	All			4.25		Vdc
Turn-off Threshold	All			3.66		Vdc

### Characteristic Curves

The following figures provide typical characteristics for the NQR010 module at 0.6V<sub>out</sub> and at 25°C.

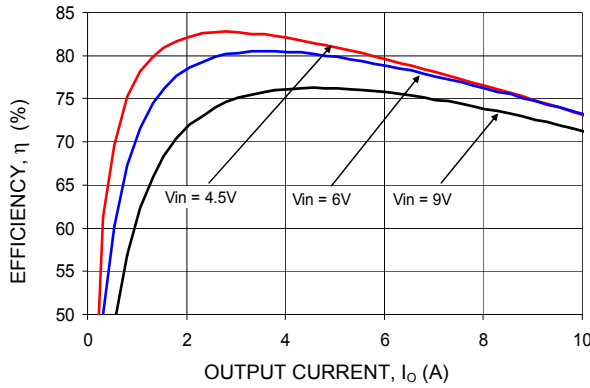

Figure 1. Converter Efficiency versus Output Current.

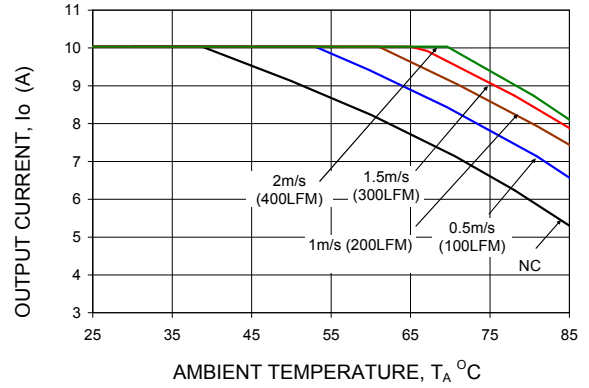

Figure 2. Derating Output Current versus Ambient Temperature and Airflow.

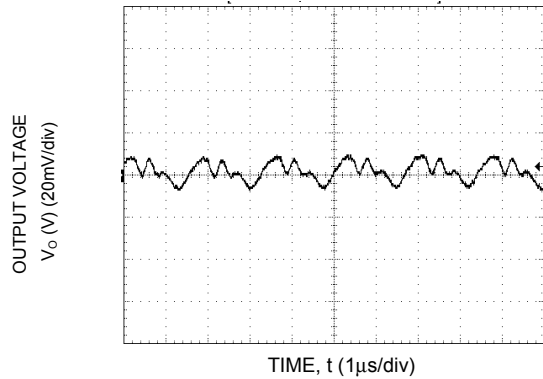

Figure 3. Typical output ripple and noise ( $V_{IN} = 9V$ ,  $I_o = I_{o,max}$ ).

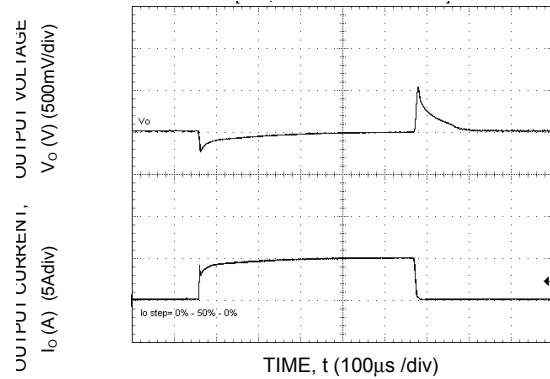

Figure 4. Transient Response to Dynamic Load Change from 0% to 50% to 0% with  $V_{IN}=9V$ .

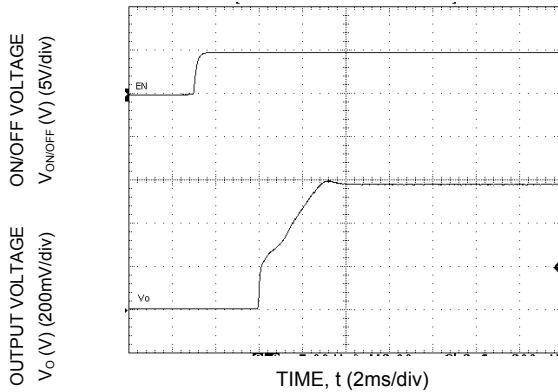

Figure 5. Typical Start-up Using On/Off Voltage ( $I_o = I_{o,max}$ ).

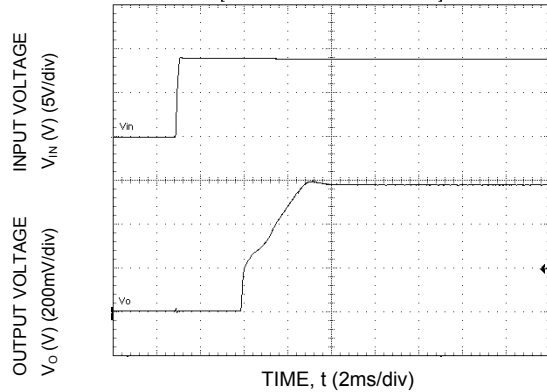
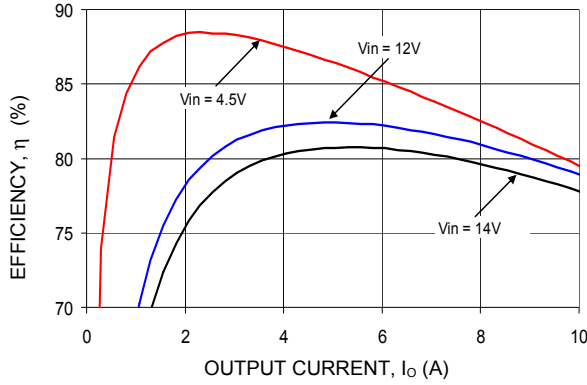

Figure 6. Typical Start-up Using Input Voltage ( $V_{IN} = 9V$ ,  $I_o = I_{o,max}$ ).

**Characteristic Curves (continued)**

The following figures provide typical characteristics for the NQR010 module at 1.2V<sub>out</sub> and at 25°C.



**Figure 7. Converter Efficiency versus Output Current.**

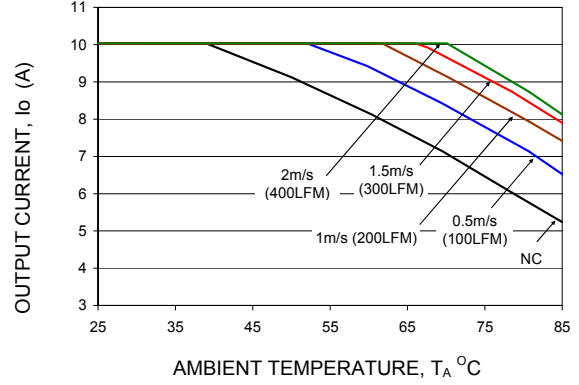

**Figure 8. Derating Output Current versus Ambient Temperature and Airflow.**

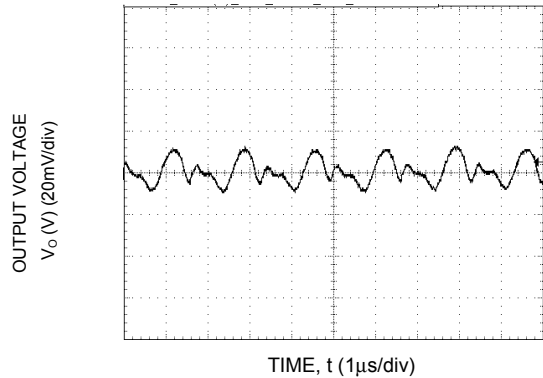

**Figure 9. Typical output ripple and noise (VIN = 12V, Io = Io,max).**

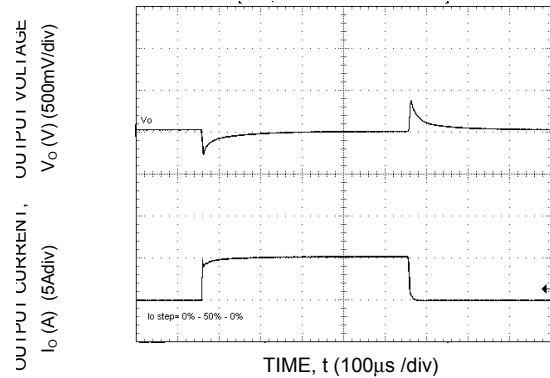

**Figure 10. Transient Response to Dynamic Load Change from 0% to 50% to 0% with VIN=12V.**

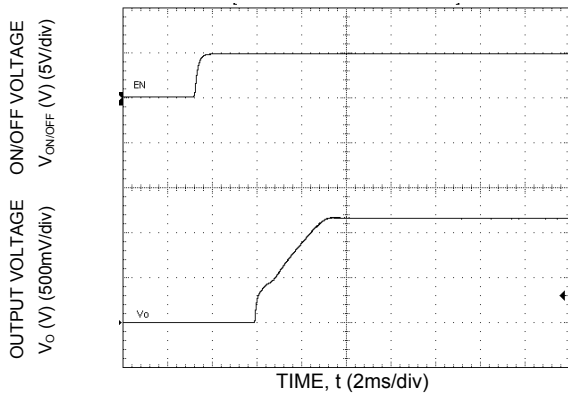

**Figure 11. Typical Start-up Using On/Off Voltage (Io = Io,max).**

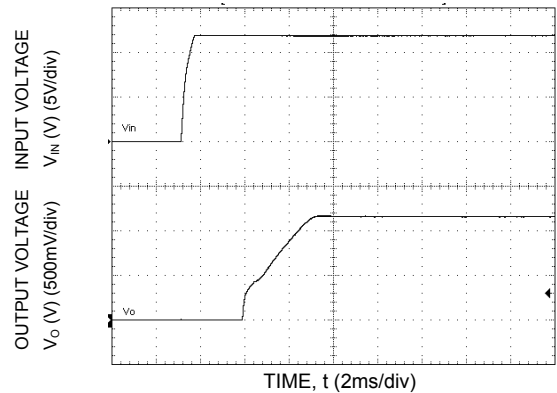

**Figure 12. Typical Start-up Using Input Voltage (VIN = 12V, Io = Io,max).**

### Characteristic Curves (continued)

The following figures provide typical characteristics for the NQR010 module at 1.8V<sub>out</sub> and at 25°C.

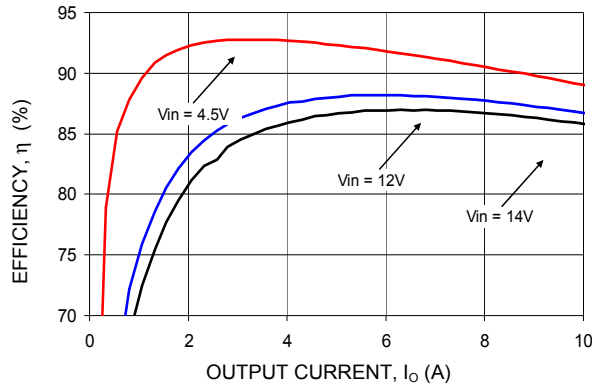

Figure 13. Converter Efficiency versus Output Current.

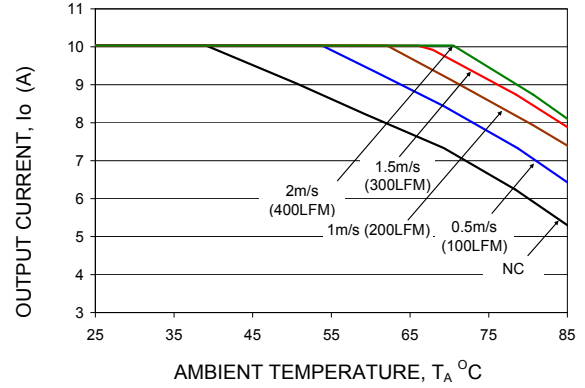

Figure 14. Derating Output Current versus Ambient Temperature and Airflow.

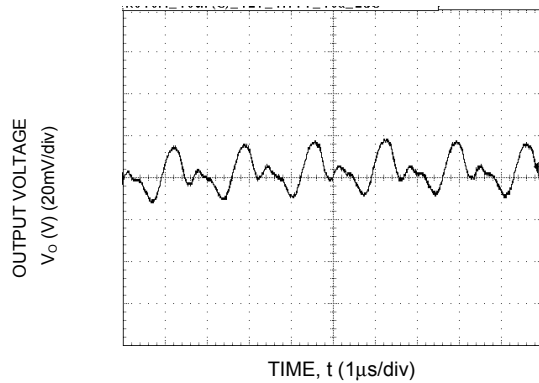

Figure 15. Typical output ripple and noise ( $V_{IN} = 12V$ ,  $I_o = I_{o,max}$ ).

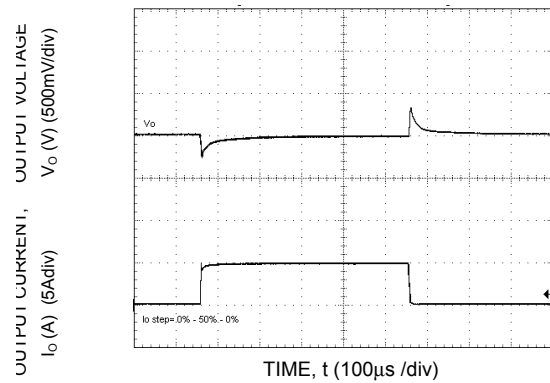

Figure 16. Transient Response to Dynamic Load Change from 0% to 50% to 0% with  $V_{IN}=12V$ .

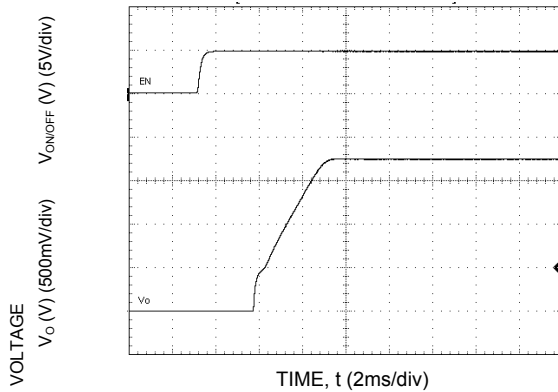

Figure 17. Typical Start-up Using On/Off Voltage ( $I_o = I_{o,max}$ ).

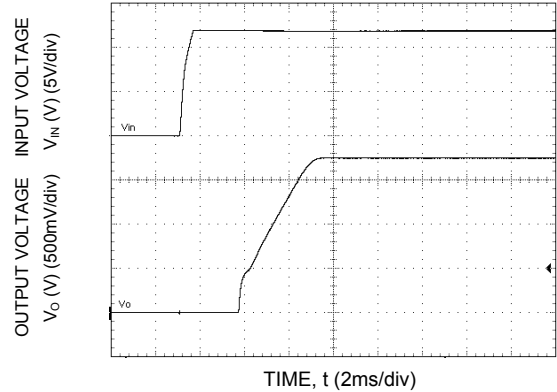

Figure 18. Typical Start-up Using Input Voltage ( $V_{IN} = 12V$ ,  $I_o = I_{o,max}$ ).



### Characteristic Curves (continued)

The following figures provide typical characteristics for the NQR010 module at 2.5V<sub>out</sub> and at 25°C.

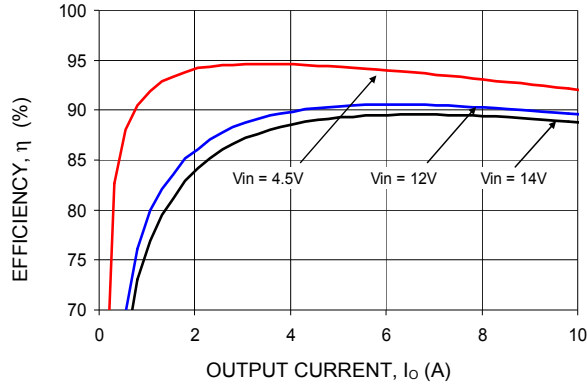

Figure 19. Converter Efficiency versus Output Current.

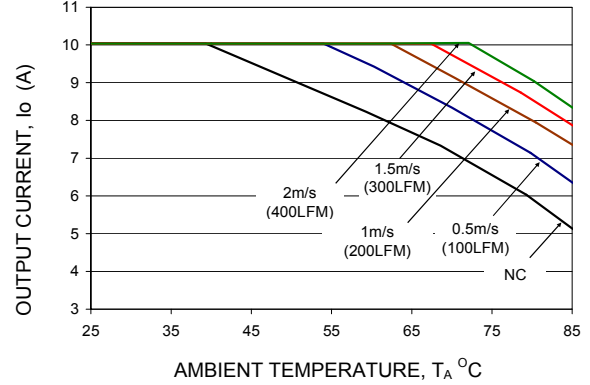

Figure 20. Derating Output Current versus Ambient Temperature and Airflow.

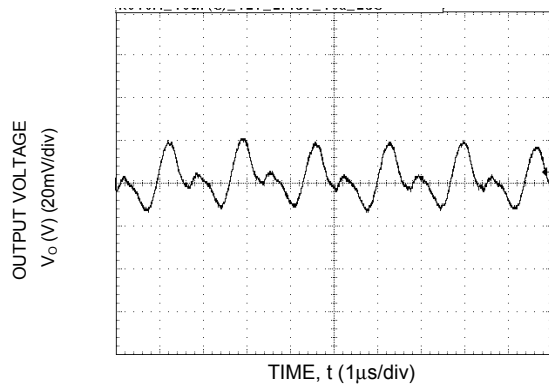

Figure 21. Typical output ripple and noise ( $V_{IN} = 12V$ ,  $I_o = I_{o,max}$ ).

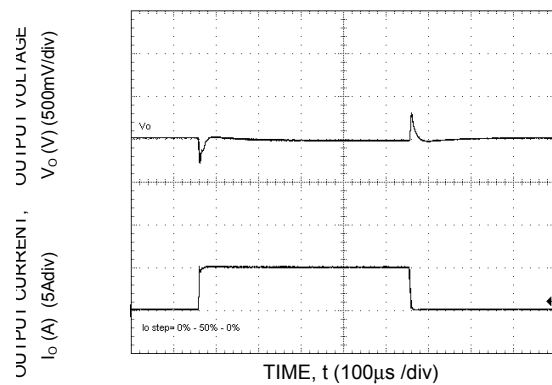

Figure 22. Transient Response to Dynamic Load Change from 0% to 50% to 0% with  $V_{IN}=12V$ .

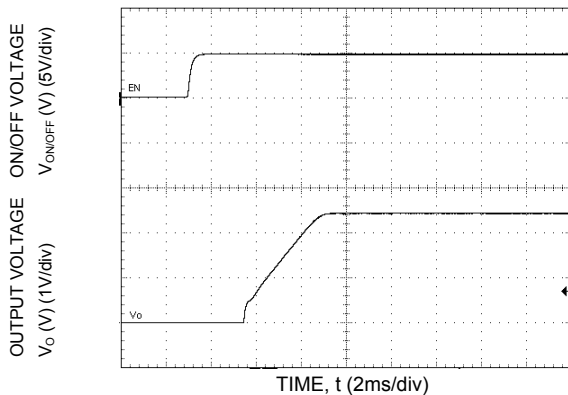

Figure 23. Typical Start-up Using On/Off Voltage ( $I_o = I_{o,max}$ ).

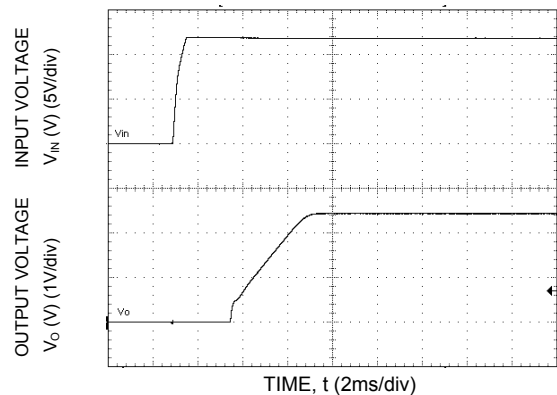

Figure 24. Typical Start-up Using Input Voltage ( $V_{IN} = 12V$ ,  $I_o = I_{o,max}$ ).

### Characteristic Curves (continued)

The following figures provide typical characteristics for the NQR010 module at 3.3V<sub>out</sub> and at 25°C.

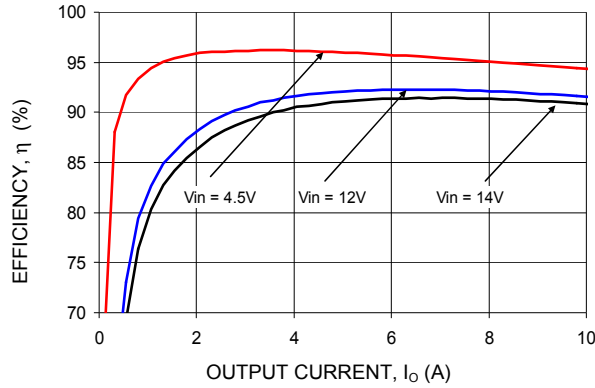

Figure 25. Converter Efficiency versus Output Current.

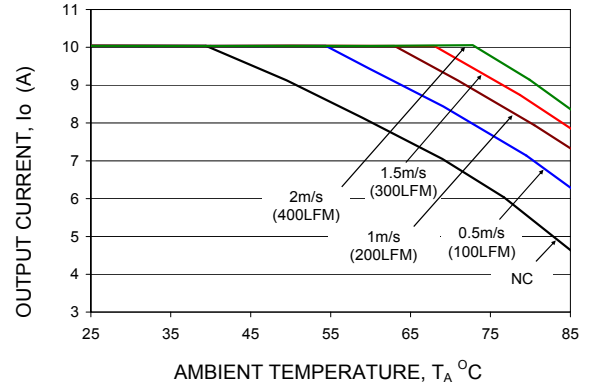

Figure 26. Derating Output Current versus Ambient Temperature and Airflow.

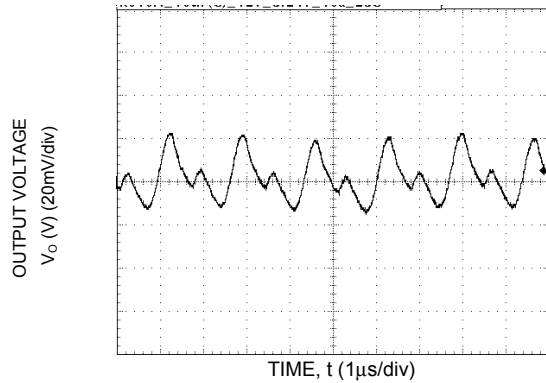

Figure 27. Typical output ripple and noise ( $V_{IN} = 12V$ ,  $I_o = I_{o,max}$ ).

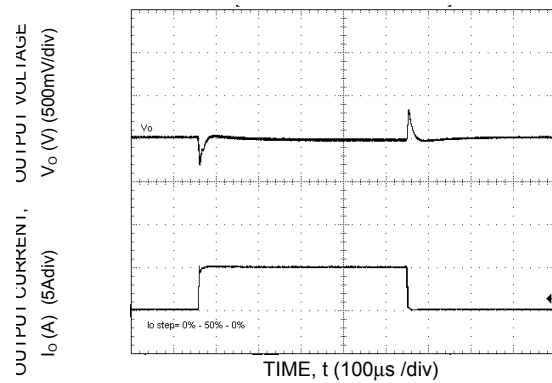

Figure 28. Transient Response to Dynamic Load Change from 0% to 50% to 0% with  $V_{IN}=12V$ .

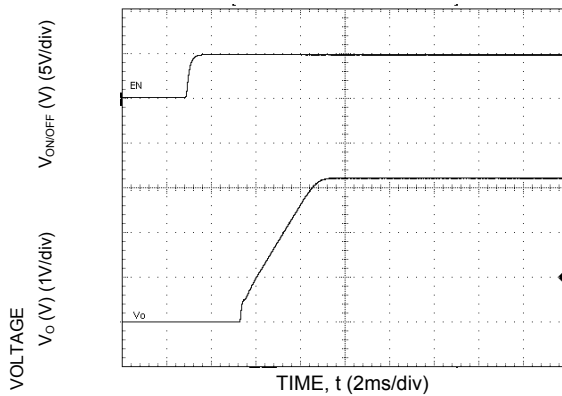

Figure 29. Typical Start-up Using On/Off Voltage ( $I_o = I_{o,max}$ ).

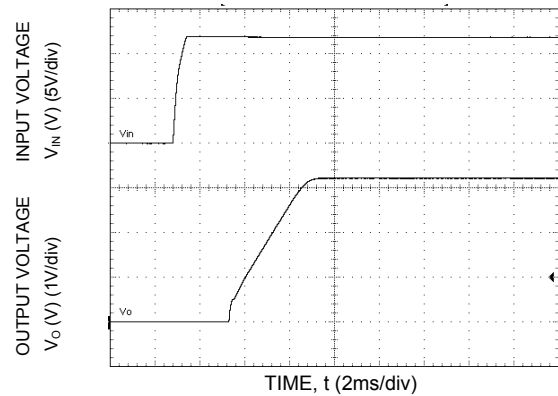

Figure 30. Typical Start-up Using Input Voltage ( $V_{IN} = 12V$ ,  $I_o = I_{o,max}$ ).

### Characteristic Curves (continued)

The following figures provide typical characteristics for the NQR010 module at 5V<sub>out</sub> and at 25°C.

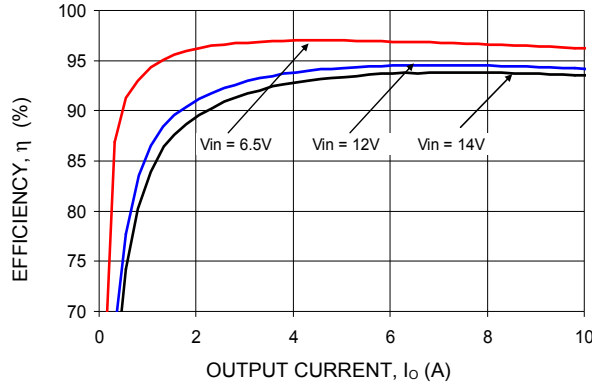

Figure 31. Converter Efficiency versus Output Current.

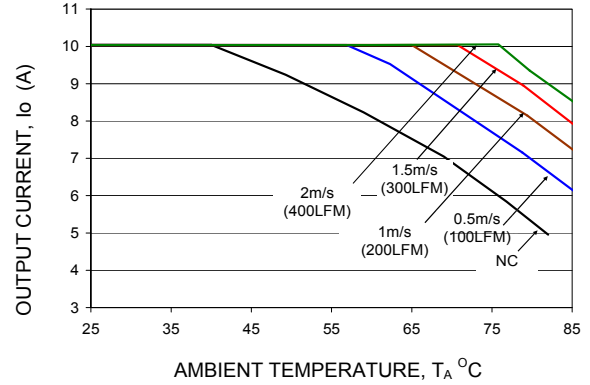

Figure 32. Derating Output Current versus Ambient Temperature and Airflow.

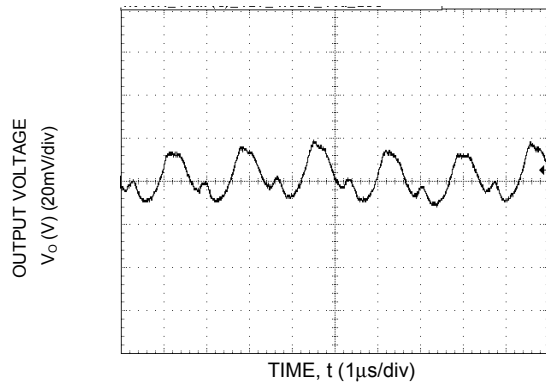

Figure 33. Typical output ripple and noise ( $V_{IN} = 12V$ ,  $I_o = I_{o,max}$ ).

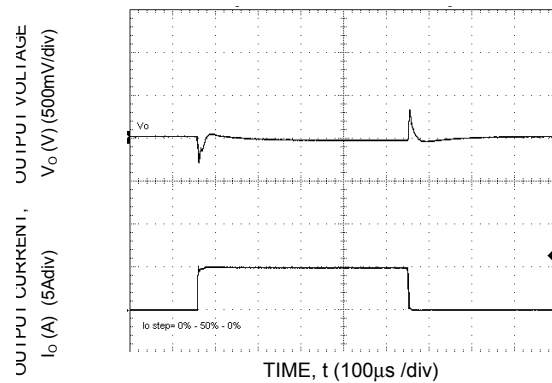

Figure 34. Transient Response to Dynamic Load Change from 0% to 50% to 0% with  $V_{IN}=12V$ .

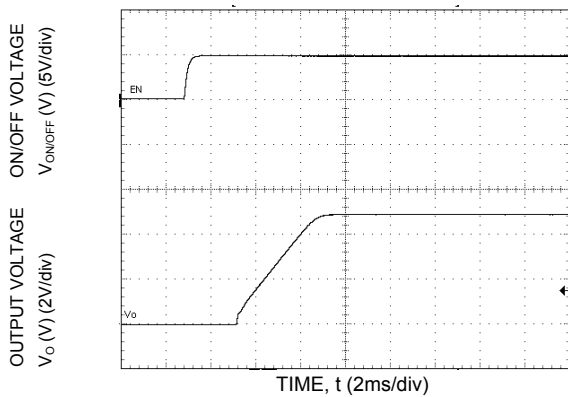

Figure 35. Typical Start-up Using On/Off Voltage ( $I_o = I_{o,max}$ ).

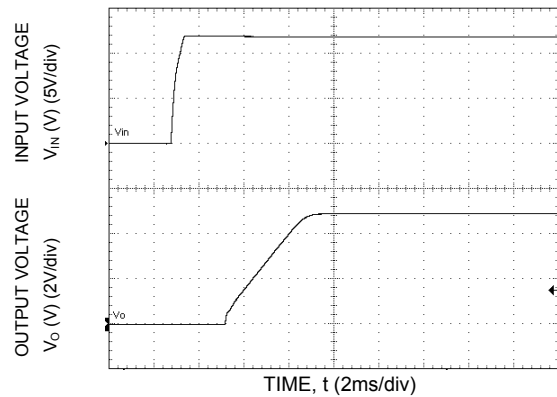

Figure 36. Typical Start-up Using Input Voltage ( $V_{IN} = 12V$ ,  $I_o = I_{o,max}$ ).

### Characteristic Curves

The following figures provide typical characteristics for the NQR010 module at 6V<sub>out</sub> and at 25°C.

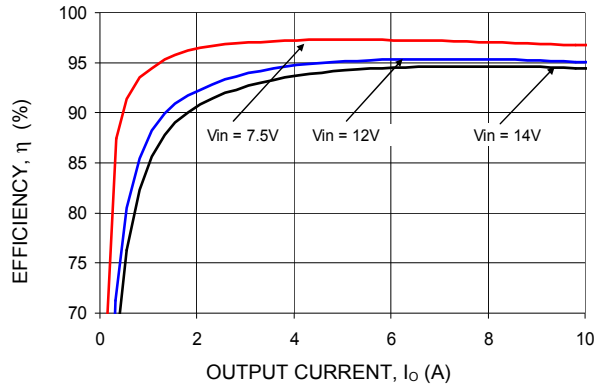

Figure 37. Converter Efficiency versus Output Current.

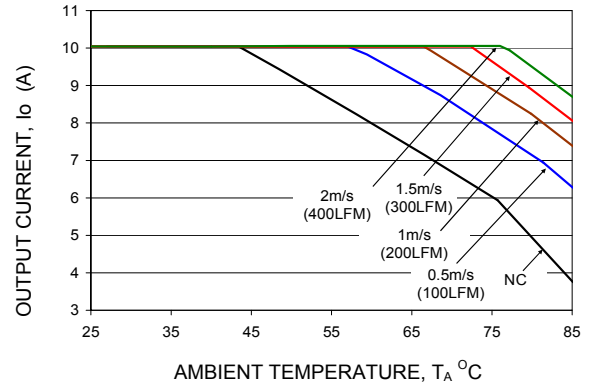

Figure 38. Derating Output Current versus Ambient Temperature and Airflow.

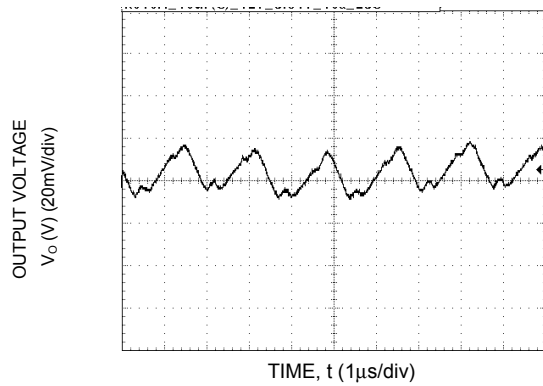

Figure 39. Typical output ripple and noise ( $V_{IN} = 12V$ ,  $I_o = I_{o,max}$ ).

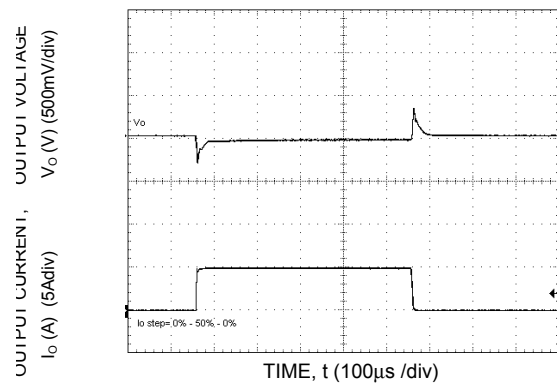

Figure 40. Transient Response to Dynamic Load Change from 0% to 50% to 0% with  $V_{IN}=12V$ .

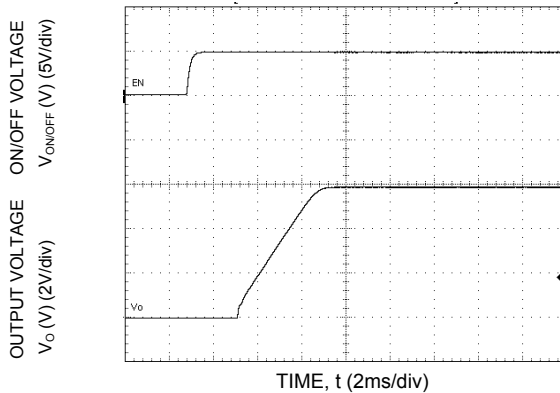

Figure 41. Typical Start-up Using On/Off Voltage ( $I_o = I_{o,max}$ ).

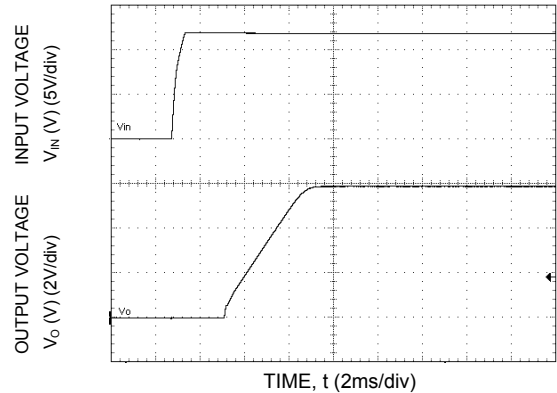
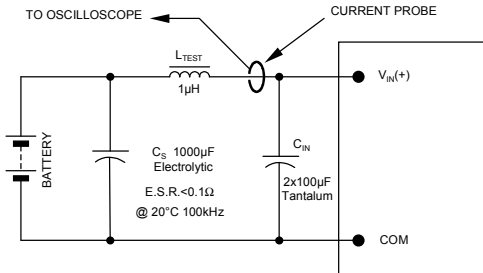

Figure 42. Typical Start-up Using Input Voltage ( $V_{IN} = 9V$ ,  $I_o = I_{o,max}$ ).

## Test Configurations



NOTE: Measure input reflected ripple current with a simulated source inductance ( $L_{TEST}$ ) of 1µH. Capacitor  $C_S$  offsets possible battery impedance. Measure current as shown above.

Figure 43. Input Reflected Ripple Current Test Setup.

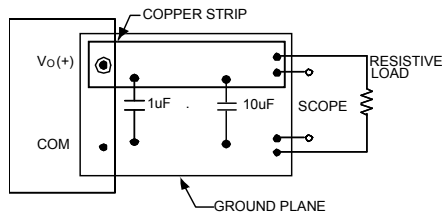

NOTE: All voltage measurements to be taken at the module terminals, as shown above. If sockets are used then Kelvin connections are required at the module terminals to avoid measurement errors due to socket contact resistance.

Figure 44. Output Ripple and Noise Test Setup.

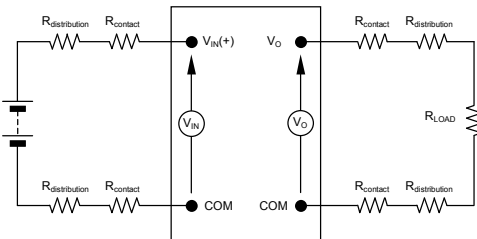

NOTE: All voltage measurements to be taken at the module terminals, as shown above. If sockets are used then Kelvin connections are required at the module terminals to avoid measurement errors due to socket contact resistance.

Figure 45. Output Voltage and Efficiency Test Setup.

$$\text{Efficiency } \eta = \frac{V_O \cdot I_O}{V_{IN} \cdot I_{IN}} \times 100 \%$$

## Design Considerations

### Input Filtering

The NQR010A0X4 10A module should be connected to a low ac-impedance source. A highly inductive source can affect the stability of the module. An input capacitance must be placed directly adjacent to the input pin of the module, to minimize input ripple voltage and ensure module stability.

To minimize input voltage ripple, low-ESR ceramic or polymer capacitors are recommended at the input of the module. Figure 46 shows the input ripple voltage for various output voltages at 10A of load current with 1x22 µF or 2x22 µF ceramic capacitors and an input of 12V.

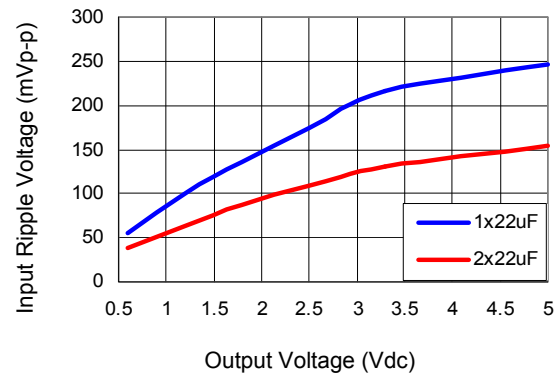

Figure 46. Input ripple voltage for various output voltages with 1x22 µF or 2x22 µF ceramic capacitors at the input (10A load). Input voltage is 12V.

### Output Filtering

The NQR010A0X4 10A modules are designed for low output ripple voltage and will meet the maximum output ripple specification with no external capacitors. However, additional output filtering may be required by the system designer for a number of reasons. First, there may be a need to further reduce the output ripple and noise of the module. Second, the dynamic response characteristics may need to be customized to a particular load step change.

To reduce the output ripple and improve the dynamic response to a step load change, additional capacitance at the output can be used. Low ESR ceramic and polymer are recommended to improve the dynamic response of the module. Figure 47 provides output ripple information for different external capacitance values at various  $V_O$  and for a load current of 10A. For stable operation of the module, limit the capacitance to less than the maximum output capacitance as specified in the electrical specification table. Optimal

performance of the module can be achieved by using the Tunable Loop™ feature described later in this data sheet.

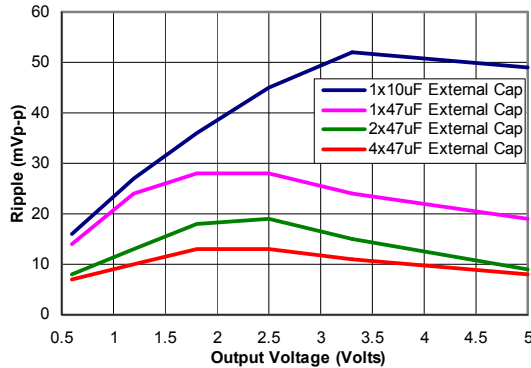

Figure 47. Output ripple voltage for various output voltages with external 1x10  $\mu$ F, 1x47  $\mu$ F, 2x47  $\mu$ F or 4x47  $\mu$ F ceramic capacitors at the output (10A load). Input voltage is 12V.

### Safety Considerations

For safety agency approval the power module must be installed in compliance with the spacing and separation requirements of the end-use safety agency standards, i.e., UL 60950-1 2nd Edition, CSA C22.2 No. 60950-1-07, and VDE 0805-1+A11:2009-11 (DIN EN60950-1 2nd Edition) Licensed.

For the converter output to be considered meeting the requirements of safety extra-low voltage (SELV), the input must meet SELV requirements. The power module has extra-low voltage (ELV) outputs when all inputs are ELV.

**A 15A quick acting input fuse for the module is required.**

### Feature Descriptions

#### Remote On/Off

The NQR010A0X4 10A power modules feature an On/Off pin with positive logic for remote On/Off operation. If the On/Off pin is not being used, leave the pin open (the module will be ON). The On/Off signal ( $V_{On/Off}$ ) is referenced to ground. During a Logic High on the On/Off pin, the module remains ON. During Logic-Low, the module is turned OFF.

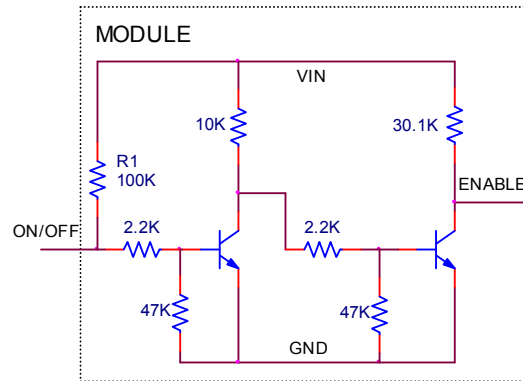

Figure 48. Remote On/Off Implementation.

#### Overcurrent Protection

To provide protection in a fault (output overload) condition, the unit is equipped with internal current-limiting circuitry and can endure current limiting continuously. At the point of current-limit inception, the unit enters hiccup mode. The unit operates normally once the output current is brought back into its specified range. The average output current during hiccup is 10%  $I_{O, max}$ .

#### Overtemperature Protection

To provide protection in a fault condition, these modules are equipped with a thermal shutdown circuit. The unit will shut down if the overtemperature threshold of 130°C is exceeded at the thermal reference point  $T_{ref}$ . The thermal shutdown is not intended as a guarantee that the unit will survive temperatures beyond its rating. Once the unit goes into thermal shutdown it will then wait to cool before attempting to restart.

#### Input Undervoltage Lockout

At input voltages below the input undervoltage lockout limit, the module operation is disabled. The module will begin to operate at an input voltage above the undervoltage lockout turn-on threshold.

## Feature Descriptions (continued)

### Output Voltage Programming

The output voltage of the NQR010A0X4 10A module can be programmed to any voltage from 0.59Vdc to 6Vdc by connecting a resistor between the Trim+ and GND pins of the module. Certain restrictions apply on the output voltage set point depending on the input voltage. These are shown in the Output Voltage vs. Input Voltage Set Point Area plot in Fig. 49. The Upper Limit curve shows that for output voltages of 0.9V and lower, the input voltage must be lower than the maximum of 14V. The Lower Limit curve shows that for output voltages of 3.3V and higher, the input voltage needs to be larger than the minimum of 4.5V.

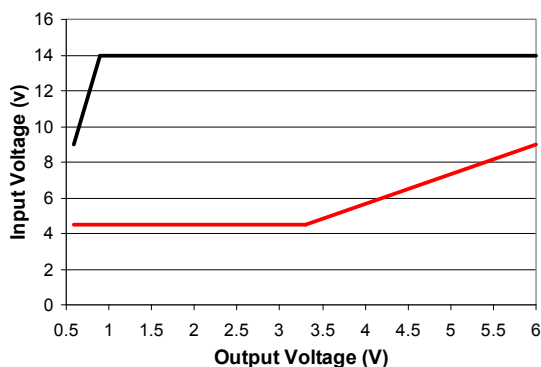

**Figure 49. Output Voltage vs. Input Voltage Set Point Area plot showing limits where the output voltage can be set for different input voltages.**

Without an external resistor between Trim+ and GND pins, the output of the module will be 0.59Vdc. To calculate the value of the trim resistor,  $R_{trim}$  for a desired output voltage, use the following equation:

$$R_{trim} = \frac{1.182}{(V_o - 0.591)} k\Omega$$

$R_{trim}$  is the external resistor in  $k\Omega$

$V_o$  is the desired output voltage

Table 1 provides  $R_{trim}$  values required for some common output voltages.

**Table 1**

$V_{O, set}$ (V)	$R_{trim}$ (K $\Omega$ )
0.59	Open
1.0	2.89
1.2	1.941
1.5	1.3
1.8	0.978
2.5	0.619
3.3	0.436
5.0	0.268
6.0	0.219

By using a  $\pm 0.5\%$  tolerance trim resistor with a TC of  $\pm 25ppm$ , a set point tolerance of  $\pm 1.5\%$  can be achieved as specified in the electrical specification. The POL Programming Tool available at [www.lineagepower.com](http://www.lineagepower.com) under the Design Tools section, helps determine the required trim resistor needed for a specific output voltage.

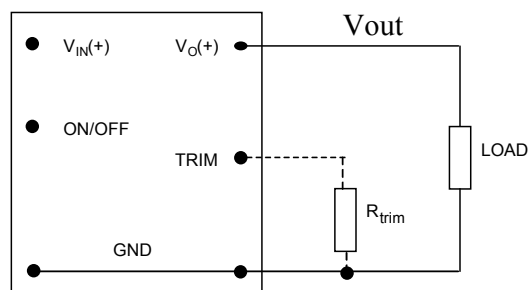

**Figure 50. Circuit configuration for programming output voltage using an external resistor.**

### Voltage Margining

Output voltage margining can be implemented in the NQR010A0X4 10A modules by connecting a resistor,  $R_{margin-up}$ , from the Trim pin to the ground pin for margining-up the output voltage and by connecting a resistor,  $R_{margin-down}$ , from the Trim pin to output pin for margining-down. Figure 51 shows the circuit configuration for output voltage margining. The POL Programming Tool, available at [www.lineagepower.com](http://www.lineagepower.com) under the Design Tools section, also calculates the values of  $R_{margin-up}$  and  $R_{margin-down}$  for a specific output voltage and % margin. Please consult your local Lineage Power Field Application Engineer or Account Manager for additional details.

### Feature Descriptions (continued)

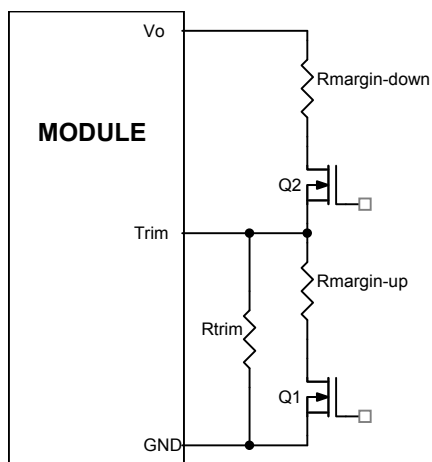

Figure 51. Circuit Configuration for margining Output voltage.

### Monotonic Start-up and Shutdown

The NQR010A0X4 10A modules have monotonic start-up and shutdown behavior for any combination of rated input voltage, output current and operating temperature range.

### Tunable Loop™

The NQR010A0X4 10A modules have a new feature that optimizes transient response of the module called Tunable Loop™. External capacitors are usually added to improve output voltage transient response due to load current changes. Sensitive loads may also require additional output capacitance to reduce output ripple and noise. Adding external capacitance however affects the voltage control loop of the module, typically causing the loop to slow down with sluggish response. Larger values of external capacitance could also cause the module to become unstable.

To use the additional external capacitors in an optimal manner, the Tunable Loop™ feature allows the loop to be tuned externally by connecting a series R-C between the VOUT and TRIM pins of the module, as shown in Fig. 52. This R-C allows the user to externally adjust the voltage loop feedback compensation of the module to match the filter network connected to the output of the module.

Recommended values of  $R_{TUNE}$  and  $C_{TUNE}$  are given in Tables 2 and 3. Table 2 lists recommended values of  $R_{TUNE}$  and  $C_{TUNE}$  in order to meet 2% output voltage deviation limits for some common output voltages in the presence of a 5A to 10A step change (50% of full load),

with an input voltage of 12V. Table 3 shows the recommended values of  $R_{TUNE}$  and  $C_{TUNE}$  for different values of ceramic output capacitors up to 1000uF, again for an input voltage of 12V. The value of  $R_{TUNE}$  should never be lower than the values shown in Tables 2 and 3. Please contact your Lineage Power technical representative to obtain more details of this feature as well as for guidelines on how to select the right value of external R-C to tune the module for best transient performance and stable operation for other output capacitance values.

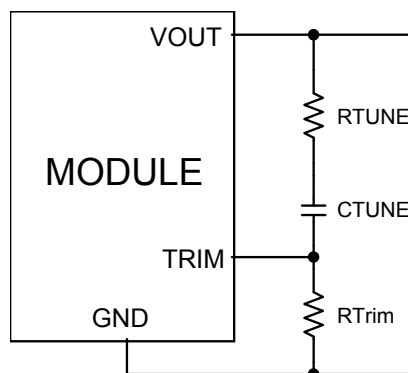

Figure 52. Circuit diagram showing connection of  $R_{TUNE}$  and  $C_{TUNE}$  to tune the control loop of the module.

Table 2. Recommended values of  $R_{TUNE}$  and  $C_{TUNE}$  to obtain transient deviation of 2% of  $V_{out}$  for a 5A step load with  $V_{in}=12V$ .

Vout	5V	3.3V	2.5V	1.8V	1.2V	0.6V
$C_{ext}$	4x47 $\mu$ F	330 $\mu$ F Polymer	330 $\mu$ F Polymer	2x330 $\mu$ F Polymer	3x330 $\mu$ F Polymer	9x330 $\mu$ F Polymer
$R_{TUNE}$	47	47	47	47	47	30
$C_{TUNE}$	39nF	100nF	100nF	220nF	220nF	330nF
$\Delta V$	76mV	39mV	39mV	25mV	22mV	12mV

Table 3. General recommended values of  $R_{TUNE}$  and  $C_{TUNE}$  for  $V_{in}=12V$  and various external ceramic capacitor combinations.

$C_{ext}$	1x47 $\mu$ F	2x47 $\mu$ F	4x47 $\mu$ F	6x47 $\mu$ F	10x47 $\mu$ F	20x47 $\mu$ F
$R_{TUNE}$	100	75	47	47	47	47
$C_{TUNE}$	12nF	22nF	39nF	56n	68nF	100nF



## Thermal Considerations

Power modules operate in a variety of thermal environments; however, sufficient cooling should be provided to help ensure reliable operation.

Considerations include ambient temperature, airflow, module power dissipation, and the need for increased reliability. A reduction in the operating temperature of the module will result in an increase in reliability. The thermal data presented here is based on physical measurements taken in a wind tunnel. The test set-up is shown in Figure 53. The preferred airflow direction for the module is in Figure 54.

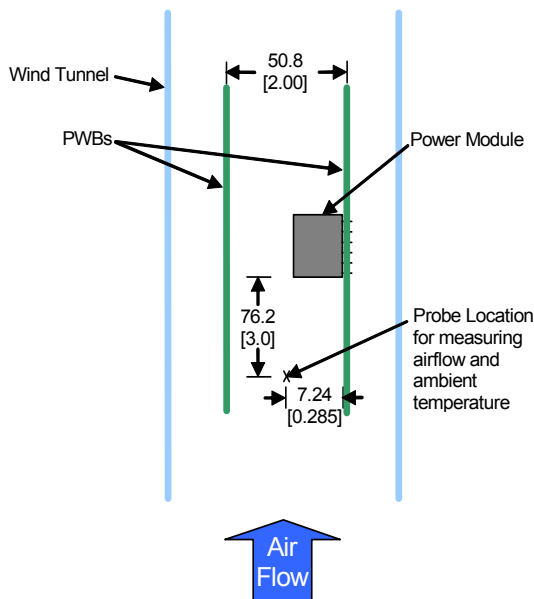

Figure 53. Thermal Test Set-up.

The thermal reference point,  $T_{ref}$  used in the specifications of thermal derating curves is shown in Figure 54. For reliable operation this temperature should not exceed 125°C.

The output power of the module should not exceed the rated power of the module ( $V_{o,set} \times I_{o,max}$ ).

Please refer to the Application Note “Thermal Characterization Process For Open-Frame Board-Mounted Power Modules” for a detailed discussion of thermal aspects including maximum device temperatures.

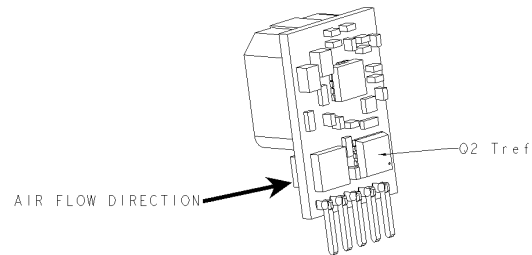

Figure 54.  $T_{ref}$  Temperature measurement location.

## Post solder Cleaning and Drying Considerations

Post solder cleaning is usually the final circuit-board assembly process prior to electrical board testing. The result of inadequate cleaning and drying can affect both the reliability of a power module and the testability of the finished circuit-board assembly. For guidance on appropriate soldering, cleaning and drying procedures, refer to *Board Mounted Power Modules: Soldering and Cleaning Application Note*.

## Through-Hole Lead-Free Soldering Information

These RoHS-compliant through-hole products use the SAC (Sn/Ag/Cu) Pb-free solder and RoHS-compliant components. They are designed to be processed through single or dual wave soldering machines. The pins have an RoHS-compliant finish that is compatible with both Pb and Pb-free wave soldering processes. A maximum preheat rate of 3°C/s is suggested. The wave preheat process should be such that the temperature of the power module board is kept below 210°C. For Pb solder, the recommended pot temperature is 260°C, while the Pb-free solder pot is 270°C max. Not all RoHS-compliant through-hole products can be processed with paste-through-hole Pb or Pb-free reflow process. If additional information is needed, please consult with your Lineage Power representative for more details.

**Mechanical Outline**

Dimensions are in millimeters and (inches).

Tolerances: x.x mm ± 0.5 mm (x.xx in. ± 0.02 in.) [unless otherwise indicated]  
 x.xx mm ± 0.25 mm (x.xxx in. ± 0.010 in.)

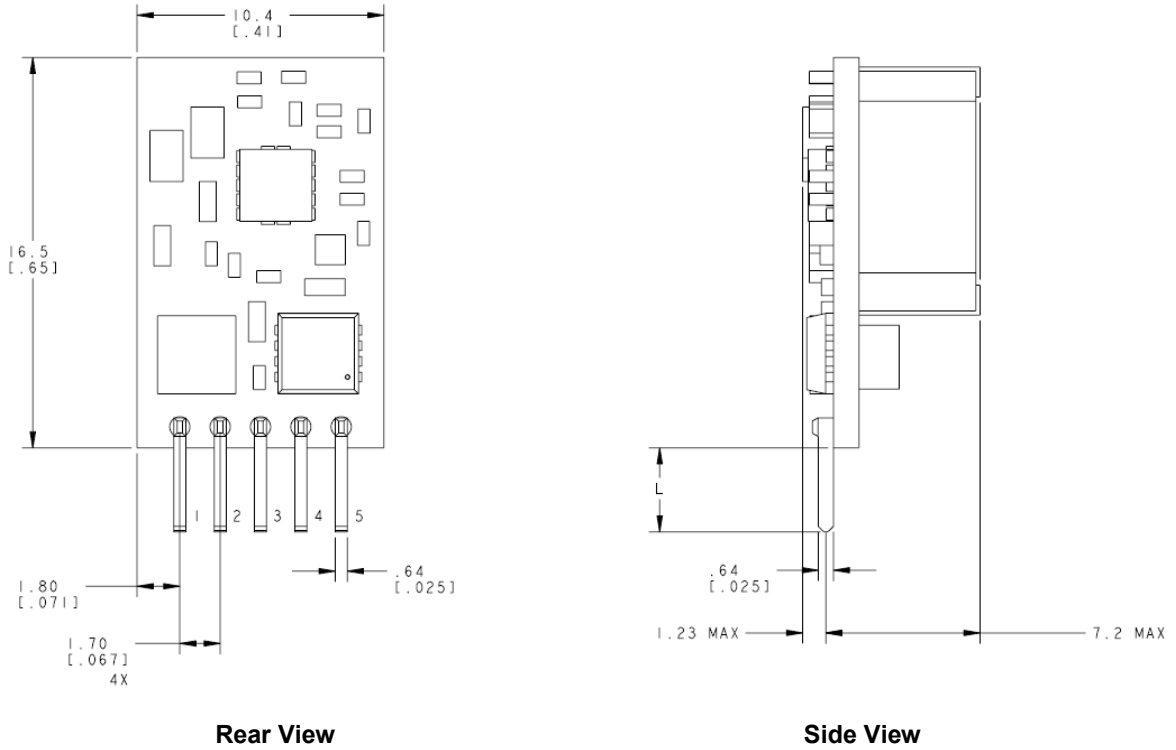

L = 3.29 [0.13] - " " (STD)  
 2.85 ± 0.25 [0.112 ± 0.01] - "-62"  
 5.08 [0.20] - "54"

**Pin out**

Pin	Function
1	On/Off
2	V <sub>IN</sub>
3	GND
4	V <sub>out</sub>
5	Trim+

### Recommended Pad Layout

Dimensions are in millimeters and (inches).

Tolerances: x.x mm  $\pm$  0.5 mm (x.xx in.  $\pm$  0.02 in.) [unless otherwise indicated]

x.xx mm  $\pm$  0.25 mm (x.xxx in  $\pm$  0.010 in.)

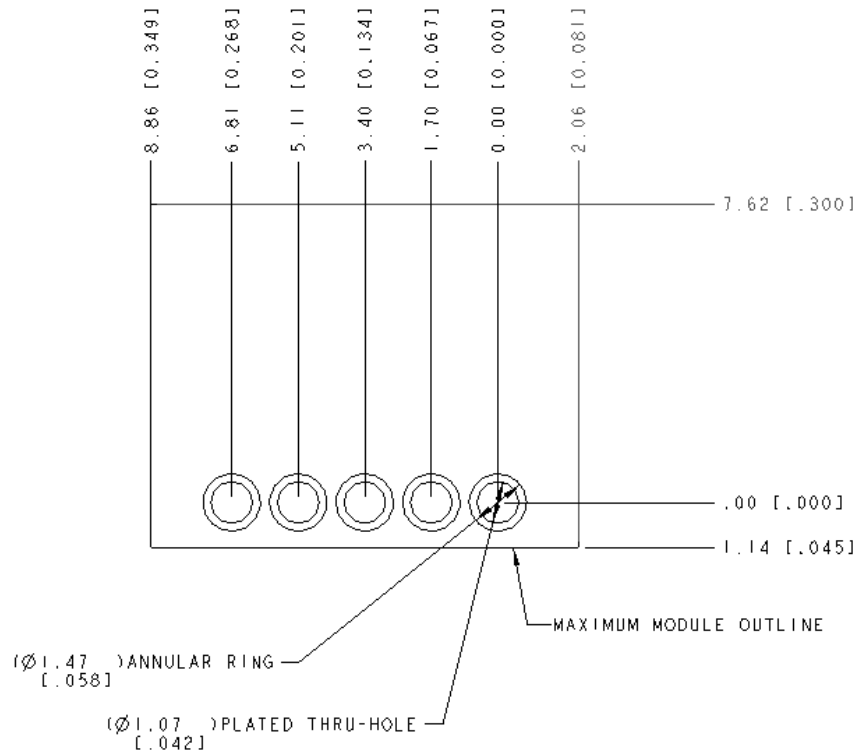

## Ordering Information

Please contact your Lineage Power Sales Representative for pricing, availability and optional features.

**Table 4. Device Codes**

Device Code	Input Voltage Range	Output Voltage	Output Current	On/Off Logic	Connector Type	Comcodes
NQR010A0X4Z	4.5 – 14Vdc	0.59 – 6Vdc	10A	Positive	SIP	CC109153012
NQR010A0X54Z	4.5 – 14Vdc	0.59 – 6Vdc	10A	Positive	SIP	CC109160090

X4 refers to pin length of 3.29mm  
X54 refers to pin length of 5.08mm  
Z refers to RoHS-compliant versions



**LINEAGE POWER**<sup>®</sup>

**World Wide Headquarters**  
**Lineage Power Corporation**  
601 Shiloh Road, Plano, TX 75074, USA  
**+1-888-LINEAGE(546-3243)**  
(Outside U.S.A.: **+1-972-244-WATT(9288)**)  
**www.lineagepower.com**  
**e-mail: techsupport1@lineagepower.com**

**Asia-Pacific Headquarters**  
Tel: +86.021.54279977\*808

**Europe, Middle-East and Africa Headquarters**  
Tel: +49.89.878067-280

**India Headquarters**  
Tel: +91.80.28411633

Lineage Power reserves the right to make changes to the product(s) or information contained herein without notice. No liability is assumed as a result of their use or application. No rights under any patent accompany the sale of any such product(s) or information.

Lineage Power DC-DC products are protected under various patents. Information on these patents is available at [www.lineagepower.com/patents](http://www.lineagepower.com/patents).

© 2011 Lineage Power Corporation, (Plano, Texas) All International Rights Reserved.