

QSDW035A0B Barracuda Series* Power Modules; DC-DC Converters

36Vdc –75Vdc Input; 12Vdc Output; 35A Output Current



RoHS Compliant

Applications

- Distributed power architectures
- Intermediate bus voltage applications
- Servers and storage applications
- Networking equipment including Power over Ethernet (PoE)
- Fan assemblies other systems requiring a tightly regulated output voltage

Options

- Negative Remote On/Off logic (1=option code, factory preferred)
- Auto-restart after fault shutdown (4=option code, factory preferred)
- Base plate option (-H=option code)
- Passive Droop Load Sharing (-P=option code)
- Higher Output Capacitance (-Q=option code)

Description

The QSDW035A0B series of dc-dc converters are a new generation of DC/DC power modules designed to support 9.6 -12V_{dc} intermediate bus applications where multiple low voltages are subsequently generated using point of load (POL) converters, as well as other application requiring a tightly regulated output voltage. The QSDW035A0B series operate from an input voltage range of 36 to 75V_{dc}, and provide up to 35A output current at output voltages from 5.0V_{dc} to 12.0V_{dc}. The 12V output is well regulated for the entire input voltage range. The QSDW035A0B has improved line transient performance as compared to earlier generation modules. The converter incorporates digital control, synchronous rectification technology, and innovative packaging techniques to achieve efficiency reaching 96% peak at 12V_{dc} output. This leads to lower power dissipation, such that, for many applications a heat sink is not required. Standard features include output voltage trim, remote sense, on/off control, output overcurrent and over voltage protection, over temperature protection, input under and over voltage lockout, power good signal and PMBus interface.

The output is fully isolated from the input, allowing versatile polarity configurations and grounding connections. Built-in filtering for both input and output minimizes the need for external filtering.

Features

- Compliant to RoHS EU Directive 2011/65/EU (-Z versions)
- Compliant to REACH Directive (EC) No 1907/2006
- Compatible with reflow pin/paste soldering process
- High efficiency – 95.5% at 12V_{dc}, 50% load to 100% load
- Wide Input voltage range: 36-75V_{dc}
- Delivers up to 35A_{dc} output current
- Output Voltage adjust: 5.0V_{dc} to 13.2V_{dc}
- Tightly regulated output voltage
- Low output ripple and noise
- Industry standard, DOSA compliant, Quarter brick: 58.4mm x 36.8 mm x 10.7 mm (2.30in x 1.45 in x 0.42 in)
- Constant switching frequency
- Digital interface with PMBus™ Rev.1.2 compliance
- Positive Remote On/Off logic
- Output over current/voltage protection
- Over temperature protection
- Wide operating temperature range (-40°C to 85°C)
 - UL* 60950-1, 2nd Ed. Recognized, CSA† C22.2 No. 60950-1-07 Certified, and VDE‡ (EN60950-1, 2nd Ed.) Licensed
- CE mark 2006/96/EC directives§
- Meets the voltage and current requirements for ETSI 300-132-2 and complies with and licensed for Basic insulation rating per EN60950-1
- 2250 Vdc isolation tested in compliance with IEEE 802.3⌘ PoE standards
- ISO** 9001 and ISO14001 certified manufacturing facilities

* Trademark of General Electric Company

UL is a registered trademark of Underwriters Laboratories, Inc.

† CSA is a registered trademark of Canadian Standards Association.

‡ VDE is a trademark of Verband Deutscher Elektrotechniker e.V.

§ This product is intended for integration into end-user equipment. All of the required procedures of end-use equipment should be followed.

⌘ IEEE and 802 are registered trademarks of the Institute of Electrical and Electronics Engineers, Incorporated.

** ISO is a registered trademark of the International Organization of Standards.

QSDW035A0B Series Power Modules; DC-DC Converters

36Vdc –75Vdc Input; 12Vdc Output; 35A Output Current

Absolute Maximum Ratings

Stresses in excess of the absolute maximum ratings can cause permanent damage to the device. These are absolute stress ratings only, functional operation of the device is not implied at these or any other conditions in excess of those given in the operations sections of the Data Sheet. Exposure to absolute maximum ratings for extended periods can adversely affect device reliability.

Parameter	Device	Symbol	Min	Max	Unit
Input Voltage*					
Continuous		V_{IN}	-0.3	75	V _{dc}
Operating transient $\leq 100\text{mS}$				100	V _{dc}
Operating Input transient slew rate, $50V_{IN}$ to $75V_{IN}$ (Output may exceed regulation limits, no protective shutdowns shall activate, $C_0=220\mu\text{F}$ to $C_{0,max}$)		-	-	5	V/ μs
Non-operating continuous		V_{IN}	80	100	V _{dc}
Operating Ambient Temperature (See Thermal Considerations section)	All	T_A	-40	85	°C
Storage Temperature	All	T_{stg}	-55	125	°C
I/O Isolation Voltage (100% factory Hi-Pot tested)	All	—	—	2250	V _{dc}

* Input over voltage protection will shut down the output voltage when the input voltage exceeds threshold level.

Electrical Specifications

Unless otherwise indicated, specifications apply over all operating input voltage, resistive load, and temperature conditions.

Parameter	Device	Symbol	Min	Typ	Max	Unit
Operating Input Voltage		V_{IN}	36	48	75	V _{dc}
Maximum Input Current ($V_{IN}=0\text{V}$ to 75V , $I_0=I_{0,max}$)		$I_{IN,max}$	-	-	13.5	A _{dc}
Input No Load Current ($V_{IN} = V_{IN,nom}$, $I_0 = 0$, module enabled)	All	$I_{IN,No\ load}$		87		mA
Input Stand-by Current ($V_{IN} = V_{IN,nom}$, module disabled)	All	$I_{IN,stand-by}$			30	mA
External Input Capacitance	All		100	-	-	μF
Inrush Transient	All	I^2t	-	-	1	A ² s
Input Terminal Ripple Current (Measured at module input pin with maximum specified input capacitance and < 500uH inductance between voltage source and input capacitance $C_{IN}=220\mu\text{F}$, 5Hz to 20MHz, $V_{IN}=48\text{V}$, $I_0=I_{0,max}$)	All		-	450	-	mA _{rms}
Input Reflected Ripple Current, peak-to-peak (5Hz to 20MHz, 12 μH source impedance; $V_{IN}=48\text{V}$, $I_0=I_{0,max}$; see Figure 11)	All		-	50	-	mA _{p-p}
Input Ripple Rejection (120Hz)	All		-	50	-	dB

CAUTION: This power module is not internally fused. An input line fuse must always be used.

This power module can be used in a wide variety of applications, ranging from simple standalone operation to an integrated part of sophisticated power architecture. To preserve maximum flexibility, internal fusing is not included, however, to achieve maximum safety and system protection, always use an input line fuse. The safety agencies require a fast-acting fuse with a maximum rating of 25A (see Safety Considerations section). Based on the information provided in this Data Sheet on inrush energy and maximum dc input current, the same type of fuse with a lower rating can be used. Refer to the fuse manufacturer's Data Sheet for further information.

QSDW035A0B Series Power Modules; DC-DC Converters

36Vdc –75Vdc Input; 12Vdc Output; 35A Output Current

Electrical Specifications (continued)

Unless otherwise indicated, specifications apply over all operating input voltage, resistive load, and temperature conditions.

Parameter	Device	Symbol	Min	Typ	Max	Unit
Output Voltage Set-point (Default) ($V_{IN}=V_{IN,nom}$, $I_O=17.5A$, $T_A=25^\circ C$) (Adjustable via PMBus)	All	$V_{O,set}$	11.97	12.00	12.03	V _{dc}
Output Voltage (Over all operating input voltage, resistive load, and temperature conditions until end of life)	All w/o -P -P Option	V_O V_O	11.76 11.63	— —	12.24 12.37	V _{dc} V _{dc}
Output Regulation						
Line	All w/o -P		—	0.2	—	% $V_{O,set}$
Load	All w/o -P		—	0.2	—	% $V_{O,set}$
Line	-P Option		—	0.5	—	% $V_{O,set}$
Load, Intentional Droop	-P Option			0.50		V _{dc}
Temperature ($T_A = -40^\circ C$ to $+85^\circ C$)	All		—	2	—	% $V_{O,set}$
Output Ripple and Noise on nominal output ($V_{IN}=V_{IN,nom}$ and $I_O=I_{O,min}$ to $I_{O,max}$, tested with a 1.0 μF ceramic, 10 μF aluminum and 220 μF polymer capacitor across the load.)						
RMS (5Hz to 20MHz bandwidth)	All		—	70	—	mV _{rms}
Peak-to-Peak (5Hz to 20MHz bandwidth)	All		—	200	—	mV _{pk-pk}
External Output Capacitance (For $C_O > 5000\mu F$, I_O must be $< 50\% I_{O,max}$ during Trise)	All except -Q -Q Option	C_O	220 6000	— —	10,000 15,000	μF
Output Current	All	I_O	0		35	A _{dc}
VOUT_OC_FAULT_LIMIT (Default) (Adjustable via PMBus)	All	$I_{O,lim}$	—	42	—	A _{dc}
Efficiency ($V_{IN}=V_{IN,nom}$, $V_O=V_{O,set}$, $T_A=25^\circ C$)						
$I_O=100\% I_{O,max}$	All	η		95.5		%
$I_O=55\% - 90\% I_{O,max}$	All	η		95.7		%
Switching Frequency (primary MOSFETs) (Output Ripple 2X switching frequency)		f_{sw}		150		kHz
Dynamic Load Response ($dI_O/dt=1A/10\mu s$; $V_{IN}=V_{IN,nom}$; $T_A=25^\circ C$; tested with a 10 μF ceramic and 470 μF polymer capacitor across the load.)						
Load Change from $I_O=50\%$ to 75% of $I_{O,max}$: Peak Deviation	All	V_{pk}	—	750	—	mV _{pk}
Settling Time ($V_O < 10\%$ peak deviation)		t_s	—	800	—	μs
Load Change from $I_O=75\%$ to 50% of $I_{O,max}$: Peak Deviation		V_{pk}	—	750	—	mV _{pk}
Settling Time ($V_O < 10\%$ peak deviation)		t_s	—	800	—	μs

General Specifications

Parameter	Device	Symbol	Typ	Unit
Calculated Reliability Based upon Telcordia SR-332 Issue 3: Method I, Case 3, ($I_O=80\% I_{O,max}$, $T_A=40^\circ C$, Airflow = 200 LFM), 90% confidence	All	MTBF	11,117,223	Hours
	All	FIT	90.0	10^9 /Hours
Weight - Open Frame			49.6 (1.75)	g (oz.)
Weight - with Base plate option			69.2 (2.44)	g (oz.)

Isolation Specifications

Parameter	Symbol	Min	Typ	Max	Unit
Isolation Capacitance	C_{iso}	—	2000	—	pF
Isolation Resistance	R_{iso}	10	—	—	M Ω

QSDW035A0B Series Power Modules; DC-DC Converters

36Vdc –75Vdc Input; 12Vdc Output; 35A Output Current

Feature Specifications

Unless otherwise indicated, specifications apply over all operating input voltage, resistive load, and temperature conditions. See Feature Descriptions for additional information.

Parameter	Device	Symbol	Min	Typ	Max	Unit
Remote On/Off Signal Interface ($V_{IN}=V_{IN, min}$ to $V_{IN, max}$, Signal referenced to V_{IN-} terminal) Negative Logic: device code suffix "1" Logic Low = module On, Logic High = module Off Positive Logic: No device code suffix required Logic Low = module Off, Logic High = module On Logic Low Specification On/Off Thresholds:						
Remote On/Off Current – Logic Low	All	$I_{on/off}$	280	—	310	μA
Logic Low Voltage	All	$V_{on/off}$	-0.3	—	0.8	V _{dc}
Logic High Voltage – (Typ = Open Collector)	All	$V_{on/off}$	2.0	—	14.5	V _{dc}
Logic High maximum allowable leakage current ($V_{on/off} = 2.0V$)	All	$I_{on/off}$	—	—	10	μA
Maximum voltage allowed on On/Off pin	All	$V_{on/off}$	—	—	14.5	V _{dc}
Turn-on Delay and Rise Time ($I_o=I_{o, max}$, Adjustable via PMBus)						
T_{delay} =Time until $V_o = 10\%$ of $V_{o, set}$ from either application of V_{in} with Remote On/Off set to On (Enable with V_{in}); or operation of Remote On/Off from Off to On with V_{in} already applied for at least 150 milliseconds (Enable with on/off). * Increased T_{delay} due to startup for parallel modules.	All w/o -P	$T_{delay, Enable with V_{in}}$	—	—	150	ms
	All w/o -P	$T_{delay, Enable with on/off}$	—	—	10	ms
	w/ -P	$T_{delay, Enable with V_{in}}$	—	—	180*	ms
	w/ -P	$T_{delay, Enable with on/off}$	—	—	40*	ms
T_{rise} =Time for V_o to rise from 10% to 90% of $V_{o, set}$, For $C_o > 5000\mu F$, I_o must be $< 50\%$ $I_{o, max}$ during T_{rise} . * Increased T_{rise} when V_o exists at startup for parallel modules.	All w/o -P	T_{rise}	—	—	25	ms
	w/ -P	T_{rise}	—	—	50*	ms
Load Sharing Current Balance (difference in output current across all modules with outputs in parallel, no load to full load)	-P Option	I_{diff}			3	A
Remote Sense Range	All	V_{sense}	—	—	0.5	V _{dc}
Output Voltage Adjustment range (Adjustable via PMBus)	All	$V_{o, set}$	5.0		13.2	V _{dc}
Output Overvoltage Protection Setpoint (Adjustable via PMBus)	All	$V_{o, OVPset}$	$V_{o, SET}+0.001V$	—	$V_{o, SET}+3.99V$	V _{dc}
Output Voltage Peak Limits prior to OVP Protection, (100%-0% load dump, $C_o=C_{o, min}$ all V_{IN} , I_o) ($5.0V \leq V_{o, SET} \leq 12.0V$) ($12.01V \leq V_{o, SET} \leq 13.2V$)	All	$V_{o, limit}$	$V_{o, OVPset}-0.5V$	—	$V_{o, OVPset} + 2.0V$	V _{dc}
	All	$V_{o, limit}$	15.49	—	17.99V	V _{dc}
Overtemperature Protection (See Feature Descriptions)	All	T_{ref}	—	135	—	°C
Input Undervoltage Lockout (Adjustable via PMBus)						
Turn-on Threshold			—	35	36	V _{dc}
Turn-off Threshold			31	33	—	V _{dc}
Input Overvoltage Lockout						
Turn-off Threshold			—	85	—	V _{dc}
Turn-on Threshold			—	80	—	V _{dc}
Pull down resistance of PGOOD pin Sink current capability into PGOOD pin ($V_{PG}=2.2V$)	All				150	Ω
	All				15	mA

QSDW035A0B Series Power Modules; DC-DC Converters

36Vdc – 75Vdc Input; 12Vdc Output; 35A Output Current

Digital Interface Specifications

Unless otherwise indicated, specifications apply over all operating input voltage, resistive load, and temperature conditions. See Feature Descriptions for additional information.

Parameter	Conditions	Symbol	Min	Typ	Max	Unit
PMBus Signal Interface Characteristics						
Input High Voltage (CLK, DATA)		V _{IH}	2.1		3.6	V
Input Low Voltage (CLK, DATA)		V _{IL}			0.8	V
Input high level current (CLK, DATA)		I _{IH}	-10		10	μA
Input low level current (CLK, DATA)		I _{IL}	-10		10	μA
Output Low Voltage (CLK, DATA, SMBALERT#)	I _{OUT} =2mA	V _{OL}			0.4	V
Output high level open drain leakage current (DATA, SMBALERT#)	V _{OUT} =3.6V	I _{OH}	0		10	μA
Pin capacitance		C _O		0.7		pF
PMBus Operating frequency range (* 5-10 kHz to accommodate hosts not supporting clock stretching)	Slave Mode	FPMB	5*		400	kHz
Measurement System Characteristics						
Output current reading range		I _{OUT(RNG)}	1.6500		63.937	A
Output current reading blanking		I _{OUT(BNK)}	0		1.5875	A
Output current reading resolution		I _{OUT(RES)}		62.5		mA
Output current reading accuracy (V _{in} = 48V, V _{out} = 12V)	17.5A < I _{out} < 35.0A	I _{OUT(ACC)}	-6.0		6.0	%
Output current reading accuracy (absolute difference between actual and reported values)	1.75A < I _{out} < 17.5A	I _{OUT(ACC)}	-2		2	A
V _{OUT} reading range		V _{OUT(RNG)}	0		15.9997	V
V _{OUT} reading resolution		V _{OUT(RES)}		0.244		mV
V _{OUT} reading accuracy		V _{OUT(ACC)}	-2.0	0.6	2.0	%
V _{IN} reading range		V _{IN(RNG)}	0		127.875	V
V _{IN} reading resolution		V _{IN(RES)}		125		mV
V _{IN} reading accuracy		V _{IN(ACC)}	-4.0	0.8	4.0	%
Temperature reading resolution		T _(RES)		0.25		°C
Temperature reading accuracy		T _(ACC)	-5.0		5.0	%

QSDW035A0B Series Power Modules; DC-DC Converters

36Vdc – 75Vdc Input; 12Vdc Output; 35A Output Current

Characteristic Curves

The following figures provide typical characteristics for the QSVW035A0B (12V, 35A) at 25°C. The figures are identical for either positive or negative Remote On/Off logic.

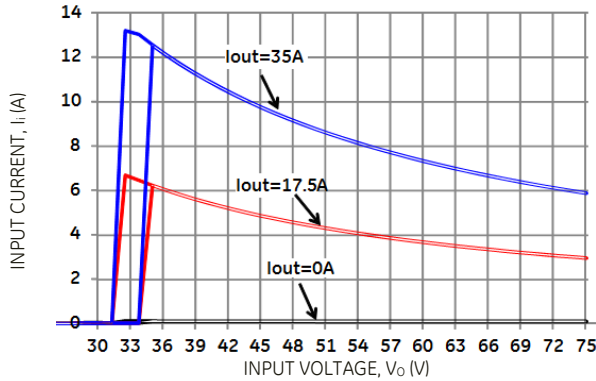

Figure 1. Typical Input Characteristic.

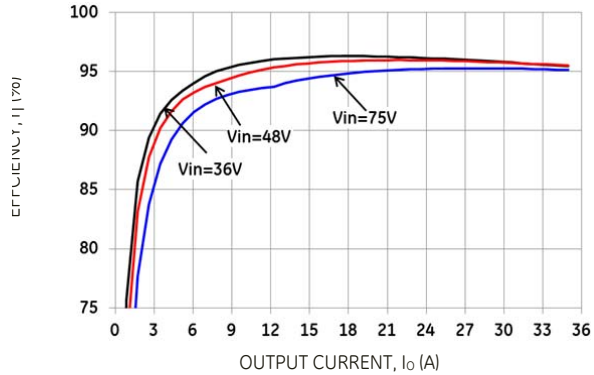

Figure 2. Typical Converter Efficiency vs. Output Current.

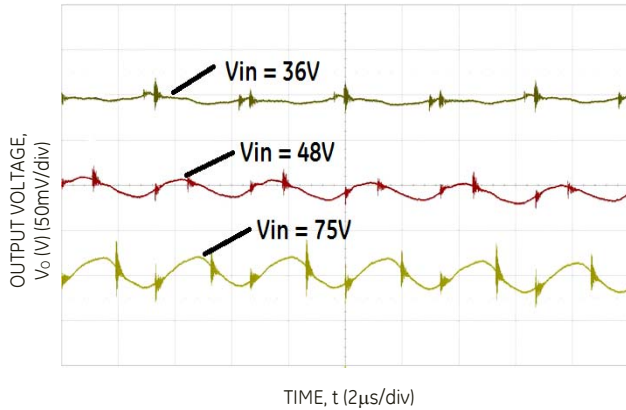

Figure 3. Typical Output Ripple and Noise, $I_o = I_{o,max}$, $C_o = C_{o,min}$

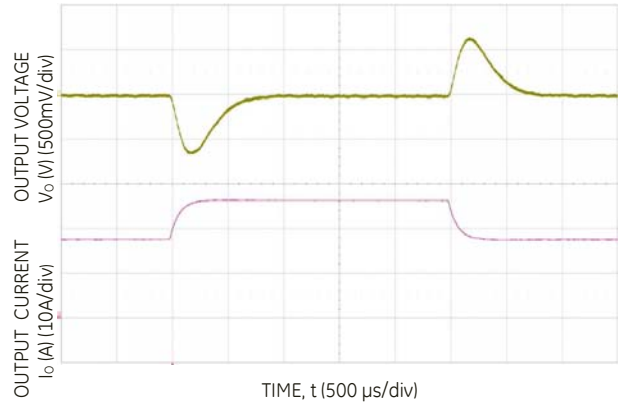

Figure 4. Typical Transient Response to 0.1A/μs Step Change in Load from 50% to 75% to 50% of Full Load, $C_o=470\mu F$ and 48 Vdc Input.

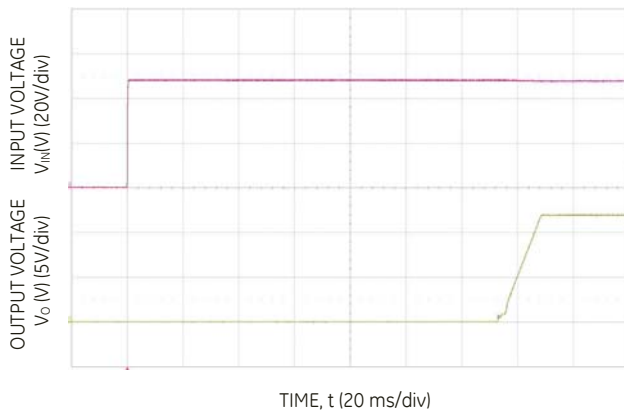

Figure 5. Typical Start-Up Using V_{in} with Remote On/Off enabled, negative logic version shown.

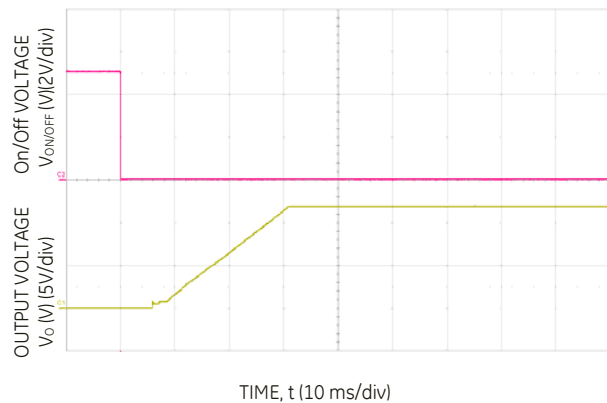

Figure 6. Typical Start-Up Using Remote On/Off with V_{in} applied, negative logic version shown.

QSDW035A0B Series Power Modules; DC-DC Converters
 36Vdc – 75Vdc Input; 12Vdc Output; 35A Output Current

Characteristic Curves (continued)

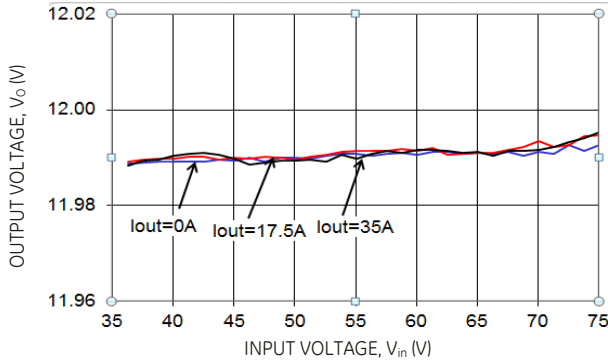

Figure 7. Typical Output Voltage Regulation vs. Input Voltage.

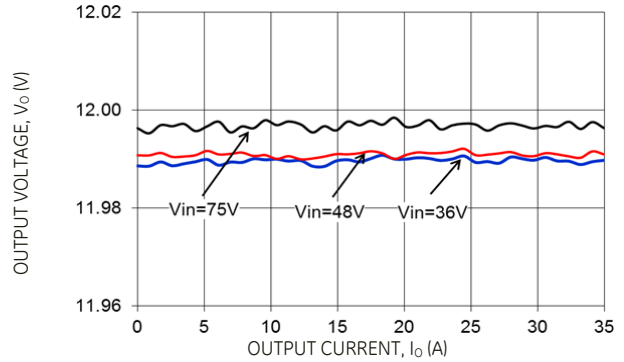

Figure 8. Typical Output Voltage Regulation vs. Output Current.

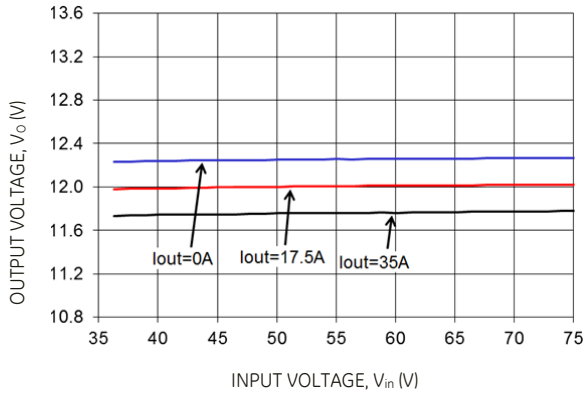

Figure 9. Typical Output Voltage Regulation vs. Input Voltage for the -P Version.

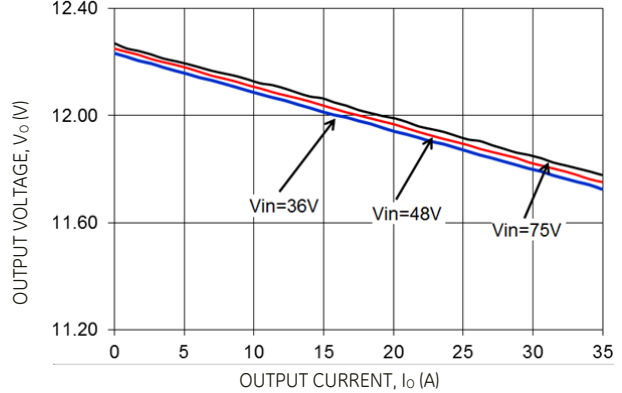
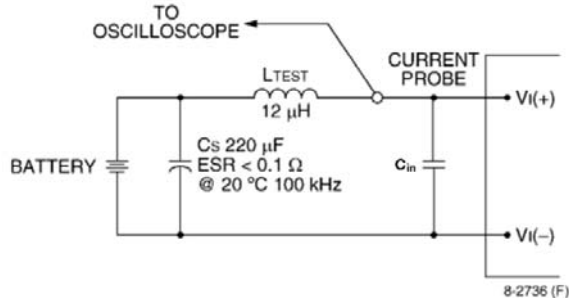

Figure 10. Typical Output Voltage Regulation vs. Output Current for the -P Version.

QSDW035A0B Series Power Modules; DC-DC Converters

36Vdc –75Vdc Input; 12Vdc Output; 35A Output Current

Test Configurations



Note: Measure input reflected-ripple current with a simulated source inductance (LTEST) of 12 µH. Capacitor CS offsets possible battery impedance. Measure current as shown above.

Figure 11. Input Reflected Ripple Current Test Setup.

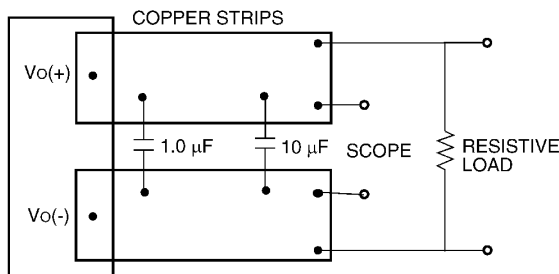

Note: Use a 1.0 µF ceramic capacitor and a 10 µF aluminum or tantalum capacitor. Scope measurement should be made using a BNC socket. Position the load between 51 mm and 76 mm (2 in. and 3 in.) from the module.

Figure 12. Output Ripple and Noise Test Setup.

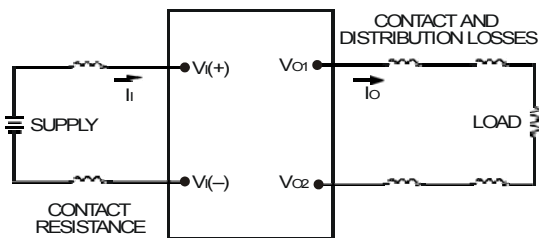

Note: All measurements are taken at the module terminals. When socketing, place Kelvin connections at module terminals to avoid measurement errors due to socket contact resistance.

$$\eta = \left(\frac{[V_{O(+)} - V_{O(-)}] I_O}{[V_{I(+)} - V_{I(-)}] I_I} \right) \times 100 \%$$

Figure 13. Output Voltage and Efficiency Test Setup.

Design Considerations

Input Source Impedance

The power module should be connected to a low ac-impedance source. A highly inductive source impedance can affect the stability of the power module. For the test configuration in Figure 11, a 220µF electrolytic capacitor, C_{in}, (ESR<0.7Ω at 100kHz), mounted close to the power module helps ensure the stability of the unit. If the module is subjected to rapid on/off cycles, a 330µF input capacitor is required. Consult the factory for further application guidelines.

Safety Considerations

For safety-agency approval of the system in which the power module is used, the power module must be installed in compliance with the spacing and separation requirements of the end-use safety agency standard, i.e., UL60950-1 2nd Ed., CSA C22.2 No. 60950-1 2nd Ed., and VDE0805-1 EN60950-1 2nd Ed.

If the input source is non-SELV (ELV or a hazardous voltage greater than 60 Vdc and less than or equal to 75Vdc), for the module's output to be considered as meeting the requirements for safety extra-low voltage (SELV), all of the following must be true:

- The input source is to be provided with reinforced insulation from any other hazardous voltages, including the ac mains.
- One V_{IN} pin and one V_{OUT} pin are to be grounded, or both the input and output pins are to be kept floating.
- The input pins of the module are not operator accessible.
- Another SELV reliability test is conducted on the whole system (combination of supply source and subject module), as required by the safety agencies, to verify that under a single fault, hazardous voltages do not appear at the module's output.

Note: Do not ground either of the input pins of the module without grounding one of the output pins. This may allow a non-SELV voltage to appear between the output pins and ground.

The power module has safety extra-low voltage (SELV) outputs when all inputs are SELV.

The input to these units is to be provided with a maximum 25A fast-acting (or time-delay) fuse in the ungrounded input lead.

The power module has internally generated voltages exceeding safety extra-low voltage. Consideration should be taken to restrict operator accessibility.

QSDW035A0B Series Power Modules; DC-DC Converters

36Vdc –75Vdc Input; 12Vdc Output; 35A Output Current

Feature Descriptions

Overcurrent Protection

To provide protection in a fault output overload condition, the module is equipped with internal current-limiting circuitry and can endure current limiting continuously. If the overcurrent condition causes the output voltage to fall greater than 4.0V from $V_{o, \text{set}}$, the module will shut down and remain latched off. The overcurrent latch is reset by either cycling the input power or by toggling the on/off pin for one second. If the output overload condition still exists when the module restarts, it will shut down again. This operation will continue indefinitely until the overcurrent condition is corrected.

A factory configured auto-restart option (with overcurrent and overvoltage auto-restart managed as a group) is also available. An auto-restart feature continually attempts to restore the operation until fault condition is cleared.

Output Overvoltage Protection

The module contains circuitry to detect and respond to output overvoltage conditions. If the overvoltage condition causes the output voltage to rise above the limit in the Specifications Table, the module will shut down. The QSDW035A0B module is factory default configured for auto-restart operation. The auto-restart feature continually attempts to restore the operation until fault condition is cleared. If the output overvoltage condition still exists when the module restarts, it will shut down again. This operation will continue indefinitely until the overvoltage condition is corrected.

A factory configured auto-restart option (with overcurrent and overvoltage auto-restart managed as a group) is also available. An auto-restart feature continually attempts to restore the operation until fault condition is cleared.

Overtemperature Protection

The modules feature an overtemperature protection circuit to safeguard against thermal damage. The circuit shuts down the module when the default maximum device reference temperature is exceeded. The module is factory default configured to automatically restart once the reference temperature cools by $\sim 25^{\circ}\text{C}$.

Input Under/Over Voltage Lockout

At input voltages above or below the input under/over voltage lockout limits, module operation is disabled. The module will begin to operate when the input voltage level changes to within the under and overvoltage lockout limits.

Remote On/Off

The module contains a standard on/off control circuit reference to the $V_{IN(-)}$ terminal. Two factory configured remote on/off logic options are available. Positive logic remote on/off turns the module on during a logic-high voltage on the ON/OFF pin, and off during a logic LO. Negative logic remote on/off turns the module off during a logic HI, and on during a logic LO. Negative logic, device

code suffix "1," is the factory-preferred configuration. The On/Off circuit is powered from an internal bias supply, derived from the input voltage terminals. To turn the power module on and off, the user must supply a switch to control the voltage between the On/Off terminal and the $V_{IN(-)}$ terminal ($V_{on/off}$). The switch can be an open collector or equivalent (see Figure 14). A logic LO is $V_{on/off} = -0.3\text{V}$ to 0.8V . The typical $I_{on/off}$ during a logic LO ($V_{in}=48\text{V}$, On/Off Terminal= 0.3V) is $147\mu\text{A}$. The switch should maintain a logic-low voltage while sinking $310\mu\text{A}$. During a logic HI, the maximum $V_{on/off}$ generated by the power module is 8.2V . The maximum allowable leakage current of the switch at $V_{on/off} = 2.0\text{V}$ is $10\mu\text{A}$. If using an external voltage source, the maximum voltage $V_{on/off}$ on the pin is 14.5V with respect to the $V_{IN(-)}$ terminal.

If not using the remote on/off feature, perform one of the following to turn the unit on:

For negative logic: short ON/OFF pin to $V_{IN(-)}$.

For positive logic: leave ON/OFF pin open.

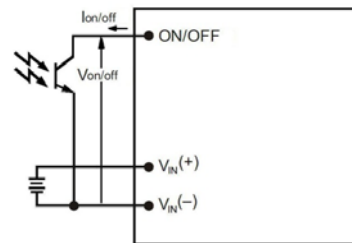

Figure 14. Remote On/Off Implementation.

Load Sharing

For higher power requirements, the QSDW035A0 power module offers an optional feature for parallel operation (-P Option code). This feature provides a precise forced output voltage load regulation droop characteristic. The output set point and droop slope are factory calibrated to insure optimum matching of multiple modules' load regulation characteristics. To implement load sharing, the following requirements should be followed:

- The $V_{OUT(+)}$ and $V_{OUT(-)}$ pins of all parallel modules must be connected together. Balance the trace resistance for each module's path to the output power planes, to insure best load sharing and operating temperature balance.
- V_{IN} must remain between 36V_{dc} and 75V_{dc} for droop sharing to be functional.
- It is permissible to use a common Remote On/Off signal to start all modules in parallel.
- These modules contain means to block reverse current flow upon start-up, when output voltage is present from other parallel modules, thus eliminating the requirement for external output ORing devices. Modules with the -P option will self-determine the presence of voltage on the output from other operating modules, and automatically increase its Turn On delay, T_{delay} , as specified in the Feature Specifications Table.

QSDW035A0B Series Power Modules; DC-DC Converters

36Vdc –75Vdc Input; 12Vdc Output; 35A Output Current

Feature Descriptions (continued)

- When parallel modules startup into a pre-biased output, e.g. partially discharged output capacitance, the T_{rise} is automatically increased, as specified in the Feature Specifications table, to insure graceful startup.
- Insure that the load is $<50\% I_{O,MAX}$ (for a single module) until all parallel modules have started (load full start $>$ module T_{delay} time \times T_{rise} time).
- If fault tolerance is desired in parallel applications, output ORing devices should be used to prevent a single module failure from collapsing the load bus.

Remote Sense

Remote sense minimizes the effects of distribution losses by regulating the voltage at the remote-sense connections (See Figure 15). The SENSE(-) pin should be always connected to VO(-). The voltage between the remote-sense pins and the output terminals must not exceed the output voltage sense range given in the Feature Specifications table:

$$[V_{o(+)} - V_{o(-)}] - [SENSE(+)] \leq 0.5 V$$

Although the output voltage can be increased by both the remote sense and by the trim, the maximum increase for the output voltage is not the sum of both. The maximum increase is the larger of either the remote sense or the trim. The amount of power delivered by the module is defined as the voltage at the output terminals multiplied by the output current. When using remote sense and trim, the output voltage of the module can be increased, which at the same output current, would increase the power output of the module. Care should be taken to ensure that the maximum output power of the module remains at or below the maximum rated power (Maximum rated power = $V_{o,set} \times I_{o,max}$).

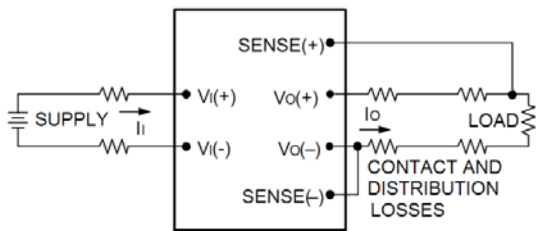

Figure 15. Circuit Configuration for remote sense.

Configurable Control Pins

The QSDW035A0B contains two configurable control pins, T/C1 and C2, referenced to the module secondary SIG_GND. See Mechanical Views for pin locations. The following table list the default factory configurations for the functions assigned to these pins. Additional configurations can be accomplished via the PMBus command, MFR_CPIN_ARA_CONFIG. Following the table, there is a feature description for each function.

Pin Designation/Function		Module Code	Configuration
T/C1	C2		
On/Off (O)	Power Good	w/o -P	Factory Default
Trim	On/Off (O)	w/o -P	Via PMBus
Trim	Power Good	w/o -P	Via PMBus
On/Off (O)	Power Good	with -P	Factory Default

Remote On/Off(o)

The module contains an additional remote on/off control input On/Off(o), via either the T/C1 or C2 pin, reference to the VO(-) terminal. The factory default configuration is set to ignore this input, unless activated by the PMBus command, MFR_CPIN_ON_OFF_CONFIG. This command is also used to configure the logic for the On/Off(o) pin. Positive logic remote on/off turns the module on during a logic-high voltage on the ON/OFF pin, and off during a logic low. Negative logic remote on/off turns the module off during a logic high, and on during a logic low. The On/Off(o) circuit is powered from an internal bias supply, referenced to SIG_GND. To turn the power module on and off, the user must supply a switch to control the voltage between the On/Off (o) terminal and the VO(-) terminal ($V_{on/off(o)}$). The switch can be an open collector or equivalent (see Figure 13). A logic low is $V_{on/off(o)} = -0.3V$ to $0.8V$. The typical $I_{on/off(o)}$ during a logic low is $330\mu A$. The switch should maintain a logic-low voltage while sinking $250\mu A$. During a logic high, the maximum $V_{on/off(o)}$ generated by the power module is $3.3V$. The maximum allowable leakage current of the switch at $V_{on/off(o)} = 2.0V$ is $130\mu A$. If using an external voltage source, the maximum voltage $V_{on/off}$ on the pin is $3.3V$ with respect to the V(-) terminal.

If not using the Remote On/Off(o) feature, the pin may be left N/C.

Power Good, PG

The QSDW035A0B module provides a Power Good (PG) feature, which compares the module's output voltage to the module's POWER_GOOD_ON and POWER_GOOD_OFF values. These values are adjustable via PMBus. PG is asserted when the module's output voltage is above the POWER_GOOD_ON value, and PG is de-asserted if any condition such as overtemperature, overcurrent or loss of regulation occurs that would result in the output voltage going below the POWER_GOOD_OFF value.

The PG signal, provided on pin C2, is implemented with an open-drain node, pulled up via a $10k\Omega$ resistor to $3.3V$ internally. For Positive Logic PG (default), the PG signal is HI, when PG is asserted, and LO, when the PG is de-asserted. For Negative Logic PG, the PG signal is LO, when PG is asserted, and HI, when the PG is de-asserted.

The PMBus command MFR_PGOOD_POLARITY is used to set the logic polarity of the signal.

If not using the Power Good feature, the pin may be left N/C.

QSDW035A0B Series Power Modules; DC-DC Converters

36Vdc –75Vdc Input; 12Vdc Output; 35A Output Current

Trim, Output Voltage Programming

Trimming allows the output voltage set point to be increased or decreased; this is accomplished by connecting an external resistor between the TRIM pin and either the Vo(+) pin or the Vo(-) pin.

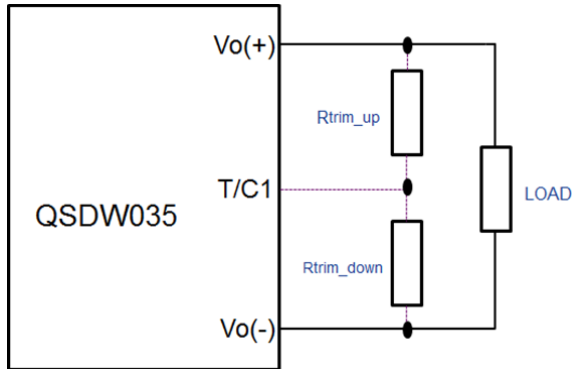

Figure 15. Circuit Configuration to Trim Output Voltage.

Connecting an external resistor ($R_{trim-down}$) between the T/C1 pin and the Vo(-) (or Sense(-)) pin decreases the output voltage set point. To maintain set point accuracy, the trim resistor tolerance should be $\pm 1.0\%$.

The following equation determines the required external resistor value to obtain a percentage output voltage change of $\Delta\%$.

$$R_{trim-down} = \left[\frac{511}{\Delta\%} - 10.22 \right] \text{K}\Omega$$

Where $\Delta\% = \left(\frac{12.0V - V_{desired}}{12.0V} \right) \times 100$

For example, to trim-down the output voltage of the module by 20% to 9.6V, $R_{trim-down}$ is calculated as follows:

$$\Delta\% = 20$$

$$R_{trim-down} = \left[\frac{511}{20} - 10.22 \right] \text{K}\Omega$$

$$R_{trim-down} = 15.3\text{k}\Omega$$

Connecting an external resistor ($R_{trim-up}$) between the T/C1 pin and the Vo(+) (or Sense (+)) pin increases the output voltage set point. The following equations determine the required external resistor value to obtain a percentage output voltage change of $\Delta\%$:

$$R_{trim-up} = \left[\frac{5.11 \times 12.0V \times (100 + \Delta\%)}{1.225 \times \Delta\%} - \frac{511}{\Delta\%} - 10.22 \right] \text{K}\Omega$$

Where $\Delta\% = \left(\frac{V_{desired} - 12.0V}{12.0V} \right) \times 100$

For example, to trim-up the output voltage of the module by 5% to 12.6V, $R_{trim-up}$ is calculated as follows:

$$\Delta\% = 5$$

$$R_{trim-up} = \left[\frac{5.11 \times 12.0 \times (100 + 5)}{1.225 \times 5} - \frac{511}{5} - 10.22 \right] \text{K}\Omega$$

$$R_{trim-up} = 938.8\text{K}\Omega$$

The voltage between the Vo(+) and Vo(-) terminals must not exceed the minimum output overvoltage protection value shown in the Feature Specifications table. This limit includes any increase in voltage due to remote-sense compensation and output voltage set-point adjustment trim.

Although the output voltage can be increased by both the remote sense and by the trim, the maximum increase for the output voltage is not the sum of both. The maximum increase is the larger of either the remote sense or the trim. The amount of power delivered by the module is defined as the voltage at the output terminals multiplied by the output current. When using remote sense and trim, the output voltage of the module can be increased, which at the same output current would increase the power output of the module. Care should be taken to ensure that the maximum output power of the module remains at or below the maximum rated power (Maximum rated power = $V_{O,set} \times I_{O,max}$).

QSDW035A0B Series Power Modules; DC-DC Converters

36Vdc –75Vdc Input; 12Vdc Output; 35A Output Current

Feature Descriptions (continued)

Thermal Considerations

The thermal data presented here is based on physical measurements taken in a wind tunnel, using automated thermo-couple instrumentation to monitor key component temperatures: FETs, diodes, control ICs, magnetic cores, ceramic capacitors, opto-isolators, and module pwb conductors, while controlling the ambient airflow rate and temperature. For a given airflow and ambient temperature, the module output power is increased, until one (or more) of the components reaches its maximum derated operating temperature, as defined in IPC-9592B. This procedure is then repeated for a different airflow or ambient temperature until a family of module output derating curves is obtained.

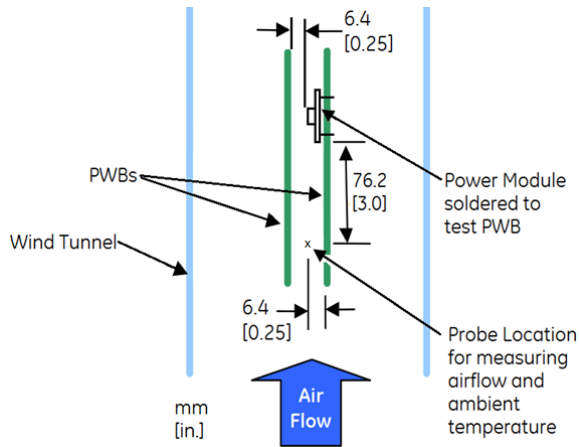

The power modules operate in a variety of thermal environments and sufficient cooling should be provided to help ensure reliable operation. Thermal considerations include ambient temperature, airflow, module power dissipation, and the need for increased reliability. A reduction in the operating temperature of the module will result in an increase in reliability.

Heat-dissipating components are mounted on the top side of the module. Heat is removed by conduction, convection and radiation to the surrounding environment. Proper cooling can be verified by measuring the thermal reference temperature (TH₁ or TH₂). Peak temperature occurs at the position indicated in Figure 16 and 17. For reliable operation this temperature should not exceed TREF = 125°C, and TREF1=105°C or TREF2=105°C. For extremely high reliability you can limit this temperature to a lower value.

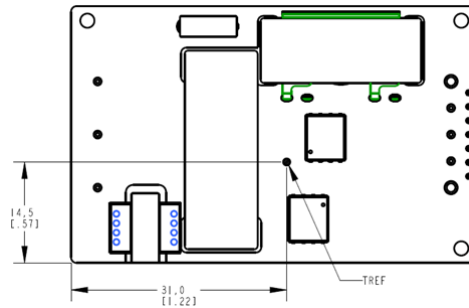

Figure 16. Location of the thermal reference temperature TH.

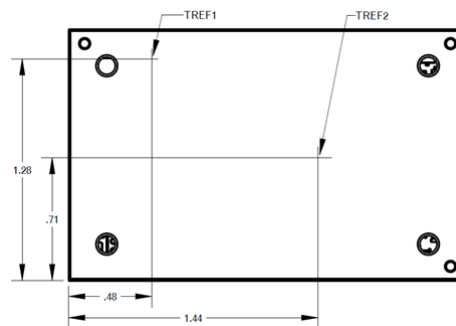

Figure 17. Location of the thermal reference temperature TH3 for Baseplate module.

The output power of the module should not exceed the rated power for the module as listed in the Ordering Information table.

Please refer to the Application Note “Thermal Characterization Process For Open-Frame Board-Mounted Power Modules” for a detailed discussion of thermal aspects including maximum device temperatures.

Heat Transfer via Convection

Increased airflow over the module enhances the heat transfer via convection. The thermal derating of figure 18-19 shows the maximum output current that can be delivered by each module in the indicated orientation without exceeding the maximum TH_x temperature versus local ambient temperature (T_A) for several air flow conditions.

The use of Figure 18 is shown in the following example:

Example

What is the minimum airflow necessary for a QSDW035A0B operating at V_i = 48 V, an output current of 20A, and a maximum ambient temperature of 60 °C in transverse orientation.

Solution:

Given: V_{in} = 48V, I_o = 20A, T_A = 60 °C

Determine required airflow velocity (Use Figure 18):

Velocity = 0.5m/s (100 LFM) or greater.

QSDW035A0B Series Power Modules; DC-DC Converters

36Vdc –75Vdc Input; 12Vdc Output; 35A Output Current

Thermal Considerations (continued)

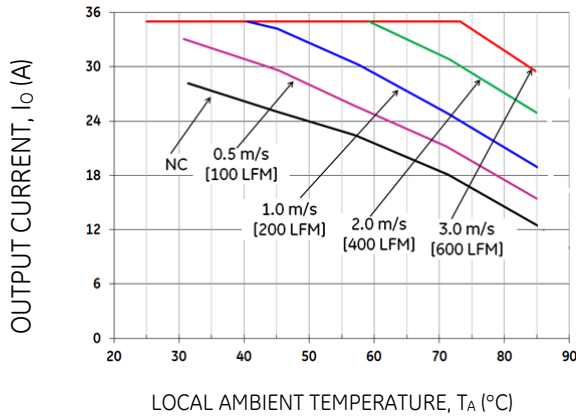

Figure 18. Output Current Derating for the Open Frame QSDW035A0B in the Transverse Orientation; Airflow Direction from Vin(-) to Vin(+); Vin = 48V.

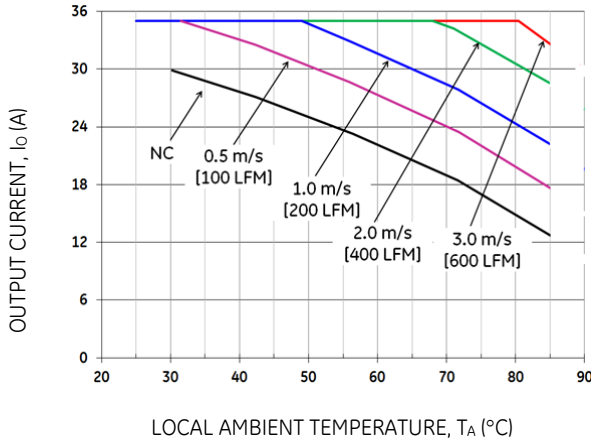

Figure 19. Output Current Derating for the Base plate QSDW035A0B-H in the Transverse Orientation; Airflow Direction from Vin(-) to Vin(+); Vin = 48V.

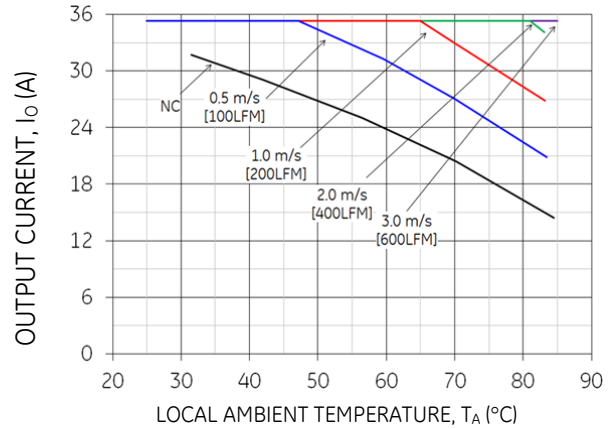

Figure 20. Output Current Derating for the Base plate QSDW035A0B-H with 0.25" heatsink in the Transverse Orientation; Airflow Direction from Vin(-) to Vin(+); Vin = 48V

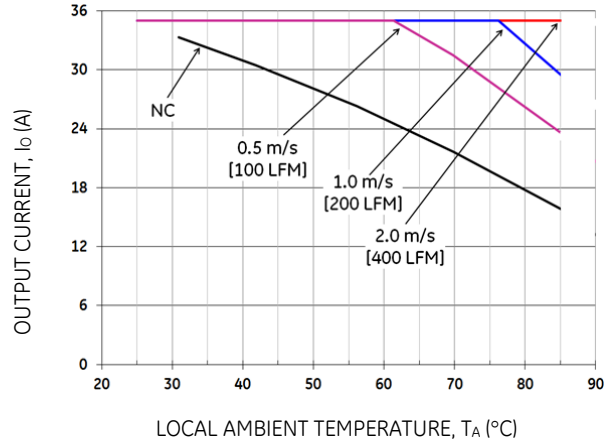

Figure 21. Output Current Derating for the Base plate QSDW035A0B-H with 0.5" heatsink in the Transverse Orientation; Airflow Direction from Vin(-) to Vin(+); Vin = 48V

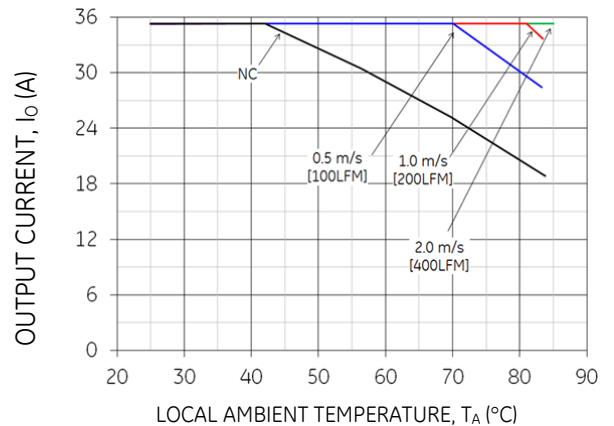

Figure 22. Output Current Derating for the Base plate QSDW035A0B-H with 1.0" heatsink in the Transverse Orientation; Airflow Direction from Vin(-) to Vin(+); Vin = 48V.

QSDW035A0B Series Power Modules; DC-DC Converters

36Vdc –75Vdc Input; 12Vdc Output; 35A Output Current

Layout Considerations

The QSDW035A0B power module series are low profile in order to be used in fine pitch system card architectures. As such, component clearance between the bottom of the power module and the mounting board is limited. Avoid placing copper areas on the outer layer directly underneath the power module. Also avoid placing via interconnects underneath the power module.

For additional layout guide-lines, refer to FLTR100V10 Data Sheet.

Through-Hole Lead-Free Soldering Information

The RoHS-compliant, Z version, through-hole products use the SAC (Sn/Ag/Cu) Pb-free solder and RoHS-compliant components. The non-Z version products use lead-tin (Pb/Sn) solder and RoHS-compliant components. Both version modules are designed to be processed through single or dual wave soldering machines. The pins have an RoHS-compliant, pure tin finish that is compatible with both Pb and Pb-free wave soldering processes. A maximum preheat rate of 3°C/s is suggested. The wave preheat process should be such that the temperature of the power module board is kept below 210°C. For Pb solder, the recommended pot temperature is 260°C, while the Pb-free solder pot is 270°C max. Not all RoHS-compliant through-hole products can be processed with paste-through-hole Pb or Pb-free reflow process. If additional information is needed, please consult with your GE representative for more details.

Reflow Lead-Free Soldering Information

The RoHS-compliant through-hole products can be processed with the following paste-through-hole Pb or Pb-free reflow process.

Max. sustain temperature :

245°C (J-STD-020C Table 4-2: Packaging Thickness \geq 2.5mm / Volume > 2000mm³),

Peak temperature over 245°C is not suggested due to the potential reliability risk of components under continuous high-temperature.

Min. sustain duration above 217°C : 90 seconds

Min. sustain duration above 180°C : 150 seconds

Max. heat up rate: 3°C/sec

Max. cool down rate: 4°C/sec

In compliance with JEDEC J-STD-020C spec for 2 times reflow requirement.

Pb-free Reflow Profile

BMP module will comply with J-STD-020 Rev. C (Moisture/Reflow Sensitivity Classification for Nonhermetic Solid State Surface Mount Devices) for both Pb-free solder profiles and MSL classification procedures. BMP will comply with JEDEC J-STD-020C specification for 3 times reflow requirement. The suggested Pb-free solder paste is Sn/Ag/Cu (SAC). The recommended

linear reflow profile using Sn/Ag/Cu solder is shown in Figure 23.

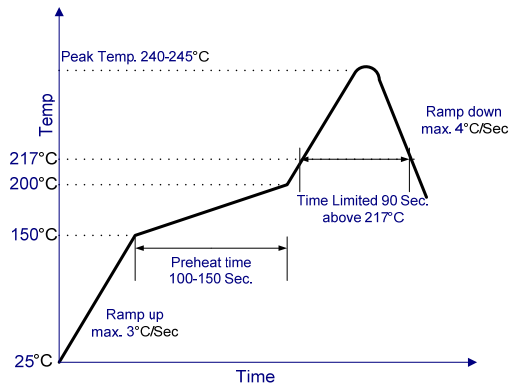

Figure 23. Recommended linear reflow profile using Sn/Ag/Cu solder.

MSL Rating

The QSDW035A0B modules have a MSL rating of 2a.

Storage and Handling

The recommended storage environment and handling procedures for moisture-sensitive surface mount packages is detailed in J-STD-033 Rev. A (Handling, Packing, Shipping and Use of Moisture/Reflow Sensitive Surface Mount Devices). Moisture barrier bags (MBB) with desiccant are required for MSL ratings of 2 or greater. These sealed packages should not be broken until time of use. Once the original package is broken, the floor life of the product at conditions of \leq 30°C and 60% relative humidity varies according to the MSL rating (see J-STD-033A). The shelf life for dry packed SMT packages will be a minimum of 12 months from the bag seal date, when stored at the following conditions: < 40° C, < 90% relative humidity.

Post Solder Cleaning and Drying Considerations

Post solder cleaning is usually the final circuit-board assembly process prior to electrical board testing. The result of inadequate cleaning and drying can affect both the reliability of a power module and the testability of the finished circuit-board assembly. For guidance on appropriate soldering, cleaning and drying procedures, refer to GE *Board Mounted Power Modules: Soldering and Cleaning* Application Note (AP01-056EPS).

QSDW035A0B Series Power Modules; DC-DC Converters

36Vdc –75Vdc Input; 12Vdc Output; 35A Output Current

Digital Feature Descriptions

PMBus Interface Capability

The QSDW035A0B series is equipped with a digital PMBus interface to allow the module to be configured, and communicate with system controllers. Detailed timing and electrical characteristics of the PMBus can be found in the PMB Power Management Protocol Specification, Part 1, revision 1.2, available at <http://pmbus.org>. The QSDW035A0B supports both the 100kHz and 400kHz bus timing requirements. The QSDW035A0B shall stretch the clock, as long as it does not exceed the maximum clock LO period of 35ms. The QSDW035A0B will check the Packet Error Checking scheme (PEC) byte, if provided by the PMBus master, and include a PEC byte in all responses to the master. However, the QSDW035A0B does not require a PEC byte from the PMBus master.

The QSDW035A0B supports a subset of the commands in the PMBus 1.2 specification. Most all of the controller parameters can be programmed using the PMBus and stored as defaults for later use. All commands that require data input or output use the linear format. The exponent of the data words is fixed at a reasonable value for the command and altering the exponent is not supported. Direct format data input or output is not supported by the QSDW035A0B. The supported commands are described in greater detail below.

The QSDW035A0B contains non-volatile memory that is used to store configuration settings and scale factors. The settings programmed into the device are not automatically saved into this non-volatile memory though. The STORE_DEFAULT_ALL command must be used to commit the current settings to non-volatile memory as device defaults. The settings that are capable of being stored in non-volatile memory are noted in their detailed descriptions.

SMBALERT Interface Capability

The QSDW035A0B also supports the SMBALERT response protocol. The SMBALERT response protocol is a mechanism through which the QSDW035A0B can alert the PMBus master that it has an active status or alarm condition via pulling the SMBALERT pin to an active low. The master processes this condition, and simultaneously addresses all slaves on the PMBus through the Alert Response Address. Only the slave(s) that caused the alert (and that support the protocol) acknowledges this request. The master performs a modified receive byte operation to get the slave's address. At this point, the master can use the PMBus status commands to query the slave that caused the alert. Note: The QSDW035A0B can only respond to a single address at any given time. Therefore, the factory default state for the QSDW035A0B module is to retain its resistor programmed address, when it is in an ALERT active condition, and not respond to the ARA. This allows master systems, which do not support ARA, to continue to communicate with the slave QSDW035A0B using the programmed address, and using the various READ_STATUS commands to determine the

cause for the SMBALERT. The CLEAR_FAULTS command will retire the active SMBALERT. However, when the QSDW035A0B module is used in systems that do support ARA, Bit 4 of the MFR_CPIN_ARA_CONFIG command can be used to reconfigure the module to utilize ARA. In this case, the QSDW035A0B will no longer respond to its programmed address, when in an ALERT active state. The master is expected to perform the modified received byte operation, and retire the ALERT active signal. At this time, the QSDW035A0B will return to its resistor programmed address, allowing normal master-slave communications to proceed. The QSDW035A0B does not contain capability to arbitrate data bus contention caused by multiple modules responding to the modified received byte operation. Therefore, when the ARA is used in a multiple module PMBus application, it is necessary to have the QSDW035A0B module at the lowest programmed address in order for the host to properly determine all modules' address that are associated with an active SMBALERT. Please contact your GE sales representative for further assistance, and for more information on the SMBus alert response protocol, see the System Management Bus (SMBus) specification.

PMBus Addressing

The power module can be addressed through the PMBus using a device address. The module has 64 possible addresses (0 to 63 in decimal) which can be set using resistors connected from the ADDR0 and ADDR1 pins to GND. Note that some of these addresses (0 through 12, 40, 44, 45, and 55 in decimal) are reserved according to the SMBus specifications and may not be useable. The address is set in the form of two octal (0 to 7) digits, with each pin setting one digit. The ADDR1 pin sets the high order digit and ADDR0 sets the low order digit. The resistor values suggested for each digit are shown in Table 4 (1% tolerance resistors are recommended).

Table 4

Digit	Resistor Value (KΩ)
0	10
1	15.4
2	23.7
3	36.5
4	54.9
5	84.5
6	130
7	200

QSDW035A0B Series Power Modules; DC-DC Converters

36Vdc –75Vdc Input; 12Vdc Output; 35A Output Current

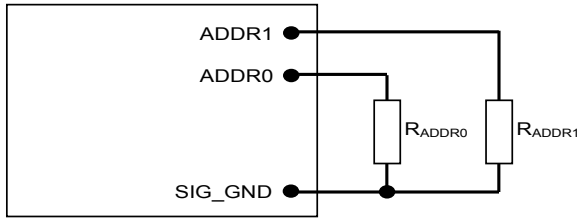
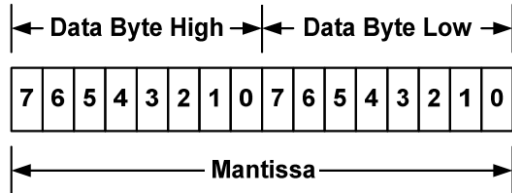

Figure 24. Circuit showing connection of resistors used to set the PMBus address of the module.

The user must know which I²C addresses are reserved in a system for special functions and set the address of the module to avoid interfering with other system operations. Both 100kHz and 400kHz bus speeds are supported by the module. Connection for the PMBus interface should follow the High Power DC specifications given in section 3.1.3 in the SMBus specification V2.0 for the 400kHz bus speed or the Low Power DC specifications in section 3.1.2. The complete SMBus specification is available from the SMBus web site, smbus.org.

PMBus Data Format

For commands that set or report any voltage thresholds related to output voltage (including VOUT_COMMAND, VOUT_MARGIN, POWER_GOOD and READ_VOUT), the module supports the linear data format consisting of a two byte value with a 16-bit, unsigned mantissa, and a fixed exponent of -12. The format of the two data bytes is shown below:



The value of the number is then given by

$$\text{Value} = \text{Mantissa} \times 2^{-12}$$

For commands that set all other thresholds, voltages or report such quantities, the module supports the linear data format consisting of a two byte value with an 11-bit, two's complement mantissa and a 5-bit, two's complement exponent. The format of the two data bytes is shown below:

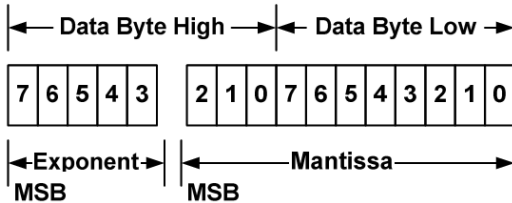

The value of the number is then given by

$$\text{Value} = \text{Mantissa} \times 2^{\text{Exponent}}$$

PMBus Enabled On/Off

The module can also be turned on and off via the PMBus interface. The OPERATION command is used to actually turn the module on and off via the PMBus, while the ON_OFF_CONFIG command configures the combination of analog ON/OFF pin input and PMBus commands needed to turn the module on and off. Bit [7] in the OPERATION command data byte enables the module, with the following functions:

- 0 : Output is disabled
- 1 : Output is enabled

This module uses the lower five bits of the ON_OFF_CONFIG data byte to set various ON/OFF options as follows:

Bit Position	4	3	2	1	0
Access	r	r/w	r	r	r
Function	PU	CMD	CPR	POL	CPA
Default Value	1	1	1	1	1

PU: Factory set to 1. QSDW035A0B requires On/Off(i) pin to be connected to proper input rail for module to power up. This bit is used together with the CMD, CPR and ON bits to determine startup.

Bit Value	Action
0	Module does not power up until commanded by the analog ON/OFF pin and the OPERATION command as programmed in bits [2:0] of the ON_OFF_CONFIG register.
1	Module responds to the ON bit in the OPERATION command.

CMD: The CMD bit controls how the device responds to the OPERATION command.

Bit Value	Action
0	Module ignores the ON bit in the OPERATION command.
1	Module responds to the ON bit in the OPERATION command.

CPR: Factory set to 1. QSDW035A0B requires On/Off(i) pin to be connected to proper input rail for module to power up. This bit is used together with the CMD and ON bits to determine startup.

Bit Value	Action
0	Module requires the analog ON/OFF pin to be asserted to start the unit.
1	Module requires the analog ON/OFF pin to be asserted to start the unit.

PMBus Adjustable Input Undervoltage Lockout

The module allows adjustment of the input under voltage lockout and hysteresis. The command VIN_ON allows setting the input voltage turn on threshold, while the VIN_OFF command sets the input voltage turn off threshold. For both the VIN_ON and VIN_OFF commands, possible values range from 32.000 to 46.000V in 0.125V steps. VIN_ON must be 2.000V greater than VIN_OFF.

Both the VIN_ON and VIN_OFF commands use the "Linear" format with two data bytes. The upper five bits [7:3] of the high data byte form the two's complement representation of the exponent, which is fixed at -3 (decimal). The remaining

QSDW035A0B Series Power Modules; DC-DC Converters

36Vdc –75Vdc Input; 12Vdc Output; 35A Output Current

11 bits are used for two's complement representation of the mantissa, with the 11th bit fixed at zero since only positive numbers are valid. The data associated with VIN_ON and VIN_OFF can be stored to non-volatile memory using the STORE_DEFAULT_ALL command.

PMBus Adjustable Soft Start Delay and Rise Time

The soft start delay and rise time can be adjusted in the module via PMBus. The TON_DELAY command sets the delay time in ms, and allows choosing delay times between 10ms and 500ms, with resolution of 0.5ms. The TON_RISE command sets the rise time in ms, and allows choosing soft start times between 15ms and 500ms, with resolution of 0.5ms. When setting TON_RISE, make sure that the charging current for output capacitors can be delivered by the module in addition to any load current to avoid nuisance tripping of the overcurrent protection circuitry during startup. Both the TON_RISE and TON_DELAY commands use the "Linear" format with two data bytes. The upper five bits [7:3] of the high data byte form the two's complement representation of the exponent, which is fixed at -1 (decimal). The remaining 11 bits are used for two's complement representation of the mantissa, with the 11th bit fixed at zero since only positive numbers are valid. The data associated with TON_RISE and TON_DELAY can be stored to non-volatile memory using the STORE_DEFAULT_ALL command.

Output Voltage Adjustment Using the PMBus

The QSDW035A0B module output voltage set point is adjusted using the VOUT_COMMAND. The output voltage setting uses the Linear data format, with the 16 bits of the VOUT_COMMAND formatted as an unsigned mantissa, and a fixed exponent of -12 (decimal) (read from VOUT_MODE).

$$V_{OUT} = \text{Mantissa} \times 2^{-12}$$

The range limits for VOUT_COMMAND are 8.10V to 13.20V, and the resolution is 0.244mV.

The data associated with VOUT_COMMAND can be stored to non-volatile memory using the STORE_DEFAULT_ALL command.

Output Voltage Margining Using the PMBus

The QSDW035A0B module can also have its output voltage margined via PMBus commands. The command VOUT_MARGIN_HIGH sets the margin high voltage, while the command VOUT_MARGIN_LOW sets the margin low voltage. Both the VOUT_MARGIN_HIGH and VOUT_MARGIN_LOW commands use the "Linear" mode with the exponent fixed at -12 (decimal). The data associated with VOUT_MARGIN_HIGH and VOUT_MARGIN_LOW can be stored to non-volatile memory using the STORE_DEFAULT_ALL command.

The module is commanded to go to the margined high or low voltages using the OPERATION command. Bits [5:2] are used to enable margining as follows:

- 00XX : Margin Off
- 0110 : Margin Low (Act on Fault)

- 1010 : Margin High (Act on Fault)

Measuring Output Voltage Using the PMBus

The module can provide output voltage information using the READ_VOUT command. The command returns two bytes of data in the linear format, with the 16 bits of the READ_VOUT formatted as an unsigned mantissa, and a fixed exponent of -12 (decimal).

During module manufacture, an offset correction value is written into the non-volatile memory of the module to null errors in the tolerance and A/D conversion of V_{OUT}. The command MFR_VOUT_READ_CAL_OFFSET can be used to read the offset - two bytes consisting of a signed 16-bit mantissa in two's complement format, using a fixed exponent of -12 (decimal). The resolution is 0.244mV. The corrected Output voltage reading is then given by:

$$V_{OUT}(\text{Read}) = [V_{OUT}(A/D) + MFR_VOUT_READ_CAL_OFFSET]$$

Measuring Input Voltage Using the PMBus

The module can provide input voltage information using the READ_VIN command. The command returns two bytes of data in the linear format. The upper five bits [7:3] of the high data byte form the two's complement representation of the exponent, which is fixed at -3 (decimal). The remaining 11 bits are used for two's complement representation of the mantissa, with the 11th bit fixed at zero since only positive numbers are valid.

During module manufacture, offset and gain correction values are written into the non-volatile memory of the module to null errors in the tolerance and A/D conversion of Vin. The command MFR_VIN_READ_CAL_OFFSET can be used to read the offset - two bytes consisting of a five-bit exponent (fixed at -3) and a 11-bit mantissa in two's complement format. The resolution is 125mV. The command MFR_VIN_READ_CAL_GAIN can be used to read the gain correction - two bytes consisting of an unsigned 16 bit number. The resolution of this correction factor 0.000122. The corrected input voltage reading is then given by:

$$V_{IN}(\text{Read}) = [V_{IN}(A/D) \times (MFR_VIN_READ_CAL_GAIN^{8192}) + MFR_VIN_READ_CAL_OFFSET]$$

Measuring Output Current Using the PMBus

The module measures output current by using the output filter inductor winding resistance as a current sense element. The module can provide output current information using the READ_IOUT command. The command returns two bytes of data in the linear format. The upper five bits [7:3] of the high data byte form the two's complement representation of the exponent, which is fixed at -4 (decimal). The remaining 11 bits are used for two's complement representation of the mantissa, with the 11th

QSDW035A0B Series Power Modules; DC-DC Converters 36Vdc –75Vdc Input; 12Vdc Output; 35A Output Current

bit fixed at zero since only positive numbers are valid. Output current readings are blanked below 1.65A.

During module manufacture, offset and gain correction values are written into the non-volatile memory of the module to null errors in the tolerance and A/D conversion of I_{OUT} . The command `MFR_IOUT_CAL_OFFSET` can be used to read the offset - two bytes consisting of a five-bit exponent (fixed at -4) and a 11-bit mantissa in two's complement format. The resolution is 62.5mA. The command `MFR_IOUT_CAL_GAIN` can be used to read the gain correction - two bytes consisting of an unsigned 16 bit number. The resolution of this correction factor 0.000122. The `READ_IOUT` command provides module average output current information. This command only supports positive current sourced from the module. If the converter is sinking current a reading of 0 is provided.

$$I_{OUT}(\text{Read}) = [I_{OUT}(A/D) \times (MFR_IOUT_CAL_GAIN/8192)] + MFR_IOUT_CAL_OFFSET$$

Note that the current reading provided by the module is corrected for temperature.

Measuring the Temperature using the PMBus

The module can provide temperature information using the `READ_TEMPERATURE_1` command. The command returns two bytes of data in the linear format. The upper five bits [7:3] of the high data byte form the two's complement representation of the exponent, which is fixed at -2 (decimal). The remaining 11 bits are used for two's complement representation of the mantissa.

Note that the module's temperature sensor is located close to the module hot spot TH_1 (see Thermal Considerations), and is subjected to temperatures higher than the ambient air temperature near the module. The temperature reading will be highly influenced by module load and airflow conditions.

Reading the Status of the Module using the PMBus

The module supports a number of status information commands implemented in PMBus. However, not all features are supported in these commands. A X in the FLAG cell indicates the bit is not supported.

`STATUS_WORD` : Returns two bytes of information with a summary of the module's fault/warning conditions.

High Byte

Bit Position	Flag	Default Value
15	VOUT fault	0
14	IOUT fault or warning	0
13	Input Voltage fault	0
12	X	0
11	POWER_GOOD# (is negated)	0
10	X	0
9	X	0
8	X	0

Low Byte

Bit Position	Flag	Default Value
7	X	0
6	OFF	0
5	VOUT Overvoltage	0
4	IOUT Overcurrent	0
3	VIN Undervoltage	0
2	Temperature	0
1	CML (Comm. Memory Fault)	0
0	X	0

`STATUS_VOUT` : Returns one byte of information relating to the status of the module's output voltage related faults.

Bit Position	Flag	Default Value
7	VOUT OV Fault	0
6	X	0
5	X	0
4	X	0
3	X	0
2	X	0
1	X	0
0	X	0

`STATUS_IOUT` : Returns one byte of information relating to the status of the module's output current related faults.

Bit Position	Flag	Default Value
7	IOUT OC Fault	0
6	X	0
5	IOUT OC Warning	0
4	X	0
3	X	0
2	X	0
1	X	0
0	X	0

QSDW035A0B Series Power Modules; DC-DC Converters

36Vdc –75Vdc Input; 12Vdc Output; 35A Output Current

STATUS_INPUT : Returns one byte of information relating to the status of the module's input voltage related faults.

Bit Position	Flag	Default Value
7	VIN OV Fault	0
6	X	0
5	X	0
4	VIN UV Fault	0
3	Module Off (Low VIN)	0
2	X	0
1	X	0
0	X	0

STATUS_TEMPERATURE : Returns one byte of information relating to the status of the module's temperature related faults.

Bit Position	Flag	Default Value
7	OT Fault	0
6	OT Warning	0
5	X	0
4	X	0
3	X	0
2	X	0
1	X	0
0	X	0

STATUS_CML : Returns one byte of information relating to the status of the module's communication related faults.

Bit Position	Flag	Default Value
7	Invalid/Unsupported Command	0
6	Invalid/Unsupported Data	0
5	Packet Error Check Failed	0
4	X	0
3	X	0
2	X	0
1	X	0
0	X	0

QSDW035A0B Series Power Modules; DC-DC Converters

36Vdc –75Vdc Input; 12Vdc Output; 35A Output Current

Summary of Supported PMBus Commands

This section outlines the PMBus command support for the QSDW035A0B bus converters. Each supported command is outlined in order of increasing command codes with a quick reference table of all supported commands included at the end of the section. Each command will have the following basic information.

Command Name [Code]

Command support

Data format

Factory default

Additional information may be provided in tabular form or other format, if necessary.

OPERATION [0x01]

Command support: On/Off Immediate and Margins (Act on Fault). Soft off with sequencing not supported and Margins (Ignore Fault) not supported. Therefore bits 6, 3, 2, 1 and 0 set as read only at factory defaults.

Format	8 bit unsigned (bit field)							
Bit Position	7	6	5	4	3	2	1	0
Access	r/w	r	r/w	r/w	r	r	r	r
Function	ON/OFF		Bits[5:4]		Bits[3:2]		N/A	
Default Value	1	0	0	0	1	0	0	0

ON_OFF_CONFIG [0x02]

Command support: Bit 1 polarity will be set based upon module code [0=Negative on/off logic, 1=positive on/off logic to allow customer system to know hardware on/off logic

Format	8 bit unsigned (bit field)							
Bit Position	7	6	5	4	3	2	1	0
Access	r	r	r	r	r	r/w	r	r
Function	(reserved)			Bit 4 pu	Bit 3 cmd	Bit 2 cpr	Bit 1 pol	Bit 0 cpa
Default Value	0	0	0	1	1	1	module code	1

CLEAR_FAULTS [0x03]

Command support: All functionality

STORE_DEFAULT_ALL[0x11]

Command support: All functionality – Stores operating parameters to EEprom memory.

Command requires ≤ 500ms to execute. Delay any additional commands to module for sufficient time to complete execution.

RESTORE_DEFAULT_ALL[0x12]

Command support: All functionality – Restores operating parameters from EEprom memory.

Command requires ≤ 200ms to execute. Delay any additional commands to module for sufficient time to complete execution.

VOUT_MODE[0x20]

Command support: Supported. Factory default: 0x14 - indicates linear mode with exp = -12

Format	8 bit unsigned (bit field)							
Bit Position	7	6	5	4	3	2	1	0
Access	r	r	r	r	r	r	r	r
Function	Mode (linear)				2's complement exponent			
Default Value	0	0	0	1	0	1	0	0

VOUT_COMMAND [0x21]

Data format: 16 bit unsigned mantissa (implied exponent per VOUT_MODE)

Factory default: 12.000V (12.00/2⁻¹² → 49,152 = 0xC000) [standard code]

Range limits (max/min): 13.200V/5.000V

Units: volt

Command support: Supported

VOUT_CAL_OFFSET [0x23]

Range limits (max/min): +0.25/-0.25

Units: volt

Command support: read/write support, lockout per MFR_DEVICE_TYPE, functionality implemented

QSDW035A0B Series Power Modules; DC-DC Converters

36Vdc –75Vdc Input; 12Vdc Output; 35A Output Current

VOUT_MARGIN_HIGH [0x25]

Range limits (max/min): 13.2/5.0

Units: volt

Command support: read/write support, full functionality except "Ignore faults".

Note: Range cross-check - value must be greater than VOUT_MARGIN_LOW value.

VOUT_MARGIN_LOW [0x26]

Range limits (max/min): 13.2/5.0

Units: volt

Command support: read/write support, full functionality except "Ignore faults".

Note: Range cross-check - value must be less than VOUT_MARGIN_HIGH value.

VOUT_DROOP [0x28]

Factory default: 0 (No droop); 14.3 (Parallel operation)

Range limits (max/min): 50/0

Units: mv/A

Command support: All functionality

VIN_ON [0x35]

Range limits (max/min): 46/33

Units: volt

Command support: All functionality

Note: Special interlock checks between VIN_ON and VIN_OFF maintain a hysteresis gap of 2V minimum and do not allow the OFF level to be higher than and ON level

VIN_OFF [0x36]

Range limits (max/min): 46/33

Units: volt

Command support: All functionality

Note: Special interlock checks between VIN_ON and VIN_OFF maintain a hysteresis gap of 2V minimum and do not allow the OFF level to be higher than and ON level

VOUT_OV_FAULT_LIMIT [0x40]

Range limits (max/min): 15.99/10.90 (See note 1, 2)

Units: volt

Command support: All functionality

Note: 1. Range cross-check - value must be greater than VOUT_COMMAND value.

2. The module's internal maximum OV Fault Limit equals the VOUT_COMMAND plus 3.99V, up to 15.99V. This is an automatic module protection feature that will override a user-set VOUT_OV_FAULT_LIMIT, if the user limit is set too high. The internal OV Fault limit value is not visible to the user via PMBus.

VOUT_OV_FAULT_RESPONSE [0x41]

Command support:

- Response settings (bits RSP0:1) – only a setting of 10, unit shuts down and responds according to the retry settings below, is supported.
- Retry settings (bits RS0:2) – only settings of 000 (unit does not attempt to restart on fault) and 111 unit continuously restarts (normal startup) while fault is present until commanded off, bias power is removed or another fault condition causes the unit to shutdown.
- Delay time setting (bits DT0:2) – only DT0:2 = 0 (no delay) supported.

Default Settings: The default settings for the VOUT_OV_FAULT_RESPONSE command are;

- The unit shuts down in response to a VOUT over voltage condition.
- The unit will continuously restart (normal startup) while the VOUT over voltage condition is present until it is commanded off, bias power is removed or another fault condition causes the unit to shutdown.
- The shutdown delay is set to 0 delay cycles.

Format	8 bit unsigned (bit field)							
Bit Position	7	6	5	4	3	2	1	0
Access	r	r	r/w	r/w	r/w	r	r	r
Function	RSP[1]	RSP[0]	RS[2]	RS[1]	RS[0]	DT[2]	DT[1]	DT[0]
Default Value	1	0	1	1	1	0	0	0

QSDW035A0B Series Power Modules; DC-DC Converters

36Vdc –75Vdc Input; 12Vdc Output; 35A Output Current

IOUT_OC_FAULT_LIMIT [0x46]

Range limits (max/min): 50/15

Units: amp

Command support: All functionality

Note: Range cross-check – value must be greater than IOUT_OC_WARN_LIMIT value.

IOUT_OC_FAULT_RESPONSE [0x47]

Command support:

- Response settings (bits RSP0:1) – only settings of 11, unit shuts down and responds according to the retry settings below, is supported.
- Retry settings (bits RS0:2) – only settings of 000 (unit does not attempt to restart on fault) and 111 unit continuously restarts (normal startup) while fault is present until commanded off, bias power is removed or another fault condition causes the unit to shutdown.
- Delay time setting (bits DT0:2) – only DT0:2 = 0 (no delay) supported.

Default Settings: The default settings for the IOUT_OC_FAULT_RESPONSE command are;

- The unit shuts down in response to an IOUT over current condition.
- The unit will continuously restart (normal startup) while the IOUT over current condition is present until it is commanded off, bias power is removed or another fault condition causes the unit to shutdown.
- The shutdown delay is set to 0 delay cycles.

Format	8 bit unsigned (bit field)							
Bit Position	7	6	5	4	3	2	1	0
Access	r	r	r/w	r/w	r/w	r	r	r
Function	RSP[1]	RSP[0]	RS[2]	RS[1]	RS[0]	DT[2]	DT[1]	DT[0]
Default Value	1	1	1	1	1	0	0	0

IOUT_OC_WARN_LIMIT [0x4A]

Range limits (max/min): 40/8

Units: amp

Command support: read/write support, functionality complete

Note: Range cross-check – value must be less than IOUT_OC_FAULT_LIMIT value.

OT_FAULT_LIMIT [0x4F]

Range limits (max/min): 140/25

Units: degrees C.

Command support: All functionality

Note: Range cross-check – value must be greater than OT_WARN_LIMIT value.

OT_FAULT_RESPONSE [0x50]

Command support:

- Response settings (bits RSP0:1) – only setting of 10, unit shuts down and responds according to the retry settings below.
- Retry settings (bits RS0:2) – only settings of 000 (unit does not attempt to restart on fault) and 111 unit continuously restarts (normal startup) while fault is present until commanded off, bias power is removed or another fault condition causes the unit to shutdown.
- Delay time setting (bits DT0:2) – only DT0:2 = 0 (no delay) supported.

Default Settings: The default settings for the OT_FAULT_RESPONSE command are;

- The unit shuts down in response to an over-temperature condition.
- The unit will continuously restart (normal startup) while the over-temperature condition is present until it is commanded off, bias power is removed or another fault condition causes the unit to shutdown.
- The shutdown delay is set to 0 delay cycles.

Format	8 bit unsigned (bit field)							
Bit Position	7	6	5	4	3	2	1	0
Access	r	r	r/w	r/w	r/w	r	r	r
Function	RSP[1]	RSP[0]	RS[2]	RS[1]	RS[0]	DT[2]	DT[1]	DT[0]
Default Value	1	0	1	1	1	0	0	0

QSDW035A0B Series Power Modules; DC-DC Converters

36Vdc –75Vdc Input; 12Vdc Output; 35A Output Current

OT_WARN_LIMIT [0x51]

Range limits (max/min): 125/25
 Units: degrees C.
 Command support: All functionality
 Note: Range cross-check – value must be less than OT_FAULT_LIMIT value.

VIN_OV_FAULT_LIMIT [0x55]

Range limits (max/min): 90/48
 Units: volt
 Command support: All functionality

VIN_OV_FAULT_RESPONSE [0x56]

Command support:
 Response settings (bits RSP0:1) – only settings of 11 (The device’s output is disabled while the fault is present.) is supported.
 - Retry settings (bits RS0:2) – only settings of 000 (unit does not attempt to restart on fault).
 - Delay time setting (bits 0-2) – only DT0:2 = 0 (no delay) supported.
 Default Settings: The default settings for the VIN_OV_FAULT_RESPONSE command are;
 - The unit shuts down in response to a VIN over voltage condition.
 - The unit will continuously prepares to restart (normal startup) while the VIN over voltage condition is present until it is commanded off, bias power is removed, the VIN over voltage condition is removed, or another fault condition causes the unit to shutdown.
 - The shutdown delay is set to 0 delay cycles.

Format	8 bit unsigned (bit field)							
Bit Position	7	6	5	4	3	2	1	0
Access	r	r	r	r	r	r	r	r
Function	RSP[1]	RSP[0]	RS[2]	RS[1]	RS[0]	DT[2]	DT[1]	DT[0]
Default Value	1	1	0	0	0	0	0	0

POWER_GOOD_ON [0x5E]

Range limits (max/min): 13.2/3.0
 Units: volt
 Command support: full support
 Note: Range cross-check – value must be greater than POWER_GOOD_OFF value by 0.5V.

POWER_GOOD_OFF [0x5F]

Range limits (max/min): 13.2/3.0
 Units: volt
 Command support: full support
 Note: Range cross-check – value must be less than POWER_GOOD_ON value by 0.5V.

TON_DELAY [0x60]

Range limits (max/min): 500/0
 Units: milliseconds
 Command support: full support

TON_RISE [0x61]

Range limits (max/min): 500/15
 Units: milliseconds
 Command support: full support

STATUS_WORD [0x79]

Command support: full implementation for supported functions (note: Fans, MFR_SPECIFIC, Unknown not supported)

Format	8 bit unsigned (bit field)							
Bit Position	15	14	13	12	11	10	9	8
Access	r	r	r	r	r	r	r	r
Function	VOUT	I/POUT	INPUT	MFR_SPEC ¹	#PWR_GOOD	FANS ¹	OTHER ¹	UN KNOWN ¹

Format	8 bit unsigned (bit field)							
Bit Position	7	6	5	4	3	2	1	0

QSDW035A0B Series Power Modules; DC-DC Converters
36Vdc –75Vdc Input; 12Vdc Output; 35A Output Current

Access	r	r	r	r	r	r	r	r
Function	BUSV ¹	OUTPUT _OFF	VOUT_O V_FAULT	IOUT_OC_FAULT	VIN_UV _FAULT	TEMP	CML	NONE OF ABOVE ¹

(1) Not supported

STATUS_VOUT [0x7A]

Command support: VOUT_OV_FAULT support, all bit reset supported

Format	8 bit unsigned (bit field)							
Bit Position	7	6	5	4	3	2	1	0
Access	r/reset(1)	r/ reset	r/ reset	r/ reset	r/ reset	r/ reset	r/ reset	r/ reset
Function	VOUT_OV _FAULT	VOUT_OV _WARN ¹	VOUT_UV _WARN ¹	VOUT_UV _FAULT ¹	VOUT_ MAX _WARN ¹	TON_ MAX_ FAULT ¹	TOFF_ MAX_ WARN ¹	VOUT TRACKING ERROR ¹

(1) Not supported

STATUS_IOUT [0x7B]

Command support: IOUT_OC_FAULT support, all bit reset supported

Format	8 bit unsigned (bit field)							
Bit Position	7	6	5	4	3	2	1	0
Access	r/ reset(1)	r/ reset	r/ reset	r/ reset	r/ reset	r/ reset	r/ reset	r/ reset
Function	IOUT_OC _FAULT	IOUT_OC_LV _FAULT ¹	IOUT_OC _WARN	IOUT_UC _FAULT ¹	Current Share Fault ¹	In Power Limiting Mode ¹	POUT_OP _FAULT ¹	POUT_OP _WARN ¹

(1) Not supported

STATUS_INPUT [0x7C]

Command support: VIN_OV_FAULT support, all bit reset supported

Format	8 bit unsigned (bit field)							
Bit Position	7	6	5	4	3	2	1	0
Access	r/ reset(1)	r/ reset	r/ reset	r/ reset	r/ reset	r/ reset	r/ reset	r/ reset
Function	VIN_OV _FAULT	VIN_OV _WARN ¹	VIN_UV _WARN ¹	VIN_UV _FAULT	Unit Off (low input voltage)	IIN_OC _FAULT ¹	IIN_OC _WARN ¹	PIN_OP _WARN ¹

(1) Not supported

STATUS_TEMPERATURE [0x7D]

Command support: OT_WARN, OT_FAULT supported, all bit reset supported

Format	8 bit unsigned (bit field)							
Bit Position	7	6	5	4	3	2	1	0
Access	r/ reset(1)	r/ reset	r/ reset	r/ reset	r/ reset	r/ reset	r/ reset	r/ reset
Function	OT_FAULT	OT_WARN	UT_ WARN ¹	UT_ FAULT ¹	reserved	reserved	reserved	reserved

(1) Not supported

QSDW035A0B Series Power Modules; DC-DC Converters
 36Vdc –75Vdc Input; 12Vdc Output; 35A Output Current

STATUS_CML [0x7E]

Command support: PEC_FAULT, INVALID_DATA, INVALID_CMD supported, all bit reset supported

Format	8 bit unsigned (bit field)							
Bit Position	7	6	5	4	3	2	1	0
Access	r/ reset(1)	r/ reset	r/ reset	r/ reset	r/ reset	r/ reset	r/ reset	r/ reset
Function	INVALID CMD	INVALID DATA	PEC FAILED	MEMORY FAULT ¹	PROC FAULT ¹	reserved	COM FAULT (other) ¹	Memory/ Logic fault (other) ¹

(1) Not supported

READ_VIN [0x88]

Command support: full support

READ_VOUT [0x8B]

Command support: full support

READ_IOUT [0x8C]

Command support: full support

READ_TEMPERATURE_1 [0x8D]

Command support: full support

MFR_DEVICE_TYPE [0xD0]

Command support: partial support in place (Mod Name)

Format	Unsigned Binary																
Bit Pos.	7	6	5	4	3	2	1	0	7	6	5	4	3	2	1	0	
Access	r/w	r/w	r/w	r/w	r/w	r	r	r	r/w	r/w	r/w	r/w	r/w	r/w	r/w	r/w	
Function	Reserved								Module Name							WPE	Res
Default	0	0	0	0	0	0	0	0	1	0	0	0	0	0	0	1	0

Byte	Bit	Description	Value	Meaning
High Byte	7:0	Reserved		
Low Byte	7:2	Module Name ¹	1xxxxx	Module Name
	1	WPE	0	Write Protect Enable not active.
			1	Write Protect Enable active.
	0	Reserved	0	Reserved

1. Present module designations (Non-isolated units will have a 0XXXXX format)
 QSDW035A0B4xxx: 100110

MFR_VOUT_READ_CAL_GAIN [0xD1]

Factory default: 0x2000

Range limits (max/min): 0x2666/0x1999

Units: N/A

Command support: support for VOUT gain calibration (factor in flash), lockout per MFR_DEVICE_TYPE

MFR_VOUT_READ_CAL_OFFSET [0xD2]

Range limits (max/min): exp must = -12

Units: N/A

Command support: support for VOUT offset calibration (factor in flash), lockout per MFR_DEVICE_TYPE

MFR_VIN_READ_CAL_GAIN [0xD3]

Factory default: 0x2000

Range limits (max/min): 0x2666/0x1999

Command support: support for VIN gain calibration (factor in flash), lockout per MFR_DEVICE_TYPE

QSDW035A0B Series Power Modules; DC-DC Converters

36Vdc –75Vdc Input; 12Vdc Output; 35A Output Current

MFR_VIN_READ_CAL_OFFSET [0xD4]

Data format: VIN linear format

Range limits (max/min): exp must = -3

Units: N/A

Command support: support for VIN offset calibration (factor in flash), lockout per MFR_DEVICE_TYPE

MFR_IOUT_CAL_GAIN [0xD6]

Range limits (max/min): 0x2666/0x1999

Units: N/A

Command support: support for IOUT gain calibration, lockout per MFR_DEVICE_TYPE

MFR_IOUT_CAL_OFFSET [0xD7]

Range limits (max/min): exp must = -4

Units: N/A

Command support: support for IOUT offset calibration, lockout per MFR_DEVICE_TYPE

MFR_FW_REV [0xDB]

Range limits (max/min): 0 - 0xff (0.00 – 15.15)

Units: N/A

Command support: full read support

MFR_C1_C2_ARA_CONFIG [0xE0]

Command Code

Command support: Full support.

The module must be configured with ENABLE_OFF when C1/C2 is being reconfigured.

Command	MFR_C1_C2_ARA_CONFIG							
Format	8 bit unsigned (bit field)							
Bit Position	7	6	5	4	3	2	1	0
Access	r	r	r	r/w	r/w	r/w	r/w	r/w
Function	Reserved			ARA	Assignment Table			
Default Value	0	0	0	0	0	0	0	0

Bit	Description	Value	Meaning
7:5	Reserved	000	Reserved
4	ARA	0	ARA not functional, module remains at resistor programmed address when SMBLAERT is asserted
		1	ARA functional, module responds to ARA only, when SMBLAERT is asserted
3:0	PIN Configuration*	0000	T/C1 pin: ON/OFF (Secondary) C2 pin: POWER_GOOD
		0001	T/C1 pin: TRIM C2 pin: POWER_GOOD
		0010	T/C1 pin: TRIM C2 pin: ON/OFF (Secondary)

* All QBDW without -P option

Bit	Description	Value	Meaning
7:5	Reserved	000	Reserved
4	ARA	0	ARA not functional, module remains at resistor programmed address when SMBLAERT is asserted
		1	ARA functional, module responds to ARA only, when SMBLAERT is asserted
3:0	PIN Configuration**	0000	T/C1 pin: ON/OFF (Secondary) C2 pin: POWER_GOOD

** All QBDW with -P option

QSDW035A0B Series Power Modules; DC-DC Converters

36Vdc –75Vdc Input; 12Vdc Output; 35A Output Current

MFR_C2_LOGIC [0xE1]

Command Code

Command support: full support (bits 0 and 1) as follows:

Command	MFR_C2_LOGIC								
Format	8 bit unsigned (bit field)								
Bit Position	7	6	5	4	3	2	1	0	
Access	r	r	r	r	r	r	r/w	r/w	
Function	Reserved						On/Off(primary & secondary) combination		logic
Default Value	0	0	0	0	0	0	0	0	

Bit	Description	Value	Meaning
7:2	Reserved	000000	Reserved
1	ON/OFF Configuration	0	Secondary side on/off pin state when mapped to either T/C1 or C2 is ignored
		1	AND – Primary and Secondary side on/off
0	Secondary Side ON/OFF Logic	0	Negative Logic (Low Enable: Input < 0.8V wrt Vout(-)
		1	Positive Logic (High Enable: Input > 2.0V wrt Vout(-)

MFR_PGOOD_POLARITY [0xE2]

Command support: full support (bit 0) as follows:

Bit 0: 0 = Negative PGOOD logic (module PGOOD asserted when pin is LO, PGOOD de-asserted when pin is HI)

1 = Positive PGOOD logic (module PGOOD de-asserted when pin is LO, PGOOD asserted when pin is HI)

Command	MFR_PGOOD_POLARITY							
Format	8 bit unsigned (bit field)							
Bit Position	7	6	5	4	3	2	1	0
Access	r	r	r	r	r	r	r	r/w
Function	Reserved							logic
Default Value	0	0	0	0	0	0	0	1

MFR_MODULE_DATE_LOC_SN [0xF0]

Command support: read/write support for 12 byte block, lockout per MFR_DEVICE_TYPE

QSDW035A0B Series Power Modules; DC-DC Converters

36Vdc –75Vdc Input; 12Vdc Output; 35A Output Current

PMBus Command Quick Reference Table

PMBUS CMD	CMD CODE	DATA BYTES	DATA FORMAT	DATA UNITS	TRANSFER TYPE	DEFAULT VALUE
OPERATION	0x01	1	Bit field	N/A	R/W byte	0x80
ON_OFF_CONFIG	0x02	1	Bit field	N/A	R/W byte	0x1D (Neg Logic) 0x1F (Pos Logic)
CLEAR_FAULTS	0x03	0	N/A	N/A	Send byte	none
STORE_DEFAULT_ALL	0x11	0	N/A	N/A	Send byte	none
RESTORE_DEFAULT_ALL	0x12	0	N/A	N/A	Send byte	none
VOUT_MODE	0x20	1	mode + exp	N/A	Read byte	0x14
VOUT_COMMAND	0x21	2	VOUT linear	Volts	R/W word	12.000V (Std code)
VOUT_CAL_OFFSET	0x23	2	VOUT linear	Volts	R/W word	MS
VOUT_MARGIN_HIGH	0x25	2	VOUT linear	Volts	R/W word	12.600V
VOUT_MARGIN_LOW	0x26	2	VOUT linear	Volts	R/W word	11.400V
VOUT_DROOP	0x28	2	VOUT linear	mV/A	R/W word	0
VIN_ON	0x35	2	VIN linear	v	R/W word	35.000V
VIN_OFF	0x36	2	VIN linear	v	R/W word	33.000V
VOUT_OV_FAULT_LIMIT	0x40	2	VOUT linear	v	R/W word	15.990V
VOUT_OV_FAULT_RESPONSE	0x41	1	Bit field	N/A	R/W byte	0xB8
IOUT_OC_FAULT_LIMIT	0x46	2	IOUT linear	Amps	R/W word	42.000A
IOUT_OC_FAULT_RESPONSE	0x47	1	Bit field	N/A	R/W byte	0xF8
IOUT_OC_WARN_LIMIT	0x4A	2	IOUT linear	Amps	R/W word	38.500A
OT_FAULT_LIMIT	0x4F	2	TEMP linear	Deg. C	R/W word	135C
OT_FAULT_RESPONSE	0x50	1	Bit field	N/A	R/W byte	0xB8
OT_WARN_LIMIT	0x51	2	TEMP linear	Deg. C	R/W word	125C
VIN_OV_FAULT_LIMIT	0x55	2	VIN linear	v	R/W word	85V
VIN_OV_FAULT_RESPONSE	0x56	1	Bit field	N/A	R/W byte	0xC0
POWER_GOOD_ON	0x5E	2	VOUT linear	v	R/W word	10.100V
POWER_GOOD_OFF	0x5F	2	VOUT linear	v	R/W word	8.500V
TON_DELAY	0x60	2	Time linear	msec	R/W word	2ms
TON_RISE	0x61	2	Time linear	msec	R/W word	25ms
STATUS_WORD	0x79	2	Bit field	N/A	Read word	N/A
STATUS_VOUT	0x7A	1	Bit field	N/A	Read byte	N/A
STATUS_IOUT	0x7B	1	Bit field	N/A	Read byte	N/A
STATUS_INPUT	0x7C	1	Bit field	N/A	Read byte	N/A
STATUS_TEMPERATURE	0x7D	1	Bit field	N/A	Read byte	N/A
STATUS_CML	0x7E	1	Bit field	N/A	Read byte	N/A
READ_VIN	0x88	2	VIN linear	v	Read word	N/A
READ_VOUT	0x8B	2	VOUT linear	v	Read word	N/A
READ_IOUT	0x8C	2	IOUT linear	Amps	Read word	N/A
READ_TEMP1	0x8D	2	TEMP linear	Deg. C	Read word	N/A
PMBUS_REVISION	0x98	1	Bit Field	n/a	Read byte	1.2
MFR_DEVICE_TYPE	0xD0	2	Custom	N/A	R/W word	0x009A
MFR_VOUT_READ_CAL_GAIN	0xD1	2	16 bit unsigned	N/A	R/W word	0x2000
MFR_VOUT_READ_CAL_OFF	0xD2	2	VOUT linear	N/A	R/W word	MS
MFR_VIN_READ_CAL_GAIN	0xD3	2	16 bit unsigned	N/A	R/W word	MS
MFR_VIN_READ_CAL_OFF	0xD4	2	VIN linear	N/A	R/W word	MS
MFR_IOUT_CAL_GAIN	0xD6	2	16 bit unsigned	N/A	R/W word	MS
MFR_IOUT_CAL_OFFSET	0xD7	2	IOUT linear	N/A	R/W word	MS
MFR_FW_REV	0xDB	2	8 bit unsigned	N/A	Read byte	0xMj.Mn.Bh.Bl
MFR_C1_C2_ARA_CONFIG	0xE0	1	Bit field	N/A	R/W byte	0x00
MFR_C2_LOGIC	0xE1	1	Bit field	N/A	R/W byte	0x00
MFR_PGOOD_POLARITY	0xE2	1	Bit field	N/A	R/W byte	0x01
MFR_MOD_DATE_LOC_SN	0xF0	12	8 bit char	N/A	R/W block	YYLLWW123456

MS=Module specific

QSDW035A0B Series Power Modules; DC-DC Converters

36Vdc – 75Vdc Input; 12Vdc Output; 35A Output Current

EMC Considerations

The circuit and plots in Figure 25 show a suggested configuration to meet the conducted emission limits of EN55022 Class A. For further information on designing for EMC compliance, please refer to the FLT012A0Z data sheet.

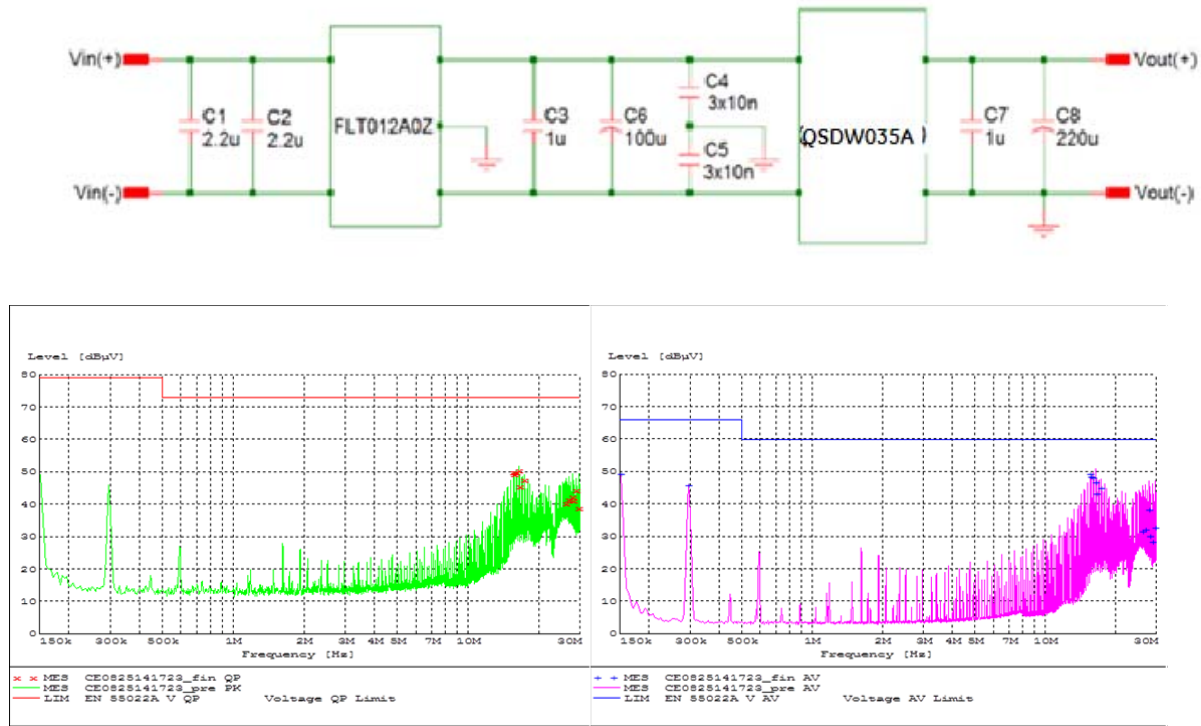

Figure 25. EMC Consideration

QSDW035A0B Series Power Modules; DC-DC Converters

36Vdc –75Vdc Input; 12Vdc Output; 35A Output Current

Packaging Details

All versions of the QSDW035A0B are supplied as standard in the plastic trays shown in Figure 26. Each tray contains a total of 12 power modules. The trays are self-stacking and each shipping box for the QSDW035A0B module contains 2 full trays plus one empty hold-down tray giving a total number of 24 power modules.

Tray Specification

Material	PET (1mm)
Max surface resistivity	$10^9 - 10^{11} \Omega/\text{PET}$
Color	Clear
Capacity	12 power modules
Min order quantity	24 pcs (1 box of 2 full trays + 1 empty top tray)

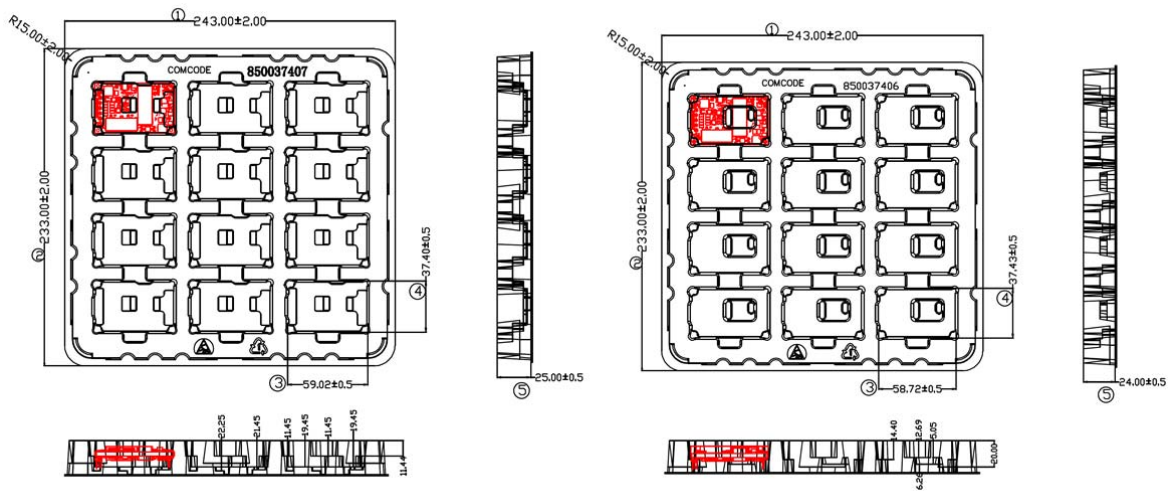

Open Frame Module Tray

Base Plate Module Tray

Figure 26. QSDW035 Packaging Tray

QSDW035A0B Series Power Modules; DC-DC Converters

36Vdc –75Vdc Input; 12Vdc Output; 35A Output Current

Mechanical Outline for QSDW035A0B Through-hole Module

Dimensions are in millimeters and [inches].

Tolerances: x.x mm ± 0.5 mm [x.xx in. ± 0.02 in.] (Unless otherwise indicated)

x.xx mm ± 0.25 mm [x.xxx in ± 0.010 in.]

*Top side label includes GE name, product designation, and data code.

** Standard pin tail length. Optional pin tail lengths shown in Table 2, Device Options.

TOP VIEW*

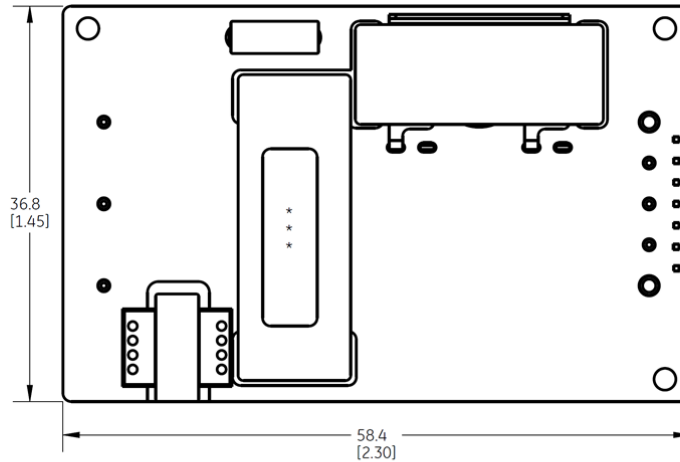

SIDE VIEW

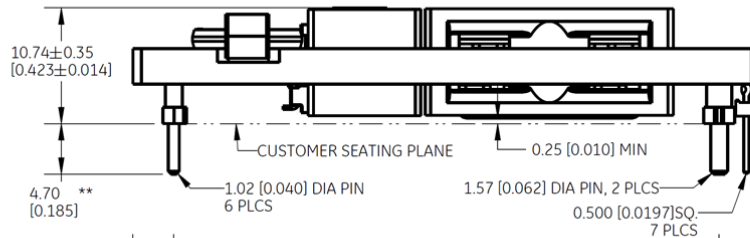

BOTTOM VIEW

Pin Number	Pin Name
1	VIN(+)
2	ON/OFF
3	VIN(-)
4	VOUT(-)
5	SENSE(-)
6	TRIM/C1
7	SENSE(+)
8	VOUT(+)
9	C2
10	SIG_GND
11	DATA
12	SMBALERT
13	CLK
14	ADDR1
15	ADDR0

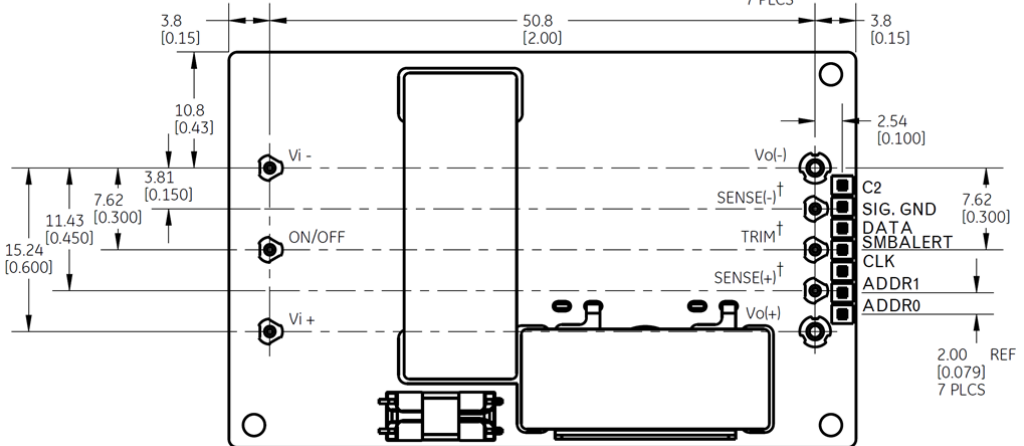

QSDW035A0B Series Power Modules; DC-DC Converters

36Vdc –75Vdc Input; 12Vdc Output; 35A Output Current

Mechanical Outline for QSDW035A0B–H (Baseplate version) Module

Dimensions are in millimeters and [inches].

Tolerances: x.x mm ± 0.5 mm [x.xx in. ± 0.02 in.] (Unless otherwise indicated)

x.xx mm ± 0.25 mm [x.xxx in ± 0.010 in.]

*Top side label includes GE name, product designation, and data code.

** Standard pin tail length. Optional pin tail lengths shown in Table 2, Device Options.

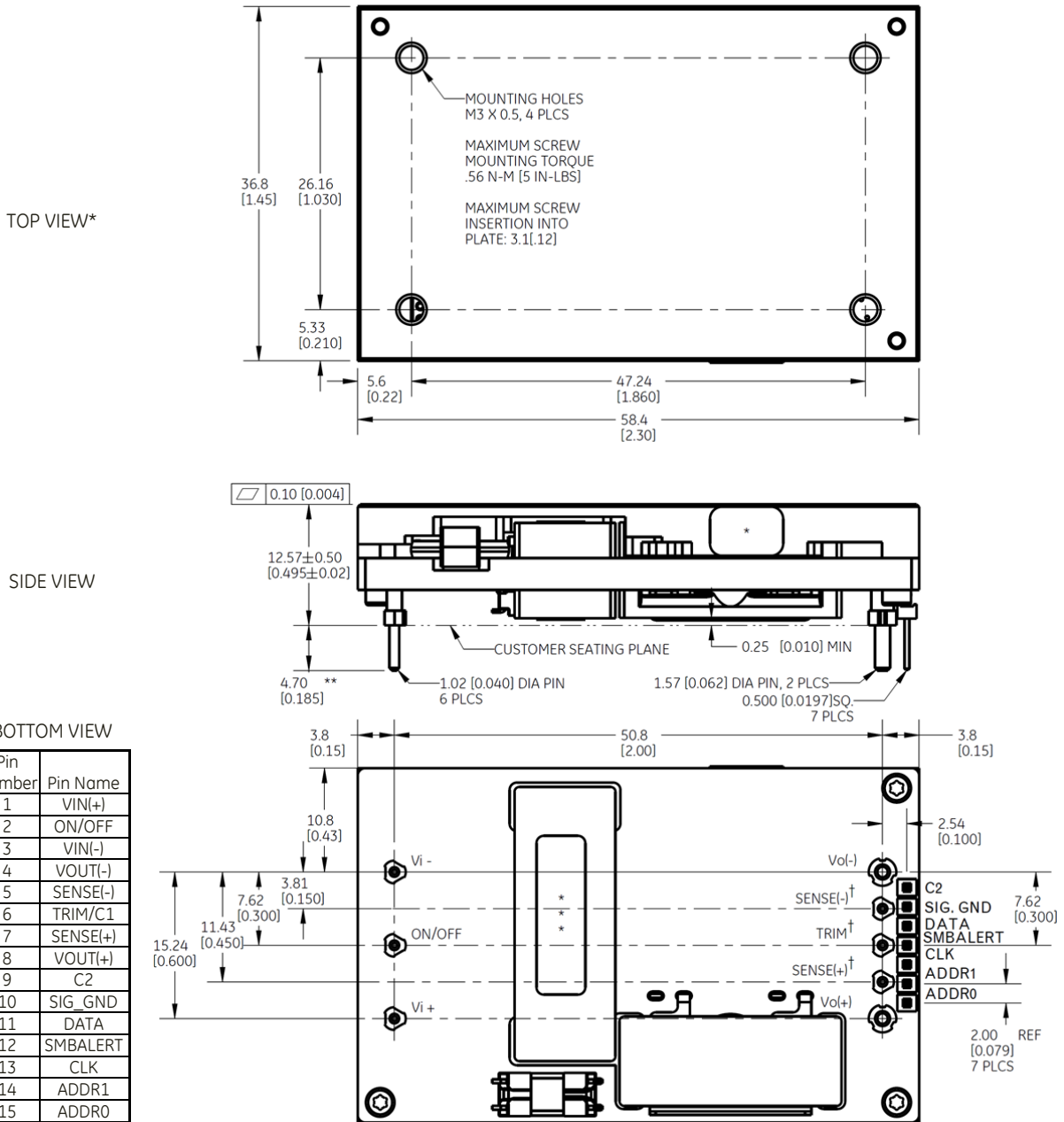

QSDW035A0B Series Power Modules; DC-DC Converters

36Vdc –75Vdc Input; 12Vdc Output; 35A Output Current

Recommended Pad Layouts

Dimensions are in millimeters and [inches].
 Tolerances: x.x mm ± 0.5 mm [x.xx in. ± 0.02 in.] (unless otherwise indicated)
 x.xx mm ± 0.25 mm [x.xxx in ± 0.010 in.]

Through-Hole Modules for use with wave soldering

Pin Number	Pin Name
1	VIN(+)
2	ON/OFF
3	VIN(-)
4	VOUT(-)
5	SENSE(-)
6	TRIM/C1
7	SENSE(+)
8	VOUT(+)
9	C2
10	SIG_GND
11	DATA
12	SMBALERT
13	CLK
14	ADDR1
15	ADDR0

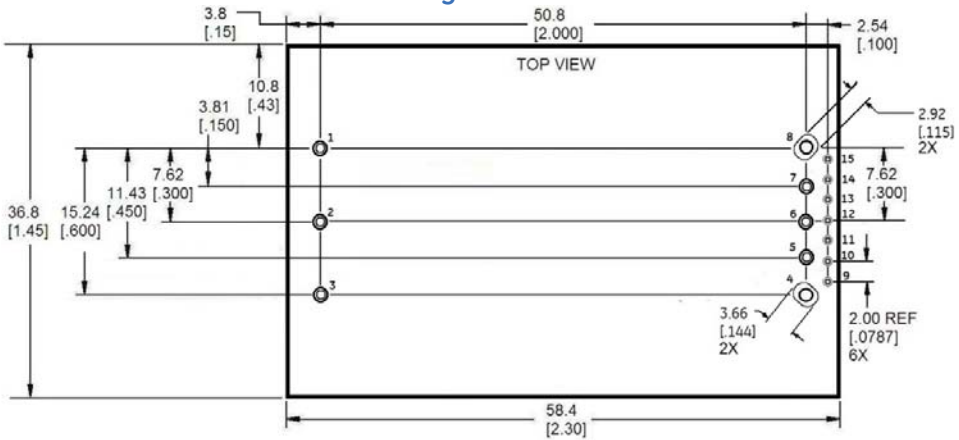

Hole and Pad diameter recommendation:

Pin Number	Hole Dia mm [in]	Pad Dia mm [in]
1, 2, 3, 5, 6, 7	1.6 [0.063]	2.1 [0.083]
9, 10, 11, 12, 13, 14, 15	1.0 [0.039]	1.5 [0.059]
4, 8	Oval land having 45 degrees rotation with plated slots 2.3 mm x 3.05 mm (with top and bottom pad of 2.92 x 3.66 mm)	

Through-Hole Modules for use with hand, selective or reflow soldering

Pin Number	Pin Name
1	VIN(+)
2	ON/OFF
3	VIN(-)
4	VOUT(-)
5	SENSE(-)
6	TRIM/C1
7	SENSE(+)
8	VOUT(+)
9	C2
10	SIG_GND
11	DATA
12	SMBALERT
13	CLK
14	ADDR1
15	ADDR0

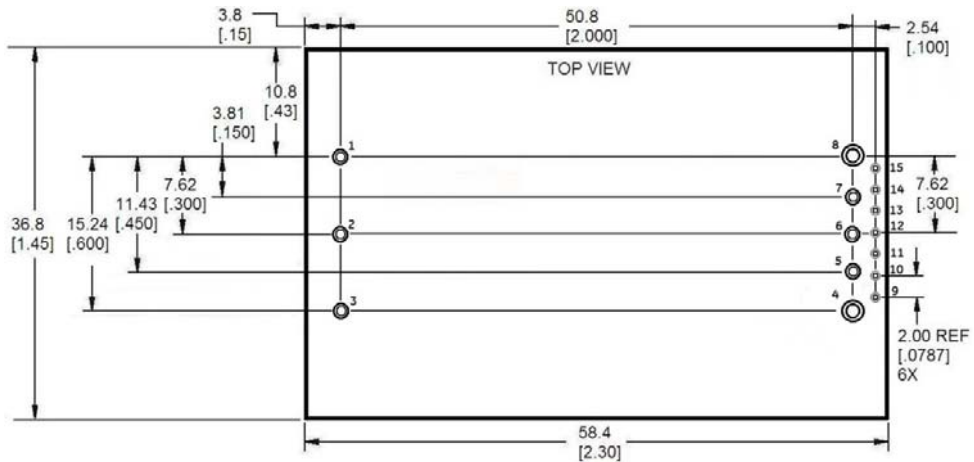

Hole and Pad diameter recommendation:

Pin Number	Hole Dia mm [in]	Pad Dia mm [in]
1, 2, 3, 5, 6, 7	1.6 [0.063]	2.1 [0.083]
9, 10, 11, 12, 13, 14, 15	1.0 [0.039]	1.5 [0.059]
4, 8	2.0 [0.078]	3.2 [0.126]

QSDW035A0B Series Power Modules; DC-DC Converters

36Vdc –75Vdc Input; 12Vdc Output; 35A Output Current

Ordering Information

Please contact your GE Sales Representative for pricing, availability and optional features.

Table 1. Device Codes

Product codes	Input Voltage	Output Voltage	Output Current	Efficiency	MSL Rating	Connector Type	Comcodes
QSDW035A0B41Z	48V (36 -75Vdc)	12V	35A	95.5%	2a	Through Hole	150032022
QSDW035A0B41-HZ	48V (36 -75Vdc)	12V	35A	95.5%	2a	Through Hole	150032026

Table 2. Device Options

	Characteristic	Character and Position	Definition
Ratings	Form Factor	Q	Q = Quarter Brick
	Family Designator	SD	SD = BARRACUDA Series with PMBus Interface
	Input Voltage	W	W = Wide Range, 48/52/54V (36V-75V)
	Output Power	035A0	035A0 = 035.0 Amps Maximum Output Current
	Output Voltage	B	B = 12.0V nominal
Options	Pin Length	8 6	Omit = Default Pin Length shown in Mechanical Outline Figures 8 = Pin Length: 2.79 mm ± 0.25mm , (0.110 in. ± 0.010 in.) 6 = Pin Length: 3.68 mm ± 0.25mm , (0.145 in. ± 0.010 in.)
	Action following Protective Shutdown	4	Omit = Latching Mode 4 = Auto-restart following shutdown (Overcurrent/Overvoltage)
	On/Off Logic	1	Omit = Positive Logic 1 = Negative Logic
	Customer Specific	XY	XY = Customer Specific Modified Code, Omit for Standard Code
	Maximum Output Cap	Q	Q = Increased Maximum External Output Capacitance
	Load Share	P	P = Forced Droop Output for use in parallel applications
	Features	H	H = Heat plate, for use with heat sinks or cold-walls
	RoHS	Z	Z = RoHS 6/6 Compliant, Lead free

Contact Us

For more information, call us at

USA/Canada:

+1 888 546 3243, or +1 972 244 9288

Asia-Pacific:

+86.021.54279977*808

Europe, Middle-East and Africa:

+49.89.878067-280

www.gecriticalpower.com



GE Critical Power reserves the right to make changes to the product(s) or information contained herein without notice, and no liability is assumed as a result of their use or application. No rights under any patent accompany the sale of any such product(s) or information.