

# Datasheet

BL652-SA and BL652-SC

*Version 2.2*

---

## REVISION HISTORY

Version	Date	Notes	Approver
1.0	20 July 2016	Initial Release	Jonathan Kaye
1.1	30 Aug 2016	Corrected Operating Temperature voltage to read VCC 1.8 V-3.6 V rather than 1.7 V-3.6V Corrected minor formatting issues and typo Changed the SIO_02 pin # (OTA mode table) to 23 vs. 21	Raj Khatri
1.2	02 Sept 2016	Added missing BT SIG info Updated Declaration of Conformity Added text to Note 1 of Pin Definition Notes Fixed error in Note 13 of Pin Definition Notes	Jonathan Kaye/ Raj Khatri
1.3	14 Sept 2016	Updated BT SIG section	Jonathan Kaye
1.4	14 Oct 2016	Updates to JTAG Signals and wiring	Raj Khatri
1.5	15 Nov 2016	Fix SIO_12 reference to SIO_02 in <a href="#">vSP Command Mode</a>	Raj Khatri
1.6	14 Feb 2017	Fixed UART Interface pins in <a href="#">Table 20</a>	Mark Duncombe
1.7	06 Mar 2017	Updated Standby Doze references from 1.2 uA to 2.0 uA	Raj Khatri
1.8	29 June 2017	Added X-Y-Z indication to Updated DoC with new RED standards	Raj Khatri
1.9	28 July 2017	Updated Ble_avg calculation in section <a href="#">4.2 Measured Current Waveforms during Advertising and Connection</a>	Raj Khatri
2.0	18 Sept 2017	Updated tables 21, 22, and 23 to include SIO pins	Raj Khatri
2.1	10 Oct 2017	Added the mFlexPIFA antenna information	Bill Steinike
2.2	23 Oct 2017	Changed all BT4.2 references to BTv5.0 Updated the BT SIG section	Jonathan Kaye

## CONTENTS

1	Overview and Key Features .....	5
1.1	Features and Benefits .....	5
1.2	Application Areas .....	5
2	Specification .....	6
2.1	Specification Summary .....	6
3	Hardware Specifications .....	10
3.1	Block Diagram and Pin-out .....	10
3.2	Pin Definitions .....	11
3.3	Electrical Specifications .....	16
3.3.1	Absolute Maximum Ratings .....	16
3.3.2	Recommended Operating Parameters .....	17
3.3.3	nAutoRUN Pin and Operating Modes .....	19
3.3.4	OTA (Over-the-Air) smartBASIC Application Download .....	19
4	Power Consumption .....	20
4.1	Power Consumption .....	20
4.2	Measured Current Waveforms during Advertising and Connection .....	22
4.3	Peripheral Block Current Consumption .....	34
5	Functional Description .....	35
5.1	Power Management (includes Brown-out and Power on Reset) .....	35
5.2	Clocks and Timers .....	36
5.2.1	Clocks .....	36
5.2.2	Timers .....	36
5.3	Memory for smartBASIC Application Code .....	36
5.4	Radio Frequency (RF) .....	36
5.5	NFC .....	36
5.5.1	Use Cases .....	37
5.6	UART Interface .....	37
5.7	SPI Bus .....	38
5.8	I2C Interface .....	38
5.9	General Purpose I/O, ADC, PWM and FREQ .....	39
5.9.1	GPIO .....	39
5.9.2	ADC .....	39
5.9.3	PWM Signal Output on up to 12 SIO Pins .....	40
5.9.4	FREQ Signal Output on up to 2 SIO Pins .....	40
5.10	nRESET pin .....	40
5.11	nAutoRUN pin .....	40
5.12	vSP Command Mode .....	40
5.13	Two-wire Interface JTAG .....	41
5.14	BL652 Wakeup .....	43
5.14.1	Waking Up BL652 from Host .....	43
5.15	Low Power Modes .....	43
5.16	Temperature Sensor .....	43
5.17	Random Number Generator .....	44
5.18	AES Encryption/Decryption .....	44
5.19	Optional External Serial (SPI) Flash .....	44

5.20	Optional External 32.768 kHz crystal .....	44
5.21	BL652-SA On-board Chip Antenna Characteristics .....	46
6	Hardware Integration Suggestions .....	47
6.1	Circuit .....	47
6.2	PCB Layout on Host PCB - General .....	49
6.3	PCB Layout on Host PCB for BL652-SA .....	50
6.3.1	Antenna Keep-out on Host PCB .....	50
6.3.2	Antenna Keep-out and Proximity to Metal or Plastic .....	51
6.4	External Antenna Integration with BL652-SC .....	52
7	Mechanical Details .....	53
7.1	BL652 Mechanical Details .....	53
7.2	Host PCB Land Pattern and Antenna Keep-out for BL652-SA .....	54
8	Application Note for Surface Mount Modules .....	55
8.1	Introduction .....	55
8.2	Shipping .....	55
8.2.1	Tape and Reel Package Information .....	55
8.2.2	Carton Contents .....	56
8.2.3	Packaging Process .....	57
8.2.4	Labeling .....	57
8.3	Reflow Parameters .....	58
9	FCC and IC Regulatory Statements .....	60
9.1	Antenna Information .....	60
9.2	Power Exposure Information .....	61
9.3	OEM Responsibilities .....	61
9.4	Federal Communication Commission Interference Statement .....	61
9.5	Industry Canada Statement .....	63
10	Japan (MIC) Regulatory .....	64
10.1	Antenna Information .....	64
11	CE Regulatory .....	65
11.1	Antenna Information .....	65
11.2	EU Declarations of Conformity .....	66
12	Ordering Information .....	67
13	Bluetooth SIG Qualification .....	67
13.1	Overview .....	67
13.2	Qualification Steps When Referencing a Laird End Product Design .....	67
13.3	Qualification Steps When Deviating from a Laird End Product Design .....	68
14	Additional Assistance .....	69

## 1 OVERVIEW AND KEY FEATURES

Every BL652 Series module is designed to enable OEMs to add single-mode Bluetooth Low Energy (BLE) v5.0 to small, portable, power-conscious devices. The BL652 modules are supported with Laird's *smartBASIC*, an event-driven programming language that enables OEMs to make their BLE product development quicker and simpler, significantly reducing time to market. *smartBASIC* enables customers to develop a complete embedded application inside the compact BL652 hardware, connecting to a wide array of external sensors via its I2C, SPI, UART, ADC or GPIO interfaces. The BL652 also provides flexibility in the OEM's application development choice with full support for using Nordic's SDK and firmware tools.

Based on the world-leading Nordic Semiconductor nRF52832 chipset, the BL652 modules provide ultra-low power consumption with outstanding wireless range via 4 dBm of transmit power. A broad range of BLE profiles including Temperature and Heart Rate are available, and *smartBASIC* provides the ideal mechanism to support any BLE profile development of your choice. This document should be read in conjunction with the *smartBASIC* user manual.

---

**Note:** BL652 hardware is functionally capable as the nRF52832 chipset used in the module design. Not all features are currently exposed within Laird's *smartBASIC* firmware implementation.

---

### 1.1 Features and Benefits

- Bluetooth v5.0 - Single mode
- NFC-A Listen mode compliant
- External or internal antennas
- *smartBASIC* programming language or Nordic SDK
- Compact footprint
- Programmable Tx power +4 dBm to -20 dBm
- Tx whisper mode (-40 dBm)
- Rx sensitivity: -96 dBm
- Ultra-low power consumption
- Tx: 5.3 mA peak (at 0 dBm, DCDC on) – See *Power Consumption* section Note 1
- Rx: 5.4 mA peak (DCDC on) – See *Power Consumption* section Note 1
- Standby Doze: 2.0 uA typical
- Deep Sleep: 0.4 uA – See *Power Consumption* section Note 4
- UART, GPIO, ADC, PWM, FREQ output, timers, I2C, and SPI interfaces
- Fast time-to-market
- FCC, CE, IC, and Japan certified; Full Bluetooth Declaration ID
- Other regulatory certifications on request (all certifications are in process)
- No external components required
- Industrial temperature range (-40 to + 85)

### 1.2 Application Areas

- Medical devices
- Wellness devices
- iOS "accessories"
- Fitness sensors
- Location awareness
- Home automation

---

**Note:** Figures on this page are gathered from the nRF52 datasheet provided by Nordic.

---

## 2 SPECIFICATION

### 2.1 Specification Summary

Table 1: BL652 Specifications

Categories	Feature	Implementation	
Wireless Specification	Bluetooth®	V5.0 – Single mode Concurrent master and slave Diffie-Hellman based pairing	
	Frequency	2.402 - 2.480 GHz	
	Maximum Transmit Power Setting	+4 dBm      Conducted BL652-SA +4 dBm      Conducted BL652-SC	
	Minimum Transmit Power Setting	-20 dBm (in 4 dB steps) with <i>smartBASIC</i> command -16 dBm, -12 dBm, - 8 dBm, - 4 dBm, 0 dBm	
	Tx Whisper Mode 1 Transmit Power	-40 dBm (min.) with <i>smartBASIC</i> command	
	Receive Sensitivity (0.1% BER)	-96 dBm typical	
	Link Budget	100 dB (@ 1 Mbps)	
	Range	Up to 100 meters in free space	
	Tx Whisper Modes	Range reduction feature with Tx Whisper modes via <i>smartBASIC</i> command	
	Range (Tx Whisper Mode 1)	<~100 cm	
	Raw Data Rates	1 Mbps (over-the-air)	
	NFC	NFC-A Listen mode compliant	Based on NFC forum specification <ul style="list-style-type: none"> <li>▪ 13.56 MHz</li> <li>▪ Data rate 106 kbps</li> <li>▪ NFC-A tag <ul style="list-style-type: none"> <li>– Can only be a target/tag; cannot be an initiator</li> </ul> </li> </ul> <b>Modes of Operation:</b> <ul style="list-style-type: none"> <li>▪ Disable</li> <li>▪ Sense</li> <li>▪ Activated</li> </ul> <b>Use Cases:</b> <ul style="list-style-type: none"> <li>▪ Touch-to-Pair with NFC</li> <li>▪ NFC enabled Out-of-Band Pairing</li> </ul>
		System Wake-On-Field function	Proximity Detection
Host Interface and Peripherals	Total	32 x Multifunction I/O lines Tx, Rx, CTS, RTS	
	UART	DCD, RI, DTR, DSR (See Note 1) Default 115200,n,8,1 From 1,200bps to 1Mbps	

Categories	Feature	Implementation
	GPIO	Up to 32, with configurable: I/O direction, O/P drive strength (standard 0.5 mA or high 3mA/5 mA), Pull-up /pull-down
	ADC	Eight 8/10/12-bit channels 0.6 V internal reference Configurable 4, 2, 1, 1/2, 1/3, 1/4, 1/5 1/6(default) pre-scaling Configurable acquisition time 3uS, 5uS, 10uS(default), 15uS, 20uS, 40uS. One-shot mode
	PWM output	PWM outputs on 12 GPIO output pins. PWM output duty cycle: 0%-100% PWM output frequency: Up to 500kHz (See <a href="#">Note 7</a> )
	FREQ output	FREQ outputs on 2 GPIO output pins. FREQ output frequency: 0 MHz-4MHz (50% duty cycle)
	I2C	One I2C interface (up to 400 kbps) (See <a href="#">Note 2</a> )
	SPI	One SPI Master interface (up to 4 Mbps) (See <a href="#">Note 3</a> )
<b>Optional</b> <i>External to the BL652 module</i>	External 32.768kHz crystal	For customer use, connect +/-20ppm accuracy crystal for more accurate protocol timing.
	External SPI serial flash	For customer use e.g. data-logging
<b>Profiles</b>	Services supported (See <a href="#">Note 4</a> )	Laird's <i>smartBASIC</i> firmware supports the following:: <ul style="list-style-type: none"> <li>▪ Central Mode</li> <li>▪ Peripheral Mode</li> <li>▪ Custom Series</li> </ul>
	Nordic SDK v3x0	Any exposed within the related Nordic softdevice (application development to be done by OEM)
<b>FW upgrade</b>	<i>smartBASIC</i> runtime engine FW upgrade (See <a href="#">Note 4</a> )	Via JTAG or UART
<b>Programmability</b>	<i>smartBASIC</i>	On-board programming language similar to BASIC.
	<i>smartBASIC</i> application download	Via UART Via Over-the-Air (if SIO_02 pin is pulled high externally)
	Nordic SDK	Via JTAG
<b>Control Protocols</b>	Any	User defined via <i>smartBASIC</i>

Categories	Feature	Implementation	
Operating Modes	Self-contained Run mode	Selected by nAutoRun pin status: LOW (0V). Then runs \$autorun\$ ( <i>smartBASIC</i> application script) if it exists.	
	Interactive/Development mode	HIGH (VCC). Then runs via at+run (and <i>file name</i> of <i>smartBASIC</i> application script).	
Supply Voltage	Supply (VCC)	1.8- 3.6 V – Internal DCDC converter or LDO (See <a href="#">Note 5</a> )	
Power Consumption (See <a href="#">Note 5</a> )	Active Modes Peak Current (for maximum Tx power +4 dBm) – Radio only	Advertising mode	7.5 mA peak Tx (with DCDC)
		Connecting mode	5.4 mA peak Tx (with DCDC)
	Active Modes Peak Current (for Tx Whisper mode2 power -40 dBm) – Radio only	Advertising mode	2.7 mA peak Tx (with DCDC)
		Connecting mode	5.4 mA peak Tx (with DCDC)
Active Modes Average Current	Depends on many factors, see <a href="#">Power Consumption</a> .		
Ultra Low Power Modes	Standby Doze	2.0 uA typical ( <a href="#">Note 6</a> )	
	Deep Sleep	400 nA ( <a href="#">Note 6</a> )	
Antenna Options	Internal	Ceramic chip monopole antenna – on-board <b>BL652-SA variant</b>	
	External	Dipole antenna (with IPEX connector) Dipole PCB antenna (with IPEX connector) Connection via IPEX MH4 – <b>BL652-SC variant</b>  See the Antenna Information sections for <a href="#">FCC</a> and <a href="#">IC</a> , <a href="#">MIC</a> , and <a href="#">CE</a> .	
Physical	Dimensions	14 mm x 10 mm x 2.1 (TBC) mm Pad Pitch: 0.75 mm Pad Type: Plated half-moon edge pads (easy to hand solder)	
	Weight	<1 gram	
Environmental	Operating	-40 °C to +85 °C (VCC 1.8V-3.6V)	
	Storage	-40 °C to +85 °C	
Miscellaneous	Lead Free	Lead-free and RoHS compliant	
	Warranty	1-Year Warranty	
Development Tools	Development Kit	Development kit (DVK-BL652-xx) and free software tools	
Approvals	Bluetooth®	Full Bluetooth SIG Declaration ID	
	FCC / IC / CE / MIC	All BL652 Series	

**Module Specification Notes:**

**Note 1** | DSR, DTR, RI, and DCD can be implemented in the *smartBASIC* application.



### Module Specification Notes:

- Note 2** With I2C interface selected, pull-up resistors on I2C SDA and I2C SCL **must** be connected externally as per I2C standard.
- Note 3** SPI interface (master) consists of SPI MOSI, SPI MISO, and SPI CLK. SPI CS is created by using any spare SIO pin within the *smartBASIC* application script allowing multi-dropping.
- Note 4** The BL652 module comes loaded with *smartBASIC* runtime engine firmware but does not come loaded with any *smartBASIC* application script (as that is dependent on customer-end application or use). Laird provides many sample *smartBASIC* application scripts covering the services listed. Additional BLE services are being added every quarter.
- Note 5** Use of the internal DCDC convertor or LDO is decided by the underlying BLE stack.
- Note 6** These figures are measured on the BL652-Sx-xx.
- Deep Sleep current for BL652-Sx-xx ~400nA (typical)
  - Standby Doze current for BL652-xx-A1 2.0 uA (typical)
- Note 7** PWM output signal has a frequency and duty cycle property. PWM output is generated using dedicated hardware in the chipset. There is a trade-off between PWM output frequency and resolution.
- For example:
- PWM output frequency of 500 kHz (2 uS) results in resolution of 1:2.
  - PWM output frequency of 100 kHz (10 uS) results in resolution of 1:10.
  - PWM output frequency of 10 kHz (100 uS) results in resolution of 1:100.
  - PWM output frequency of 1 kHz (1000 uS) results in resolution of 1:1000.

Refer to the *smartBASIC* user guide for details. It's available from the Laird BL652 product page.

### 3 HARDWARE SPECIFICATIONS

#### 3.1 Block Diagram and Pin-out

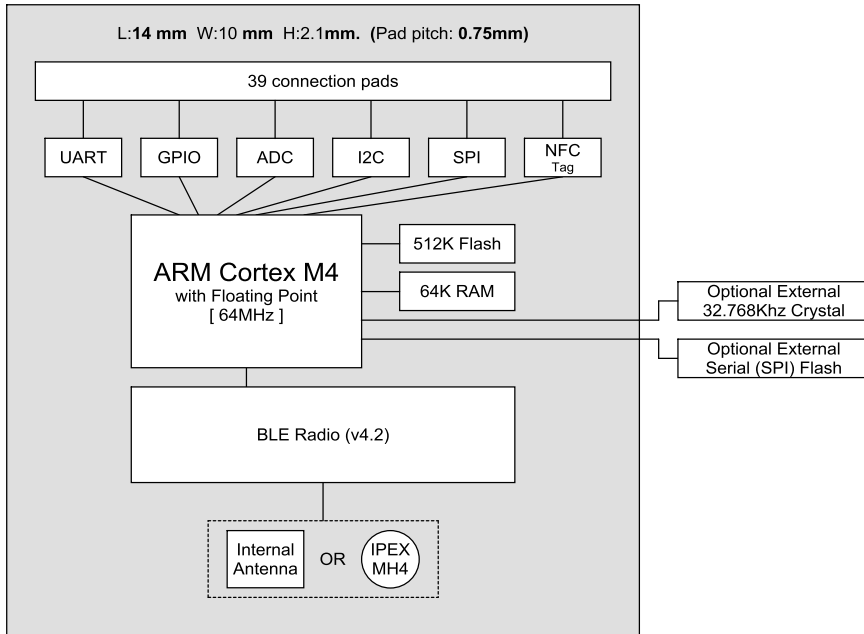

Figure 1: BL652 Block diagram

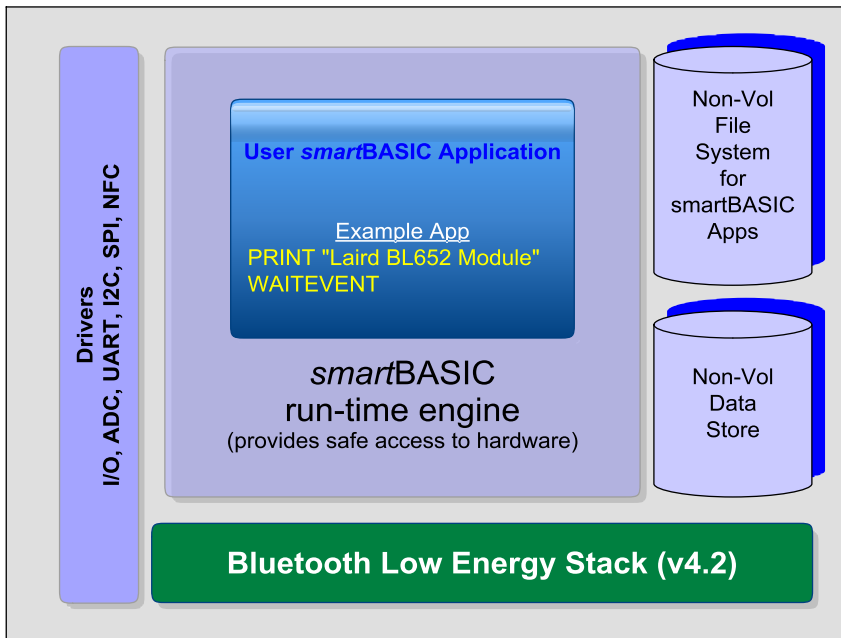

Figure 2: Functional HW and SW block diagram for BL652 series BLE smartBASIC module

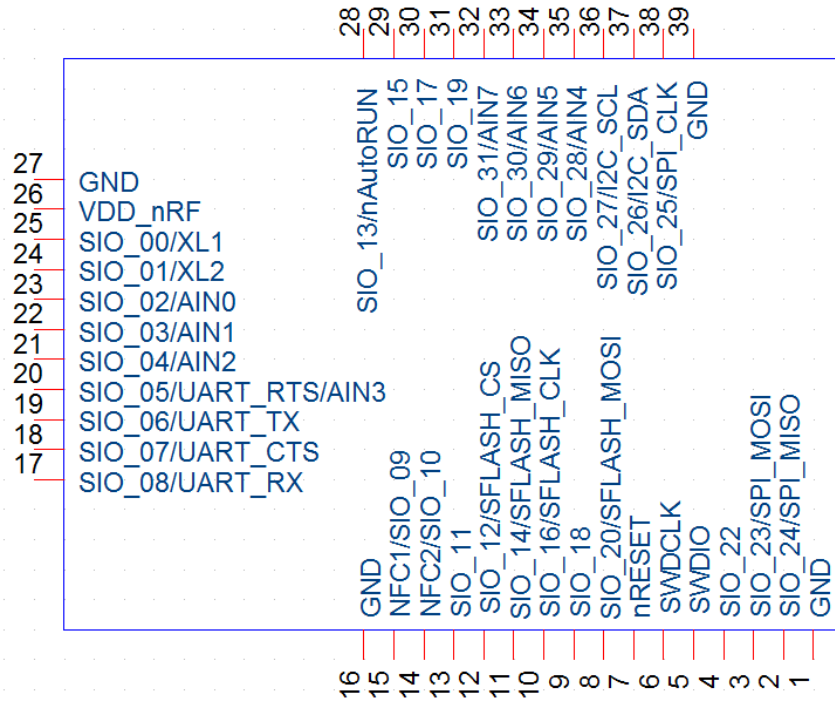

Figure 3: BL652-Sx module pin-out (top view)

### 3.2 Pin Definitions

Table 2: Pin definitions

Pin #	Pin Name	Default Function	Alternate Function	In/Out	Pull Up/Down	nRF52832 QFN Pin	nRF52832 QFN Name	Comment
1	GND	-	-	-	-	-	-	-
2	SIO_24/ SPI_MISO	SIO_24	SPI_MISO	IN	PULL-UP	29	PO.24	<b>Laird Devkit:</b> SPI EEPROM. SPI_Eeprom_MISO, Input.  SPIOpen() in smartBASIC selects SPI function; MOSI and CLK are outputs when in SPI master mode.
3	SIO_23/ SPI_MOSI	SIO_23	SPI_MOSI	IN	PULL-UP	28	PO.23	<b>Laird Devkit:</b> SPI EEPROM. SPI_Eeprom_MOSI, Output  SPIOpen() in smartBASIC selects SPI function, MOSI and CLK are outputs in SPI master.
4	SIO_22	SIO_22	-	IN	PULL-UP	27	PO.22	<b>Laird Devkit:</b> SPI EEPROM. SPI_Eeprom_CS, Input
5	SWDIO	SWDIO	-	-	PULL-UP	26	SWDIO	-

Pin #	Pin Name	Default Function	Alternate Function	In/Out	Pull Up/Down	nRF52832 QFN Pin	nRF52832 QFN Name	Comment
6	SWDCLK	SWDCLK	-	-	PULL-DOWN	25	SWDCLK	-
7	nRESET	nRESET	-	IN	PULL-UP	24	PO.21/ nRESET	System Reset (Active Low)
8	SIO_20/ SFLASH_MOSI	SIO_20	SFLASH_MOSI	IN	PULL-UP	23	PO.20	<p><b>Laird Devkit:</b> Optional External serial SPI flash for data logging purpose.</p> <p>High level API in <i>smartBASIC</i> can be used for fast access using open/close/read/write API functions.</p>
9	SIO_18	SIO_18	-	IN	PULL-UP	21	PO.18	-
10	SIO_16/ SFLASH_CLK	SIO_16	SFLASH_CLK	IN	PULL-UP	19	PO.16	<p><b>Laird Devkit:</b> Optional External serial SPI flash for data logging purpose.</p> <p>High level API in <i>smartBASIC</i> can be used for fast access using open/close/read/write API functions.</p>
11	SIO_14/ SFLASH_MISO	SIO_14	SFLASH_MISO	IN	PULL-UP	17	PO.14	
12	SIO_12/ SFLASH_CS	SIO_12	SFLASH_CS	IN	PULL-UP	15	PO.12	
13	SIO_11	SIO_11	-	IN	PULL-UP	14	PO.11	<b>Laird Devkit:</b> BUTTON1
14	NFC2/ SIO_10	NFC2	SIO_10	IN	-	12	PO.10/NFC2	-
15	NFC1/ SIO_09	NFC1	SIO_09	IN	-	11	PO.09/NFC1	-
16	GND	-	-	-	-	-	-	-
17	SIO_08/ UART_RX	SIO_08	UART_RX	IN	PULL-UP	10	PO.08	<p>UARTCLOSE() selects DIO functionality</p> <p>UARTOPEN() selects UART COMMS behaviour</p>
18	SIO_07/ UART_CTS	SIO_07	UART_CTS	IN	PULL-DOWN	9	PO.07	
19	SIO_06/ UART_TX	SIO_06	UART_TX	OUT	Set High in FW	8	PO.06	
20	SIO_05/ UART_RTS/ AIN3	SIO_05	UART_RTS/ AIN3	OUT	Set Low in FW	7	PO.05/AIN3	
21	SIO_04/ AIN2	SIO_04	AIN2	IN	PULL-UP	6	PO.04/AIN2	Internal pull-down
22	SIO_03/ AIN1	SIO_03	AIN1	IN	PULL-UP	5	PO.03/AIN1	<b>Laird Devkit:</b> Temp Sens Analog or Arduino Analog

Pin #	Pin Name	Default Function	Alternate Function	In/Out	Pull Up/Down	nRF52832 QFN Pin	nRF52832 QFN Name	Comment
23	SIO_02/ AIN0	SIO_02	AIN0	IN	PULL-DOWN	4	PO.02/AIN0	Internal pull-down
24	SIO_01/ XL2	SIO_01	XL2	IN	PULL-UP	3	PO.01/XL2	<b>Laird Devkit:</b> Optional 32.768kHz crystal pad XL2
25	SIO_00/ XL1	SIO_00	XL1	IN	PULL-UP	2	PO.00/XL1	<b>Laird Devkit:</b> Optional 32.768kHz crystal pad XL1
26	VDD_nRF	-	-	-	-	-	-	1.7V to 3.6V
27	GND	-	-	-	-	-	-	-
28	SIO_13/ nAutoRUN	nAutoRUN	SIO_13	IN	PULL-DOWN	16	PO.13	<b>Laird Devkit:</b> FTDI USB_DTR via jumper on J12pin1-2.
29	SIO_15	SIO_15	-	IN	PULL-UP	18	PO.15	<b>Laird Devkit:</b> BUTTON2
30	SIO_17	SIO_17	-	IN	PULL-UP	20	PO.17	<b>Laird Devkit:</b> LED1
31	SIO_19	SIO_19	-	IN	PULL-UP	22	PO.19	<b>Laird Devkit:</b> LED2
32	SIO_31/ AIN7	SIO_31	AIN7	IN	PULL-UP	43	PO.31/AIN7	-
33	SIO_30/ AIN6	SIO_30	AIN6	IN	PULL-UP	42	PO.30/AIN6	-
34	SIO_29/ AIN5	SIO_29	AIN5	IN	PULL-UP	41	PO.29/AIN5	-
35	SIO_28/ AIN4	SIO_28	AIN4	IN	PULL-UP	40	PO.28/AIN4	-
36	SIO_27/ I2C_SCL	SIO_27	I2C_SCL	IN	PULL-UP	39	PO.27	<b>Laird Devkit:</b> I2C RTC chip. I2C clock line.
37	SIO_26/ I2C_SDA	SIO_26	I2C_SDA	IN	PULL-UP	38	PO.26	<b>Laird Devkit:</b> I2C RTC chip. I2C data line.
38	SIO_25/ SPI_CLK	SIO_25	SPI_CLK	IN	PULL-UP	37	PO.25	<b>Laird Devkit:</b> SPI EEPROM. SPI_Eeprom_CLK, Output  SPIOPEN() in <i>smartBASIC</i> selects SPI function, MOSI and CLK are outputs when in SPI master mode.
39	GND	-	-	-	-	-	-	-

**Pin Definition Notes:**

**Note 1** | SIO = Signal Input or Output. Secondary function is selectable in *smartBASIC* application.

**Pin Definition Notes:**

**Note 2** DIO = Digital Input or Output.  
I/O voltage level tracks VCC.

**Note 3** AIN = Analog Input

**Note 4** DIO or AIN functionality is selected using the GpioSetFunc() function in *smartBASIC*.

**Note 5** AIN configuration selected using GpioSetFunc() function.

**Note 6** I2C, UART, SPI controlled by xxxOPEN() functions in *smartBASIC*.

**Note 7** SIO\_5 to SIO\_8 are DIO by default when \$autorun\$ app runs on power-up.

**Note 8** JTAG (two-wire SWD interface), pin 5 (SWDIO) and pin 6 (SWDCLK).

Laird recommends you use JTAG (2-wire interface) to handle future BL652 module firmware upgrades. You MUST wire out the JTAG (2-wire interface) on your host design (see Figure 8, where four lines should be wired out, namely SWDIO, SWDCLK, GND and VCC). Firmware upgrades can still be performed over the BL652 UART interface, but this is slower (60 seconds using UART vs. 10 seconds when using JTAG) than using the BL652 JTAG (2-wire interface).

Upgrading *smartBASIC* runtime engine firmware or loading the *smartBASIC* applications is done using the UART interface.

**Note 9** Pull the nRESET pin (pin 7) low for minimum 100 milliseconds to reset the BL652.

**Note 10** SPI CS is created by using any spare SIO pin within their *smartBASIC* application script allowing multi-dropping.

**Note 11** The SIO\_02 pin must be pulled high externally to enable an OTA (over-the-air) *smartBASIC* application download. Refer to the latest firmware release documentation for details.

**Note 12** Ensure that SIO\_02 (pin 23) and AutoRUN (pin 28) are **not both high** (externally), in that state, the UART is bridged to Virtual Serial Port service; the BL652 module does not respond to AT commands and cannot load *smartBASIC* application scripts.

**Note 13** The *smartBASIC* runtime engine has DIO (Default Function) INPUT pins, which are set PULL-UP by default. This avoids floating inputs (which can cause current consumption to drive with time in low power modes (such as Standby Doze). You can disable the PULL-UP through your *smartBASIC* application.

All of the SIO pins (with a default function of DIO) are inputs (apart from SIO\_05 and SIO\_06, which are outputs):

- SIO\_06 (alternative function UART\_TX) is an output, set High (in the firmware).
- SIO\_05 (alternative function UART\_RTS) is an output, set Low (in the firmware).

**Pin Definition Notes:**

- SIO\_08 (alternative function UART\_RX) is an input, set with internal pull-up (in the firmware).
- SIO\_07 (alternative function UART\_CTS) is an input, set with internal pull-down (in the firmware).
- SIO\_02 is an input set with internal pull-down (in the firmware). It is used for OTA downloading of *smartBASIC* applications. Refer to the latest firmware release documentation for details.

**Note 14** Not required for BL652 module normal operation. If you fit an external serial (SPI) flash for data logging purposes, then that external serial (SPI) flash must connect to BL652 module pins SIO\_12 (SFLASH\_CS), SIO\_14 (SFLASH\_MISO), SIO\_16 (SFLASH\_CLK), and SIO\_20 (SFLASH\_MOSI); in that case, a high level API in *smartBASIC* can be used for fast access using open/close/read/write API functions.

By default, these are GPIO pins. Only when in their FlashOpen() *smartBASIC* app are these lines dedicated to SPI and for talking to the off-board flash.

If you decide to use an external serial (SPI) flash with BL652-SX-xx, then **ONLY** the manufacturer part numbers below **MUST** be used:

- 4 Mbit Macronix MX25R4035F  
<http://www.macronix.com/Lists/DataSheet/Attachments/3288/MX25R4035F,%20Wide%20Range,%204Mb,%20v1.2.pdf>
- 8 Mbit Macronix MX25R8035F  
<http://www.macronix.com/Lists/DataSheet/Attachments/3532/MX25R8035F,%20Wide%20Range,%208Mb,%20v1.2.pdf>

*smartBASIC* does not provide access to any external serial (SPI) flash other than these part numbers.

**Note 15** Not required for BL652 module normal operation. The on-chip 32.768kHz RC oscillator provides the standard accuracy of  $\pm 250$  ppm, with calibration required every 8seconds (default) to stay within  $\pm 250$  ppm.

BL652 also allows as an option to connect an external higher accuracy ( $\pm 20$  ppm) 32.768 kHz crystal to the BL652-SX-xx pins SIO\_01/XL2 (pin 24) and SIO\_00/XL1 (pin 25). This provides higher accuracy protocol timing and helps with radio power consumption in the system standby doze/deep sleep modes by reducing the time that the Rx window must be open.

The BL652 module is delivered with the integrated *smartBASIC* runtime engine firmware loaded (but no onboard *smartBASIC* application script). Therefore it boots into AT command mode by default.

At reset, all SIO lines are configured as the defaults shown above.

SIO lines can be configured through the *smartBASIC* application script to be either inputs or outputs with pull-ups or pull-downs. When an alternative SIO function is selected (such as I2C or SPI), the firmware does not allow the setup of internal pull-up/pull-down. Therefore, when I2C interface is selected, pull-up resistors on I2C SDA and I2C SCL **must** be connected externally as per I2C standard.

UART\_RX, UART\_TX, and UART\_CTS are 3.3 V level logic (if VCC is 3.3 V; such as SIO pin I/O levels track VCC). For example, when Rx and Tx are idle, they sit at 3.3 V (if VCC is 3.3 V). Conversely, handshaking pins CTS and RTS at 0V are treated as assertions.

Pin 28 (nAutoRUN) is an input, with active low logic. In the development kit (DVK-BL652-xx) it is connected so that the state is driven by the host's DTR output line. The nAutoRUN pin must be externally held high or low to select between the following two BL652 operating modes:

- Self-contained Run mode (nAutoRUN pin held at 0V –this is the default (internal pull-down enabled))
- Interactive/Development mode (nAutoRUN pin held at VCC)

The *smartBASIC* runtime engine firmware checks for the status of nAutoRUN during power-up or reset. If it is low and if there is a *smartBASIC* application script named **\$autorun\$**, then the *smartBASIC* runtime engine firmware executes the application script automatically; hence the name *Self-contained Run Mode*.

### 3.3 Electrical Specifications

#### 3.3.1 Absolute Maximum Ratings

Absolute maximum ratings for supply voltage and voltages on digital and analogue pins of the module are listed below; exceeding these values causes permanent damage.

**Table 3: Maximum current ratings**

Parameter	Min	Max	Unit
Voltage at VDD_nRF pin	-0.3	+3.9 (Note 1)	V
Voltage at GND pin		0	V
Voltage at SIO pin (at VDD_nRF ≤ 3.6V)	-0.3	VDD_nRF +0.3	V
Voltage at SIO pin (at VDD_nRF ≥ 3.6V)	-0.3	3.9	V
NFC antenna pin current (NFC1/2)	-	80	mA
Radio RF input level	-	10	dBm
<b>Environmental</b>			
Storage temperature	-40	+85	°C
MSL (Moisture Sensitivity Level)	-	3	-
ESD (as per EN301-489)			
Conductive		4	KV
Air Coupling		8	KV
Flash Memory (Endurance) (Note 2)	-	10000	Write/erase cycles
Flash Memory (Retention)	-	10 years at 40°C	-

#### Maximum Ratings Notes:

**Note 1** | The absolute maximum rating for VCC pin (max) is 3.9V for the BL652-Sx-xx.

**Note 2** | Wear levelling is used in file system.



### 3.3.2 Recommended Operating Parameters

Table 4: Power supply operating parameters

Parameter	Min	Typ	Max	Unit
VDD_nRF (independent of DCDC) <sup>1</sup>	1.8	3.3	3.6	V
VCC Maximum ripple or noise <sup>2</sup>	-	-	10	mV
VCC rise time (0 to 1.7V) <sup>3</sup>	-	-	60	mS
Operating Temperature Range	-40	-	+85	°C

#### Recommended Operating Parameters Notes:

- Note 1** 4.7 uF internal to module on VCC. In *smart*BASIC runtime engine firmware, use of the internal DCDC convertor or LDO is decided by the underlying BLE stack.
- Note 2** This is the maximum VCC ripple or noise (at any frequency) that does not disturb the radio.
- Note 3** The on-board power-on reset circuitry may not function properly for rise times outside the noted interval.

Table 5: Signal levels for interface, SIO

Parameter	Min	Typ	Max	Unit
V <sub>IH</sub> Input high voltage	0.7 VDD_nRF		VDD_nRF	V
V <sub>IL</sub> Input low voltage	VSS		0.3 x VDD_nRF	V
V <sub>OH</sub> Output high voltage (std. drive, 0.5mA) (Note 1)	VDD_nRF -0.4		VDD_nRF	V
(high-drive, 3mA) (Note 1)	VDD_nRF -0.4		VDD_nRF	V
(high-drive, 5mA) (Note 2)	VDD_nRF -0.4		VDD_nRF	V
V <sub>OL</sub> Output low voltage (std. drive, 0.5mA) (Note 1)	VSS		VSS+0.4	V
(high-drive, 3mA) (Note 1)	VSS		VSS+0.4	V
(high-drive, 5mA) (Note 2)	VSS		VSS+0.4	V
V <sub>OL</sub> Current at VSS+0.4V, Output set low (std. drive, 0.5mA) (Note 1)	1	2	4	mA
(high-drive, 3mA) (Note 1)	3	-	-	mA
(high-drive, 5mA) (Note 2)	6	10	15	mA
V <sub>OL</sub> Current at VDD_nRF -0.4, Output set low (std. drive, 0.5mA) (Note 1)	1	2	4	mA
(high-drive, 3mA) (Note 1)	3	-	-	mA
(high-drive, 5mA) (Note 2)	6	9	14	mA
Pull up resistance	11	13	16	kΩ
Pull down resistance	11	13	16	kΩ
Pad capacitance		3		pF

Parameter	Min	Typ	Max	Unit
Pad capacitance at NFC pads		4		pF

**Signal Levels Notes:**

- Note 1** For VDD\_nRF≥1.7V. The *smartBASIC* firmware supports high drive (3 mA, as well as standard drive).
- Note 2** For VDD\_nRF≥2.7V. The *smartBASIC* firmware supports high drive (5 mA (since VDD\_nRF≥2.7V), as well as standard drive).

**Table 6: SIO pin alternative function AIN (ADC) specification**

Parameter	Min	Typ	Max	Unit
ADC Internal reference voltage	-1.5%	0.6 V	+1.5%	%
ADC pin input internal selectable scaling		4, 2, 1, 1/2, 1/3, 1/4, 1/5 1/6		scaling
ADC input pin (AIN) voltage maximum without damaging ADC w.r.t <sup>1</sup>				
VCC Prescaling 0V-VDD_nRF	4, 2, 1, ½, 1/3, ¼, 1/5, 1/6	VDD+0.3		V
Configurable via smartBASIC Resolution	8bit mode	10bit mode	12bit mode	bits
Configurable via smartBASIC <sup>2</sup>				
Acquisition Time, source resistance ≤10kΩ		3		µS
Acquisition Time, source resistance ≤40kΩ		5		µS
Acquisition Time, source resistance ≤100kΩ		10		µS
Acquisition Time, source resistance ≤200kΩ		15		µS
Acquisition Time, source resistance ≤400kΩ		20		µS
Acquisition Time, source resistance ≤800kΩ		40		µS
Conversion Time <sup>3</sup>		<2		µS
ADC input impedance (during operation) <sup>3</sup>				
Input Resistance		>1		MOhm
Sample and hold capacitance at maximum gain		2.5		pF

**Recommended Operating Parameters Notes:**

- Note 1** Stay within internal 0.6 V reference voltage with given pre-scaling on AIN pin and do not violate ADC maximum input voltage (for damage) for a given VCC, e.g. If VCC is 3.6V, you can only expose AIN pin to VDD+0.3 V. Default pre-scaling is 1/6 which configurable via smartBASIC.
- Note 2** smartBASIC runtime engine firmware allows configurable resolution (8-bit, 10-bit or 12-bit mode) and acquisition time. The sampling frequency is limited by the sum of sampling time and acquisition time. The maximum sampling time is 2µs. For acquisition time of 3µs the total conversion time is therefore 5µs, which makes maximum sampling frequency of 1/5µs = 200kHz. Similarly, if acquisition

**Recommended Operating Parameters Notes:**

time of 40us chosen, then the conversion time is 42us and the maximum sampling frequency is  $1/42\mu s = 23.8\text{kHz}$

**Note 3** ADC input impedance is estimated mean impedance of the ADC (AIN) pins.

### 3.3.3 nAutoRUN Pin and Operating Modes

Operating modes (refer to the *smartBASIC* guide for details):

- Self-contained mode
- Interactive/Development mode

**Table 7: nAutoRUN pin**

Signal Name	Pin #	I/O	Comments
nAutoRUN /(SIO_13)	28	I	Input with active low logic. Internal pull down (default). Operating mode selected by nAutoRun pin status: <ul style="list-style-type: none"> <li>▪ If Low (0V), runs \$autorun\$ if it exists</li> <li>▪ If High (VCC), runs via at+run (and file name of application)</li> </ul>

Pin 28 (nAutoRUN) is an input, with active low logic. In the development board (DVK-BL652-xx) it is connected so that the state is driven by the host's DTR output line. nAutoRUN pin needs to be externally held high or low to select between the two BL652 operating modes:

- Self-contained Run mode (nAutoRUN pin held at 0V).
- Interactive/Development mode (nAutoRUN pin held at VCC).

*smartBASIC* runtime engine firmware checks for the status of nAutoRUN during power-up or reset. If it is low AND if there is a *smartBASIC* application named \$autorun\$, the *smartBASIC* runtime engine executes the application automatically; hence the name *self-contained run mode*.

### 3.3.4 OTA (Over-the-Air) smartBASIC Application Download

Refer to latest firmware release documentation (firmware release notes and *smartBASIC* user guide) for details.

**Table 8: OTA mode**

Signal Name	Pin #	I/O	Comments
SIO_02	23	I	Internal pull down (default). OTA mode selected by externally pulling-up SIO_02 pin: <b>High (VCC)</b> , then OTA <i>smartBASIC</i> application download is possible.

The OTA *smartBASIC* application download feature can be useful for production because it allows the module to be soldered into an end product without pre-configuration; the application can then be downloaded over-the-air once the product has been pre-tested.

**Note:** It is the *smartBASIC* application that is downloaded over-the-air and NOT the firmware. Since this is principally designed for use in production with multiple programming stations in a locality, the transmit power is limited (to lower Tx power). See the **smartBASIC user guide** for more details.

## 4 POWER CONSUMPTION

Data taken at VCC\_nRF of 3.0 V with internal (to chipset) LDO ON or with internal (to chipset) DCDC ON (see Note 1) and 25°C.

### 4.1 Power Consumption

Table 9: Power consumption

Parameter	Min	Typ	Max	Unit
<b>Active mode ‘peak’ current (Note 1) (Advertising or Connection)</b>		With DCDC [with LDO]		
Tx only run peak current @ Txpwr = +4 dBm		7.5 [16.6]		mA
Tx only run peak current @ Txpwr = 0 dBm		5.3 [11.6]		mA
Tx only run peak current @ Txpwr = -4 dBm		4.2 [9.3]		mA
Tx only run peak current @ Txpwr = -8 dBm		3.8 [8.4]		mA
Tx only run peak current @ Txpwr = -12 dBm		3.5 [7.7]		mA
Tx only run peak current @ Txpwr = -16 dBm		3.3 [7.3]		mA
Tx only run peak current @ Txpwr = -20 dBm		3.2 [7.0]		mA
<b>Tx Whisper mode 1 (Note 2)</b>		2.7 [5.9]		mA
Tx only run peak current @ Txpwr = -40 dBm				
<b>Active Mode</b>				
Rx only ‘peak’ current (Note 2)		5.4 [11.7]		mA
<b>Ultra Low Power Mode 1 (Note 2)</b>		2.0		uA
Standby Doze, 64k RAM retention				
<b>Ultra Low Power Mode 2 (Note 3)</b>		400		nA
Deep Sleep (no RAM retention)				
<b>Active Mode Average current (Note 4)</b>				
<b>Advertising Average Current draw</b>				
Max, with advertising interval (min) 20 mS		~511		uA
Min, with advertising interval (max) 10240 mS		~3.2		uA
<b>Connection Average Current draw</b>				
Max, with connection interval (min) 7.5 mS		~513		uA
Min, with connection interval (max) 4000 mS		~2.9		uA

#### Power Consumption Notes:

- Note 1** This is for Peak Radio Current only, but there is additional current due to the MCU, refer to [Table 12](#) and [Table 15](#) for the peak and "Average Advert/connection (burst) current" consumption profile (with DCDC on) during advertising and connection versus TX power. In *smartBASIC* runtime engine firmware, use of the internal DCDC convertor or LDO is decided by the underlying BLE stack.
- Note 2** BL652-Sx-xx: Standby Doze is 2.0 uA typical. Standby Doze is entered automatically (when a waitevent

statement is encountered within a smartBASIC application script). In Standby Doze, all peripherals that are enabled stay on and may re-awaken the chip. Depending on active peripherals, current consumption ranges from  $\sim 2.0 \mu\text{A}$  to  $270 \mu\text{A}$  (when UART is ON). See individual peripherals current consumption data in the Peripheral Block Current Consumption section. smartBASIC runtime engine firmware has added new functionality to detect GPIO change with no current consumption cost, it is possible to close the UART and get to the  $2.0\mu\text{A}$  current consumption regime and still be able to detect for incoming data and be woken up so that the UART can be re-opened at expense of losing that first character.

The BL652 Standby Doze current consists of the below nRF52 blocks:

- nRF52 System ON IDLE current (no RAM retention) ( $1.2 \mu\text{A}$ ) – This is the base current of the CPU
- LFRC ( $0.35 \mu\text{A}$ ) and RTC ( $0.1\mu\text{A}$ ) running as well as 64k RAM retention ( $0.32 \mu\text{A}$ ) – This adds to the total of  $2 \mu\text{A}$  typical.

**Note 3** In Deep Sleep, everything is disabled and the only wake-up sources (including NFC to wakeup) are reset and changes on SIO or NFC pins on which sense is enabled. The current consumption seen is  $\sim 400 \text{ nA}$  typical in BL652-Sx-xx.

- smartBASIC runtime engine firmware requires a hardware reset to come out of deep sleep.
- smartBASIC runtime engine firmware also allows coming out from Deep Sleep to Standby Doze through GPIO signal through the reset vector. Deep Sleep mode is entered with a command in smartBASIC application script.

**Note 4** Data taken with a transmit power of 4 dBm and all peripherals off (UART OFF after radio event), slave latency of 0 (in a connection). Average current consumption depends on a number of factors (including Tx power, VCC, accuracy of 32MHz and 32.768 kHz). With these factors fixed, the largest variable is the advertising or connection interval set.

Advertising Interval range:

- 20 milliseconds to 10240 milliseconds in multiples of 0.625 milliseconds for the following Advert type: ADV\_IND and ADV\_DIRECT\_IND
- 100 milliseconds to 10240 milliseconds in multiples of 0.625 milliseconds for the following Advert types: ADV\_SCAN\_IND and ADV\_NONCONN\_IND

For advertising timeout, if the advert type is ADV\_DIRECT\_IND, then the timeout is limited to 1.28 seconds (1280 milliseconds).

For an advertising event:

- The minimum average current consumption is when the advertising interval is large 10240 mS (although this may cause long discover times (for the advertising event) by scanners
- The maximum average current consumption is when the advertising interval is small 20 mS

Other factors that are also related to average current consumption include the advertising payload bytes in each advertising packet and whether it's continuously advertising or periodically advertising.

Connection Interval range:

- 7.5 milliseconds to 4000 milliseconds in multiples of 1.25 milliseconds.

For a connection event:

- The minimum average current consumption is when the connection interval is large 4000 milliseconds
- The maximum average current consumption is with the shortest connection interval of 7.5 ms; no slave latency.

Other factors that are also related to average current consumption include:

- Whether transmitting six packets per connection interval with each packet containing 20 bytes (which is the maximum for each packet)
- An inaccurate 32.768 kHz master clock accuracy would increase the average current consumption.

## 4.2 Measured Current Waveforms during Advertising and Connection

The following figures illustrate current waveforms observed as the BL652 module performs advertising and connection functionality.

TX power – 4 dBm

29 byte payload

Advert duration ~4.377 ms

Advertising interval – 20 ms

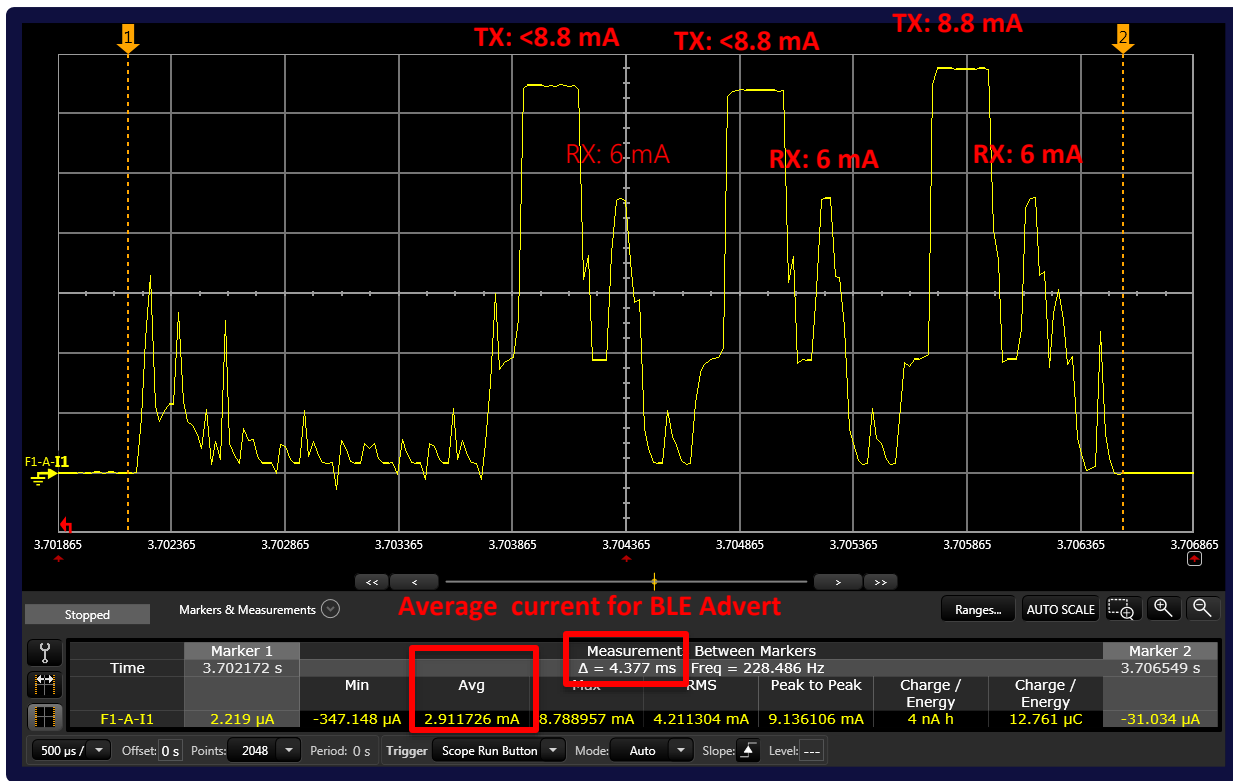

Figure 4: Typical peak current consumption profile (with DCDC ON) during advertising in slave mode @ TX PWR +4 dBm. UART is OFF

TX power – 4 dBm  
Interval – 7.5 ms

29 byte payload  
Advertising interval – 20 ms

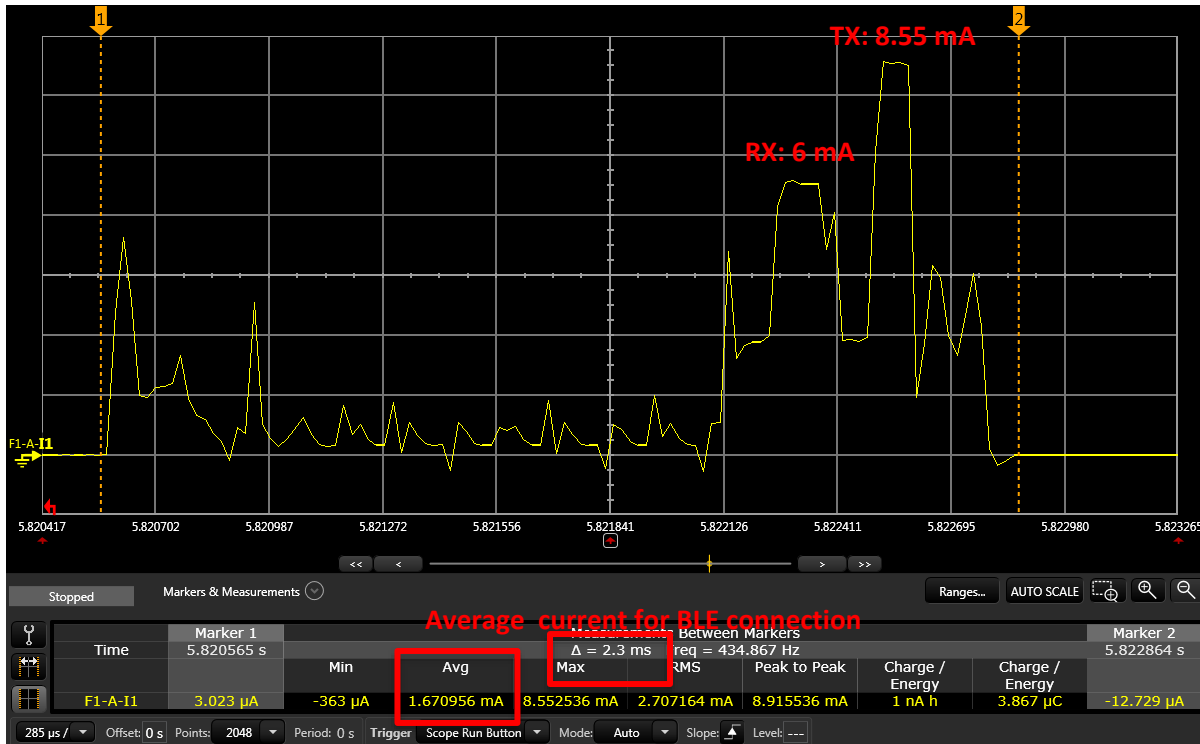

Figure 5: Typical peak current consumption profile (with DCDC ON) during data connection event in slave mode @ TX PWR +4dBm UART is OFF

**Note:** In the above pictures, UART is OFF. Y-axis current (1.3 mA per square).

To make things easier the average current during the whole BLE event is shown in the plot above, and then the BLE event total charge consumption is found by multiplying the average current over the BLE event with the length of the event. This charge can then be used to extrapolate the average current for **different advertising intervals**, by dividing by the interval. Then the StandbyDoze (IDLE) current must be added to give the total average current. In this example we can calculate the average current to be:

The total charge of the BLE event:

$$\text{BLE\_charge} = \text{BLE\_avg} * \text{BLE\_length}$$

The average current consumed by the BLE event for a specific interval:

$$\text{BLE\_avg} = \text{BLE\_charge} / (\text{BLE\_interval} + \text{perturbation})$$

The perturbation is given as a random number between 0 and 10 milliseconds added to the interval to prevent advertisers to periodically transmit at the exact same time. This averages to 5 milliseconds.

Adding the IDLE current (StandbyDoze mode) to the inactive part of the interval:

$$\text{TOT\_avg} = \text{BLE\_avg} + \text{IDLE} * (\text{BLE\_interval} - \text{BLE\_length}) / \text{BLE\_interval}$$

Performing the calculation with the numbers 25mS advertising interval and TX power for 4dBm for example:

$$\text{BLE\_charge} = 4.377 \text{ ms} * 2.91 \text{ mA} = 12.74 \text{ uC}$$

$$\text{BLE\_avg} = 12.74 \text{ uC} / (20 \text{ ms} + 5 \text{ ms}) = 509.78 \text{ uA}$$

$$\text{TOT\_avg} = 509.78 \text{ uA} + 2 \text{ uA} * (25 \text{ ms} - 4.377 \text{ ms}) / 25 \text{ ms} = 511.43 \text{ uA}$$

Table 10 and Table 11 display the measured "Average Advert (Burst) current" (for a given TX power) which can be used to calculate the Total average current for any advertising interval.

Table 12 and Table 13 display the measured "Average Connection (Burst) current" (for a given TX power) which can be used to calculate the Total average current for any connection interval.

The following table (Table 10) shows the measured total average current consumption profile (with DCDC on) during advertising in slave mode versus TX power for a minimum advertising interval of 25 milliseconds. Note that UART is off.

**Table 10: Measured total average current consumption profile – for a minimum advertising interval of 25 ms**

TX Power (dBm)	Average Advert (Burst) Current (uA)	Average Advert (Burst) Duration (mS)	BLE Advert Charge (uC)	BLE Advert Interval 20 mS plus 5 mS Perturbation	BLE Advert Average (uA)	Max Standby Doze Current (uA)	BLE Advert Interval 20 mS plus 5 mS Perturbation	Total Average Current (uA)
4	2911.726	4.377	12744.625	25	509.785	2	25	511.435
0	2431.095	4.377	10640.903	25	425.636	2	25	427.286
-4	2163.884	4.377	9471.320	25	378.853	2	25	380.503
-8	2151.602	4.377	9417.562	25	376.702	2	25	378.352
-12	2086.596	4.377	9133.031	25	365.321	2	25	366.971
-16	2052.041	4.377	8981.783	25	359.271	2	25	360.921
-20	2029.615	4.377	8883.625	25	355.345	2	25	356.995
-40	1960.112	4.377	8579.410	25	343.177	2	25	344.826

The following table (Table 11) shows the measured total average current consumption profile (with DCDC on) during advertising in slave mode versus TX power for a maximum advertising interval of 10240 milliseconds. Note that UART is off.



**Table 11: Measured total average current consumption profile – for a minimum advertising interval of 10240 ms**

TX Power (dBm)	Average Advert (Burst) Current (uA)	Average Advert (Burst) Duration (mS)	BLE Advert Charge (uC)	BLE Advert Interval 10240 mS plus 5 mS Perturbation	BLE Advert Average (uA)	Max Standby Doze Current (uA)	BLE Advert Interval 10240 mS plus 5 mS Perturbation	Total Average Current (uA)
4	2911.726	4.377	12744.625	10245	1.244	2	10245	3.243
0	2431.095	4.377	10640.903	10245	1.039	2	10245	3.038
-4	2163.884	4.377	9471.320	10245	0.924	2	10245	2.924
-8	2151.602	4.377	9417.562	10245	0.919	2	10245	2.918
-12	2086.596	4.377	9133.031	10245	0.891	2	10245	2.891
-16	2052.041	4.377	8981.783	10245	0.877	2	10245	2.876
-20	2029.615	4.377	8883.625	10245	0.867	2	10245	2.866
-40	1960.112	4.377	8579.410	10245	0.837	2	10245	2.837

Table 12 displays measured peak and "Average Advert (burst) current" consumption profile (with DCDC on) during advertising in slave mode versus TX power. Between Marker 1 and 2 is the average BLE advert current.

**Table 12: Measured average advert (burst) current consumption profiles (with DCDC on) during advertising in slave mode vs TX power**

TX power: 4 dBm  
Advert

29 byte payload  
20 ms interval

Average BLE advert current burst  
(excluding advertising interval): 2.911 mA

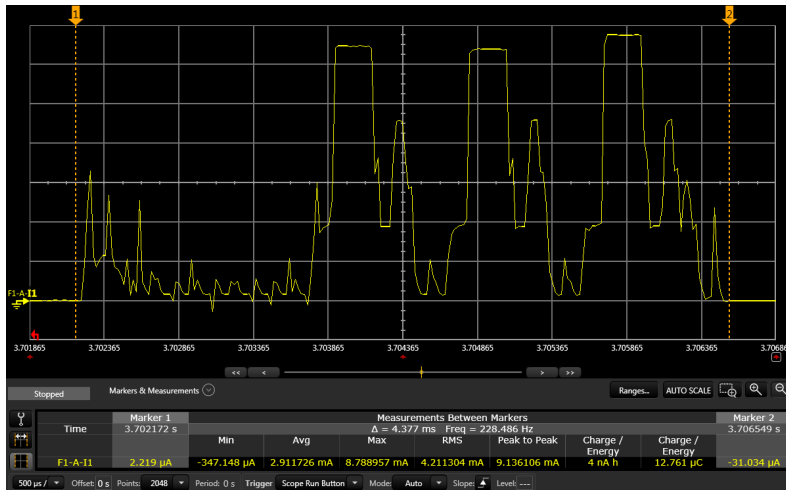

Aside:  
Peak TX current: 8.8 mA  
Peak RX current: 6 mA

**TX power: 0 dBm**  
**Advert**

**29 byte payload**  
**20 ms interval**

**Average BLE advert current burst**  
**(excluding advertising interval): 2.431 mA**

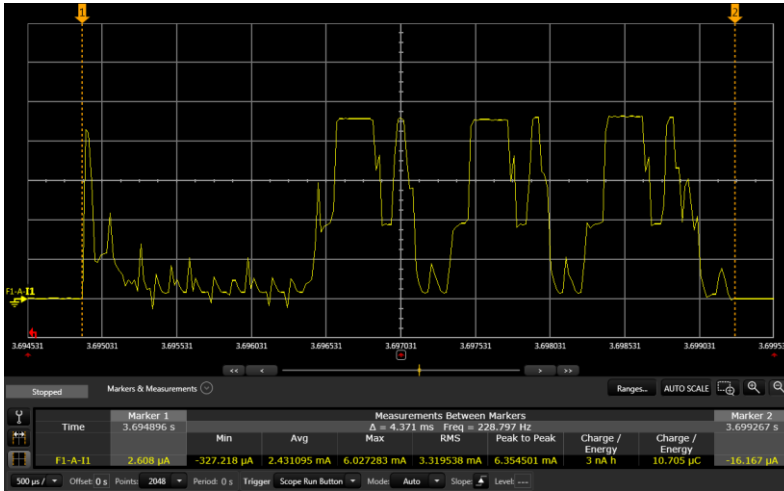

**Aside:**  
**Peak TX current: 6 mA**  
**Peak RX current: 6 mA**

**TX power: -4 dBm**  
**Advert**

**29 byte payload**  
**20 ms interval**

**Average BLE advert current burst**  
**(excluding advertising Interval): 2.163 mA**

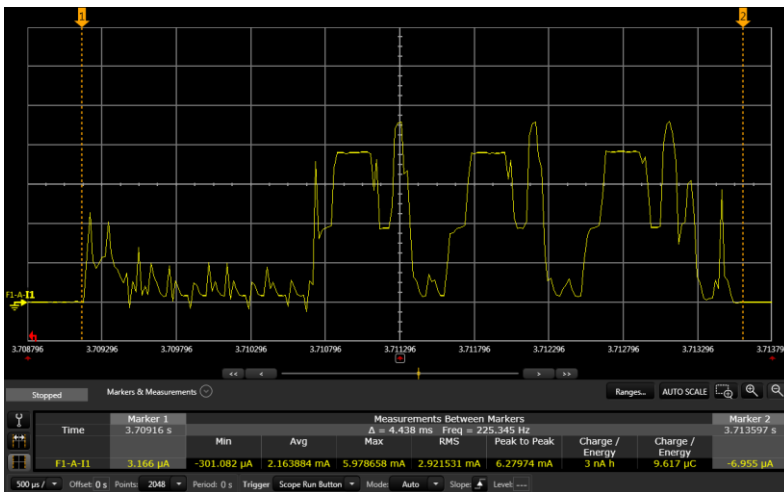

**Aside:**  
**Peak TX current: 4.98 mA**  
**Peak RX current: 5.99 mA**

**TX power: -8 dBm**  
**Advert**

**29 byte payload**  
**20 ms interval**

**Average BLE advert current burst**  
**(excluding advertising Interval): 2.151 mA**

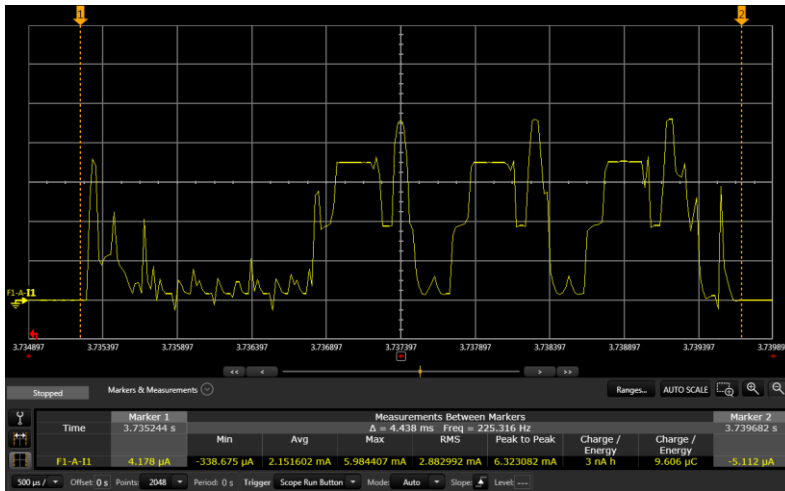

**Aside:**  
**Peak TX current: 4.59 mA**  
**Peak RX current: 5.98 mA**

**TX power: -12 dBm**  
**Advert**

**29 byte payload**  
**20 ms interval**

**Average BLE advert current burst**  
**(excluding advertising Interval): 2.086 mA**

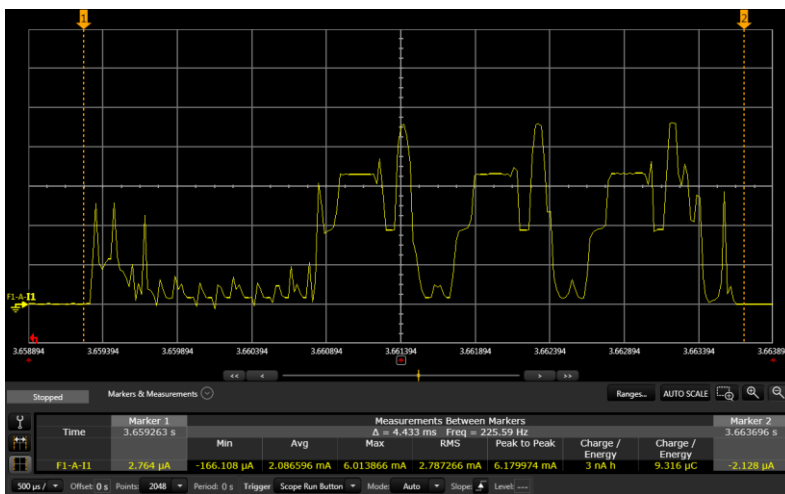

**Aside:**  
**Peak TX current: 4.34 mA**  
**Peak RX current: 5.99 mA**

**TX power: -16 dBm**  
**Advert**

**29 byte payload**  
**20 ms interval**

**Average BLE advert current burst**  
**(excluding advertising Interval): 2.052 mA**

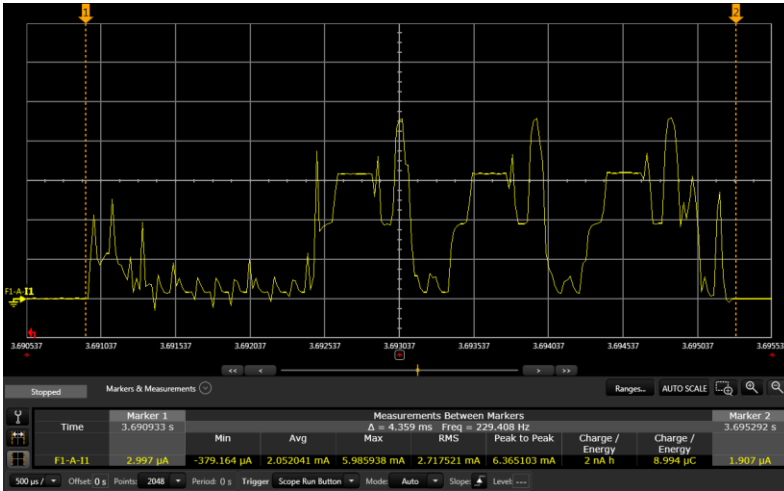

**Aside:**  
**Peak TX current: 4.16 mA**  
**Peak RX current: 5.99 mA**

**TX power: -20 dBm**  
**Advert**

**29 byte payload**  
**20 ms interval**

**Average BLE advert current burst**  
**(excluding advertising Interval): 2.029 mA**

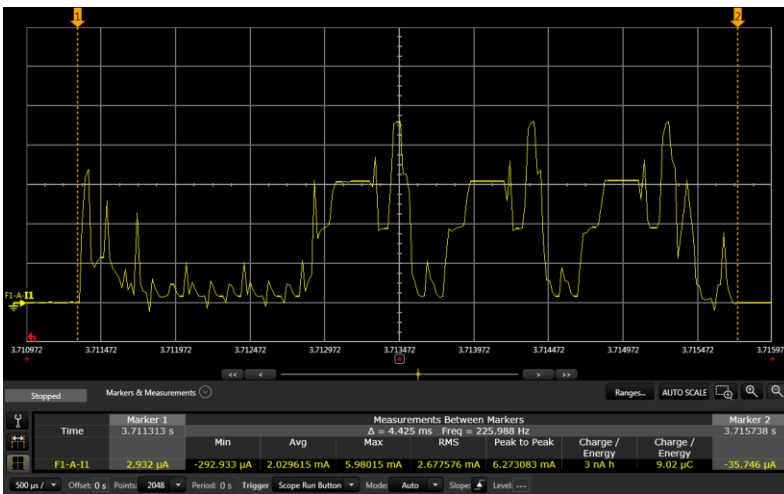

**Aside:**  
**Peak TX current: 4.03 mA**  
**Peak RX current: 5.99 mA**

TX power: -40 dBm  
Advert

29 byte payload  
20 ms interval

Average BLE advert current burst  
(excluding advertising Interval): 1.960 mA

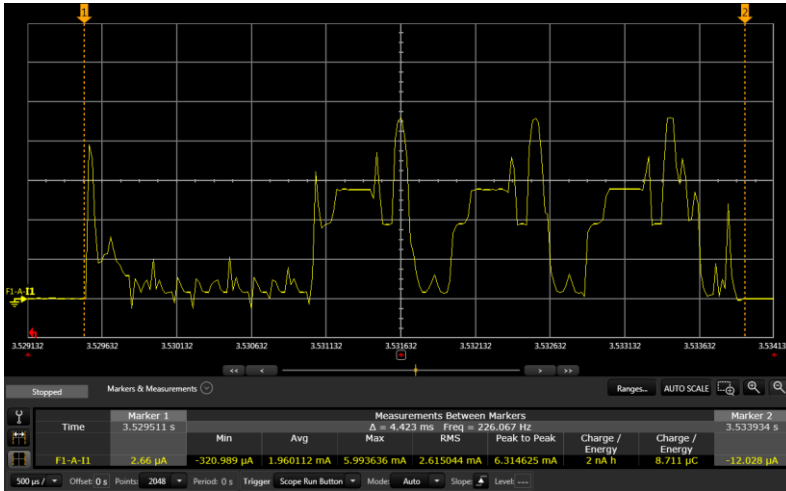

Refer to table for worked out total BLE advert average current for given advertising interval.

Aside:  
Peak TX current: 3.6 mA  
Peak RX current: 6.01 mA

Table 13 and Table 14 has the measured "Average Connection (Burst) current" (for a given TX power) which can be used to calculate the Total average current for any connection interval.

**Table 13: Measured Total average current consumption profile (with DCDC ON) during connection in slave mode versus TX POWER for minimum Connection interval of 7.5 mS. UART is OFF**

TX power (dBm)	Average Connection (Burst) Current (uA)	Average Connection (Burst) Duration (mS)	BLE Connection Charge (uC)	BLE Connection Interval (mS)	BLE Connection Average (uA)	Max Standby Doze Current (uA)	BLE Connection Interval 7.5 ms	Total Average Current (uA)
4	1670.956	2.3	3843.199	7.5	512.427	2	7.5	513.813
0	1560.069	2.3	3588.159	7.5	478.421	2	7.5	479.808
-4	1513.156	2.3	3480.259	7.5	464.035	2	7.5	465.421
-8	1492.133	2.3	3431.906	7.5	457.587	2	7.5	458.974
-12	1488.407	2.3	3423.336	7.5	456.445	2	7.5	457.831
-16	1469.042	2.3	3378.797	7.5	450.506	2	7.5	451.893
-20	1454.618	2.3	3345.621	7.5	446.083	2	7.5	447.470
-40	1428.215	2.3	3284.895	7.5	437.986	2	7.5	439.373

**Table 14: Measured Total average current consumption profile (with DCDC ON) during connection in slave mode versus TX POWER for minimum Connection interval of 4000ms. UART is OFF**

TX power (dBm)	Average Connection (Burst) Current (uA)	Average Connection (Burst) Duration (mS)	BLE Connection Charge (uC)	BLE Connection Interval (mS)	BLE Connection Average (uA)	Max Standby Doze Current (uA)	BLE Connection Interval 7.5 ms	Total Average Current (uA)
4	1670.956	2.3	3843.199	4000	0.961	2	4000	2.960
0	1560.069	2.3	3588.159	4000	0.897	2	4000	2.896
-4	1513.156	2.3	3480.259	4000	0.870	2	4000	2.869
-8	1492.133	2.3	3431.906	4000	0.858	2	4000	2.857
-12	1488.407	2.3	3423.336	4000	0.856	2	4000	2.855
-16	1469.042	2.3	3378.797	4000	0.845	2	4000	2.844
-20	1454.618	2.3	3345.621	4000	0.836	2	4000	2.835
-40	1428.215	2.3	3284.895	4000	0.821	2	4000	2.820

Table 15 displays the typical peak and "Average Connection (Burst) current" consumption profile (with DCDC on) during a connection event in slave mode versus TX power. Between Marker 1 and 2 is the average BLE connection current.

**Table 15: Average connection current consumption profiles during a connection event in slave mode**

TX power: 4 dBm  
Connection

29 byte payload  
7.5 ms interval

Average BLE connection burst current  
(excluding connection Interval): 1.67 mA

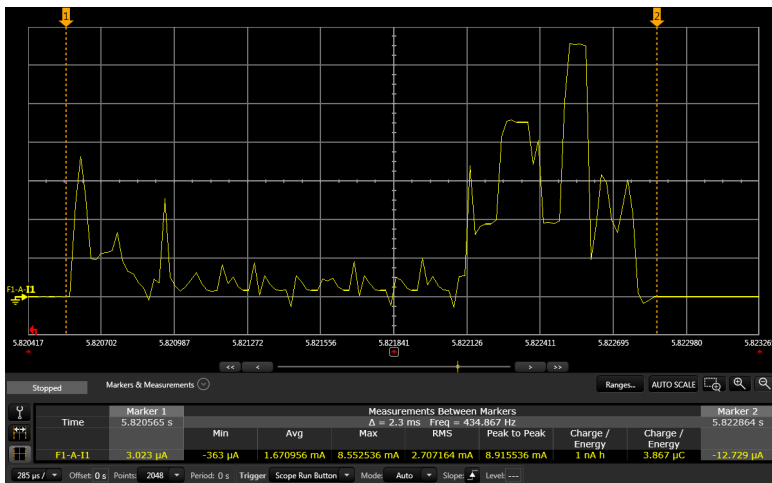

Aside:  
Peak RX current: 5.95mA  
Peak TX current: 8.55mA

TX power: 0 dBm  
 Connection

29 byte payload (2.3 ms)  
 7.5 ms interval

Average BLE connection burst current  
 (excluding connection Interval): 1.56 mA

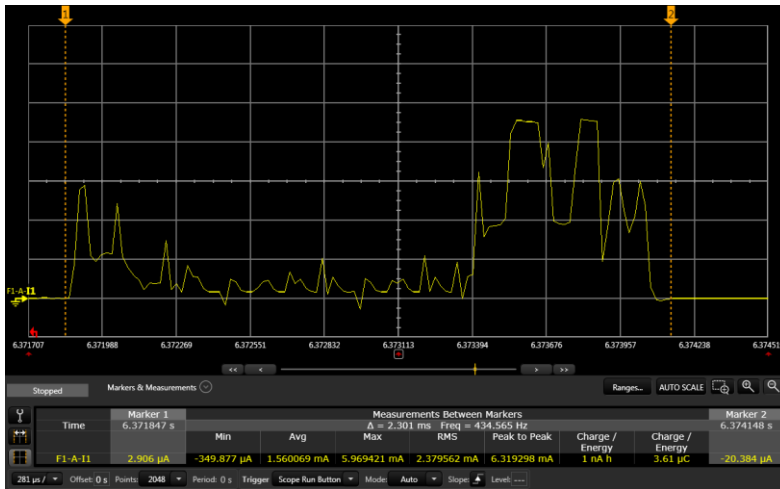

Aside:  
 Peak RX current: 5.92 mA  
 Peak TX current: 5.96 mA

TX power: -4 dBm  
 Connection

29 byte payload (2.3 ms)  
 7.5 ms interval

Average BLE connection burst current  
 (excluding connection Interval): 1.513 mA

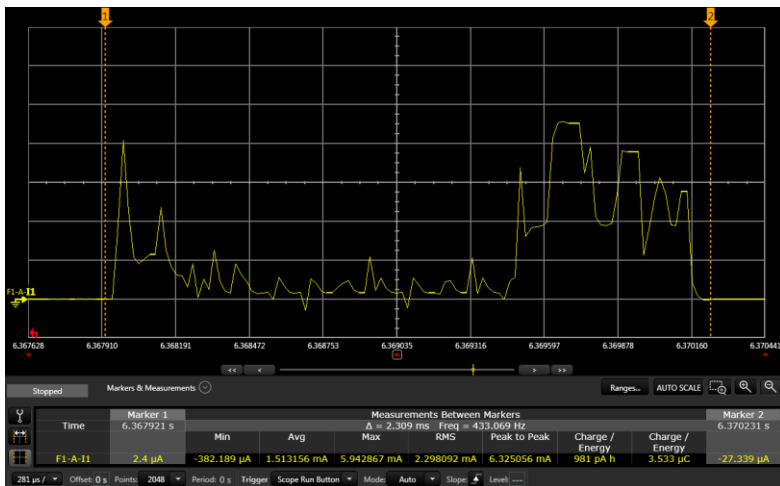

Aside:  
 Peak RX current: 5.94 mA  
 Peak TX current: 4.95 mA

**TX power: -8 dBm**  
**Connection**

**29 byte payload (2.3 ms)**  
**7.5 ms interval**

**Average BLE connection burst current**  
**(excluding connection Interval): 1.492**  
**mA**

**Aside:**  
**Peak RX current: 5.92 mA**  
**Peak TX current: 4.58 mA**

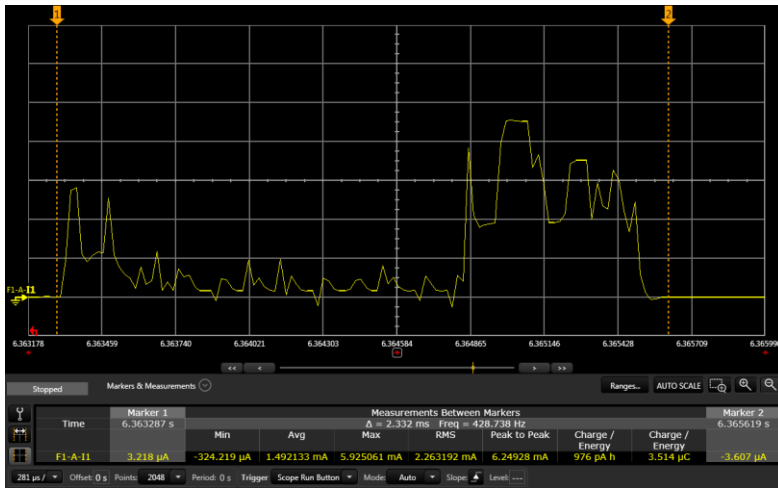

**TX power: -12 dBm**  
**Connection**

**29 byte payload (2.3 ms)**  
**7.5 ms interval**

**Average BLE connection burst current**  
**(excluding connection Interval): 1.488**  
**mA**

**Aside:**  
**Peak RX current: 5.93 mA**  
**Peak TX current: 4.30 mA**

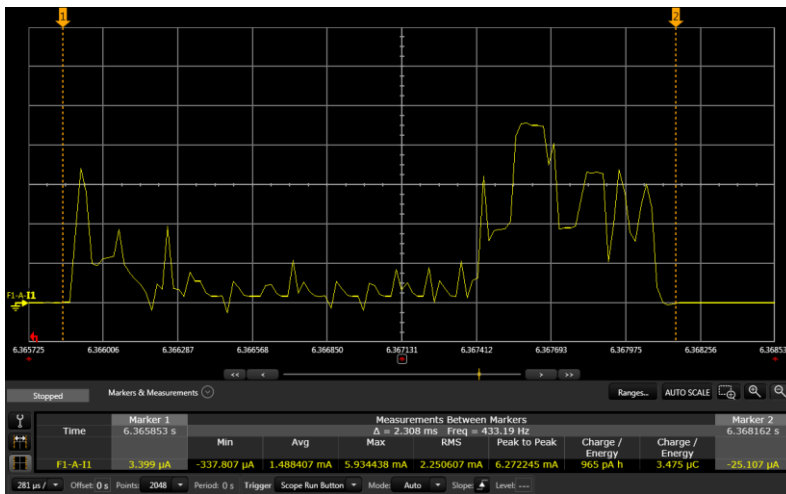



**TX power: -16 dBm**  
**Connection**

**29 byte payload (2.3 ms)**  
**7.5 ms interval**

**Average BLE connection burst current**  
**(excluding connection Interval):**  
**1.469 mA**

**Aside:**  
**Peak RX current: 5.94 mA**  
**Peak TX current: 4.17 mA**

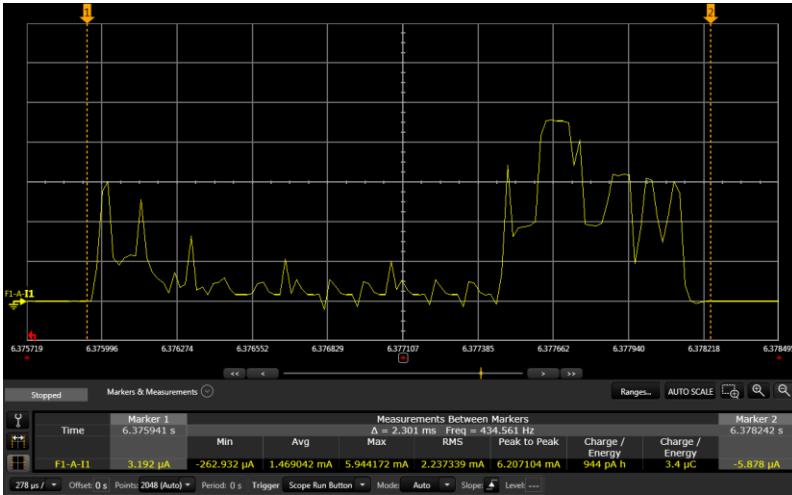

**TX power: -20 dBm**  
**Connection**

**29 byte payload (2.3 ms)**  
**7.5 ms interval**

**Average BLE connection burst current**  
**(excluding connection Interval):**  
**1.454 mA**

**Aside:**  
**Peak RX current: 5.95 mA**  
**Peak TX current: 4.03 mA**

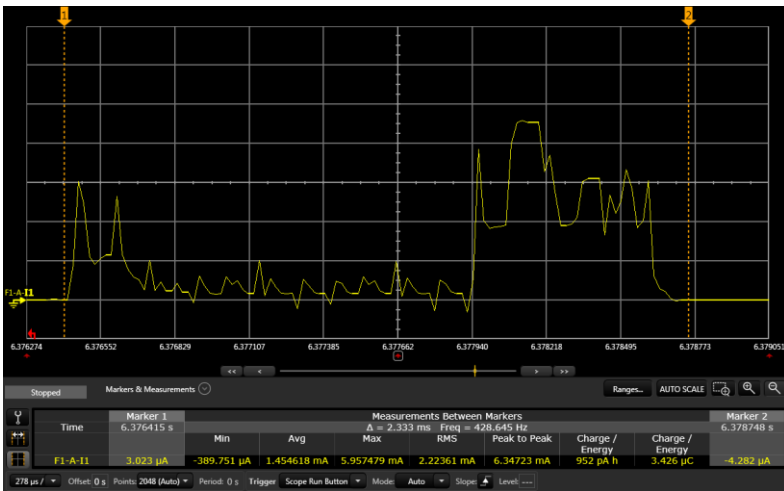

TX power: -40 dBm  
Connection

29 byte payload (2.3 ms)  
7.5 ms interval

Average BLE connection burst current  
(excluding connection Interval):  
1.428 mA

Aside:  
Peak RX current: 5.94 mA  
Peak TX current: 3.62 mA

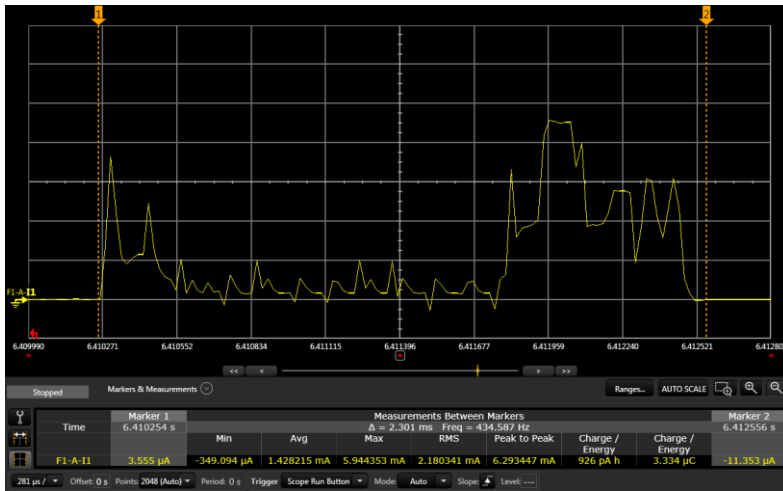

### 4.3 Peripheral Block Current Consumption

The values below are calculated for a typical operating voltage of 3V.

**Table 16: UART power consumption**

Parameter	Min	Typ	Max	Unit
UART Run current @ 115200 bps	-	55	-	$\mu$ A
UART Run current @ 1200 bps	-	55	-	$\mu$ A
Idle current for UART (no activity)	-	1	-	$\mu$ A
UART Baud rate	1.2	-	1000	kbps

**Table 17: power consumption**

Parameter	Min	Typ	Max	Unit
SPI Master Run current @ 2 Mbps	-	50	-	$\mu$ A
SPI Master Run current @ 8 Mbps	-	50	-	$\mu$ A
SPI bit rate	0.125	-	8	Mbps

**Table 18: I2C power consumption**

Parameter	Min	Typ	Max	Unit
I2C Run current @ 100 kbps	-	50	-	$\mu$ A
I2C Run current @ 400 kbps	-	50	-	$\mu$ A
I2C Bit rate	100	-	400	kbps

**Table 19: ADC power consumption**

Parameter	Min	Typ	Max	Unit
ADC current during conversion	-	700	-	uA

The above current consumption is for the given peripheral only and to operate that peripheral requires some other internal blocks which consume base current. This base current is consumed when the UART, SPI, I2C, or ADC is opened (operated).

For asynchronous interface like the UART (asynchronous as the other end can communicate at any time), the UART on the BL652 must be kept open (by a command in *smartBASIC* application script), resulting in the base current consumption penalty.

For a synchronous interface like the I2C or SPI (since BL652 side is the master), the interface can be closed and opened (by a command in *smartBASIC* application script) only when needed, resulting in current saving (no base current consumption penalty). There's a similar argument for ADC (open ADC when needed).

## 5 FUNCTIONAL DESCRIPTION

The BL652 BLE (Bluetooth Low Energy) module is a self-contained product and requires only power and a user's *smartBASIC* application to implement full BLE functionality. The integrated, high performance antenna combined with the RF and base-band circuitry provides the BLE wireless link, and any of the SIO lines provide the OEM's chosen interface connection to the sensors. The user's *smartBASIC* application binds the sensors to the BLE wireless functionality.

The variety of hardware interfaces and the *smartBASIC* programming language allow the BL652 module to serve a wide range of wireless applications while reducing overall time to market and the learning curve for developing BLE products.

To provide the widest scope for integration, a variety of physical host interfaces/sensors are provided. The major BL652 series module functional blocks described below.

### 5.1 Power Management (includes Brown-out and Power on Reset)

Power management features:

- System Standby Doze and Deep Sleep modes
- Open/Close Peripherals (UART, SPI, I2C, SIO's, ADC, NFC). Peripherals consume current when open; each peripheral can be individually closed to save power consumption (with a command in a *smartBASIC* application script)
- Use of the internal DCDC convertor or LDO is decided by the underlying BLE stack
- *smartBASIC* command allows the VCC voltage to be read (through the internal ADC)
- Pin wake-up system from deep sleep (including from NFC pins)

Power supply features:

- Supervisor hardware to manage power during reset, brownout, or power fail.
- 1.8V to 3.6V supply range using internal DCDC convertor or LDO decided by the underlying BLE stack.

## 5.2 Clocks and Timers

### 5.2.1 Clocks

The integrated high accuracy 32 MHz ( $\pm 10$  ppm) crystal oscillator helps with radio operation and reducing power consumption in the active modes.

The integrated on-chip 32.768 kHz RC oscillator ( $\pm 250$  ppm) provides protocol timing and helps with radio power consumption in the system StandByDoze and Deep Sleep modes by reducing the time that the RX window needs to be open.

To keep the on-chip 32.768 kHz RC oscillator within  $\pm 250$  ppm (which is needed to run the BLE stack) accuracy, RC oscillator needs to be calibrated (which takes 16-17 mS) regularly. The default calibration interval is eight seconds which is enough to keep within  $\pm 250$  ppm. The calibration interval ranges from 0.25 seconds to 31.75 seconds (in multiples of 0.25 seconds) and configurable via *smartBASIC* command `at+cfg210`.

### 5.2.2 Timers

In keeping with the event driven paradigm of *smartBASIC*, the timer subsystem enables *smartBASIC* applications to be written which allow future events to be generated based on timeouts.

- **Regular Timer** – There are eight built-in timers (regular timers) derived from a single RTC clock which are controlled solely by *smartBASIC* functions. The resolution of the regular timer is 976 microseconds.
- **Tick Timer** – A 31-bit free running counter that increments every (1) millisecond. The resolution of this counter is 488 microseconds. Use the functions `GetTickCount()` and `GetTickSince()` to access this counter.

Refer to the *smartBASIC User Guide* available from the Laird BL652 product page.

## 5.3 Memory for *smartBASIC* Application Code

You have up to 32 kbytes of data memory available for *smartBASIC* application script.

## 5.4 Radio Frequency (RF)

- 2402–2480 MHz Bluetooth Low Energy radio (one Mbps over the air data rate).
- Tx output power of +4 dBm programmable (via *smartBASIC* command) to -20 dBm in steps of 4 dB.
- Tx Whisper mode1 -40 dBm (via *smartBASIC* command).
- Receiver (with integrated channel filters) to achieve maximum sensitivity -96 dBm @ 1 Mbps BLE.
- RF conducted interface available in the following two ways:
  - BL652-SA: RF connected to on-board antenna on BL652-SA
  - BL652-SC: RF connected to on-board IPEX MH4 RF connector on BL652-SC
- Antenna options:
  - Integrated monopole chip antenna on BL652-SA
  - External dipole antenna connected with to IPEX MH4 RF connector on BL652-SC

## 5.5 NFC

NFC-A Listen mode compliant:

- Based on NFC forum specification
  - 13.56 MHz

- Data rate 106 kbps
- NFC-A tag (can only be a target/tag; cannot be an initiator)
- Modes of Operation:
  - Disable
  - Sense
  - Activated

### 5.5.1 Use Cases

- Touch-to Pair with NFC
- Launch a smartphone app (on Android)
- NFC enabled Out-of-Band Pairing
- System Wake-On-Field function
  - Proximity Detection

## 5.6 UART Interface

The Universal Asynchronous Receiver/Transmitter offers fast, full-duplex, asynchronous serial communication with built-in flow control support (UART\_CTS, UART\_RTS) in HW up to one Mbps baud. Parity checking and generation for the ninth data bit are supported.

UART\_TX, UART\_RX, UART\_RTS, and UART\_CTS form a conventional asynchronous serial data port with handshaking. The interface is designed to operate correctly when connected to other UART devices such as the 16550A. The signaling levels are nominal 0 V and 3.3 V (tracks VCC) and are inverted with respect to the signaling on an RS232 cable.

Two-way hardware flow control is implemented by UART\_RTS and UART\_CTS. UART\_RTS is an output and UART\_CTS is an input. Both are active low.

These signals operate according to normal industry convention. UART\_RX, UART\_TX, UART\_CTS, UART\_RTS are all 3.3 V level logic (tracks VCC). For example, when RX and TX are idle they sit at 3.3 V. Conversely for handshaking pins CTS, RTS at 0 V is treated as an assertion.

The module communicates with the customer application using the following signals:

- Port/TxD of the application sends data to the module's UART\_RX signal line
- Port/RxD of the application receives data from the module's UART\_TX signal line

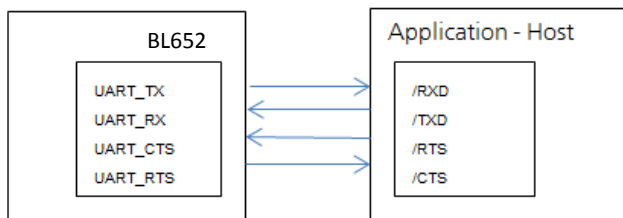

Figure 6: UART signals

---

**Note:** The BL652 serial module output is at 3.3V CMOS logic levels (tracks VCC). Level conversion must be added to interface with an RS-232 level compliant interface.

---

Some serial implementations link CTS and RTS to remove the need for handshaking. We do not recommend linking CTS and RTS other than for testing and prototyping. If these pins are linked and the host sends data at the point that the BL652 deasserts its RTS signal, then there is significant risk that internal receive buffers will overflow, which could lead to an internal processor crash. This will drop the connection and may require a power cycle to reset the module. We recommend that the correct CTS/RTS handshaking protocol be adhered to for proper operation.

**Table 20: UART interface**

Signal Name	Pin No	I/O	Comments
SIO_06 / UART_Tx	19	O	SIO_06 (alternative function UART_Tx) is an output, set high (in firmware).
SIO_08 / UART_Rx	17	I	SIO_08 (alternative function UART_Rx) is an input, set with internal pull-up (in firmware).
SIO_05 / UART_RTS	20	O	SIO_05 (alternative function UART_RTS) is an output, set low (in firmware).
SIO_07 / UART_CTS	18	I	SIO_07 (alternative function UART_CTS) is an input, set with internal pull-down (in firmware).

The UART interface is also used to load customer developed *smartBASIC* application script.

## 5.7 SPI Bus

The SPI interface is an alternate function on SIO pins, configurable by *smartBASIC*.

The module is a master device that uses terminals SPI\_MOSI, SPI\_MISO, and SPI\_CLK. SPI\_CS is implemented using any spare SIO digital output pins to allow for multi-dropping.

The SPI interface enables full duplex synchronous communication between devices. It supports a 3-wire (SPI\_MOSI, SPI\_MISO, SPI\_SCK,) bidirectional bus with fast data transfers to and from multiple slaves. Individual chip select signals are necessary for each of the slave devices attached to a bus, but control of these is left to the application through use of SIO signals. I/O data is double-buffered.

The SPI peripheral supports SPI mode 0, 1, 2, and 3.

**Table 21: SPI interfaces**

Signal Name	Pin No	I/O	Comments
SIO_23/SPI_MOSI	3	O	This interface is an alternate function configurable by <i>smartBASIC</i> . Default in the FW pin 3 and 38 are SIO inputs. SPIOPEN() in <i>smartBASIC</i> selects SPI function and changes pin 3 and 38 to outputs (when SPI master mode).
SIO_24/SPI_MISO	2	I	
SIO_25/SPI_CLK	38	O	
Any_SIO/SPI_CS	4	I	SPI_CS is implemented using any spare SIO digital output pins to allow for multi-dropping. On Laird devboard SIO_22 (pin4) used as SPI_CS.

## 5.8 I2C Interface

The I2C interface is an alternate function on SIO pins, configurable by *smartBASIC* command.

The two-wire interface can interface a bi-directional wired-OR bus with two lines (SCL, SDA) and has master /slave topology. The interface is capable of clock stretching. Data rates of 100 kbps and 400 kbps are supported.

An I2C interface allows multiple masters and slaves to communicate over a shared wired-OR type bus consisting of two lines which normally sit at VCC. The BL652 module can only be configured as an I2C master with additional constraint that it be the only master on the bus. The SCL is the clock line which is always sourced by the master and SDA is a bi-directional data line which can be driven by any device on the bus.

**IMPORTANT:** It is essential to remember that pull-up resistors on both SCL and SDA lines are not provided in the module and **MUST** be provided external to the module.

**Table 22: I2C interface**

Signal Name	Pin No	I/O	Comments
SIO_26/I2C_SDA	37	I/O	This interface is an alternate function on each pin, configurable by <i>smartBASIC</i> . I2COPEN() in <i>smartBASIC</i> selects I2C function.
SIO_27/I2C_SCL	36	I/O	

## 5.9 General Purpose I/O, ADC, PWM and FREQ

### 5.9.1 GPIO

The 19 SIO pins are configurable by *smartBASIC*. They can be accessed individually. Each has the following user configured features:

- Input/output direction
- Output drive strength (standard drive 0.5 mA or high drive 5mA)
- Internal pull-up and pull-down resistors (13 K typical) or no pull-up/down
- Wake-up from high or low level triggers on all pins including NFC pins

### 5.9.2 ADC

The ADC is an alternate function on SIO pins, configurable by *smartBASIC*.

The BL652 provides access to 8-channel 8/10/12-bit successive approximation ADC in one-shot mode. This enables sampling up to 8 external signals through a front-end MUX. The ADC has configurable input and reference pre-scaling and sample resolution (8, 10, and 12 bit).

#### 5.9.2.1 Analog Interface (ADC)

**Table 23: Analog interface**

Signal Name	Pin No	I/O	Comments
SIO_05/UART_RTS/AIN3 – Analog Input	20	I	This interface is an alternate function on each pin, configurable by <i>smartBASIC</i> . AIN configuration selected using <i>GpioSetFunc()</i> function.
SIO_04/AIN2 – Analog Input	21	I	
SIO_03/AIN1 – Analog Input	22	I	Configurable 8, 10, 12 bit resolution.
SIO_02/AIN0 – Analog Input	23	I	
SIO_31/AIN7 – Analog Input	32	I	Configurable voltage scaling 4, 2, 1/1, 1/3, 1/3, 1/4, 1/5, 1/6(default).
SIO_30/AIN6 – Analog Input	33	I	
SIO_29/AIN5 – Analog Input	34	I	Configurable acquisition time 3uS, 5uS, 10uS(default), 15uS, 20uS, 40uS.
SIO_28/AIN4 – Analog Input	35	I	

### 5.9.3 PWM Signal Output on up to 12 SIO Pins

The PWM output is an alternate function on SIO pins, configurable by *smartBASIC*.

The ability to output a PWM (Pulse Width Modulated) signal on ALL GPIO (SIO) output pins can be selected using `GpioSetFunc()` function.

The **PWM output** signal has a frequency and duty cycle property. Frequency is adjustable (up to 1MHz ) and the duty cycle can be set over a range from 0% to 100% (both configurable by *smartBASIC* command).

### 5.9.4 FREQ Signal Output on up to 2 SIO Pins

The FREQ output is an alternate function on SIO pins, configurable by *smartBASIC*.

The ability to output a FREQ output signal on 2 GPIO (SIO) output pins can be selected using `GpioSetFunc()` function.

---

**Note:** The frequency driving each of the two SIO pins is the same but the duty cycle can be independently set for each pin.

---

**FREQ output** signal frequency can be set over a range of 0Hz to 4 MHz (with 50% mark-space ratio).

## 5.10 nRESET pin

Table 24: nRESET pin

Signal Name	Pin No	I/O	Comments
nRESET	7	I	BL652 HW reset (active low). Pull the nRESET pin low for minimum 100mS in order for the BL652 to reset.

## 5.11 nAutoRUN pin

Refer to *nAutoRUN pin and Operating Modes* regarding operating modes and the nAutoRUN pin.

- Self-contained Run mode
- Interactive/Development mode

## 5.12 vSP Command Mode

This section discusses VSP Command mode through pulling SIO\_2 high and nAutoRUN low. Read this section in conjunction with the *VSP Configuration* chapter of the BL652 *smartBASIC* Extensions Guide, found in the documentation tab of the **BL652 product page**.

Figure 7 shows the difference between VSP Bridge to UART mode and VSP Command mode and how SIO\_02 and nAutoRUN must be configured to select between these two modes.

- **VSP Bridge to UART mode** takes data sent from phone or tablet (over BLE) and sends to BL652 to be sent out of the BL652 UART (therefore data not stored on BL652).
- **VSP Command mode** takes data sent from phone or tablet and sends to BL652 which will interpret as an AT command and response will be sent back. The OTA Android or iOS application can be used to download any *smartBASIC* application script over the air to the BL652 because a *smartBASIC* application is downloaded using AT commands.



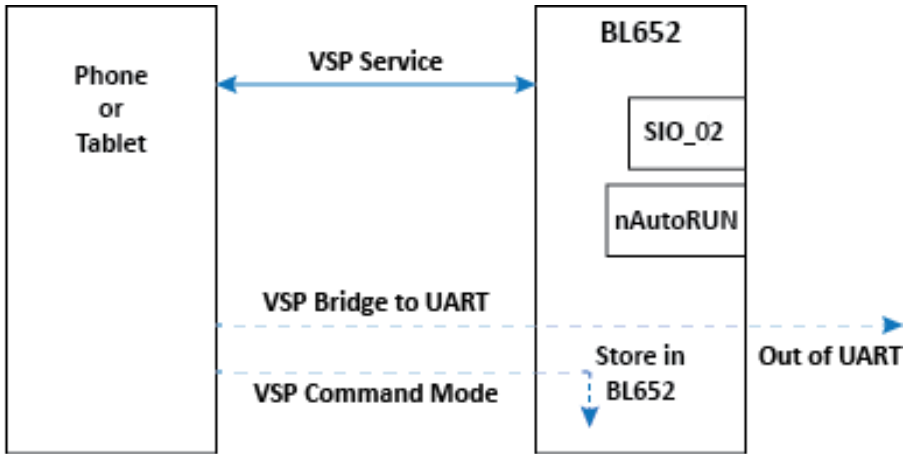

Figure 7: Differences between VSP bridge to UART mode and VSP Command mode

Table 25: vSP modes

Mode	SIO_02	nAutoRUN
VSP Bridge to UART Mode	High	High
VSP Command Mode	High	Low

SIO\_02 High (externally) selects the VSP service. When SIO\_02 is High and nAutoRUN is Low (externally), this selects VSP Command mode. When SIO\_02 is High and nAutoRUN is High (externally), this selects VSP Bridge to UART mode.

When SIO\_02 on module is set HIGH (externally), VSP is enabled and auto-bridged to UART when connected. However, for VSP Command mode, auto-bridge to UART is not required. With SIO\_02 set to High and nAutoRUN set to Low, the device enters VSP Command mode and you can then download the *smartBASIC* application onto the module over the air from the phone (or tablet).

### 5.13 Two-wire Interface JTAG

The BL652 Firmware hex file consists of four elements:

- *smartBASIC* runtime engine
- Softdevice
- Master Bootloader

Laird BL652 *smartBASIC* firmware (FW) image part numbers are referenced as w.x.y.z (ex. v28.x.y.z). The BL652*smartBASIC* runtime engine and Softdevice combined image can be upgraded by the customer over the UART interface.

You also have the option to use the two-wire (JTAG) interface, during production, to clone the file system of a Golden preconfigured BL652 to others using the Flash Cloning process. This is described in the app note [Flash Cloning for the BL652](#). In this case the file system is also part of the .hex file.

Signal Name	Pin No	I/O	Comments
SWDIO	5	I/O	Internal pull-up resistor
SWDCLK	6	I	Internal pull-down resistor

The Laird DVK-BL652 development board incorporates an on-board JTAG J-link programmer for this purpose. There is also the following JTAG connector which allows on-board JTAG J-link programmer signals to be routed off the development board. The only requirement is that you should use the following JTAG connector on the host PCB.

The JTAG connector MPN is as follows:

Reference	Part	Description and MPN (Manufacturers Part Number)
JP1	FTSH-105	Header, 1.27mm, SMD, 10-way, FTSH-105-01-L-DV Samtech

**Note:** Reference on the BL652 development board schematic (Figure 8) shows the DVK-BL652-xx development schematic wiring only for the JTAG connector and the BL652 module JTAG pins.

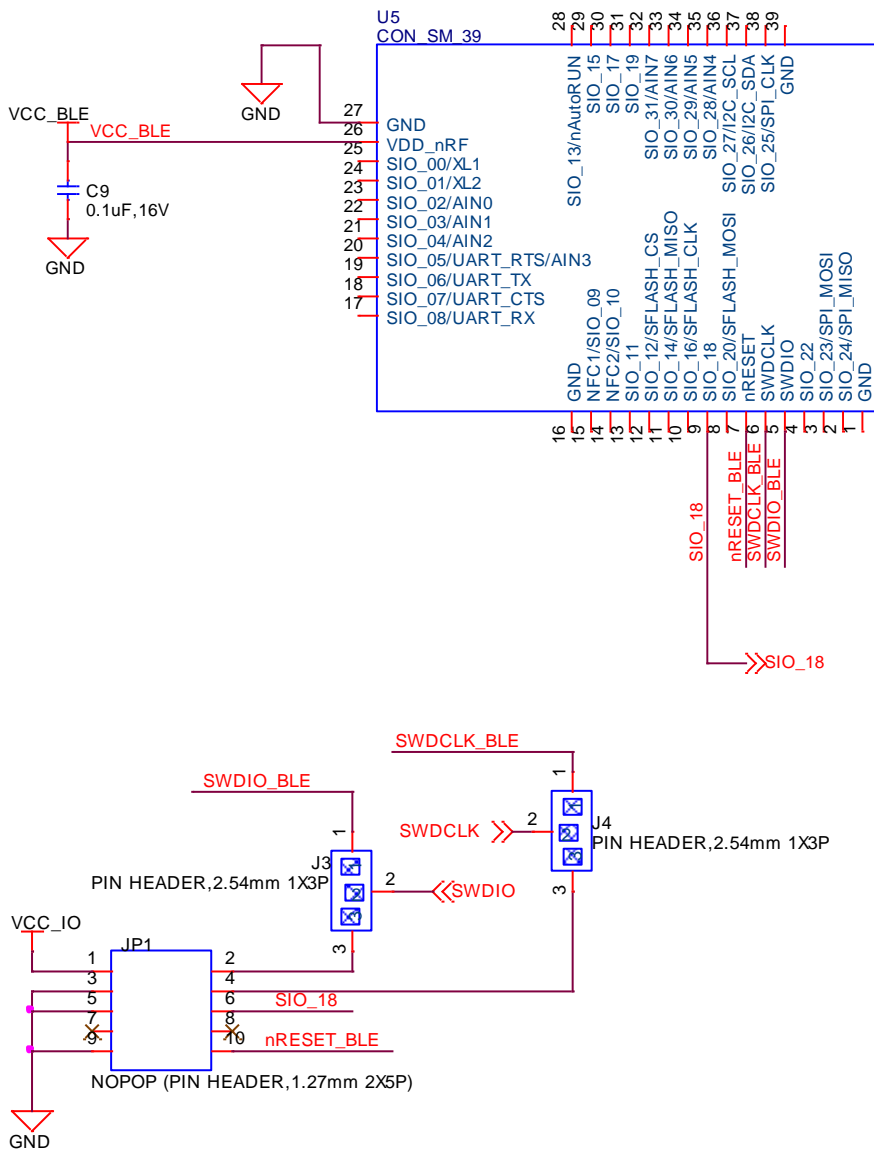

**Figure 8: BL652 development board schematic**

---

**Note:** J3 and J4 (on the DVK-BL652-xx development board) allows Laird on-board JTAG J-link programmer signals to be routed off the development board by fitting jumpers in the J3 pins (2-3) and J4 pins (2-3).

---

Laird recommends you use JTAG (2-wire interface) to handle future BL652 module firmware upgrades. You **MUST** wire out the JTAG (2-wire interface) on your host design (see [Figure 8](#), where four lines should be wired out, namely SWDIO, SWDCLK, GND and VCC). Firmware upgrades can still be performed over the BL652 UART interface, but this is slower (60 seconds using UART vs. 10 seconds when using JTAG) than using the BL652 JTAG (2-wire interface).

SIO\_18 is a Trace output (called SWO, Serial Wire Output) and is not necessary for programming BL652 over the SWD interface.

nReset\_BLE is not necessary for programming BL652 over the SWD interface.

## 5.14 BL652 Wakeup

### 5.14.1 Waking Up BL652 from Host

Wake the BL652 from the host using wake-up pins (any SIO pin). Refer to the *smartBASIC* user guide for details. You may configure the BL652's wakeup pins via *smartBASIC* to do any of the following:

- Wake up when signal is low
- Wake up when signal is high
- Wake up when signal changes

Refer to the *smartBASIC* user guide for details. You can access this guide from the Laird BL652 product page.

## 5.15 Low Power Modes

The BL652 has three power modes: Run, Standby Doze, and Deep Sleep.

The module is placed automatically in Standby Doze if there are no pending events (when WAITEVENT statement is encountered within a customer's *smartBASIC* script). The module wakes from Standby Doze via any interrupt (such as a received character on the UART Rx line). If the module receives a UART character from either the external UART or the radio, it wakes up.

Deep sleep is the lowest power mode. Once awakened, the system goes through a system reset.

## 5.16 Temperature Sensor

The on-silicon temperature sensor has a temperature range greater than or equal to the operating temperature of the device. Resolution is 0.25 degrees.

To read temperature from on-silicon temperature sensor (in tenth of centigrade, so 23.4°C is output as 234):

- In command mode, use **ATI2024**  
or
- From running from a running *smartBASIC* application script, use **SYSINFO(2024)**

## 5.17 Random Number Generator

Exposed via an API in *smartBASIC* (see *smartBASIC* documentation available from the BL652 product page).

The **rand()** function from a running *smartBASIC* application returns a value.

## 5.18 AES Encryption/Decryption

Exposed via an API in *smartBASIC* (see *smartBASIC* documentation available from the BL652 product page).

Function called **aesencrypt** and **aesdecrypt**.

## 5.19 Optional External Serial (SPI) Flash

This is not required for normal BL652 module operation.

If you fit an optional external serial (SPI) flash (such as for data logging purpose) then that external serial (SPI) flash must connect to BL652 module pins SIO\_12 (SFLASH\_CS), SIO\_14 (SFLASH\_MISO), SIO\_16 (SFLASH\_CLK), and SIO\_20 (SFLASH\_MOSI); in that case a high level API in *smartBASIC* can be used for fast access using open/close /read/write API functions.

---

**Note:** By default, these are GPIO pins. Only when in their FlashOpen()*smartBASIC* app are these lines dedicated to SPI and for talking to the off-module board SPI flash.

---

If you decide to use external serial (SPI) flash with the BL652-SX-xx, then ONLY the manufacturer part numbers below MUST be used:

- **4-Mbit Macronix MX25R4035F**  
<http://www.macronix.com/Lists/DataSheet/Attachments/3288/MX25R4035F,%20Wide%20Range,%204Mb,%20v1.2.pdf>
- **8-Mbit Macronix MX25R8035F**  
<http://www.macronix.com/Lists/DataSheet/Attachments/3532/MX25R8035F,%20Wide%20Range,%208Mb,%20v1.2.pdf>

For any external serial (SPI) flash other than these part numbers, *smartBASIC* does not provide access.

## 5.20 Optional External 32.768 kHz crystal

This is not required for normal BL652 module operation.

The BL652 uses the on-chip 32.76 kHz RC oscillator (LFCLK) by default (which has an accuracy of  $\pm 250$  ppm) which requires regulator calibration (every eight seconds) to within  $\pm 250$  ppm.

You can connect an optional external high accuracy ( $\pm 20$  ppm) 32.768 kHz crystal to the BL652-SX-xx pins, SIO\_01/XL2 (pin 24) and SIO\_00/XL1 (pin 25) to provide improved protocol timing and to help with radio power consumption in the system standby doze/deep sleep modes by reducing the time that the RX window needs to be open. [Table 26](#) compares the current consumption difference between RC and crystal oscillator.

**Table 26: Comparing current consumption difference between BL652 on-chip RC 32.76 kHz oscillator and optional external crystal (32.768kHz) based oscillator**

	<b>BL652 On-chip 32.768 kHz RC Oscillator (±250 ppm) LFRC</b>	<b>Optional External Higher Accuracy (±20 ppm) 32.768 kHz Crystal-based Oscillator XO</b>
<b>Current Consumption of 32.768 kHz Block</b>	0.6 uA	0.25 uA
<b>Standby Doze Current</b>	2.0 uA	2.0 uA
<b>Calibration</b>	<p>Calibration required regularly (default eight seconds interval)</p> <p>Calibration takes 16-17 ms; with DCDC used, the total charge of a calibration event is 7.4 uC.</p> <p>The average current consumed by the calibration depends on the calibration interval and can be calculated using the following formula:</p> $\text{CAL\_charge/CAL\_interval}$ <p>The lowest calibration interval (0.25 seconds) provides an average current of (DCDC enabled):</p> $7.4\mu\text{C} / 0.25\text{s} = 29.6\mu\text{A}$ <p>To get the 250 ppm accuracy, the BLE stack specification states that a calibration interval of eight seconds is enough. This gives an average current of:</p> $7.4\mu\text{C} / 8\text{s} = 0.93 \mu\text{A}$ <p>Added to the LFRC run current and Standby Doze (IDLE) base current shown above results in a total average current of:</p> $\text{LFRC} + \text{CAL} = 1.8 + 0.93 = 2.7\mu\text{A}$	Not applicable
<b>Total</b>	2.7 uA	1.45 uA
<b>Summary</b>	<ul style="list-style-type: none"> <li>▪ Low current consumption</li> <li>▪ Accuracy 250 ppm</li> </ul>	<ul style="list-style-type: none"> <li>▪ Lowest current consumption</li> <li>▪ Needs external crystal</li> <li>▪ High accuracy (depends on the crystal, usually 20 ppm)</li> </ul>

**Table 27: Optional external 32.768 kHz crystal specification**

Optional external 32.768kHz crystal	Min	Typ	Max
Crystal Frequency	-	32.768 kHz	-
Frequency tolerance requirement of BLE stack	-	-	±250 ppm
Load Capacitance	-	-	12.5 pF
Shunt Capacitance	-	-	2 pF
Equivalent series resistance	-	-	100 kOhm
Drive level	-	-	1 uW
Input capacitance on XL1 and XL2 pads	-	4 pF	-
Run current for 32.768 kHz crystal based oscillator	-	0.25 uA	-
Startup time for 32.768 kHz crystal based oscillator	-	0.25 seconds	-
Peak to peak amplitude for external low swing clock input signal must not be outside supply rails	200 mV	-	1000 mV

Be sure to tune the load capacitors on the board design to optimize frequency accuracy (at room temperature) so it matches that of the same crystal standalone, Drive Level (so crystal operated within safe limits) oscillation margin ( $R_{neg}$  is at least 3 to 5 times ESR) over the operating temperature range.

### 5.21 BL652-SA On-board Chip Antenna Characteristics

The BL652-SA on-board chip monopole antenna radiated performance depends on the host PCB layout.

The BL652 development board was used for BL652 development and antenna performance evaluation. To obtain similar performance, follow guidelines in section *PCB Layout on Host PCB for BL652-SA* to allow the on-board antenna to radiate and reduce proximity effects due to nearby host PCB GND copper or metal covers.

BL652-SA on-board chip antenna datasheet: [http://www.acxc.com.tw/product/at/at3216/AT3216-B2R7HAA\\_S-R00-N198\\_2.pdf](http://www.acxc.com.tw/product/at/at3216/AT3216-B2R7HAA_S-R00-N198_2.pdf)

Unit in dBi @2.44GHz	XY-plane		XZ-plane		YZ-plane		Efficiency
	Peak	Avg	Peak	Avg	Peak	Avg	
AT3216-B2R7HAA	-5.1	-8.7	-1.3	-7.4	-5.1	-8.7	25.0%

◆XY-plane

Far-field Power Distribution(H+V) on X-Y Plane  
Plot Peak Gain(H+V)=-5.1 dB; Plot AvgGain(H+V)=-8.7dB @2.44000 GHz

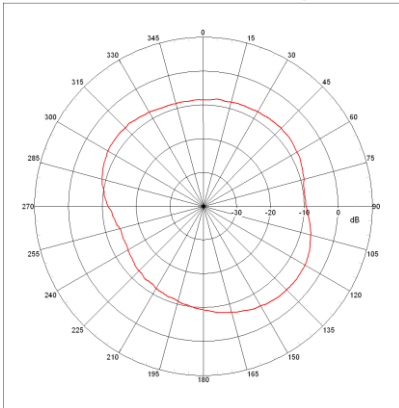

◆XZ-plane

Far-field Power Distribution(H+V) on X-Z Plane  
Plot Peak Gain(H+V)=-1.3 dB; Plot AvgGain(H+V)=-7.4dB @2.44000 GHz

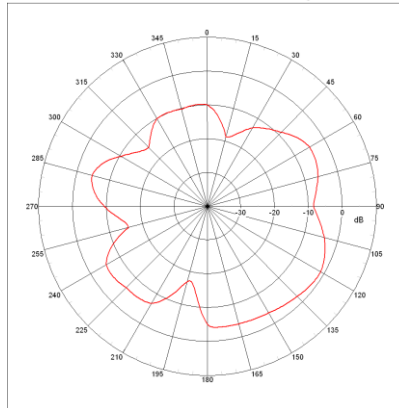

◆YZ-plane

Far-field Power Distribution(H+V) on Y-Z Plane  
Plot Peak Gain(H+V)=-1.2 dB; Plot AvgGain(H+V)=-7.4dB @2.44000 GHz

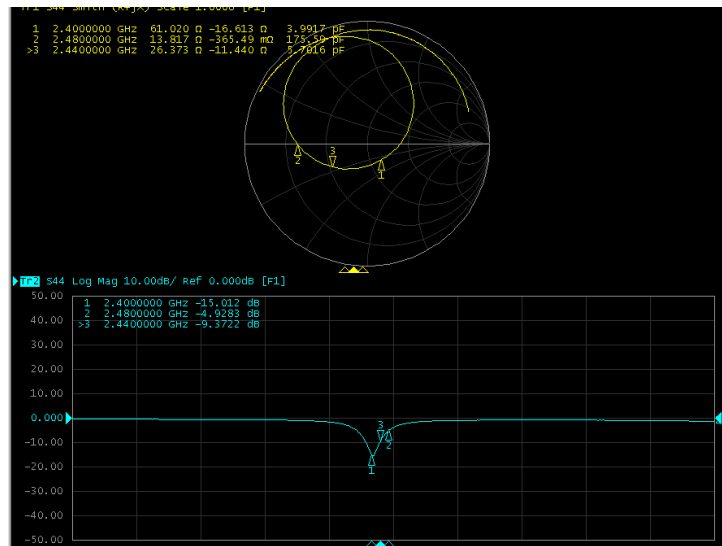
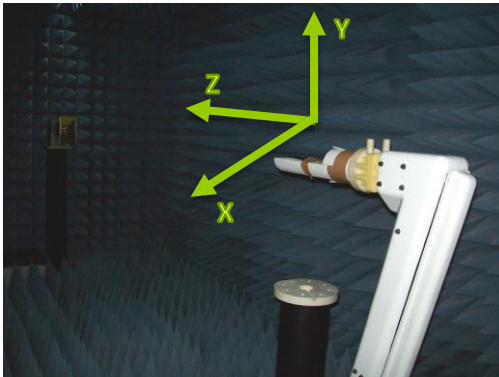
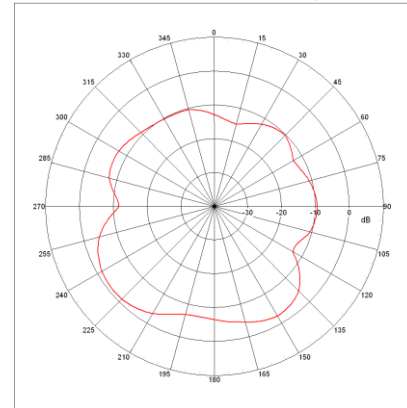

Figure 9: BL652-SA on-board chip antenna performance (Antenna Gain, efficiency and S11 (whilst BL652-SA-xx module on DVK-BL652-xx development board)

## 6 HARDWARE INTEGRATION SUGGESTIONS

### 6.1 Circuit

The BL652 is easy to integrate, requiring no external components on your board apart from those which you require for development and in your end application.

The following are suggestions for your design for the best performance and functionality.

#### Checklist (for Schematic):

- VCC pins**  
 External power source should be within the operating range, rise time and noise/ripple specification of the BL652. Add decoupling capacitors for filtering the external source. Power-on reset circuitry within BL652

series module incorporates brown-out detector, thus simplifying your power supply design. Upon application of power, the internal power-on reset ensures that the module starts correctly.

- **VCC and coin-cell operation**

With built-in DCDC (operating range 1.7V to 3.6V), reduces the peak current required from a coin-cell (CR2032), making it easier to use with coin-cell.

- **AIN (ADC) and SIO pin IO voltage levels**

BL652 SIO voltage levels are at VCC. Ensure input voltage levels into SIO pins are at VCC also (if VCC source is a battery whose voltage will drop). Ensure ADC pin maximum input voltage for damage is not violated.

- **AIN (ADC) impedance and external voltage divider setup**

If you need to measure with ADC a voltage higher than 3.6V, you can connect a high impedance voltage divider to lower the voltage to the ADC input pin.

- **JTAG**

This is **REQUIRED** as *smartBASIC* runtime engine firmware can be loaded using the JTAG (as well as the UART.)

Laird recommends you use JTAG (2-wire interface) to handle future BL652 module firmware upgrades. You **MUST** wire out the JTAG (2-wire interface) on your host design (see Figure 8, where four lines should be wired out, namely SWDIO, SWDCLK, GND and VCC). Firmware upgrades can still be performed over the BL652 UART interface, but this is slower (60 seconds using UART vs. 10 seconds when using JTAG) than using the BL652 JTAG (2-wire interface).

JTAG may be used if you intend to use Flash Cloning during production to load *smartBASIC* scripts.

- **UART**

Required for loading your *smartBASIC* application script during development (or for subsequent firmware upgrades (except JTAG for FW upgrades and/or Flash Cloning of the *smartBASIC* application script). Add connector to allow interfacing with UART via PC (UART-RS232 or UART-USB).

- **UART\_RX and UART\_CTS**

SIO\_8 (alternative function UART\_RX) is an input, set with internal weak pull-up (in firmware). The pull-up prevents the module from going into deep sleep when UART\_RX line is idling.

SIO\_7 (alternative function UART\_CTS) is an input, set with internal weak pull-down (in firmware). This pull-down ensures the default state of the UART\_CTS will be asserted which means can send data out of the UART\_TX line. Laird recommends that UART\_CTS be connected.

- **nAutoRUN pin and operating mode selection**

nAutoRUN pin needs to be externally held high or low to select between the two BL652 operating modes at power-up:

- Self-contained Run mode (nAutoRUN pin held at 0V).
- Interactive / development mode (nAutoRUN pin held at VCC).

Make provision to allow operation in the required mode. Add jumper to allow nAutoRUN pin to be held high or low (BL652 has internal 13K pull-down by default) OR driven by host GPIO.

- **I2C**

It is essential to remember that pull-up resistors on both I2C\_SCL and I2C\_SDA lines are not provided in the BL652 module and **MUST** be provided external to the module as per I2C standard.

- **SPI**

Implement SPI chip select using any unused SIO pin within your *smartBASIC* application script then SPI\_CS is controlled from *smartBASIC* application allowing multi-dropping.

- **SIO pin direction**

BL652 modules shipped from production with *smartBASIC* runtime engine FW, all SIO pins (with default function of DIO) are mostly digital inputs (see Pin Definitions Table2). Remember to change the direction SIO



pin (in your *smartBASIC* application script) if that particular pin is wired to a device that expects to be driven by the BL652 SIO pin configured as an output. Also, these SIO pins have the internal pull-up or pull-down resistor-enabled by default in firmware (see Pin Definitions Table 2). This was done to avoid floating inputs, which can cause current consumption in low power modes (e.g. StandbyDoze) to drift with time. You can disable the PULL-UP or Pull-down through their *smartBASIC* application.

---

**Note:** Internal pull-up, pull down will take current from VCC.

---

- **SIO\_02 pin** and OTA *smartBASIC* application download feature

SIO\_02 is an input, set with internal pull-down (in FW). Refer to latest firmware release documentation on how SIO\_02 is used for Over the Air *smartBASIC* application download feature. SIO\_02 pin has to be pulled high externally to enable the feature. Decide if this feature is required in production. When SIO\_02 is high, ensure nAutoRun is NOT high at same time; otherwise you cannot load the *smartBASIC* application script.

- **NFC antenna connector**

To make use of the Laird flexi-PCB NFC antenna, fit connector:

Description: FFC/FPC Connector, Right Angle, SMD/90d, Dual Contact, 1.2 mm Mated Height

Manufacturer: Molex

Manufacturers Part number: 512810594

Add tuning capacitors of 300 pF on NGC1 pin to GND and 300 pF on NFC2 pins to GND if the PCB track length is similar as DVK-BL652 devboard.

- **nRESET pin (active low)**

Hardware reset. Wire out to push button or drive by host.

By default module is out of reset when power applied to VCC pins.

- **Optional External 32.768kHz crystal**

If the optional external 32.768kHz crystal is needed then use a crystal that meets specification.

- **Optional External serial SPI flash IC**

If the optional external serial (SPI) flash is required, ensure that manufacturer part number tested by Laird are used.

## 6.2 PCB Layout on Host PCB - General

### Checklist (for PCB):

- MUST locate BL652-Sx module close to the edge of PCB (mandatory for BL652-SA for on-board chip antenna to radiate properly).
- Use solid GND plane on inner layer (for best EMC and RF performance).
- All module GND pins MUST be connected to host PCB GND.
- Place GND vias close to module GND pads as possible.
- Unused PCB area on surface layer can be flooded with copper but place GND vias regularly to connect copper flood to inner GND plane. If GND flood copper underside the module then connect with GND vias to inner GND plane.
- Route traces to avoid noise being picked up on VCC supply and AIN (analogue) and SIO (digital) traces.
- Ensure no exposed copper is on the underside of the module (refer to land pattern of BL652 development board).

## 6.3 PCB Layout on Host PCB for BL652-SA

### 6.3.1 Antenna Keep-out on Host PCB

The BL652-SA has an integrated chip antenna and its performance is sensitive to host PCB. It is critical to locate the BL652-SA on the edge of the host PCB (or corner) to allow the antenna to radiate properly. Refer to guidelines in section **PCB land pattern and antenna keep-out area for BL652-SA**. Some of those guidelines repeated below.

- Ensure there is no copper in the antenna keep-out area on any layers of the host PCB. Keep all mounting hardware and metal clear of the area to allow proper antenna radiation.
- For best antenna performance, place the BL652-SA module on the edge of the host PCB, preferably in the corner with the antenna facing the corner.
- The BL652 development board has the BL652-SA module on the edge of the board (not in the corner). The antenna keep-out area is defined by the BL652 development board which was used for module development and antenna performance evaluation is shown in [Figure 10](#), where the antenna keep-out area is ~4.95mm wide, 25.65 mm long; with PCB dielectric (no copper) height 0.85 mm sitting under the BL652-SA antenna.
- The BL652-SA antenna is tuned when BL652-SA is sitting on development board (host PCB) with size of 120 mm x 93 mm.
- A different host PCB thickness dielectric will have small effect on antenna.
- The antenna-keep-out defined in the [Host PCB Land Pattern and Antenna Keep-out for BL652-SA](#) section.
- Host PCB land pattern and antenna keep-out for the BL652 applies when the BL652-SA is placed in the corner of the host PCB. When BL652-SA cannot be placed as such, it must be placed on the edge of the host PCB and the antenna keep out must be observed. [Figure 10](#) shows an example.

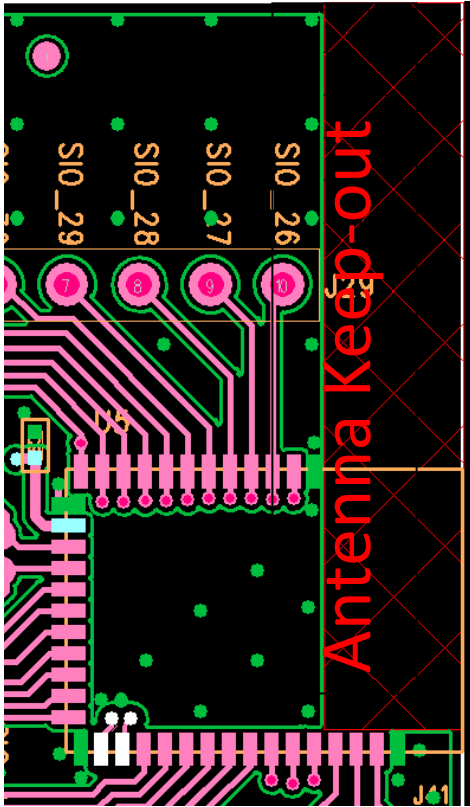

Figure 10: Antenna keep-out area (shown in red), corner of the BL652 development board for BL652-SA module.

**Antenna Keep-out Notes:**

- Note 1** | The BL652 module is placed on the edge of the host PCB.
- Note 2** | Copper cut-away on all layers in the *Antenna Keep-out* area under BL652 on host PCB.

**6.3.2 Antenna Keep-out and Proximity to Metal or Plastic**

**Checklist (for metal /plastic enclosure):**

- Minimum safe distance for metals without seriously compromising the antenna (tuning) is 40 mm top/bottom and 30 mm left or right.
- Metal close to the BL652-SA chip monopole antenna (bottom, top, left, right, any direction) will have degradation on the antenna performance. The amount of that degradation is entirely system dependent, meaning you will need to perform some testing with your host application.
- Any metal closer than 20 mm will begin to significantly degrade performance (S11, gain, radiation efficiency).
- It is best that you test the range with a mock-up (or actual prototype) of the product to assess effects of enclosure height (and materials, whether metal or plastic).

## 6.4 External Antenna Integration with BL652-SC

Please refer to the regulatory sections for [FCC](#), [IC](#), [CE](#), and [Japan](#) for details of use of BL652-Sx with external antennas in each regulatory region.

The BL652 family has been designed to operate with the below external antennas (with a maximum gain of 2.0 dBi). The required antenna impedance is 50 ohms. See [Table 28](#). External antennas improve radiation efficiency.

Table 28: External antennas for the BL652

External Antenna Part Number	Laird Part Number	Mfg.	Type	Gain (dBi)	Connector Type	BL652 Part Number
FlexPIFA (001-0022)		LSR	PCB Dipole	2.0	IPEX-4 (See Note 1)	BL652-SC
mFlexPIFA	001-0030	Laird	PCB Dipole	2.0	IPEX U.FL	BL652-SC
FlexNotch (001-0023)		LSR	PCB Dipole	2.0	IPEX-4 (See Note 1)	BL652-SC
EDA-8709-2G4C1-B27-CY		Mag.Layers	Dipole	2.0	IPEX-4 (See Note 1)	BL652-SC
RFDPA870910EMAB302	0600-00057	Walsin	Dipole	2.0	IPEX-4 (See Note 1)	BL652-SC

**Note 1:** Integral RF co-axial cable (1.13 mm OD) with length 100±5 mm and IPEX-4 compatible connector. These antennas are available through Laird – please contact Sales for information.

## 7 MECHANICAL DETAILS

### 7.1 BL652 Mechanical Details

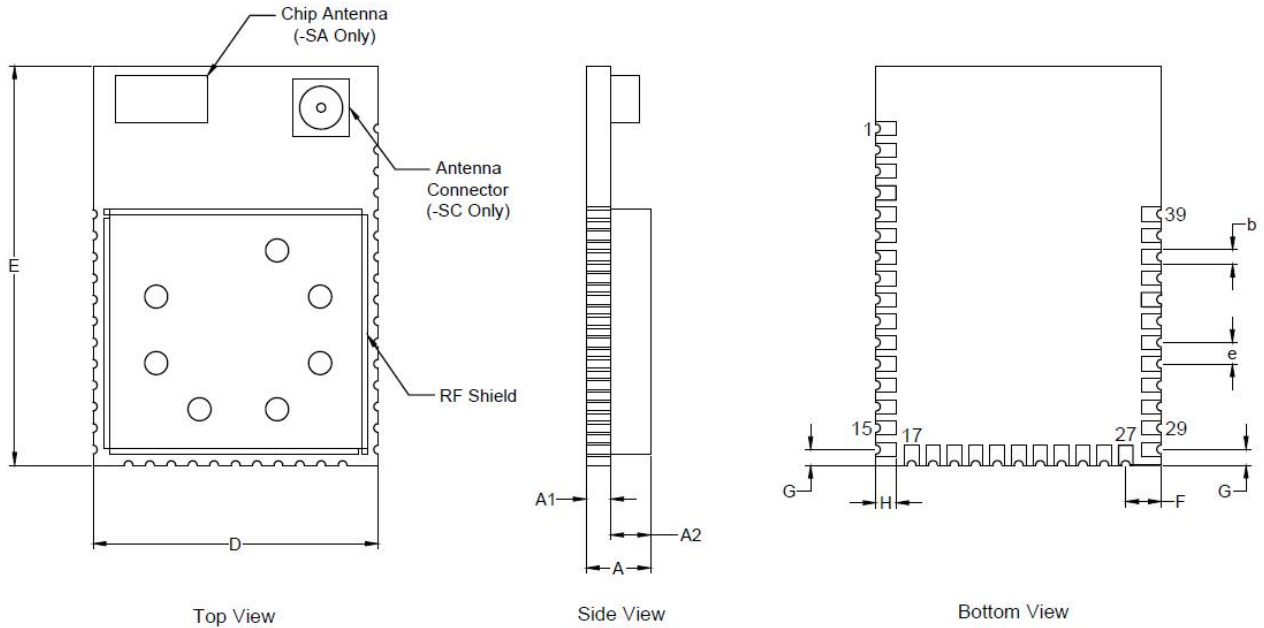

Description	BL652 A1			
Size	14.0 x 10.0 x 2.1 mm			
Pitch	0.75mm			
Dimension	Minimum	Typical	Maximum	Notes
A		2.1		
A1	0.50	0.60	0.70	PCB Thickness
A2		1.5		RF Shield Height
b		0.5		Global pad width
D	9.87	10.0	10.13	
E	13.87	14.0	14.13	
e		0.75		Global pitch
F		1.25		Pad Center to Board edge
G		0.55		Pad Center to Board edge
H		0.7		Global length of pad to edge of board
Units	mm			

Laird			
Module Package Dimensions			
TOLERANCE (UNLESS STATED)	MATERIAL	DRAWN	S Query
x +/- 0.3	x.xxx +/- 0.03	FINISH	CHECKED
x.x +/- 0.1		COLOR	APPROVED
DIMENSIONS IN MM (UNLESS STATED)	SCALE	THIRD ANGLE PROJECTION	DWG No: BL652 A1 Page 1 of 1
PROJECT	BL652 A1		

**Figure 11: BL652 mechanical drawings**

Development Kit Schematics can be found in the software downloads tab of the BL652 product page:

<http://www.lairdtech.com/Products/BL652-Series>

## 7.2 Host PCB Land Pattern and Antenna Keep-out for BL652-SA

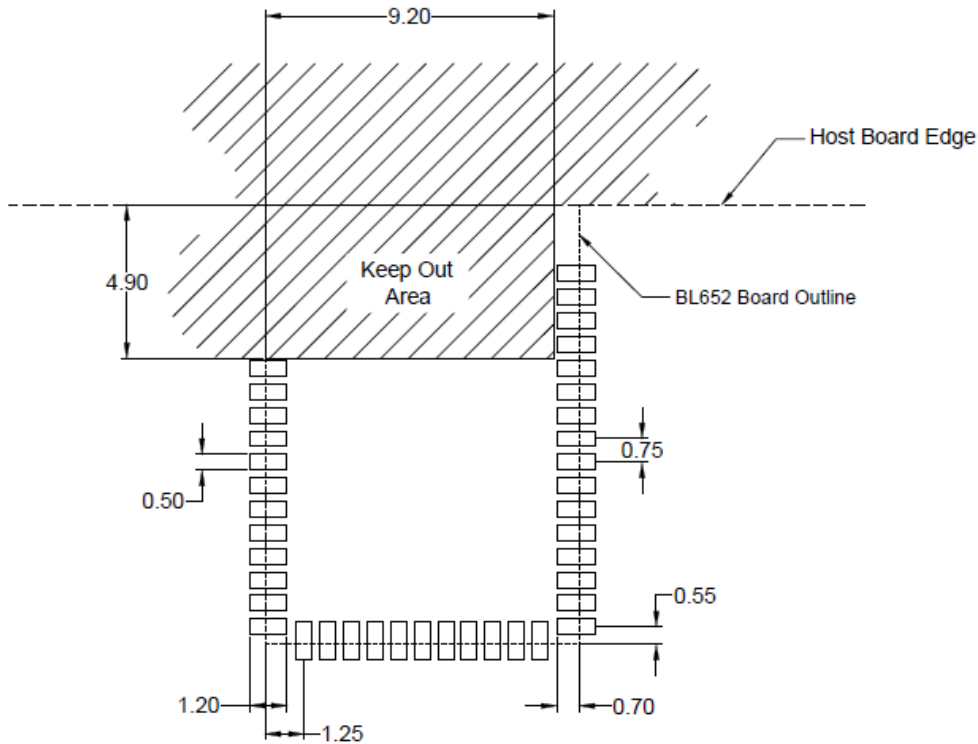

Figure 12: Land pattern and Keep-out for BL652-SA

All dimensions are in mm.

### Host PCB Land Pattern and Antenna Keep-out for BL652-SANotes:

- Note 1** Ensure there is no copper in the antenna 'keep out area' on any layers of the host PCB. Also keep all mounting hardware or any metal clear of the area (Refer to 6.3.2) to reduce effects of proximity detuning the antenna and to help antenna radiate properly.
- Note 2** For the best on-board antenna performance, the module BL652-SA MUST be placed on the edge of the host PCB and preferably in the corner with the antenna facing the corner. Above "Keep Out Area" is the module placed in corner of PCB. If BL652-SA is not placed in corner but on edge of host PCB, the antenna "Keep Out Area" is extended (see Note 4).
- Note 3** BL652 development board has BL652-SA placed on the edge of the PCB board (and not in corner) for that the Antenna keep out area is extended down to the corner of the development board, see section [PCB Layout on Host PCB for BL652-SA](#), Figure 12. This was used for module development and antenna performance evaluation.
- Note 4** Ensure that there is no exposed copper under the module on the host PCB.
- Note 5** You may modify the PCB land pattern dimensions based on their experience and/or process capability.

## 8 APPLICATION NOTE FOR SURFACE MOUNT MODULES

### 8.1 Introduction

Laird Technologies surface mount modules are designed to conform to all major manufacturing guidelines. This application note is intended to provide additional guidance beyond the information that is presented in the User Manual. This Application Note is considered a living document and will be updated as new information is presented.

The modules are designed to meet the needs of several commercial and industrial applications. They are easy to manufacture and conform to current automated manufacturing processes.

### 8.2 Shipping

#### 8.2.1 Tape and Reel Package Information

**Note:** Ordering information for tape and reel packaging involves the addition of T/R to the end of the full module part number. For example, BL652-SA-0x becomes BL652-SA-0x-T/R.

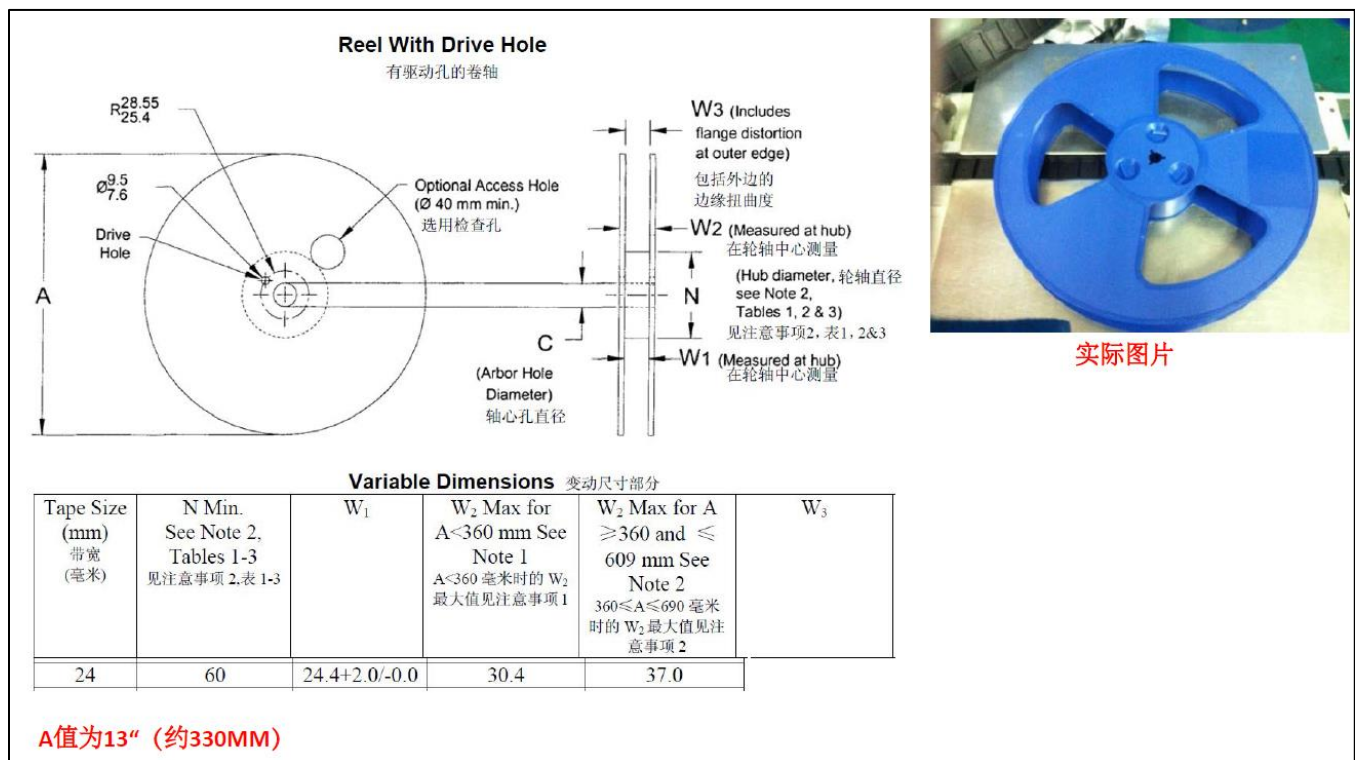
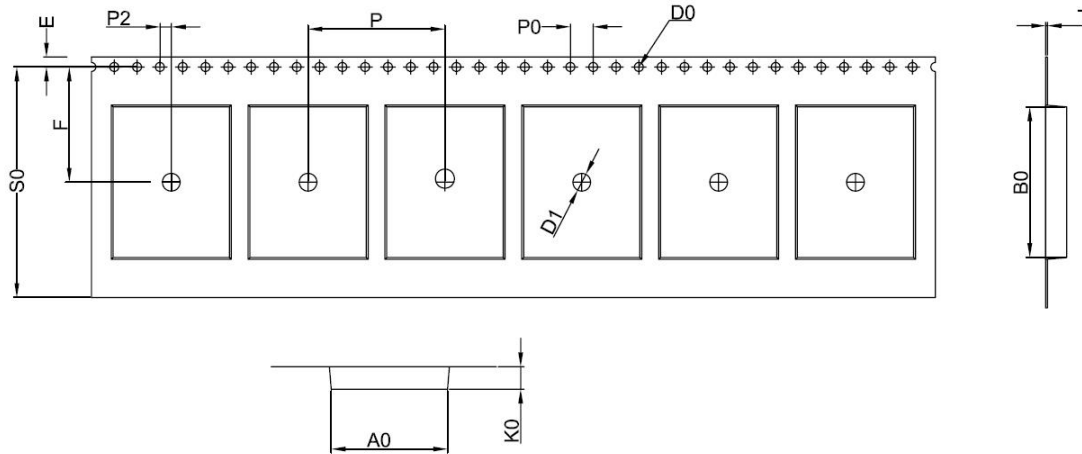

Figure 13: Reel specifications

ITRM	W	A0	B0	K0	K1	P	F	E	S0	D0	D1	P0	P2	T	13" 环保卷轮	
DIM	24.00	10.30	14.30	2.40	--	16.00	11.50	1.75	22.25	1.50	1.50	4.00	2.00	0.35	长度/盘	元件/盘
TOLE	+0.30 -0.30	+0.30 -0.0	+0.30 -0.0	+0.20 -0.00	+0.10 -0.10	+0.10 -0.10	+0.10 -0.10	+0.10 -0.10	+0.10 -0.10	+0.10 -0.00	+0.10 -0.00	+0.10 -0.10	+0.10 -0.10	+0.05 -0.05	25M	1000pcs



- 备注: (1) 任意10个焊孔的累计误差不得超过 $\pm 0.20\text{mm}$ 。  
 (2) 载带长度方向100mm 距离的非平行度不得超过 1mm。 超过250mm 不算累计误差。  
 (3) 非指明公差范围为:  $\pm 0.20\text{mm}$ 。  
 (4) A0, B0 为型腔内底部尺寸, K0 为内部尺寸。  
 (5) 材料厚度 T 以在载带边缘测量为准, 须打中孔。  
 (6) 材质黑色防静电。

Title <b>BL652 Shipping Tape</b>		
P/N: 45Y728-00100		Rev 1
Drawn by <b>wzr</b>	Date 7-Jul-2016	Sheet <b>1/1</b>

**Figure 14: Tape specifications**

There are 1000 BL652 modules taped in a reel (and packaged in a pizza box) and five boxes per carton (5000 modules per carton). Reel, boxes, and carton are labeled with the appropriate labels. See [Carton Contents](#) for more information.

### 8.2.2 Carton Contents

The following are the contents of the carton shipped for the BL652 modules.



PCBA: 5000 pcs/ctn

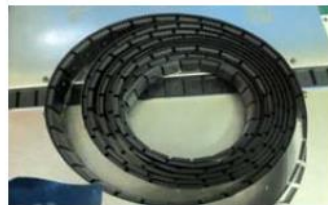

Tape: 1000 pcs PCBA/roll, 5 rolls/ctn



Reel: 5 pcs/ctn



Bag: 5 pcs/ctn



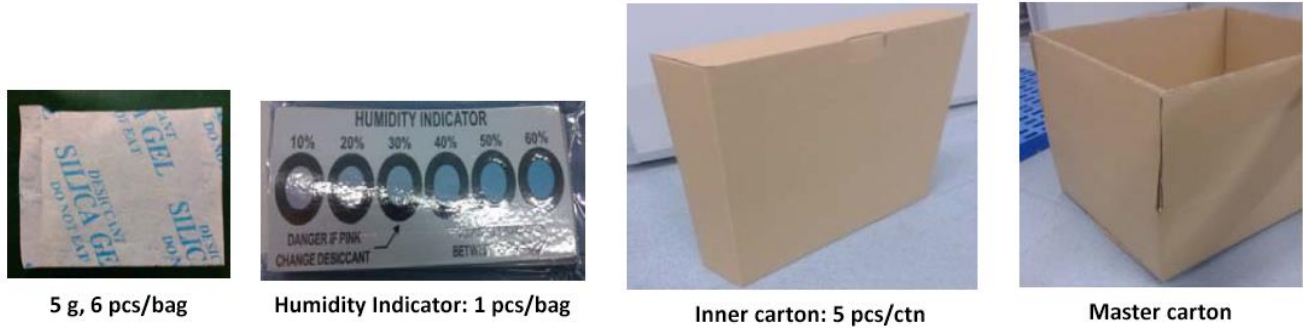

**Figure 15: Carton contents for the BL652**

### 8.2.3 Packaging Process

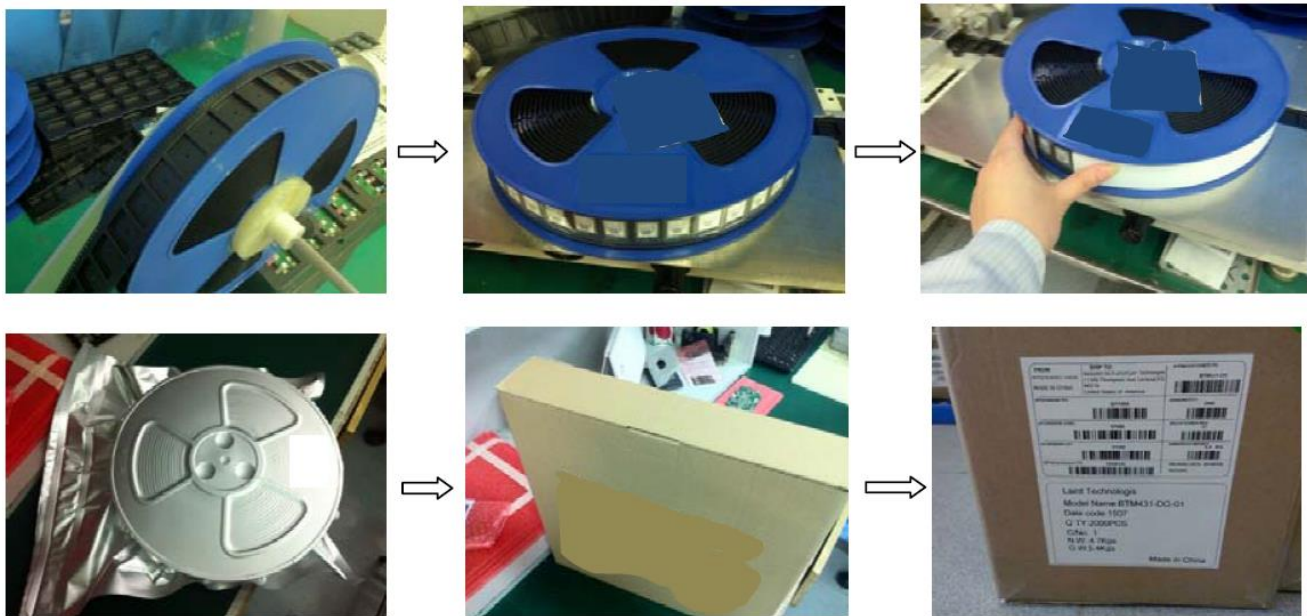

**Figure 16: BL652 packaging process**

### 8.2.4 Labeling

The following labels are located on the antistatic bag:



**Figure 17: Antistatic bag labels**

The following package label is located on both sides of the master carton:

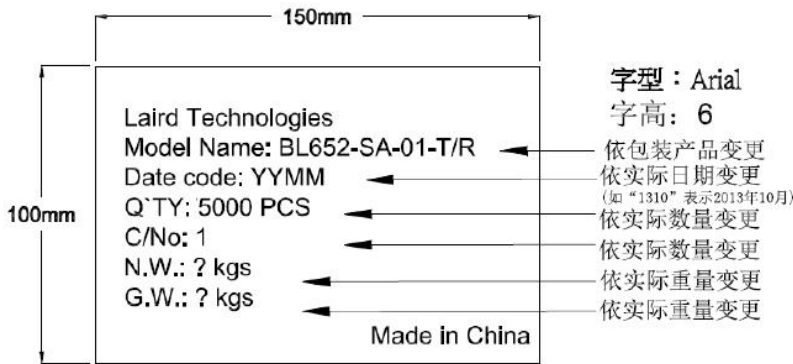

Figure 18: Master carton package label

The following is the packing slip label:

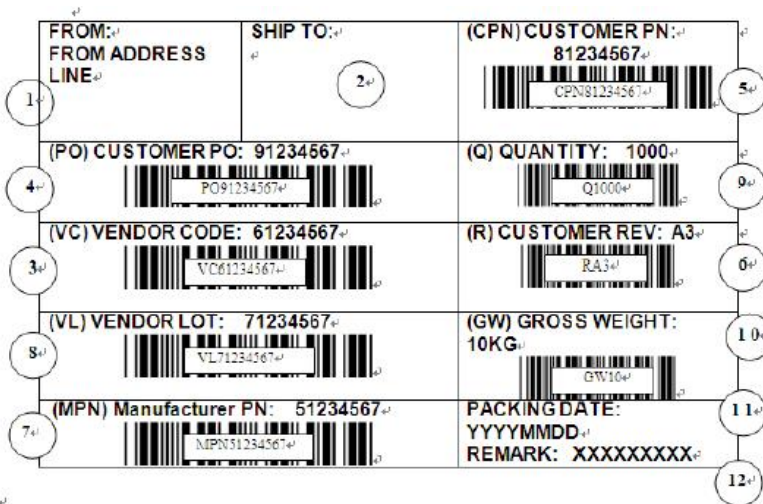

Figure 19: Packing slip label

### 8.3 Reflow Parameters

Prior to any reflow, it is important to ensure the modules were packaged to prevent moisture absorption. New packages contain desiccant (to absorb moisture) and a humidity indicator card to display the level maintained during storage and shipment. If directed to *bake units* on the card, see Table 29 and follow instructions specified by IPC/JEDEC J-STD-033. A copy of this standard is available from the JEDEC website:

<http://www.jedec.org/sites/default/files/docs/jstd033b01.pdf>

**Note:** The shipping tray cannot be heated above 65°C. If baking is required at the higher temperatures displayed in in Table 29, the modules must be removed from the shipping tray.

Any modules not manufactured before exceeding their floor life should be re-packaged with fresh desiccant and a new humidity indicator card. Floor life for MSL (Moisture Sensitivity Level) 3 devices is 168 hours in ambient environment ≤30°C/60%RH.

Table 29: Recommended baking times and temperatures

MSL	125 °C Baking Temp.		90 °C/≤ 5%RH Baking Temp.		40 °C/≤ 5%RH Baking Temp.	
	Saturated @ 30 °C/85%	Floor Life Limit + 72 hours @ 30 °C/60%	Saturated @ 30 °C/85%	Floor Life Limit + 72 hours @ 30 °C/60%	Saturated @ 30 °C/85%	Floor Life Limit + 72 hours @ 30 °C/60%
3	9 hours	7 hours	33 hours	23 hours	13 days	9 days

Laird surface mount modules are designed to be easily manufactured, including reflow soldering to a PCB. Ultimately it is the responsibility of the customer to choose the appropriate solder paste and to ensure oven temperatures during reflow meet the requirements of the solder paste. Laird surface mount modules conform to J-STD-020D1 standards for reflow temperatures.

Important: During reflow, modules should not be above 260° and not for more than 30 seconds.

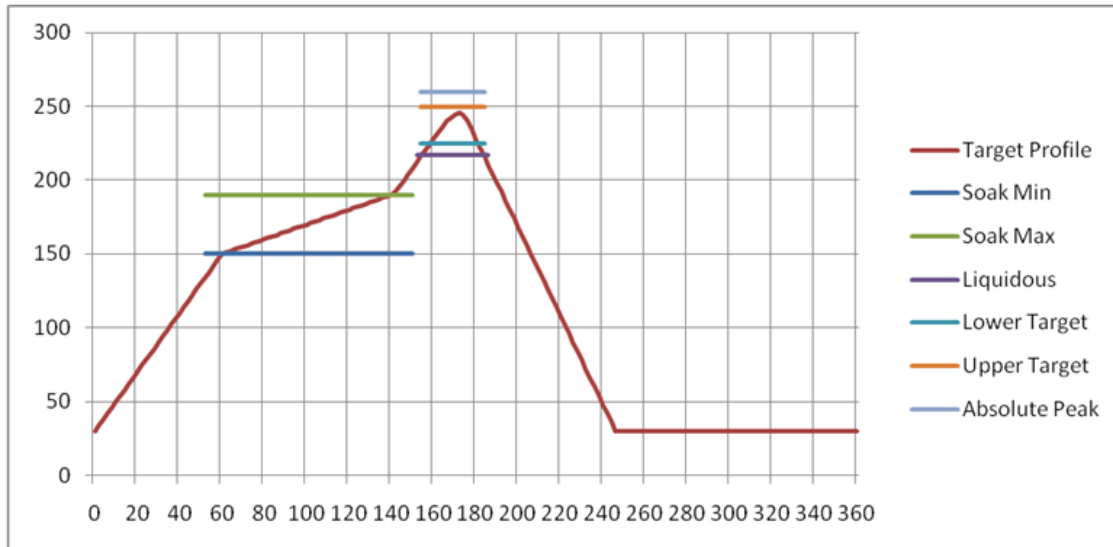

Figure 20: Recommended reflow temperature

Temperatures should not exceed the minimums or maximums presented in Table 30.

Table 30: Recommended maximum and minimum temperatures

Specification	Value	Unit
Temperature Inc./Dec. Rate (max)	1~3	°C / Sec
Temperature Decrease rate (goal)	2-4	°C / Sec
Soak Temp Increase rate (goal)	.5 - 1	°C / Sec
Flux Soak Period (Min)	70	Sec
Flux Soak Period (Max)	120	Sec
Flux Soak Temp (Min)	150	°C
Flux Soak Temp (max)	190	°C
Time Above Liquidous (max)	70	Sec

Specification	Value	Unit
Time Above Liquidous (min)	50	Sec
Time In Target Reflow Range (goal)	30	Sec
Time At Absolute Peak (max)	5	Sec
Liquidous Temperature (SAC305)	218	°C
Lower Target Reflow Temperature	240	°C
Upper Target Reflow Temperature	250	°C
Absolute Peak Temperature	260	°C

## 9 FCC AND IC REGULATORY STATEMENTS

Model	US/FCC	Canada/IC
BL652-SA	SQGBL652	3147A-BL652
BL652-SC	SQGBL652	3147A-BL652

The BL652SA and BL652-SC hold full modular approvals. The OEM must follow the regulatory guidelines and warnings listed below to inherit the modular approval.

Part #	Form Factor	Tx Outputs	Antenna
BL652-SA-xx	Surface Mount	4 dBm	Ceramic
BL652-SC-xx	Surface Mount	4 dBm	IPEX MHF4

\*Last two slots "XX" in Part # are used for production firmware release changes. Can be values 01-99, aa-zz

### 9.1 Antenna Information

The BL652 family has been designed to operate with the antennas listed below with a maximum gain of 2.21 dBi. The required antenna impedance is 50 ohms.

External Antenna Part Number	Laird Part Number	Mfg.	Type	Gain (dBi)	Connector Type	BL652 Part number
FlexPIFA	001-0022	LSR	PCB Dipole	2.0	IPEX-4	BL652-SC
mFlexPIFA	001-0030	Laird	PCB Dipole	2.0	IPEX U.FL	BL652-SC
FlexNotch	001-0023	LSR	PCB Dipole	2.0	IPEX-4	BL652-SC
EDA-8709-2G4C1-B27-CY		Mag.Layers	Dipole	2.0	IPEX-4	BL652-SC
RFDPA870910EMAB302	0600-00057	Walsin	Dipole	2.0	IPEX-4	BL652-SC

**Note:** The OEM is free to choose another vendor's antenna of like type and equal or lesser gain as an antenna appearing in the table and still maintain compliance. Reference FCC Part 15.204(c)(4) for further information on this topic.

To reduce potential radio interference to other users, the antenna type and gain should be chosen so that the equivalent isotropic radiated power (EIRP) is not more than that permitted for successful communication.

---

## 9.2 Power Exposure Information

Federal Communication Commission (FCC) Radiation Exposure Statement:

This EUT is in compliance with SAR for general population/uncontrolled exposure limits in ANSI/IEEE C95.1-1999 and had been tested in accordance with the measurement methods and procedures specified in OET Bulletin 65 Supplement C.

This transceiver must not be co-located or operating in conjunction with any other antenna, transmitter, or external amplifiers. Further testing / evaluation of the end product will be required if the OEM's device violates any of these requirements.

The BL652 is fully approved for mobile and portable applications.

## 9.3 OEM Responsibilities

---

**WARNING:** The OEM must ensure that FCC labelling requirements are met. This includes a clearly visible label on the outside of the OEM enclosure specifying the appropriate Laird Technology FCC identifier for this product.

Contains FCC ID: SQGBL652 IC: 3147A-BL652

If the size of the end product is larger than 8x10cm, then the following FCC part 15.19 statement has to also be available on visible on outside of device:

The enclosed device complies with Part 15 of the FCC Rules. Operation is subject to the following two conditions: (1) This device may not cause harmful interference, and (2) This device must accept any interference received, including interference that may cause undesired operation

---

Label and text information should be in a size of type large enough to be readily legible, consistent with the dimensions of the equipment and the label. However, the type size for the text is not required to be larger than eight point.

**CAUTION:** The OEM should have their device which incorporates the BL652 tested by a qualified test house to verify compliance with FCC Part 15 Subpart B limits for unintentional radiators.

**CAUTION:** Any changes or modifications not expressly approved by Laird Technology could void the user's authority to operate the equipment.

## 9.4 Federal Communication Commission Interference Statement

This equipment has been tested and found to comply with the limits for a Class B digital device, pursuant to Part 15 of the FCC Rules. These limits are designed to provide reasonable protection against harmful interference in a residential installation. This equipment generates, uses and can radiate radio frequency energy and, if not installed and used in accordance with the instructions, may cause harmful interference to radio communications. However, there is no guarantee that interference will not occur in a particular installation. If this equipment does

cause harmful interference to radio or television reception, which can be determined by turning the equipment off and on, the user is encouraged to try to correct the interference by one of the following measures:

- Reorient or relocate the receiving antenna.
- Increase the separation between the equipment and receiver.
- Connect the equipment into an outlet on a circuit different from that to which the receiver is connected.
- Consult the dealer or an experienced radio/TV technician for help.

**FCC Caution:** Any changes or modifications not expressly approved by the party responsible for compliance could void the user's authority to operate this equipment.

This device complies with Part 15 of the FCC Rules. Operation is subject to the following two conditions: (1) This device may not cause harmful interference, and (2) this device must accept any interference received, including interference that may cause undesired operation.

**IMPORTANT NOTE:**

**FCC Radiation Exposure Statement:**

The product complies with the US portable RF exposure limit set forth for an uncontrolled environment and are safe for intended operation as described in this manual. The further RF exposure reduction can be achieved if the product can be kept as far as possible from the user body or set the device to lower output power if such function is available.

This transmitter must not be co-located or operating in conjunction with any other antenna or transmitter.

**This device is intended only for OEM integrators under the following conditions:**

(1) The transmitter module may not be co-located with any other transmitter or antenna,

As long as the condition above is met, further transmitter test will not be required. However, the OEM integrator is still responsible for testing their end-product for any additional compliance requirements required with this module installed

**IMPORTANT NOTE**

In the event that these conditions can not be met (for example certain laptop configurations or co-location with another transmitter), then the FCC authorization is no longer considered valid and the FCC ID can not be used on the final product. In these circumstances, the OEM integrator will be responsible for re-evaluating the end product (including the transmitter) and obtaining a separate FCC authorization.

**End Product Labeling**

The end product must be labeled in a visible area with the following: "Contains FCC ID: SQGBL652".

**Manual Information to the End User**

The OEM integrator must be aware not to provide information to the end user regarding how to install or remove this RF module in the user's manual of the end product which integrates this module.

The end user manual shall include all required regulatory information/warning as show in this manual.

## 9.5 Industry Canada Statement

This device complies with Industry Canada's license-exempt RSSs. Operation is subject to the following two conditions:

- (1) This device may not cause interference; and
- (2) This device must accept any interference, including interference that may cause undesired operation of the device.

Le présent appareil est conforme aux CNR d'Industrie Canada applicables aux appareils radio exempts de licence. L'exploitation est autorisée aux deux conditions suivantes:

- (1) l'appareil ne doit pas produire de brouillage;
- (2) l'utilisateur de l'appareil doit accepter tout brouillage radioélectrique subi, même si le brouillage est susceptible d'en compromettre le fonctionnement.

### Radiation Exposure Statement

The product complies with the Canada portable RF exposure limit set forth for an uncontrolled environment and are safe for intended operation as described in this manual. The further RF exposure reduction can be achieved if the product can be kept as far as possible from the user body or set the device to lower output power if such function is available.

### Déclaration d'exposition aux radiations:

Le produit est conforme aux limites d'exposition pour les appareils portables RF pour les Etats-Unis et le Canada établies pour un environnement non contrôlé. Le produit est sûr pour un fonctionnement tel que décrit dans ce manuel. La réduction aux expositions RF peut être augmentée si l'appareil peut être conservé aussi loin que possible du corps de l'utilisateur ou que le dispositif est réglé sur la puissance de sortie la plus faible si une telle fonction est disponible.

This device is intended only for OEM integrators under the following conditions:

- (1) The transmitter module may not be co-located with any other transmitter or antenna.

As long as 1 condition above are met, further transmitter test will not be required. However, the OEM integrator is still responsible for testing their end-product for any additional compliance requirements required with this module installed.

### Cet appareil est conçu uniquement pour les intégrateurs OEM dans les conditions suivantes:

- (1) Le module émetteur peut ne pas être coïmplanté avec un autre émetteur ou antenne.

Tant que les 1 condition ci-dessus sont remplies, des essais supplémentaires sur l'émetteur ne seront pas nécessaires. Toutefois, l'intégrateur OEM est toujours responsable des essais sur son produit final pour toutes exigences de conformité supplémentaires requis pour ce module installé.

### IMPORTANT NOTE:

In the event that these conditions cannot be met (for example certain laptop configurations or co-location with another transmitter), then the Canada authorization is no longer considered valid and the IC ID cannot be used on the final product. In these circumstances, the OEM integrator will be responsible for re-evaluating the end product (including the transmitter) and obtaining a separate Canada authorization.

**NOTE IMPORTANTE:**

Dans le cas où ces conditions ne peuvent être satisfaites (par exemple pour certaines configurations d'ordinateur portable ou de certaines co-localisation avec un autre émetteur), l'autorisation du Canada n'est plus considéré comme valide et l'ID IC ne peut pas être utilisé sur le produit final. Dans ces circonstances, l'intégrateur OEM sera chargé de réévaluer le produit final (y compris l'émetteur) et l'obtention d'une autorisation distincte au Canada.

**End Product Labeling**

The final end product must be labeled in a visible area with the following: "Contains IC: 3147A-BL652".

**Plaque signalétique du produit final**

Le produit final doit être étiqueté dans un endroit visible avec l'inscription suivante: "Contient des IC: 3147A-BL652".

**Manual Information to the End User**

The OEM integrator has to be aware not to provide information to the end user regarding how to install or remove this RF module in the user's manual of the end product which integrates this module.

The end user manual shall include all required regulatory information/warning as show in this manual.

**Manuel d'information à l'utilisateur final**

L'intégrateur OEM doit être conscient de ne pas fournir des informations à l'utilisateur final quant à la façon d'installer ou de supprimer ce module RF dans le manuel de l'utilisateur du produit final qui intègre ce module. Le manuel de l'utilisateur final doit inclure toutes les informations réglementaires requises et avertissements comme indiqué dans ce manuel.

## 10 JAPAN (MIC) REGULATORY

The BL652 is approved for use in the Japanese market. The part numbers listed below hold WW type certification. Refer to **ARIB-STD-T66** for further guidance on OEM's responsibilities.

Model	Certificate Number	Antenna
BL652-SA	201-160415	Ceramic
BL652-SC	201-160416	IPEX MHF4

### 10.1 Antenna Information

The BL652 was tested with antennas listed below. The OEM can choose a different manufacturers antenna but must make sure it is of same type and that the gain is lesser than or equal to the antenna that is approved for use.

External Antenna Part Number	Laird Part Number	Mfg.	Type	Gain (dBi)	Connector Type	BL652 Part Number
FlexPIFA	001-0022	LSR	PCB Dipole	2.0	IPEX-4	BL652-SC
mFlexPIFA	001-0030	Laird	PCB Dipole	2.0	IPEX U.FL	BL652-SC



External Antenna Part Number	Laird Part Number	Mfg.	Type	Gain (dBi)	Connector Type	BL652 Part Number
FlexNotch	001-0023	LSR	PCB Dipole	2.0	IPEX-4	BL652-SC
EDA-8709-2G4C1-B27-CY		Mag.Layers	Dipole	2.0	IPEX-4	BL652-SC
RFDPA870910EMAB302	0600-00057	Walsin	Dipole	2.0	IPEX-4	BL652-SC

## 11 CE REGULATORY

The BL652-SA/BL652-SC have been tested for compliance with relevant standards for the EU market. The BL652-SC module was tested with a 2.21 dBi antenna. The OEM can operate the BL652-SC module with any other type of antenna but must ensure that the gain does not exceed 2.21 dBi to maintain the Laird approval.

The OEM should consult with a qualified test house before entering their device into an EU member country to make sure all regulatory requirements have been met for their complete device.

Reference the Declaration of Conformities listed below for a full list of the standards that the modules were tested to. Test reports are available upon request.

### 11.1 Antenna Information

The antennas listed below were tested for use with the BL652. For CE mark countries, the OEM is free to use any manufacturer’s antenna and type of antenna as long as the gain is less than or equal to the highest gain approved for use (2.21dBi) Contact a Laird representative for more information regarding adding antennas.

External Antenna Part Number	Laird Part Number	Mfg.	Type	Gain (dBi)	Connector Type	BL652 Part number
FlexPIFA	001-0022	LSR	PCB Dipole	2.0	IPEX-4	BL652-SC
mFlexPIFA	001-0030	Laird	PCB Dipole	2.0	IPEX U.FL	BL652-SC
FlexNotch	001-0023	LSR	PCB Dipole	2.0	IPEX-4	BL652-SC
EDA-8709-2G4C1-B27-CY		Mag.Layers	Dipole	2.0	IPEX-4	BL652-SC
RFDPA870910EMAB302	0600-00057	Walsin	Dipole	2.0	IPEX-4	BL652-SC

**Note:** The BL652 module internal BLE chipset IC pins are rated 4 kV (ESD HBM). ESD can find its way through the external JTAG connector (if used on the customer’s design), if discharge is applied directly. Customer should ensure adequate protection against ESD on their end product design (using the BL652 module) to meet relevant ESD standard (for CE, this is EN301-489).

## 11.2 EU Declarations of Conformity

<b>Manufacturer</b>	Laird
<b>Products</b>	BL652-SA, BL652-SC
<b>Product Description</b>	Bluetooth v5.0 + NFC
<b>EU Directives</b>	2014/53/EU – Radio Equipment Directive (RED)

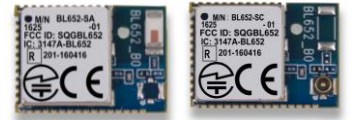

**Reference standards used for presumption of conformity:**

Article Number	Requirement	Reference standard(s)
3.1a	Low voltage equipment safety	EN 60950-1:2006 +A11:2009 +A1:2010 +A12:2011 +A2:2013
	RF Exposure	EN 62311:2008
3.1b	Protection requirements – Electromagnetic compatibility	EN 301 489-1 v2.2.0 (2017-03)
		EN 301 489-17 v3.2.0 (2017-03)
3.2	Means of the efficient use of the radio frequency spectrum (ERM)	EN 300 328 v2.1.1 (2016-11)      Wide-band transmission systems
		EN 300 330 v2.1.1 (2017-02)      Short Range Devices (SRD)

**Declaration:**

We, Laird, declare under our sole responsibility that the essential radio test suites have been carried out and that the above product to which this declaration relates is in conformity with all the applicable essential requirements of Article 3 of the EU Radio Equipment Directive 2014/53/EU, when used for its intended purpose.

Place of Issue:	Laird W66N220 Commerce Court, Cedarburg, WI 53012 USA tel: +1-262-375-4400 fax: +1-262-364-2649
Date of Issue:	May 2017
Name of Authorized Person:	Thomas T Smith, Director of EMC Compliance
Signature of Authorized Person:	

## 12 ORDERING INFORMATION

<b>BL652-SA-0x</b>	Intelligent BTv5.0 Module featuring <i>smart</i> BASIC (internal antenna)
<b>BL652-SC-0x</b>	Intelligent BTv5.0 Module featuring <i>smart</i> BASIC (IPEX MHF4 connector)
<b>DVK-BL652-SA / SC-0x</b>	Development Kit for each BL652 series module above

## 13 BLUETOOTH SIG QUALIFICATION

### 13.1 Overview

The BL652 module is listed on the Bluetooth SIG website as a qualified End Product.

Design Name	Owner	Declaration ID	QD ID	Link to listing on the SIG website
BL652	Laird Technologies	D031950	87158	<a href="https://www.bluetooth.org/tpg/QLI_viewQDL.cfm?qid=31950">https://www.bluetooth.org/tpg/QLI_viewQDL.cfm?qid=31950</a>
BL652*	Laird Technologies	D036437	98795	<a href="https://www.bluetooth.org/tpg/QLI_viewQDL.cfm?qid=36437">https://www.bluetooth.org/tpg/QLI_viewQDL.cfm?qid=36437</a>

(\* Modules with firmware v27.7.3.0)

It is a mandatory requirement of the Bluetooth Special Interest Group (SIG) that every product implementing Bluetooth technology has a Declaration ID. Every Bluetooth design is required to go through the qualification process, even when referencing a Bluetooth Design that already has its own Declaration ID. The Qualification Process requires each company to registered as a member of the Bluetooth SIG – [www.bluetooth.org](http://www.bluetooth.org)

The following link provides a link to the Bluetooth Registration page: <https://www.bluetooth.org/login/register/>  
For each Bluetooth Design, it is necessary to purchase a Declaration ID. This can be done before starting the new qualification, either through invoicing or credit card payment. The fees for the Declaration ID will depend on your membership status, please refer to the following webpage:

<https://www.bluetooth.org/en-us/test-qualification/qualification-overview/fees>

For a detailed procedure of how to obtain a new Declaration ID for your design, please refer to the following SIG document:

[https://www.bluetooth.org/DocMan/handlers/DownloadDoc.ashx?doc\\_id=283698&vld=317486](https://www.bluetooth.org/DocMan/handlers/DownloadDoc.ashx?doc_id=283698&vld=317486)

### 13.2 Qualification Steps When Referencing a Laird End Product Design

To start a listing, go to: [https://www.bluetooth.org/tpg/QLI\\_SDoc.cfm](https://www.bluetooth.org/tpg/QLI_SDoc.cfm)

In step 1, select the option, **Reference a Qualified Design** and enter 87158 in the End Product table entry. You can then select your pre-paid Declaration ID from the drop down menu or go to the Purchase Declaration ID page, (please note that unless the Declaration ID is pre-paid or purchased with a credit card, it will not be possible to proceed until the SIG invoice is paid.

Once all the relevant sections of step 1 are finished, complete steps 2, 3, and 4 as described in the help document. Your new Design will be listed on the SIG website and you can print your Certificate and DoC.

For further information, please refer to the following training material:

<https://www.bluetooth.org/en-us/test-qualification/qualification-overview/listing-process-updates>

**Note:** If using the BL652 with Laird Firmware and *smartBASIC* script, you can skip “Controller Subsystem”, “Host Subsystem”, and “Profile Subsystem”.

### 13.3 Qualification Steps When Deviating from a Laird End Product Design

If you wish to deviate from the standard End Product design listed under D031950, the qualification process follows the Traditional Project route, creating a new design. When creating a new design, it is necessary to complete the full qualification listing process and also maintain a compliance folder for the new design.

The BL652 design under D031950 incorporates the following components:

Listing reference	Design Name	Core Spec Version
<a href="#">31118</a>	S132 link layer 3.0.0	5.0
<a href="#">30169</a>	S132 nRF52 v3.0.0 Host Layer	5.0

In the future, Nordic may list updated versions of these components and it is possible to use them in your new design. Please check with Nordic to make sure these software components are compatible with the nRF52 hardware ([D029601](#)).

If your design is based on un-modified BL652 hardware it is possible use the following process;

1. Reference the existing RF-PHY test report from the BL652 listing.
2. Combine the relevant Nordic Link Layer (LL) – check QDID with Nordic.
3. Combine in a Host Component (covering L2CAP, GAP, ATT, GATT, SM) - check QDID with Nordic.
4. Test any standard SIG profiles that are supported in the design (customs profiles are exempt).

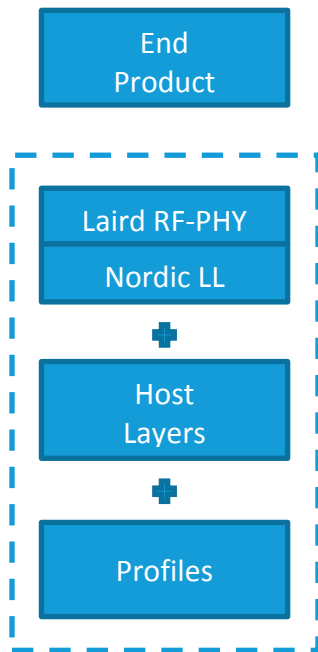

**Figure 21: Scope of the qualification for an End Product Design**

The first step is to generate a project on the TPG (Test Plan Generator) system. This determines which test cases apply to demonstrate compliance with the Bluetooth Test Specifications. If you are combining pre-tested and qualified components in your design and they are within their three-year listing period, you are not required to re-test those layers covered by these components.

If the design incorporates any standard SIG LE profiles (such as Heart Rate Profile), it is necessary to test these profiles using PTS or other tools where permitted; the results are added to the compliance folder.

You are required to upload your test declaration and test reports (where applicable) and then complete the final listing steps on the SIG website. Remember to purchase your Declaration ID before you start the qualification process, as it's impossible to complete the listing without it.

## 14 ADDITIONAL ASSISTANCE

Please contact your local sales representative or our support team for further assistance:

Laird Technologies Connectivity Products Business Unit

Support Centre: <http://ews-support.lairdtech.com>

Email: [wireless.support@lairdtech.com](mailto:wireless.support@lairdtech.com)

Phone: Americas: +1-800-492-2320

Europe: +44-1628-858-940

Hong Kong: +852 2923 0610

Web: <http://www.lairdtech.com/bluetooth>

© Copyright 2017 Laird. All Rights Reserved. Patent pending. Any information furnished by Laird and its agents is believed to be accurate and reliable. All specifications are subject to change without notice. Responsibility for the use and application of Laird materials or products rests with the end user since Laird and its agents cannot be aware of all potential uses. Laird makes no warranties as to non-infringement nor as to the fitness, merchantability, or sustainability of any Laird materials or products for any specific or general uses. Laird, Laird Technologies, Inc., or any of its affiliates or agents shall not be liable for incidental or consequential damages of any kind. All Laird products are sold pursuant to the Laird Terms and Conditions of Sale in effect from time to time, a copy of which will be furnished upon request. When used as a tradename herein, Laird means Laird PLC or one or more subsidiaries of Laird PLC. Laird™, Laird Technologies™, corresponding logos, and other marks are trademarks or registered trademarks of Laird. Other marks may be the property of third parties. Nothing herein provides a license under any Laird or any third party intellectual property right.