

Max. 170 m³/h

DC axial fans

□ 119 x 25 mm



- **Material:** Housing: GRP¹⁾ (PBT)
Impeller: GRP¹⁾ (PA)
 - **Direction of air flow:** Exhaust over struts
 - **Direction of rotation:** Counterclockwise, looking towards rotor
 - **Connection:** Via single wires AWG 24, TR 64
 - **Highlights:** Ball bearings and sleeve bearings available
 - **Weight:** 175 g
- **Possible special versions:** (See chapter DC fans - specials)
 - Speed signal
 - Go / NoGo alarm
 - Alarm with speed limit
 - External temperature sensor
 - Internal temperature sensor
 - PWM control input
 - Analog control input
 - Moisture protection

1) Fiberglass-reinforced plastic

Series 4400 F

Nominal data

Type	Air flow		Nominal voltage	Voltage range	Sound pressure level	Sound power level	Sinter sleeve bearings Ball bearings	Power consumption	Nominal speed	Temperature range	Service life L ₁₀ (40 °C) ebm-papst standard	Service life L ₁₀ (T _{max}) ebm-papst standard	Life expectancy L ₁₀ (IPC (40 °C) see page 17	Curve
	m ³ /h	cfm												
4412 FGL	94	55	12	7...14	26	3.9	□	1.3	1 600	-20...+75	80 000 / 32 500	135 000	①	
4412 FGML	114	67	12	7...12.6	32	4.3	□	2.0	1 950	-20...+75	75 000 / 30 000	127 500	②	
4412 FML	114	67	12	7...12.6	32	4.3	■	2.0	1 950	-20...+75	75 000 / 30 000	127 500	②	
4412 FGM	140	82	12	7...12.6	38	4.8	□	3.2	2 400	-20...+75	70 000 / 27 500	117 500	③	
4412 FM	140	82	12	7...12.6	38	4.8	■	3.2	2 400	-20...+75	70 000 / 27 500	117 500	③	
4412 FG	170	100	12	8...12.6	43	5.3	□	5.3	2 900	-20...+60	60 000 / 37 500	102 500	④	
4412 F	170	100	12	8...12.6	43	5.3	■	5.3	2 900	-20...+60	60 000 / 37 500	102 500	④	
4414 FL	94	55	24	18...28	26	3.9	■	1.2	1 600	-20...+75	80 000 / 32 500	135 000	①	
4414 FM	140	82	24	12...28	38	4.8	■	3.1	2 400	-20...+75	70 000 / 27 500	117 500	③	
4414 FG	170	100	24	12...28	43	5.3	□	5.0	2 900	-20...+60	60 000 / 37 500	102 500	④	
4414 F	170	100	24	12...28	43	5.3	■	5.0	2 900	-20...+60	60 000 / 37 500	102 500	④	
4418 FG	170	100	48	28...53	43	5.3	□	5.4	2 900	-20...+60	60 000 / 37 500	102 500	④	
4418 F	170	100	48	28...53	43	5.3	■	5.4	2 900	-20...+60	60 000 / 37 500	102 500	④	

Subject to change

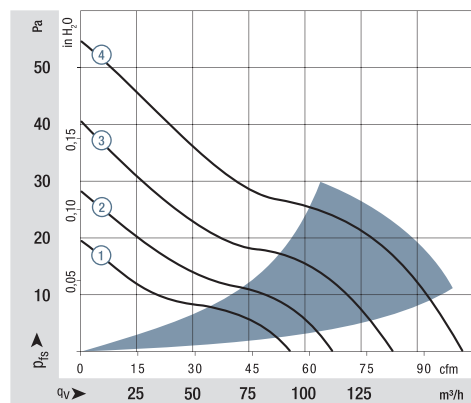

Air performance measured according to: ISO 5801.
Installation category A, without contact protection.
Noise: Total sound power level L_{WA} ISO 103002 measured on a hemisphere with a radius of 2 m.
Sound pressure level L_{pA} measured at 1 m distance from fan axis.
The values given are applicable only under the specified measuring conditions and may differ depending on the installation conditions.
In the event of deviation from the standard configuration, the parameters must be checked after installation!
For detailed information see <http://www.ebmpapst.com/general conditions>

Available as an option:
Fan housing with molded-in spacers

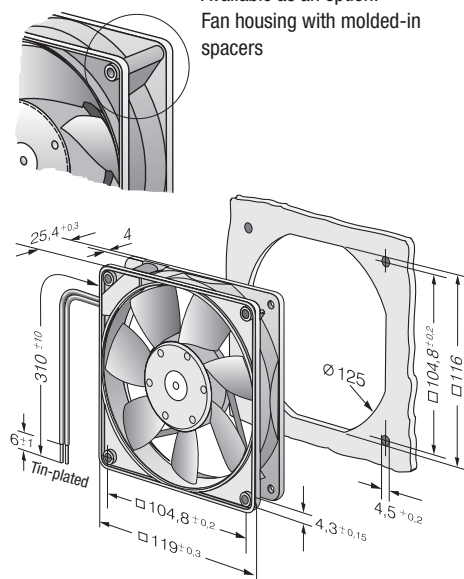

Speed signal /12

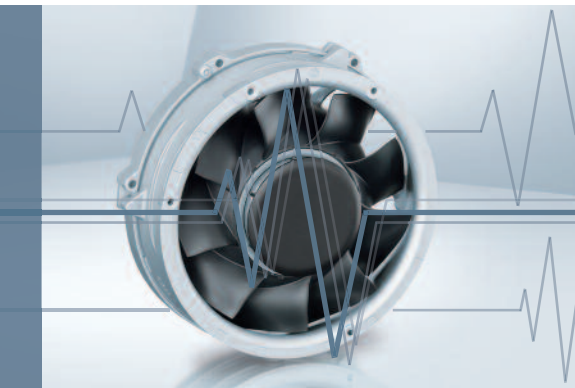

- Speed-proportional, square-wave signal for external monitoring of the fan motor speed
- 2, 3, or 6 pulses per revolution
- TTL-compatible
- Integrated pull-up resistor
- Connection via separate cable
- The sensor signal also serves as a major comparison variable for setting and maintaining the setpoint speed for interactive or controlled cooling with one or more interconnected fans.

Electrical hookup

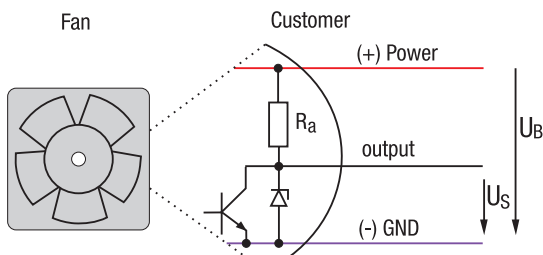

All voltages measured to ground.

Signal output voltage

Standard signal for all models (exceptions see below)

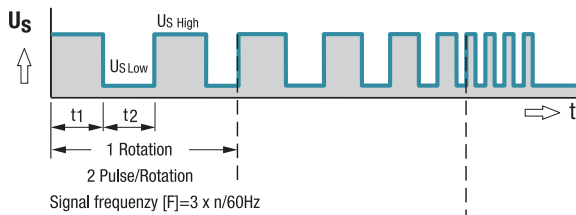

For multi options control input and 4100 NH7 and NH8

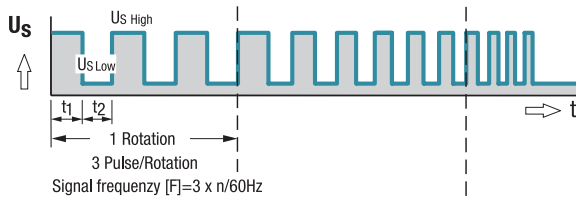

All TD Fans e.g. 6300 TD

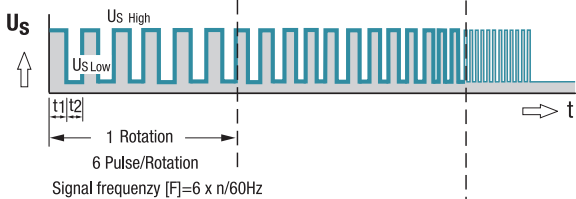

Fan speed

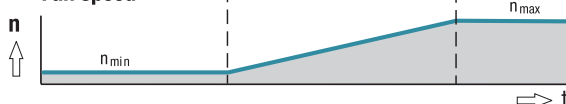

Signal data	Speed signal $U_{S\text{Low}}$	Condition: I_{sink}	Speed signal $U_{S\text{High}}$	Condition: I_{source}	Admissible sink current $I_{\text{sink max.}}$	Fan description Basic type
Type	VDC	mA	VDC	mA	mA	Page
614 N/12 GM	≤ 0.4	1	2.5–5.5	1	1	39
618 N/12 N	≤ 0.4	1	2.5–5.5	1	1	39
8412 N/12 H	≤ 0.4	1	2.5–5.5	1	1	44
4412 F/12 GM	≤ 0.4	1	2.5–5.5	1	1	53
4418 F/12	≤ 0.4	1	2.5–5.5	1	1	53
4312 /12 M	≤ 0.4	1	2.5–5.5	1	1	56
4314 /12	≤ 0.4	1	2.5–5.5	1	1	56
4182 N/12 X	≤ 0.4	1	2.5–5.5	1	1	60

Subject to change

Note:

With these fan options, deviations in regard to temperature range, voltage range and power consumption are possible compared with standard fan data.

Available on request:

- Electrically isolated speed signal circuit
- Varying voltage potentials for power and logic circuit

Signal data		Speed signal U _S Low	Condition: I _{sink}	Speed signal U _S High	Condition: I _{source}	Admissible sink current I _{sink} max.	Fan description Basic type
Type	VDC	mA	VDC	mA	mA	Page	
7214 N/12	≤0.4	2	2.5–5.5	1	≤20	70	
6424/12 H	≤0.4	2	2.5–5.5	1	≤20	71	
DV 6424/12	≤0.4	2	4.5–5.25	2	≤12	73	
DV 6448/12	≤0.4	2	4.5–5.25	2	≤12	73	
RG 125-19/12 N/12	≤0.4	1	2.5–5.5	1	≤1	103	
RG 160-28/12 N/12	≤0.4	2	2.5–5.5	1	≤5	104	
RG 160-28/18 N/12	≤0.4	2	2.5–5.5	1	≤20	104	
RER 125-19/12 N/12	≤0.4	1	2.5–5.5	1	≤1	116	
RER 160-28/12 N/12	≤0.4	2	2.5–5.5	1	≤5	118	
RER 160-28/18 N/12	≤0.4	2	2.5–5.5	1	≤20	118	

Subject to change

Note:

Fans that come with these fan specials could have variations with respect to the temperature range, voltage range, and power consumption compared to standard fans without specials.