

COLOR TABLE	
BLANK	BLACK
0	WHITE
1	BROWN
2	RED
3	ORANGE
4	YELLOW
5	GREEN
6	BLUE
7	PURPLE
8	GREY
9	DARK RED
C	CREAM

NOTES:

1. MATERIAL: HIGH TEMP. THERMOPLASTIC, UL 94V-0, BLACK.
2. THIS HSG IS USED WITH FCI RECEPTACLE TERMINAL 10132447.
3. THIS RECEPTACLE MATES WITH FCI PLUG 10132446, 10132449 & 10132450.
4. PRODUCT SPECIFICATION: GS-12-1291.
5. PACKAGE SPECIFICATION: GS-14-2419.
6. PART NUMBER SCHEME:
10132445- XX XLF

POS. CODE:
 02: 2 POS.
 04: 4 POS.
 5
 24: 24 POS.
 INSULATION COLOR, SEE COLOR TABLE

DIMENSIONAL & PART NO. TABLE:

PART NO.	POS	A	B
10132445-02LF	2	3.85	
10132445-04LF	4	6.85	
10132445-06LF	6	6.0	9.85
10132445-08LF	8	9.0	12.85
10132445-10LF	10	12.0	15.85
10132445-12LF	12	15.0	18.85
10132445-14LF	14	18.0	21.85
10132445-16LF	16	21.0	24.85
10132445-18LF	18	24.0	27.85
10132445-20LF	20	27.0	30.85
10132445-22LF	22	30.0	33.85
10132445-24LF	24	33.0	36.85

mat'l. code		surface ISO 1302 ✓		tolerance ISO 406 ISO 1101		projection		product family	
A		TAI 2015-02-25		tolerances unless otherwise specified		MINITEK PWR3.0		MINITEK PWR3.0	
B		ELX-N-28240 TONY 2017-10-24		angles linear		mm		title	
				0°±3'		scale 1:1		MINITEK PWR3.0 REC. HSG HIGH CURRENT	
				dr KENNY TAI 2015-02-03		Amphenol FCI		dwg no 10132445 sheet 1 of 3 size A3	
				engr KENNY TAI 2015-02-03				type Product Customer Drawing	
				chr KENNY TAI 2015-02-03					
				appd PM ZHENG 2015-02-25					
sheet index		revision sheet		B B B					
		1 2 3							

2 POS.

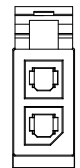

10 POS.

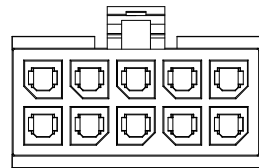

18 POS.

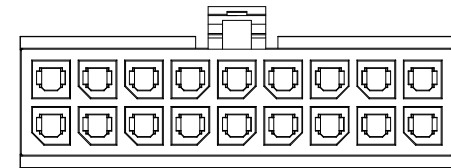

4 POS.

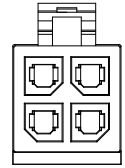

12 POS.

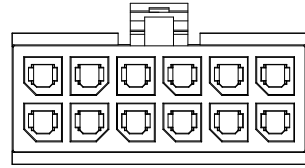

20 POS.

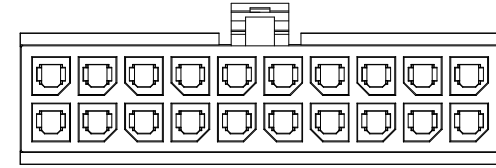

6 POS.

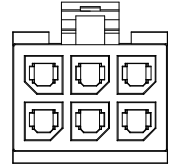

14 POS.

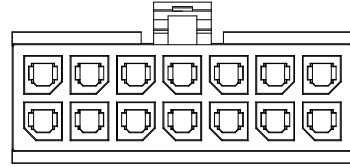

22 POS.

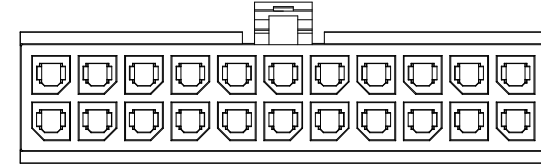

8 POS.

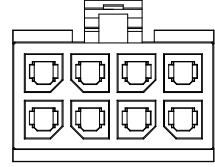

16 POS.

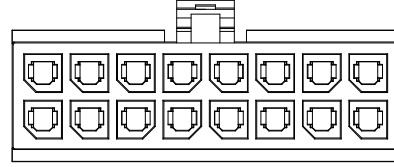

24 POS.

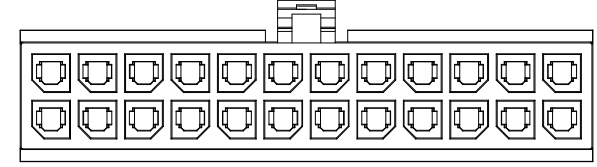

mat'l. code		surface		tolerance		projection		product family	
		ISO 1302 ✓		ISO 406 ISO 1101				MINITEK PWR3.0	
ltr		ecn no		dr		date		title	
								MINITEK PWR3.0 REC. HSG HIGH CURRENT	
				angles		linear		dwg no	
				0°±3'		.0±.50 .00±.30 .000±.20		sheet 2 of 3	
				dr		KENNY TAI 2015-02-03		size	
				engr		KENNY TAI 2015-02-03		A3	
				chr		KENNY TAI 2015-02-03		10132445	
				appd		PM ZHENG 2015-02-25		type	
								Product Customer Drawing	
sheet		revision		B		B			
index		sheet		1		2		3	

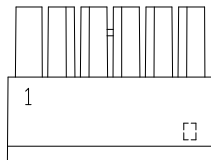

CONNECTOR

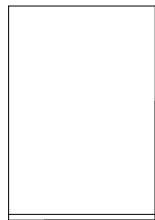

BAG

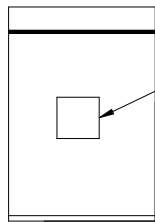

LABEL

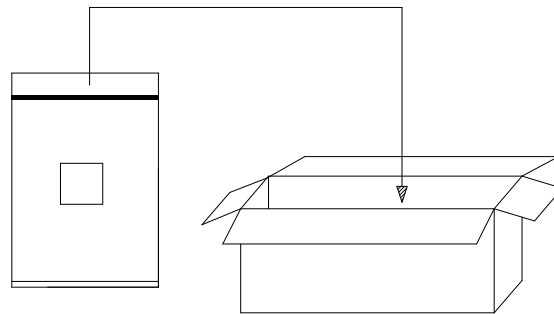

CARTON:450*370*250mm

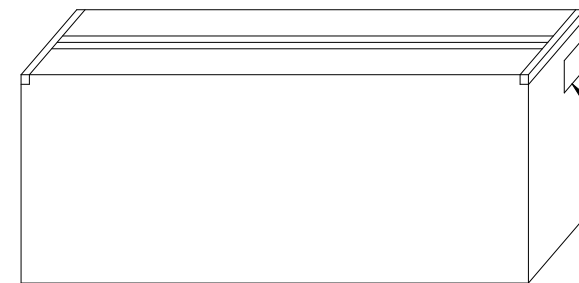

LABEL

PACKING MATERIAL		
PART NAME	PIN	DIM.(mm)
PE BAG	2	0.08*160*240
	4	0.08*180*260
	6~14	0.08*210*270
	16~22	0.08*240*310
	24	0.08*210*270

PACKING CAPACITY			
PIN	PCS/BAG	BAG/BC	PCS/BC
2~6	1,000	16	16000
8~10	1,000	12	12000
12~22	500	12	6000
24	200	12	2400

mat'l. code		surface	tolerance	projection	product family
		ISO 1302 ✓	ISO 406 ISO 1101		MINITEK PWR3.0
ltr	ecn no	dr	date	tolerances unless otherwise specified	title
				linear	MINITEK PWR3.0 REC. HSG HIGH CURRENT
				angles	mm
				0°±3'	scale 1:1
				dr	KENNY TAI 2015-02-03
				engr	KENNY TAI 2015-02-03
				chr	KENNY TAI 2015-02-03
				appd	PM ZHENG 2015-02-25
sheet index	revision sheet	B 1	B 2	B 3	dwg no 10132445 sheet 3 of 3 size A3
					type Product Customer Drawing