

ENERGIZER EN22

9V

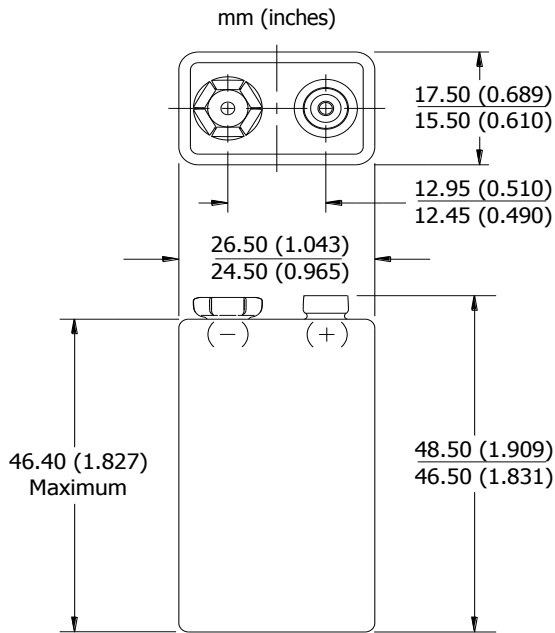

Industry Standard Dimensions



Specifications

Classification:	Alkaline
Chemical System:	Zinc-Manganese Dioxide (Zn/MnO ₂) No added mercury or cadmium
Designation:	IEC-6LF22 ANSI-1604A
Nominal Voltage:	9.0 volts
Operating Temp:	-18°C to 55°C
Typical Weight:	45.0 grams (1.58 oz.)
Typical Volume:	21.1 cubic centimeters
Shelf Life:	5 years at 21°C
Terminal:	Miniature Snap

Continuous Discharge

to 4.8 volts at 21°C

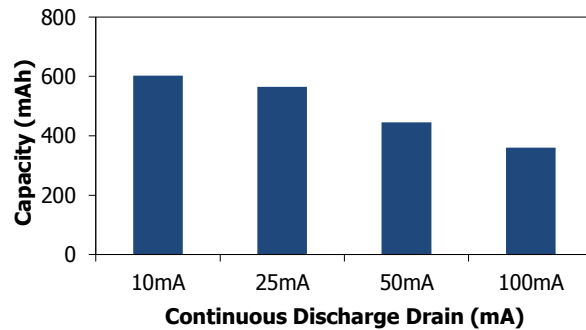

Industry Standard Tests (21°C)

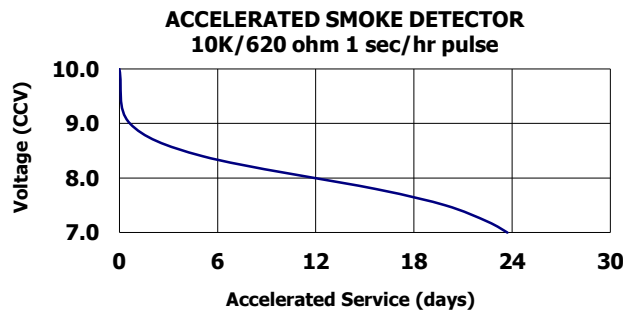
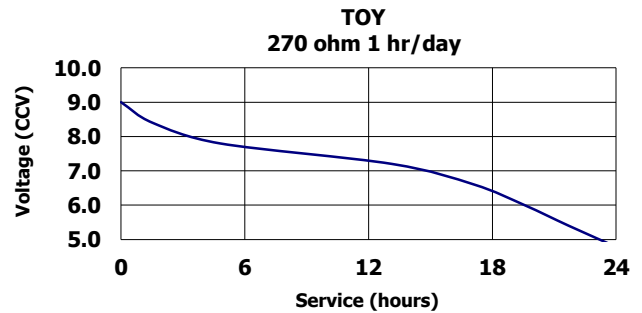
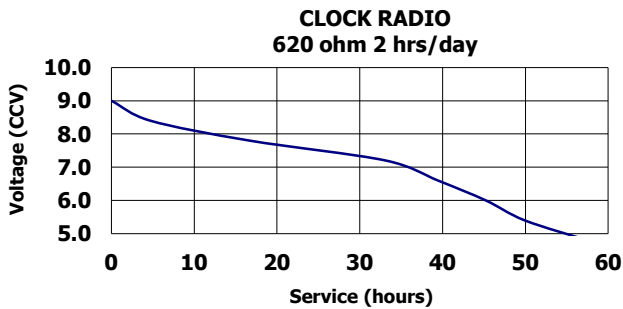

Important Notice

This datasheet contains typical information specific to products manufactured at the time of its publication.
©Energizer Brands, LLC - Contents herein do not constitute a warranty.