

DETAIL A

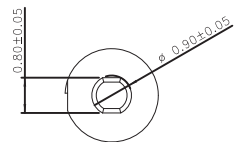

DETAIL B

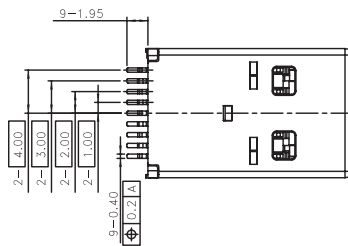
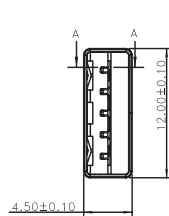
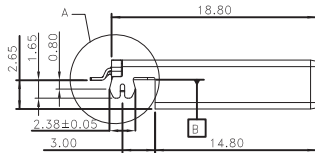
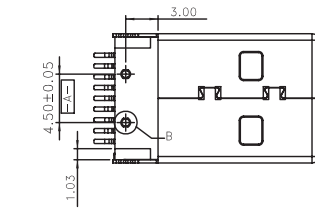
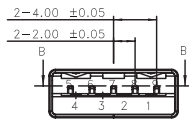
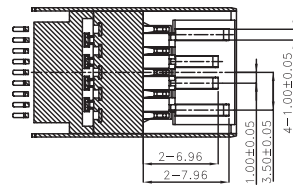

B - B

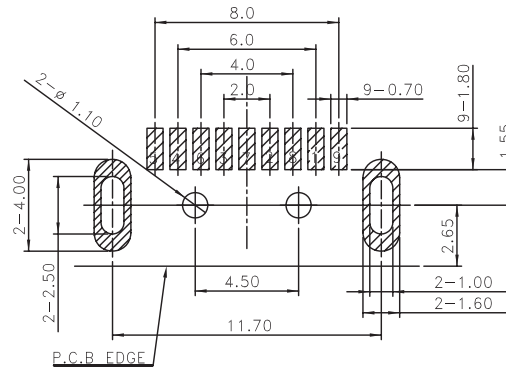

PCB LAYOUT - COMPONENT VIEW

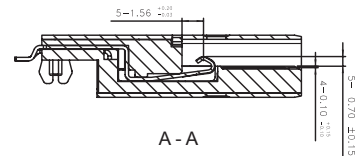

A - A

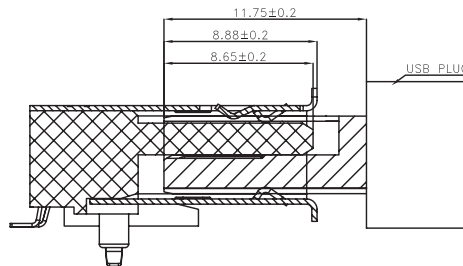

TECHNICAL CHARACTERISTICS

MATERIAL

INSULATOR: LCP  
 FLAMMABILITY RATING: UL94-V0  
 COLOR: BLUE  
 CONTACT MATERIAL: PHOSPHORE BRONZE  
 CONTACT TYPE: STAMPED  
 CONTACT PLATING: UNDERPLATE 1.27 to 2.54 µm Ni  
 CONTACT AREA 0.76 µm Gold  
 SOLDER TAIL AREA 2.54 to 5.08 µm Matt Tin  
 SHIELDING: STEEL BRIGHT TIN PLATED  
 QUALITY CLASS: 5000 MATING CYCLES

ENVIRONMENTAL

OPERATING TEMPERATURE: -20°C up to +85°C  
 COMPLIANCE: LEAD FREE & RoHS

ELECTRICAL

CURRENT RATING:  
 - PIN 1 & PIN 4 (Vbus & corresponding ground PIN) 1.8A MAX  
 - OTHER PINS 0.25 A MAX  
 WORKING VOLTAGE: 30 VAC  
 DIELECTRIC WITHSTANDING VOLTAGE: 100 VAC/MIN  
 INSULATION RESISTANCE: > 100 MΩ  
 CONTACT RESISTANCE:  
 - PIN 1 & PIN 4: 30mΩ MAX  
 - OTHER PINS: 50mΩ MAX

STANDARD

CERTIFIED: E323964

MECHANICAL

INSERTION FORCE: 35.0N MAX  
 EXTRACTION FORCE: 10.0N MIN

SOLDERING

JEDEC LEAD FREE REFLOW SOLDERING

PACKAGING

TRAY

\* NOTE: THE RECOMMENDED PCB LAYOUT IS FOR AN OPTIMIZED RETENTION FORCE OF CONNECTOR ON PCB BUT IT IMPLIES INSERTION FORCE THAT A LOT OF PICK AND PLACE MACHINES ARE NOT ABLE TO HANDLE. THEREFORE IT MIGHT BE NECESSARY TO DRILL BIGGER HOLES FOR THE CLIPS. PLEASE CHECK THIS CAREFULLY.

RoHS Compliant			
I	02-MAR-16	TPK	AK
H	10-JAN-15	TOLERANCES	QP
REV	DATE	FILE	BY

PROJECTION:	
APPROVAL: NPr	

GENERAL TOLERANCE	.X = $\pm$ 0.2
	.XX = $\pm$ 0.15
UNIT: MM	
SCALE:	
SHEET: 1/4	
DRAW: AS	

DESCRIPTION: WR COM - USB 3.0 SMT PLUG WITH CLIP TYPE A	SIZE
WERI PART NO: 692 112 030 100	<b>A4</b>

1

2

3

4

5

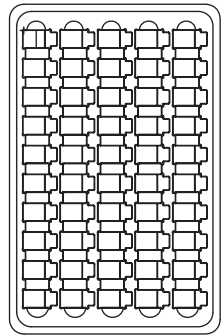

50PCS / TRAY

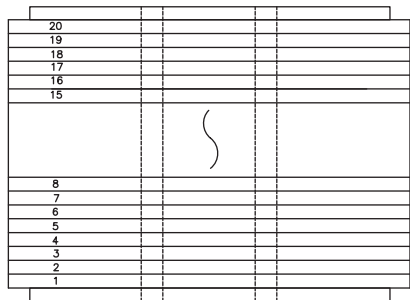

20 TRAY

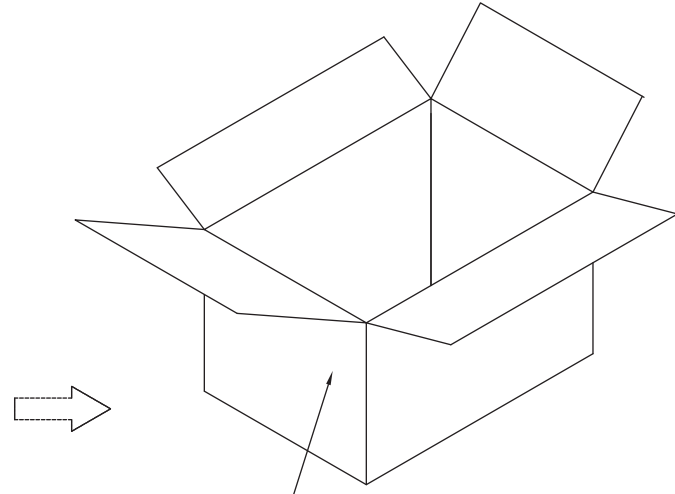
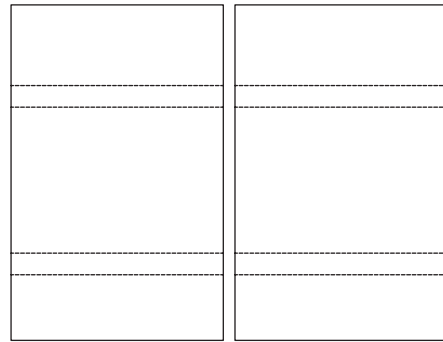
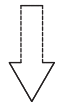



CARTON SPEC.  
320\*245\*220

NOTES  
MATERIALS: PVC

All Material in According With The Rohs Environment  
Related Substances List Controlled.

50 pcs/tray  
40 trays/carton  
2000 pcs/carton

RoHS Compliant				PROJECTION: 	GENERAL TOLERANCE .X = +/- 0.2 .XX = +/- 0.15	
G						
F						
E						
D						
C			APPROVAL: NPr	UNIT: MM	DESCRIPTION: WR-COM - USB 3.0 SMT PLUG WITH CLIP TYPE A	SIZE <b>A4</b>
B				SCALE:		
A				SHEET: 2/4		
REV	DATE	FILE	BY	DRAW: AS	WERI PART NO: 692 112 030 100	

A

B

C

D

1

2

3

4

5

## Stencil information for Through Hole Reflow soldering

## PCB cross section

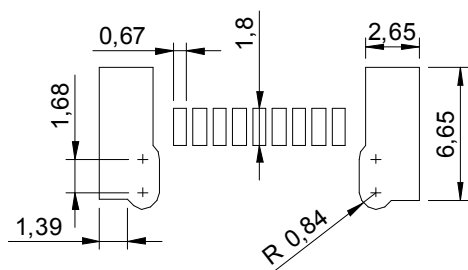

STENCIL LAYOUT \* - COMPONENT VIEW

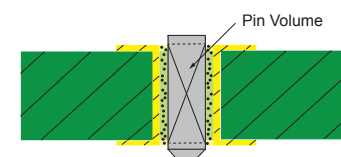
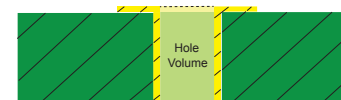

 Free volume for solder paste

## Theoretical Formula for Through Hole pins

Volume of the stencil aperture = (Hole volume - Pin volume) x 2

or

Volume of solder paste = (Hole volume - Pin volume) x 2



Stencil

Stencil Thickness: 150 µm

PCB

PCB thickness: 1.6mm

\* NOTE: SEE PCB LAYOUT PAGE 1/3 FOR MISSING DIMENSIONS

RoHS Compliant				PROJECTION: 	GENERAL TOLERANCE .X = $\pm 0.2$ .XX = $\pm 0.15$		DESCRIPTION: WR-COM - USB 3.0 SMT PLUG WITH CLIP TYPE A	SIZE <b>A4</b>
G								
F								
E								
D								
C				APPROVAL: NPr	UNIT: MM	WERI PART NO: 692 112 030 100		
B				SCALE:				
A				SHEET: 3/4				
REV	DATE	FILE	BY	DRAW: AS				

1

2

3

4

5

## Cautions and Warnings:

This electronic component is designed and developed with the intention for use in general electronics equipments.

Before incorporating the components into any equipments in the field such as aerospace, aviation, nuclear control, submarine, transportation, (automotive control, train control, ship control), transportation signal, disaster prevention, medical, public information network etc. where higher safety and reliability are especially required or if there is possibility of direct damage or injury to human body, Würth Elektronik must be asked for a written approval.



In addition, even electronic component in general electronic equipments, when used in electrical circuits that require high safety, reliability functions or performance, the sufficient reliability evaluation-check for the safety must be performed before by the user before usage.

A

B

C

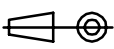
RoHS Compliant

G				PROJECTION: 	GENERAL TOLERANCE .X = +/- 0.2 .XX = +/- 0.15		
F							
E							
D							
C				APPROVAL: JC	UNIT: MM	DESCRIPTION: DISCLAIMER	SIZE <b>A4</b>
B					SCALE:		
A	10-SEP-14	PDF	QL		SHEET: 4/4	WERI PART NO: DISCLAIMER	
REV	DATE	FILE	BY		DRAW: QL		

D