

pushPIN™ Heat Sink Attachments

ATTACHMENT OPTIONS FOR ATS PUSHPIN™ HEATSINKS



Push Pins



Push Pin Spring Kits



Hardware Kits

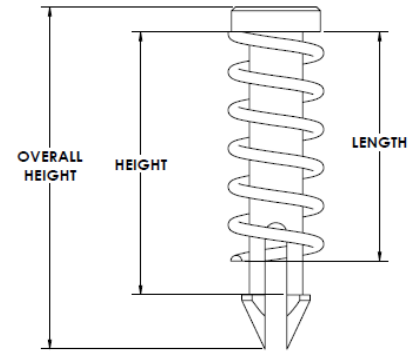

Individual Push Pins

Part #	Description	Dimensions			
		HEIGHT (mm)	OVERALL HEIGHT (mm)	WEIGHT (gr)	BOARD HOLE SIZE (mm)
ATS-PP-01	Brass Push Pin, 9 mm	9.0	11.77	0.86	3.175
ATS-PP-02	Brass Push Pin, 10 mm	10.0	12.77	0.91	3.175
ATS-PP-03	Brass Push Pin, 11 mm	11.0	13.77	0.97	3.175
ATS-PP-04	Brass Push Pin, 12 mm	12.0	14.77	1.02	3.175
ATS-PP-05	Brass Push Pin, 13 mm	13.0	15.57	1.07	3.175
ATS-PP-06	Brass Push Pin, 14 mm	14.0	15.27	1.12	3.175
ATS-PP-08	Brass Push Pin, 18 mm	18.8	21.57	1.37	3.175
ATS-PP-09	Brass Push Pin, 20 mm	20.3	23.07	1.45	3.175

Individual Push Pin Spring Kits

PART #	DESCRIPTION	LENGTH (mm)	HEIGHT (mm)	OVERALL HEIGHT (mm)	FORCE (lb/mm)	BOARD HOLE SIZE (mm)	QUANTITY PER HEAT SINK	MATERIAL
ATS-HK127-R0	PLASTIC PIN AND SPRING ASMBLY	7.3	10.3	13.3	.47	3.0	1	PLASTIC
ATS-HK91-R0	BRASS PIN AND SPRING ASMBLY	12.7	13.70	16.47	.40	3.0	1	BRASS

Individual Hardware Kits

PART #	DESCRIPTION	LENGTH (mm)	HEIGHT (mm)	OVERALL HEIGHT (mm)	FORCE (lb/mm)	BOARD HOLE SIZE (mm)	QUANTITY PER HEAT SINK	MATERIAL
ATS-HK76-R0	PEM, SPRING AND SCREWS, QTY 2/EA	8.0	11.5	14.0	1.0	3.0	1	SS

The tolerance for the board hole size is ±0.05mm. Plated thru holes are recommended.

Individual Springs

Part #	Description	OD (mm)	WD (mm)	ID (mm)	FL (mm)	SL (mm)	Force (lb/mm)	Material	Finish
ATS-PPS-01	MUSIC WIRE COIL SPRING, QTY 1	4.6	0.5	3.7	11.2	3.1	0.3	Music Wire	Zinc Plate
ATS-PPS-02	STAINLESS STEEL COIL SPRING, QTY 1	4.6	0.5	3.7	11.2	3.1	0.3	SS Type 302	Passivate per ASTM A967
ATS-PPS-03	MUSIC WIRE COIL SPRING, QTY 1	4.6	0.6	3.5	9.5	3.7	0.8	Music Wire	Zinc Plate
ATS-PPS-04	MUSIC WIRE COIL SPRING, QTY 1	4.8	0.5	3.7	11.1	3.5	0.4	Music Wire	Zinc Plate
ATS-PPS-05	STAINLESS STEEL COIL SPRING, QTY 1	4.75	0.5	3.7	14.3	4.3	0.3	SS Type 302	Passivate per ASTM A967
ATS-PPS-06	MUSIC WIRE COIL SPRING, QTY 1	4.6	0.6	3.5	6.4	2.8	1.2	Music Wire	Zinc Plate
ATS-PPS-07	MUSIC WIRE COIL SPRING, QTY 1	4.6	0.6	3.4	12.7	5.6	0.8	Music Wire	Zinc Plate
ATS-PPS-08	STAINLESS STEEL COIL SPRING, QTY 1	5.5	0.7	4.1	8.0	3.8	1.4	SS Type 302	Passivate per ASTM A967
ATS-PPS-09	MUSIC WIRE COIL SPRING, QTY 1	5.3	0.6	4.4	11.1	2.7	0.2	Music Wire	Zinc Plate
ATS-PPS-10	MUSIC WIRE COIL SPRING, QTY 1	5.3	0.6	4.2	19.1	6.3	0.2	Music Wire	Zinc Plate
ATS-PPS-11	MUSIC WIRE COIL SPRING, QTY 1	5.3	0.7	4.2	17.5	5.8	0.3	Music Wire	Zinc Plate
ATS-PPS-12	MUSIC WIRE COIL SPRING, QTY 1	5.3	0.6	4.0	15.9	6.9	0.5	Music Wire	Zinc Plate
ATS-PPS-13	MUSIC WIRE COIL SPRING, QTY 1	5.5	0.7	4.1	14.3	6.2	0.8	Music Wire	Zinc Plate
ATS-PPS-14	STAINLESS STEEL COIL SPRING, QTY 1	6.1	0.8	4.5	8.0	4.1	2.0	SS Type 302	Passivate per ASTM A967
ATS-PPS-15	STAINLESS STEEL COIL SPRING, QTY 1	6.4	0.5	5.3	11.1	2.6	0.2	SS Type 302	Passivate per ASTM A967
ATS-PPS-16	MUSIC WIRE COIL SPRING, QTY 1	6.1	0.8	4.5	9.7	4.3	2.0	Music Wire	Zinc Plate
ATS-PPS-17	MUSIC WIRE COIL SPRING, QTY 1	6.1	1.0	4.1	12.7	8.0	3.3	Music Wire	Zinc Plate
ATS-PPS-18	MUSIC WIRE COIL SPRING, QTY 1	6.1	0.7	4.6	12.7	5.3	0.9	Music Wire	Zinc Plate
ATS-PPS-19	MUSIC WIRE COIL SPRING, QTY 1	6.1	0.8	4.5	11.1	5.1	1.7	Music Wire	Zinc Plate
ATS-PPS-20	MUSIC WIRE COIL SPRING, QTY 1	6.1	0.9	4.3	8.0	4.9	3.5	Music Wire	Zinc Plate
ATS-PPS-21	MUSIC WIRE COIL SPRING, QTY 1	6.4	0.7	4.8	11.2	3.6	0.8	Music Wire	Zinc Plate



NOTES:

OD = Outside Diameter
 WD = Wire Diameter
 ID = Inside Diameter
 FL = Free Length
 SL = Solid Length