



# Fast Dual Driver for ATE with Waveform Shaping

MAX9957

## General Description

The MAX9957 dual driver IC for automatic test equipment (ATE) memory applications offers three-level drive capability, high-speed switching, low timing dispersion, and features voltage-controlled waveform shaping to enhance edge-placement accuracy and minimize distortion. It also provides tight matching of gain and offset. The MAX9957 buffers reference voltage inputs for each channel with nominal -1V to +3.5V voltage ranges. High-speed differential control inputs, compatible with CML levels, are provided for each channel. Static power dissipation is only 1500mW per channel with nominal -5V and +7V supplies. The MAX9957 power dissipation at 2Gbps toggling is only 1550mW/channel. The MAX9957D power dissipation at 2.4Gbps is only 1850mW/channel.

The MAX9957 is available in a 10mm x 10mm x 1mm, 64-pin TQFP package with an exposed pad, inverted die pad for ease of heat removal.

## Applications

Automatic Test Equipment  
 DDR2 Memory Testers  
 GDDR3  
 GDDR4

## Typical Operating Circuit

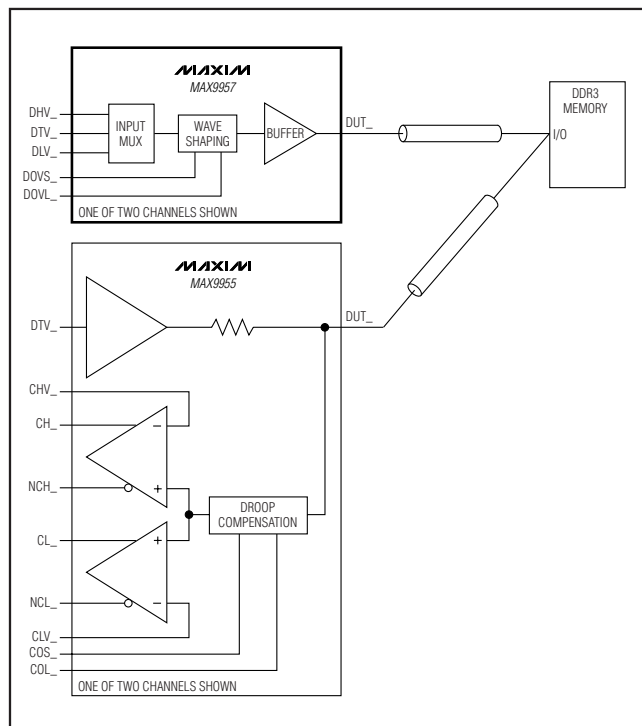

## Features

- ◆ Terminator/3-Level Driver
- ◆ 2Gbps Toggling at 2V<sub>P-P</sub> (MAX9957)
- ◆ 2.4Gbps Toggling at 2V<sub>P-P</sub> (MAX9957D)
- ◆ Voltage-Controlled Waveform Shaping
- ◆ Interfaces Easily With Most Logic Families
- ◆ Low Timing Dispersion

## Ordering Information

PART	TEMP RANGE	PIN-PACKAGE
MAX9957CCB-D	0°C to +70°C	64 TQFP-EPR*
MAX9957CCB+D	0°C to +70°C	64 TQFP-EPR*
MAX9957DCCB+D	0°C to +70°C	64 TQFP-EPR*

-Denotes a package containing lead(Pb).

D = Dry pack.

+Denotes a lead(Pb)-free/RoHS-compliant package.

\*EPR = Exposed pad reversed (exposed pad on top of device).

## Pin Configuration

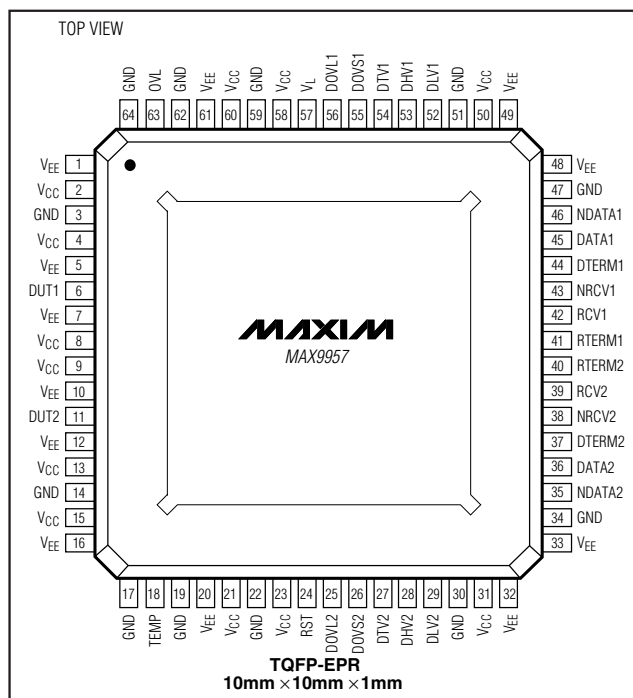

# Fast Dual Driver for ATE with Waveform Shaping

## ABSOLUTE MAXIMUM RATINGS

V <sub>CC</sub> to GND	-0.3V to +8V	DHV <sub>-</sub> , DLV <sub>-</sub> , DTV <sub>-</sub> to GND (MAX9957)	-2V to +4.5V
V <sub>EE</sub> to GND	-6V to +0.3V	DHV <sub>-</sub> , DLV <sub>-</sub> , DTV <sub>-</sub> to GND (MAX9957D)	-1.7V to +4.5V
V <sub>CC</sub> - V <sub>EE</sub>	-0.3V to +14V	DOVS <sub>-</sub> , DOVL <sub>-</sub> to GND	-0.3V to +4.1V
V <sub>L</sub> to GND	-0.3V to +4.1V	OVL to GND	-0.3V to (V <sub>L</sub> + 0.3V)
DUT <sub>-</sub> to GND	-2V to +4.5V	All Other Pins to GND	(V <sub>EE</sub> - 0.3V) to (V <sub>CC</sub> + 0.3V)
DATA <sub>-</sub> , NDATA <sub>-</sub> , RCV <sub>-</sub> , NRCV <sub>-</sub> to GND	-0.3V to 4.1V	TEMP Current	-0.5mA to +20mA
DATA <sub>-</sub> to NDATA <sub>-</sub> , RCV <sub>-</sub> to NRCV <sub>-</sub>	±1.5V	DUT <sub>-</sub> Current	-80mA to +80mA
V <sub>DTERM<sub>-</sub></sub> - V <sub>DATA<sub>-</sub></sub>	+2V to -0.3V	DUT <sub>-</sub> Short Circuit to -1V to +3.5V	Continuous
V <sub>DTERM<sub>-</sub></sub> - V <sub>NDATA<sub>-</sub></sub>	+2V to -0.3V	Package Power Dissipation (T <sub>A</sub> = +70°C)	64-Pin TQFP-EP-IDP (derate 125mW/°C above +70°C) ... 10W
V <sub>RTERM<sub>-</sub></sub> - V <sub>RCV<sub>-</sub></sub>	+2V to -0.3V	Storage Temperature Range	-65°C to +150°C
V <sub>RTERM<sub>-</sub></sub> - V <sub>NRCV<sub>-</sub></sub>	+2V to -0.3V	Junction Temperature	+125°C
DTERM <sub>-</sub> , RTERM <sub>-</sub> to GND	-0.3V to +4.1V	Lead Temperature (soldering, 10s)	+300°C
RST to GND	-0.3V to (V <sub>L</sub> + 0.3V)		

Stresses beyond those listed under "Absolute Maximum Ratings" may cause permanent damage to the device. These are stress ratings only, and functional operation of the device at these or any other conditions beyond those indicated in the operational sections of the specifications is not implied. Exposure to absolute maximum rating conditions for extended periods may affect device reliability.

## ELECTRICAL CHARACTERISTICS

(V<sub>CC</sub> = +7V, V<sub>EE</sub> = -5V, V<sub>L</sub> = +3.3V, V<sub>RTERM<sub>-</sub></sub> = V<sub>DTERM<sub>-</sub></sub> = +3.3V, V<sub>DHV<sub>-</sub></sub> = +2V, V<sub>DLV<sub>-</sub></sub> = 0V, V<sub>DTV<sub>-</sub></sub> = +1V, V<sub>DOVS<sub>-</sub></sub> = V<sub>DOVL<sub>-</sub></sub> = 0V, T<sub>J</sub> = +70°C ±10°C, unless otherwise noted. All temperature coefficients are measured at T<sub>J</sub> = +50°C to +90°C.)

PARAMETER	SYMBOL	CONDITIONS	MIN	TYP	MAX	UNITS
<b>DC CHARACTERISTICS (Note 1)</b>						
Voltage Range			-1.0		+3.5	V
Voltage Swing			0.1		4.0	V
Gain (Note 2)		DHV: V <sub>DHV<sub>-</sub></sub> = 0 and 2.5V, V <sub>DLV<sub>-</sub></sub> = -1V, V <sub>DTV<sub>-</sub></sub> = 1.5V	0.997	1.000	1.003	V/V
		DTV: V <sub>DTV<sub>-</sub></sub> = 0 and 2.5V, V <sub>DLV<sub>-</sub></sub> = -1V, V <sub>DHV<sub>-</sub></sub> = 3.5V	0.997	1.000	1.003	
		DLV: V <sub>DHV<sub>-</sub></sub> = 3.5V, V <sub>DLV<sub>-</sub></sub> = 0 and 2.5V, V <sub>DTV<sub>-</sub></sub> = 1.5V	0.997	1.000	1.003	
Gain Temperature Coefficient		DHV: V <sub>DHV<sub>-</sub></sub> = 0 and 2.5V, V <sub>DLV<sub>-</sub></sub> = -1V, V <sub>DTV<sub>-</sub></sub> = 1.5V		-70		ppm/°C
		DTV: V <sub>DTV<sub>-</sub></sub> = 0 and 2.5V, V <sub>DLV<sub>-</sub></sub> = -1V, V <sub>DHV<sub>-</sub></sub> = 3.5V		-60		
		DLV: V <sub>DHV<sub>-</sub></sub> = 3.5V, V <sub>DLV<sub>-</sub></sub> = 0 and 2.5V, V <sub>DTV<sub>-</sub></sub> = 1.5V		-70		
Offset		DHV: V <sub>DHV<sub>-</sub></sub> = 2V, V <sub>DLV<sub>-</sub></sub> = -1V, V <sub>DTV<sub>-</sub></sub> = 1.5V			±20	mV
		DTV: V <sub>DHV<sub>-</sub></sub> = 3.5V, V <sub>DLV<sub>-</sub></sub> = -1V, V <sub>DTV<sub>-</sub></sub> = 1V			±20	
		DLV: V <sub>DHV<sub>-</sub></sub> = 3.5V, V <sub>DLV<sub>-</sub></sub> = 0V, V <sub>DTV<sub>-</sub></sub> = 1.5V			±20	

# Fast Dual Driver for ATE with Waveform Shaping

MAX9957

## ELECTRICAL CHARACTERISTICS (continued)

(V<sub>CC</sub> = +7V, V<sub>EE</sub> = -5V, V<sub>L</sub> = +3.3V, V<sub>RTERM\_</sub> = V<sub>DTERM\_</sub> = +3.3V, V<sub>DHV\_</sub> = +2V, V<sub>DLV\_</sub> = 0V, V<sub>DTV\_</sub> = +1V, V<sub>Dovs\_</sub> = V<sub>DovL\_</sub> = 0V, T<sub>J</sub> = +70°C ±10°C, unless otherwise noted. All temperature coefficients are measured at T<sub>J</sub> = +50°C to +90°C.)

PARAMETER	SYMBOL	CONDITIONS	MIN	TYP	MAX	UNITS	
Offset Temperature Coefficient		DHV: V <sub>DHV_</sub> = 2V, V <sub>DLV_</sub> = -1V, V <sub>DTV_</sub> = 1.5V		-100		μV/°C	
		DTV: V <sub>DHV_</sub> = 3.5V, V <sub>DLV_</sub> = -1V, V <sub>DTV_</sub> = 1V		-40			
		DLV: V <sub>DHV_</sub> = 3.5V, V <sub>DLV_</sub> = 0V, V <sub>DTV_</sub> = 1.5V		+60			
DC Output Current		DHV: V <sub>DLV_</sub> = -1V, V <sub>DHV_</sub> / V <sub>DUT_</sub> = 3.50V / 1.25V, and 1.25V / 3.50V	±40			mA	
		DLV: V <sub>DHV_</sub> = 3.5V, V <sub>DLV_</sub> / V <sub>DUT_</sub> = +1.25V / -1V and -1V / +1.25V	±40				
DC Output Resistance		I <sub>DUT_</sub> = ±20mA, V <sub>DUT_</sub> = V <sub>DHV_</sub> = 1.25V (Note 3)	48	50	52	Ω	
DC Output Resistance Variation		I <sub>DUT_</sub> = ±1mA, ±8mA; V <sub>DUT_</sub> = V <sub>DHV_</sub> = 1.25V		0.3	1.0	Ω	
		I <sub>DUT_</sub> = ±1mA, ±8mA, ±15mA, ±40mA; V <sub>DUT_</sub> = V <sub>DHV_</sub> = 1.25V	MAX9957		1.1		2.0
			MAX9957D		1.5		3.0
Linearity Error (Note 2)		DHV: V <sub>DHV_</sub> = -1V to +3.5V, V <sub>DLV_</sub> = -1V, V <sub>DTV_</sub> = 1.5V			±15	mV	
		DTV: V <sub>DHV_</sub> = 3.5V, V <sub>DLV_</sub> = -1V, V <sub>DTV_</sub> = -1V to +3.5V			±15		
		DLV: V <sub>DHV_</sub> = 3.5V, V <sub>DLV_</sub> = -1V to +3.5V, V <sub>DTV_</sub> = 1.5V			±15		
Power-Supply Rejection Ratio		(Note 4)			±18	mV/V	
DC Crosstalk		(Note 5)			±5	mV	
<b>AC CHARACTERISTICS (Z<sub>L</sub> = 50Ω) (Notes 6, 7)</b>							
Prop Delay, Data to Output		V <sub>DHV_</sub> = 2V, V <sub>DLV_</sub> = 0V (Note 12)	MAX9957	0.75	1.00	1.25	ns
			MAX9957D	0.55	0.80	1.05	
Prop-Delay Temperature Coefficient				+0.85		ps/°C	
Prop Delay Match, TLH to THL		V <sub>DHV_</sub> = 2V, V <sub>DLV_</sub> = 0V (Note 12)			±100	ps	
Prop Delay Skew, Channel-to-Channel		Same edges (LH and HL)		±50		ps	
Prop Delay Change Versus Pulse Width		2V <sub>P-P</sub> , 40MHz, 0.5ns to 24.5ns pulse width, relative to 12.5ns pulse width		±15		ps	
Prop Delay Change Versus Common-Mode Voltage		1V <sub>P-P</sub> , V <sub>DLV_</sub> = -0.5V to +2V, relative to V <sub>DLV_</sub> = 0.75V		±10		ps	

# Fast Dual Driver for ATE with Waveform Shaping

## ELECTRICAL CHARACTERISTICS (continued)

( $V_{CC} = +7V$ ,  $V_{EE} = -5V$ ,  $V_L = +3.3V$ ,  $V_{RTERM\_} = V_{DTERM\_} = +3.3V$ ,  $V_{DHV\_} = +2V$ ,  $V_{DLV\_} = 0V$ ,  $V_{DTV\_} = +1V$ ,  $V_{DOVS\_} = V_{DOVL\_} = 0V$ ,  $T_J = +70^{\circ}C \pm 10^{\circ}C$ , unless otherwise noted. All temperature coefficients are measured at  $T_J = +50^{\circ}C$  to  $+90^{\circ}C$ .)

PARAMETER	SYMBOL	CONDITIONS	MIN	TYP	MAX	UNITS	
Prop Delay, Data to Term and Term to Data		(Note 12)	MAX9957	0.73	0.98	1.23	ns
			MAX9957D	0.63	0.88	1.13	
Rise/Fall Time, 1V		$V_{DHV\_} = 1V$ , $V_{DTV\_} = 0.5V$ , $V_{DLV\_} = 0V$ , 20% to 80%	MAX9957	80	130	180	ps
			MAX9957D	70	120	160	
Rise/Fall Time, 2V		$V_{DHV\_} = 2V$ , $V_{DTV\_} = 1V$ , $V_{DLV\_} = 0V$ , 20% to 80%	MAX9957	100	150	200	ps
			MAX9957D	100	140	190	
Minimum Pulse Width, 1V		$V_{DHV\_} = 1V$ , $V_{DLV\_} = 0V$ , time to reach 95% amplitude (Note 12)	MAX9957		350	450	ps
			MAX9957D		270	370	
Minimum Pulse Width, 2V		$V_{DHV\_} = 2V$ , $V_{DLV\_} = 0V$ , time to reach 95% amplitude (Note 12)	MAX9957		400	500	ps
			MAX9957D		300	400	
Overshoot		0.5V to 2V swing (Notes 8 and 9)		(4% to 25%) + 25		mV	
Input Voltage Range, DOVS_/DOVL_		0V = no peaking, 3.3V = 25% peaking	0		3.3	V	
Undershoot		0.5V to 2V swing (Note 9)		1		%	
Output Return Loss By TDR		Drive amplitude = 1V, $V_{DLV\_} = 0V$ , $V_{DHV\_} = 1V$ , rise time = 150ps (10% to 90%) (Note 10)		5		%	
<b>DIFFERENTIAL CONTROL INPUTS (DATA_, NDATA_, RCV_, and NRCV_)</b>							
Input High Voltage			1.0		3.6	V	
Input Low Voltage			0.8		3.4	V	
Differential Input Voltage			$\pm 0.2$		$\pm 1.0$	V	
Voltage Between a Differential Input and its Termination			0		1.9	V	
Input Termination Voltage			1.7		3.6	V	
Input Termination Resistor			48	50	52	$\Omega$	
<b>SINGLE-ENDED INPUTS (DLV_, DHV_, DTV_, DOVS_, and DOVL_)</b>							
Input Bias Current					$\pm 25$	$\mu A$	
<b>SINGLE-ENDED INPUT (RST)</b>							
Input High Voltage			1.65		3.50	V	
Input Low Voltage			-0.10		+0.85	V	
Input Bias Current					$\pm 50$	$\mu A$	
<b>SINGLE-ENDED OUTPUT (OVL) (Note 7)</b>							
Digital Supply Voltage	$V_L$		3.00		3.60	V	
Digital Supply Current	$I_L$	No load	0.5	1.0	2.0	mA	
Output High Voltage		Load current = -1mA	$V_L - 0.4$		$V_L$	V	

# Fast Dual Driver for ATE with Waveform Shaping

MAX9957

## ELECTRICAL CHARACTERISTICS (continued)

( $V_{CC} = +7V$ ,  $V_{EE} = -5V$ ,  $V_L = +3.3V$ ,  $V_{RTERM\_} = V_{DTERM\_} = +3.3V$ ,  $V_{DHV\_} = +2V$ ,  $V_{DLV\_} = 0V$ ,  $V_{DTV\_} = +1V$ ,  $V_{DOVS\_} = V_{DOVL\_} = 0V$ ,  $T_J = +70^{\circ}C \pm 10^{\circ}C$ , unless otherwise noted. All temperature coefficients are measured at  $T_J = +50^{\circ}C$  to  $+90^{\circ}C$ .)

PARAMETER	SYMBOL	CONDITIONS	MIN	TYP	MAX	UNITS	
Output Low Voltage		Load current = 1mA	0		0.4	V	
Rise/Fall Time		10% to 90% (Note 11)		3.6		ns	
Overcurrent Detect Threshold		(Note 12)	$\pm 50$		$\pm 80$	mA	
<b>TEMPERATURE MONITOR</b>							
Nominal Voltage		$T_J = +70^{\circ}C$ , $R_L > 10M\Omega$		3.43		V	
Temperature Coefficient				+10		mV/ $^{\circ}C$	
Output Resistance			17	23	29	k $\Omega$	
<b>POWER SUPPLIES</b>							
Positive Voltage Range	$V_{CC}$		6.75	7.00	7.50	V	
Positive Supply Current	$I_{CC}$	MAX9957	204	222	240	mA	
		MAX9957D	245	265	285		
Negative Voltage Range	$V_{EE}$		-5.50	-5.00	-4.75	V	
Negative Supply Current	$I_{EE}$	MAX9957	260	283	306	mA	
		MAX9957D	295	330	360		
Static Power Dissipation		$f_{OUT} = 0Gbps$	MAX9957	2.4	3.0	3.6	W
		MAX9957D	3.05	3.5	4.15		
Operating Power Dissipation		$f_{OUT} = 2Gbps$ , 2V <sub>P-P</sub>	MAX9957	3.1		W	
		MAX9957D	3.7				

**Note 1:**  $R_L \geq 10M\Omega$ , unless otherwise noted. All specifications apply to DHV, DLV, and DTV.

**Note 2:** Relative to a straight line through 0 and 2.5V.

**Note 3:** Other values of DC output resistance are available on request, contact factory; 45 $\Omega$  to 51 $\Omega$ .

**Note 4:** Change in offset voltage with power supplies independently set to their minimum and maximum values.

**Note 5:** DC crosstalk is to be measured under six different conditions shown below with the worst case reported:

- 1) DTV to DHV:  $V_{DHV\_} = 3.5V$ ,  $V_{DLV\_} = 3.4V$ ,  $V_{DTV\_} = -1V$  to  $+3.5V$  (Driver Output: DHV)
- 2) DTV to DLV:  $V_{DHV\_} = -0.9V$ ,  $V_{DLV\_} = -1V$ ,  $V_{DTV\_} = -1V$  to  $+3.5V$  (Driver Output: DLV)
- 3) DHV to DLV:  $V_{DTV\_} = -1V$ ,  $V_{DLV\_} = -1V$ ,  $V_{DHV\_} = -0.9V$  to  $+3.5V$  (Driver Output: DLV)
- 4) DHV to DTV:  $V_{DTV\_} = -1V$ ,  $V_{DLV\_} = -1V$ ,  $V_{DHV\_} = -0.9V$  to  $+3.5V$  (Driver Output: DTV)
- 5) DLV to DHV:  $V_{DHV\_} = 3.5V$ ,  $V_{DTV\_} = 3.5V$ ,  $V_{DLV\_} = -1V$  to  $+3.4V$  (Driver Output: DHV)
- 6) DLV to DTV:  $V_{DHV\_} = 3.5V$ ,  $V_{DTV\_} = 3.5V$ ,  $V_{DLV\_} = -1V$  to  $+3.4V$  (Driver Output: DTV)

**Note 6:** Load is a terminated 3ns, 50 $\Omega$  transmission line with 50 $\Omega$  external termination resistor to GND, unless otherwise specified. Propagation delays are measured from the crossing point of the differential input signals to the 50% point of the expected output swing. Rise time of the differential inputs DATA<sub>-</sub> and RCV<sub>-</sub> is 300ps (10% to 90%).

**Note 7:** Guaranteed by design.

**Note 8:** Driver overshoot setting and output waveform. The voltage range of DOVS<sub>-</sub>, DOVL<sub>-</sub> is 0 to  $+3.3V$ , 0 is for no overshoot, and  $+3.3V$  is for 25% overshoot, respectively. The fall time of overshoot for DOVS<sub>-</sub> (90% to 10%) is 77ps, the fall time of overshoot for DOVL<sub>-</sub> (90% to 10%) is 1.5ns.

**Note 9:** The definitions of overshoot and undershoot are detailed in this figure:

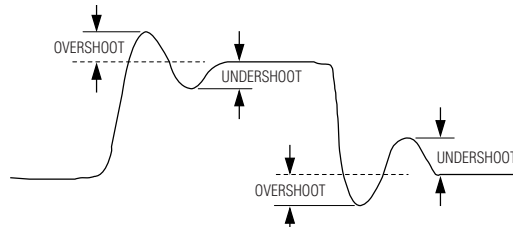

# Fast Dual Driver for ATE with Waveform Shaping

**Note 10:** The definition of output return loss by time domain reflectometry (TDR) is: output return loss = (reflection amplitude / drive amplitude) x 100 (%), with terms defined in this figure:

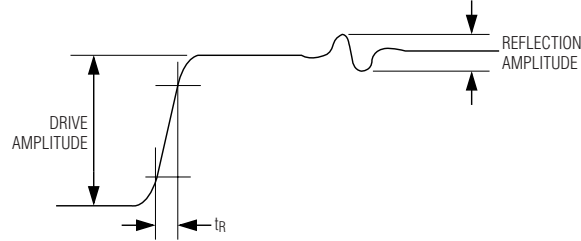

**Note 11:** Timing characteristics with  $V_L = 3.3V$ .

**Note 12:** Guaranteed by design. Not production tested.

## Typical Operating Characteristics (MAX9957)

( $V_{CC} = +7V$ ,  $V_{EE} = -5V$ ,  $V_L = +3.3V$ ,  $V_{RTERM\_} = V_{DTERM\_} = +3.3V$ ,  $V_{DHFV\_} = +2V$ ,  $V_{DLV\_} = 0V$ ,  $V_{DTV\_} = +1V$ ,  $V_{DOVS\_} = V_{DOVL\_} = 0V$ ,  $T_J = +70^{\circ}C \pm 10^{\circ}C$ , unless otherwise noted. All temperature coefficients are measured at  $T_J = +50^{\circ}C$  to  $+90^{\circ}C$ .)

**DRIVER SMALL-SIGNAL RESPONSE**

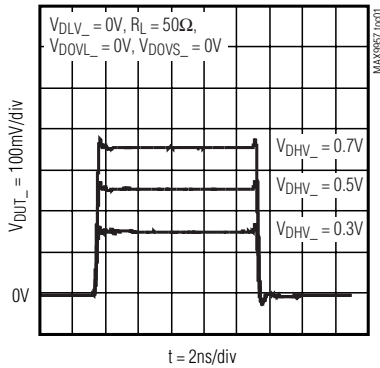

**DRIVER LARGE-SIGNAL RESPONSE**

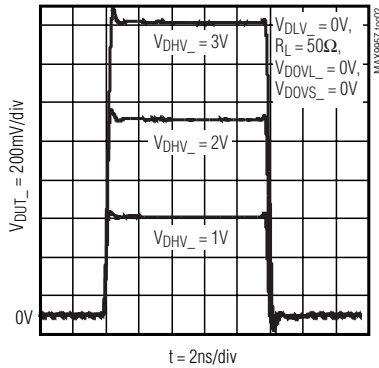

**DRIVER 1V, 2Gbps SIGNAL RESPONSE**

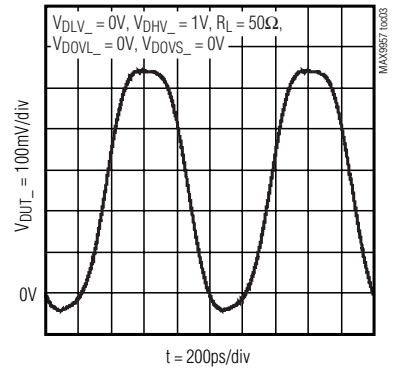

**DRIVER 1V, 3Gbps SIGNAL RESPONSE**

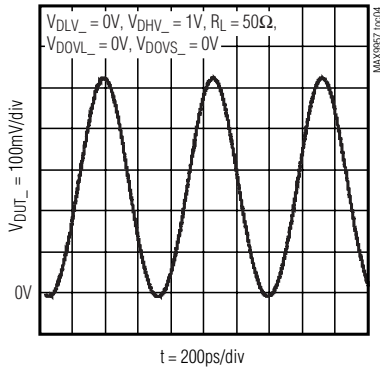

**DRIVER 2V, 2Gbps SIGNAL RESPONSE**

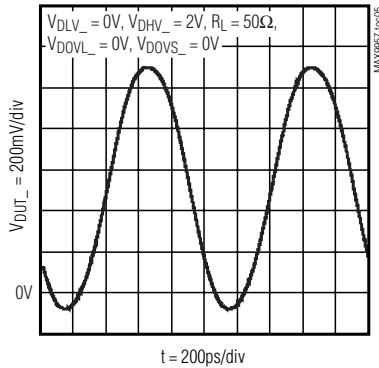

**DRIVER 3V, 1Gbps SIGNAL RESPONSE**

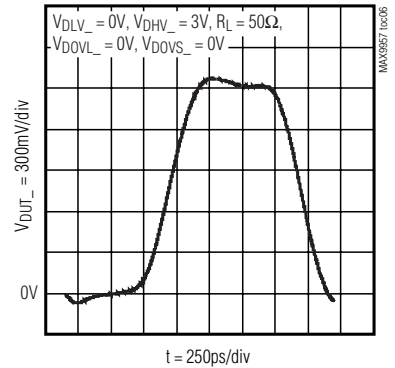

# Fast Dual Driver for ATE with Waveform Shaping

MAX9957

## Typical Operating Characteristics (MAX9957) (continued)

( $V_{CC} = +7V$ ,  $V_{EE} = -5V$ ,  $V_L = +3.3V$ ,  $V_{RTERM\_} = V_{DTERM\_} = +3.3V$ ,  $V_{DHFV\_} = +2V$ ,  $V_{DLV\_} = 0V$ ,  $V_{DTV\_} = +1V$ ,  $V_{DOVS\_} = V_{DOVL\_} = 0V$ ,  $T_J = +70^{\circ}C \pm 10^{\circ}C$ , unless otherwise noted. All temperature coefficients are measured at  $T_J = +50^{\circ}C$  to  $+90^{\circ}C$ .)

**DRIVER SIGNAL RESPONSE WITH DRIVER OVERSHOOT**

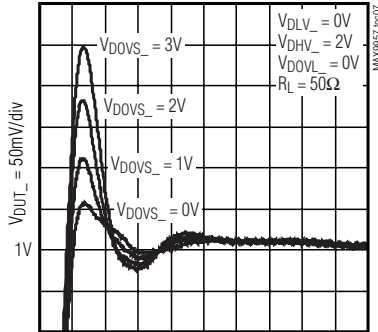

t = 250ps/div

**DRIVER SIGNAL RESPONSE WITH DRIVER OVERSHOOT**

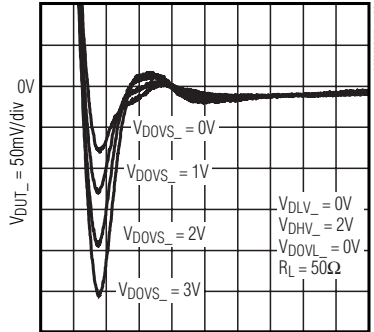

t = 250ps/div

**DRIVER SIGNAL RESPONSE WITH DRIVER OVERSHOOT**

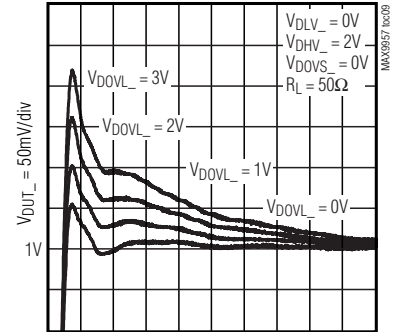

t = 500ps/div

**DRIVER SIGNAL RESPONSE WITH DRIVER OVERSHOOT**

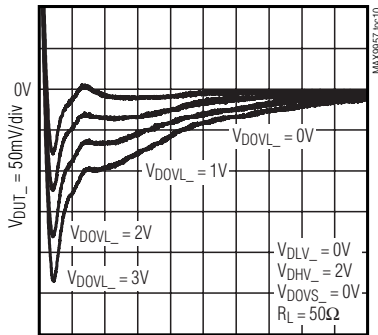

t = 500ps/div

**DRIVER OVERSHOOT vs. DOVS\_ VOLTAGE**

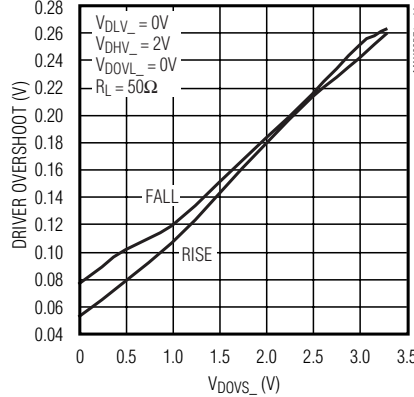

**DRIVER OVERSHOOT vs. DOVL\_ VOLTAGE**

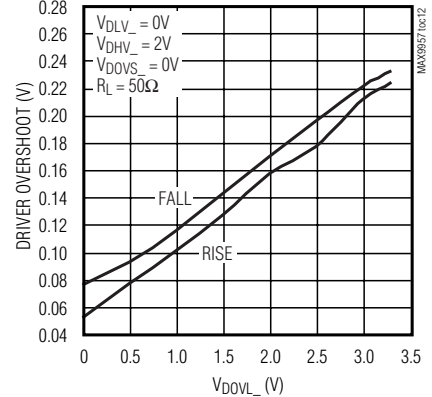

**DRIVER 2V TRAILING EDGE ERROR vs. PULSE WIDTH**

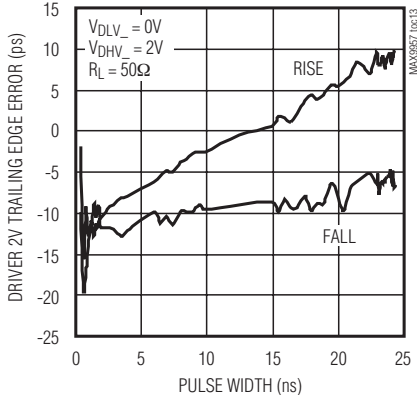

**DRIVER 2V TRAILING EDGE ERROR vs. PULSE WIDTH**

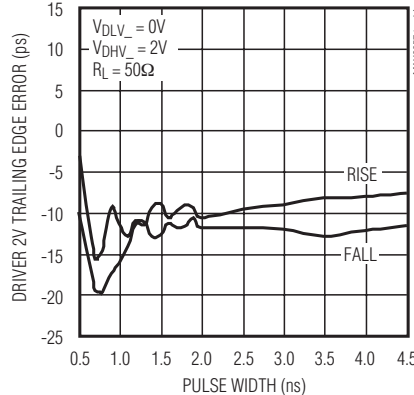

**DRIVER TIME DELAY vs. COMMON-MODE VOLTAGE**

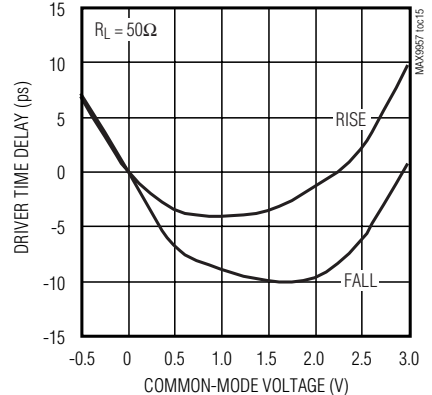

# Fast Dual Driver for ATE with Waveform Shaping

## Typical Operating Characteristics (MAX9957) (continued)

( $V_{CC} = +7V$ ,  $V_{EE} = -5V$ ,  $V_L = +3.3V$ ,  $V_{RTERM\_} = V_{DTERM\_} = +3.3V$ ,  $V_{DHV\_} = +2V$ ,  $V_{DLV\_} = 0V$ ,  $V_{DTV\_} = +1V$ ,  $V_{DOVS\_} = V_{DOVL\_} = 0V$ ,  $T_J = +70^{\circ}C \pm 10^{\circ}C$ , unless otherwise noted. All temperature coefficients are measured at  $T_J = +50^{\circ}C$  to  $+90^{\circ}C$ .)

**DRIVE-TO-TERM TRANSITION**

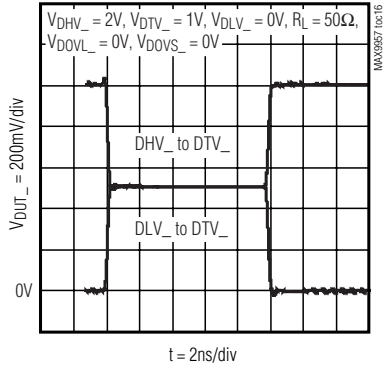

**DRIVER LINEARITY ERROR vs. OUTPUT VOLTAGE**

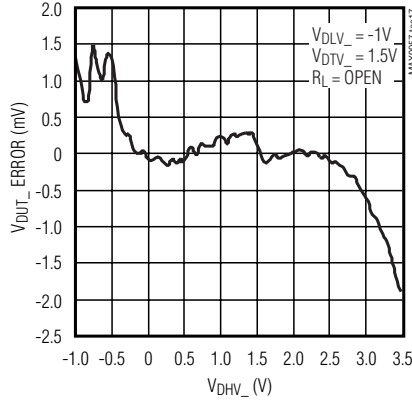

**DRIVER LINEARITY ERROR vs. OUTPUT VOLTAGE**

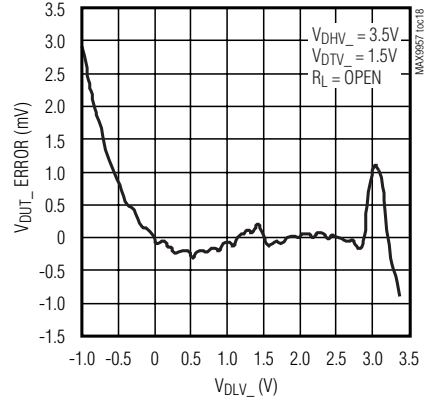

**DRIVER LINEARITY ERROR vs. OUTPUT VOLTAGE**

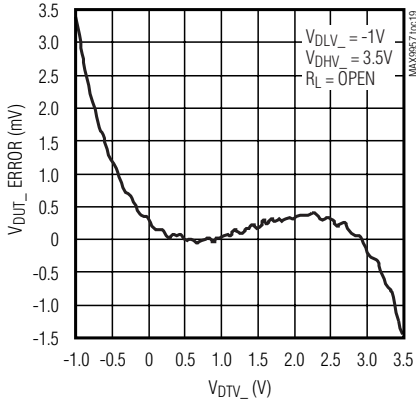

**CROSSTALK TO DUT FROM DLV\_ WITH DUT = DTV\_**

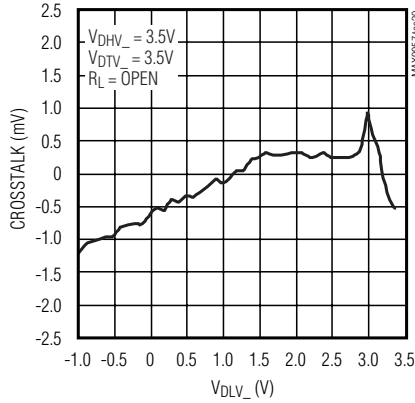

**CROSSTALK TO DUT FROM DHV\_ WITH DUT = DTV\_**

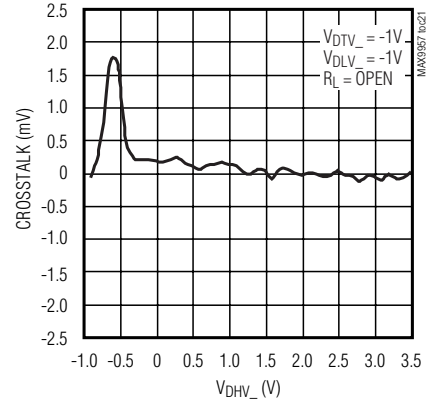

**CROSSTALK TO DUT FROM DTV\_ WITH DUT = DHV\_**

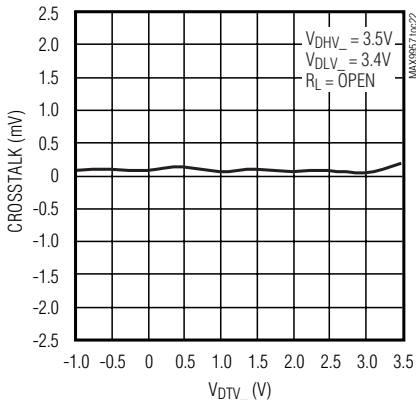

**CROSSTALK TO DUT FROM DTV\_ WITH DUT = DLV\_**

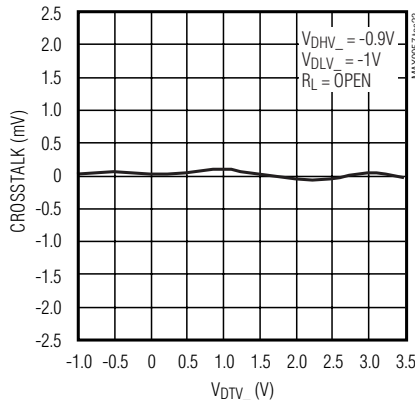

**CROSSTALK TO DUT FROM DLV\_ WITH DUT = DTV\_**

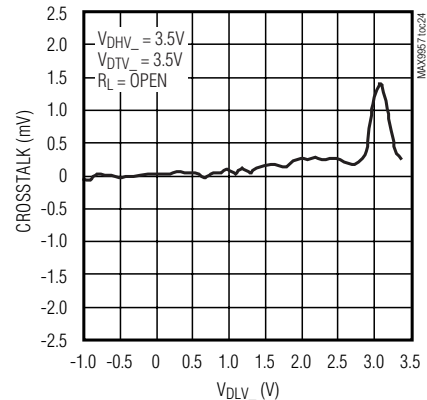



# Fast Dual Driver for ATE with Waveform Shaping

MAX9957

## Typical Operating Characteristics (MAX9957) (continued)

( $V_{CC} = +7V$ ,  $V_{EE} = -5V$ ,  $V_L = +3.3V$ ,  $V_{RTERM\_} = V_{DTERM\_} = +3.3V$ ,  $V_{DHFV\_} = +2V$ ,  $V_{DLV\_} = 0V$ ,  $V_{DTV\_} = +1V$ ,  $V_{DOVS\_} = V_{DOVL\_} = 0V$ ,  $T_J = +70^{\circ}C \pm 10^{\circ}C$ , unless otherwise noted. All temperature coefficients are measured at  $T_J = +50^{\circ}C$  to  $+90^{\circ}C$ .)

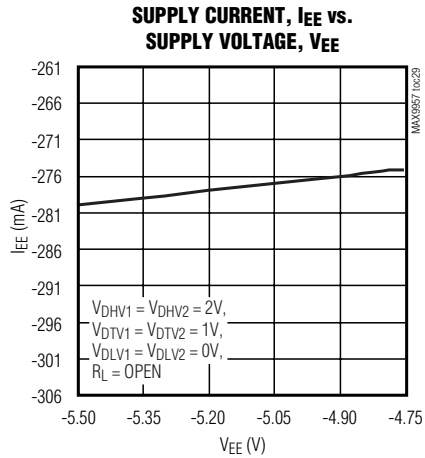
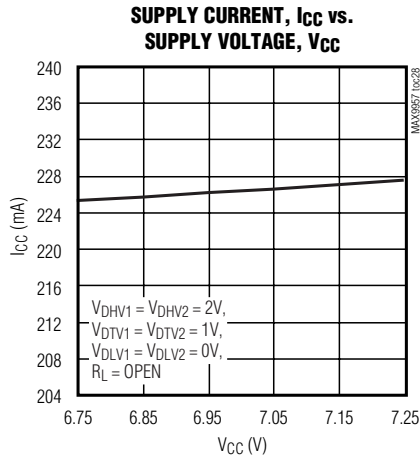
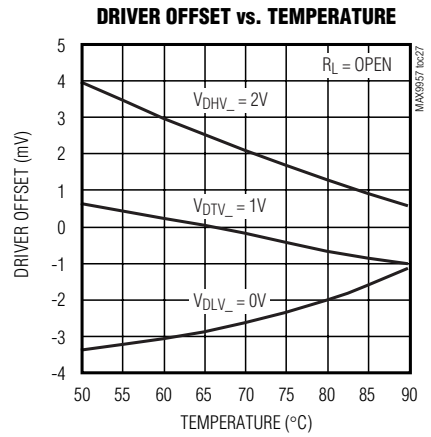
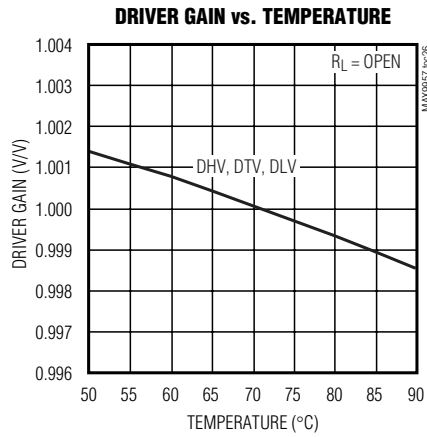
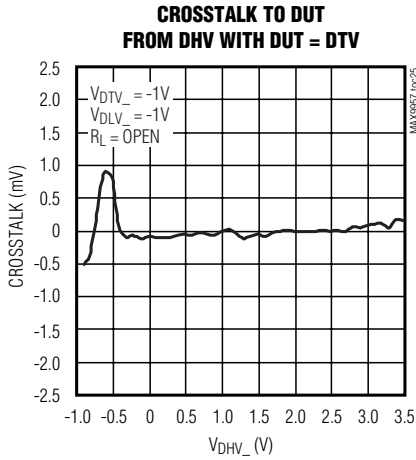

# Fast Dual Driver for ATE with Waveform Shaping

## Typical Operating Characteristics (MAX9957D)

( $V_{CC} = +7V$ ,  $V_{EE} = -5V$ ,  $V_L = +3.3V$ ,  $V_{RTERM\_} = V_{DTERM\_} = +3.3V$ ,  $V_{DHFV\_} = +2V$ ,  $V_{DLV\_} = 0V$ ,  $V_{DTV\_} = +1V$ ,  $V_{DOVS\_} = V_{DOVL\_} = 0V$ ,  $T_J = +70^{\circ}C \pm 10^{\circ}C$ , unless otherwise noted. All temperature coefficients are measured at  $T_J = +50^{\circ}C$  to  $+90^{\circ}C$ .)

**DRIVER SMALL-SIGNAL RESPONSE**

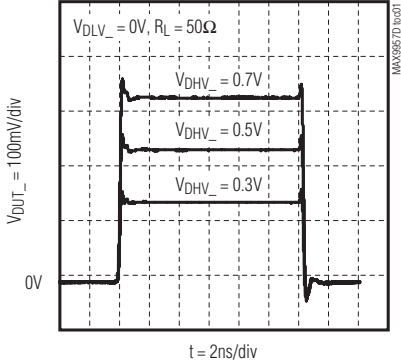

**DRIVER LARGE-SIGNAL RESPONSE**

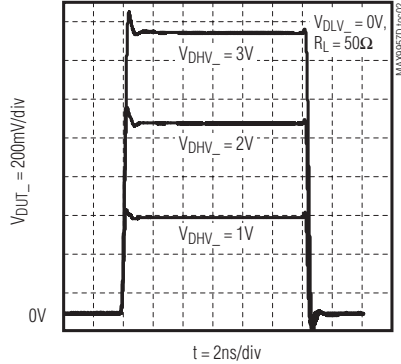

**DRIVER 1V, 2.4Gbps SIGNAL RESPONSE**

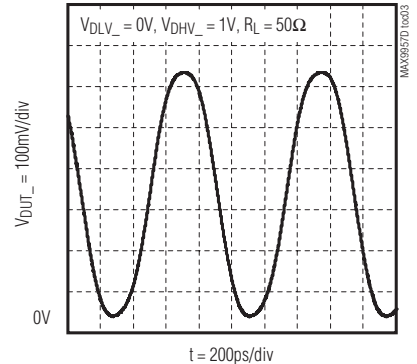

**DRIVER 1V, 3Gbps SIGNAL RESPONSE**

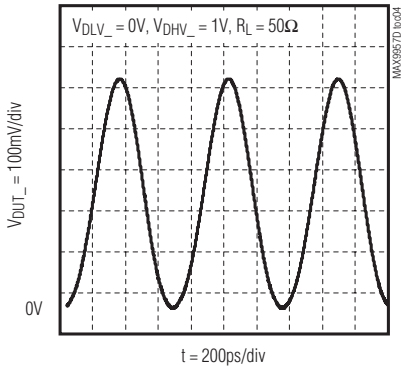

**DRIVER 2V, 2.4Gbps SIGNAL RESPONSE**

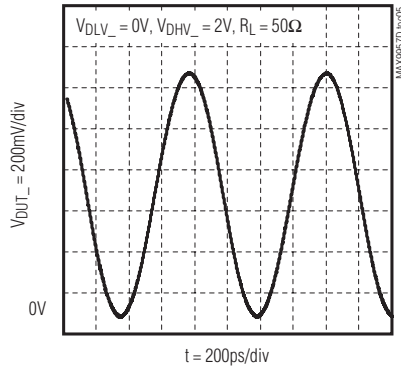

**DRIVER 3V, 1Gbps SIGNAL RESPONSE**

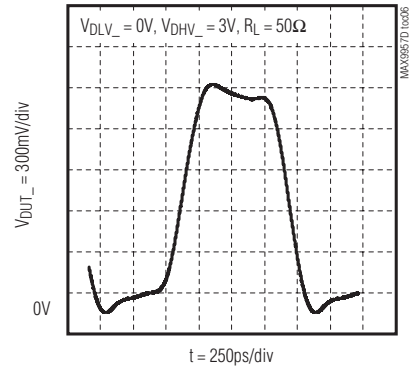

**DRIVER SIGNAL RESPONSE WITH DRIVER OVERSHOOT**

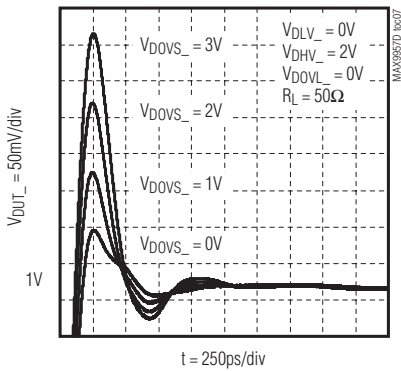

**DRIVER SIGNAL RESPONSE WITH DRIVER OVERSHOOT**

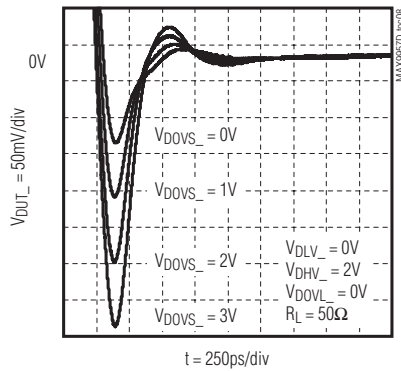

**DRIVER SIGNAL RESPONSE WITH DRIVER OVERSHOOT**

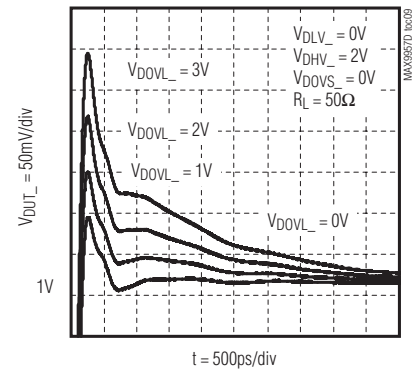

# Fast Dual Driver for ATE with Waveform Shaping

MAX9957

## Typical Operating Characteristics (MAX9957D) (continued)

( $V_{CC} = +7V$ ,  $V_{EE} = -5V$ ,  $V_L = +3.3V$ ,  $V_{RTERM\_} = V_{DTERM\_} = +3.3V$ ,  $V_{DHFV\_} = +2V$ ,  $V_{DLV\_} = 0V$ ,  $V_{DTV\_} = +1V$ ,  $V_{DOVS\_} = V_{DOVL\_} = 0V$ ,  $T_J = +70^{\circ}C \pm 10^{\circ}C$ , unless otherwise noted. All temperature coefficients are measured at  $T_J = +50^{\circ}C$  to  $+90^{\circ}C$ .)

**DRIVER SIGNAL RESPONSE WITH DRIVER OVERSHOOT**

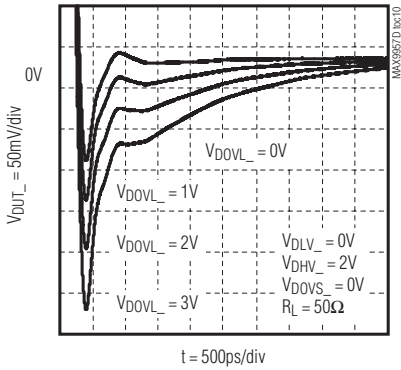

**DRIVER OVERSHOOT vs. DOVS\_ VOLTAGE**

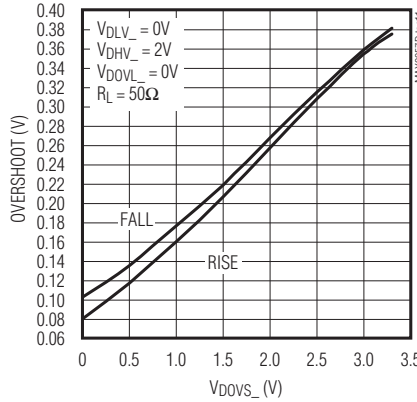

**DRIVER OVERSHOOT vs. DOVL\_ VOLTAGE**

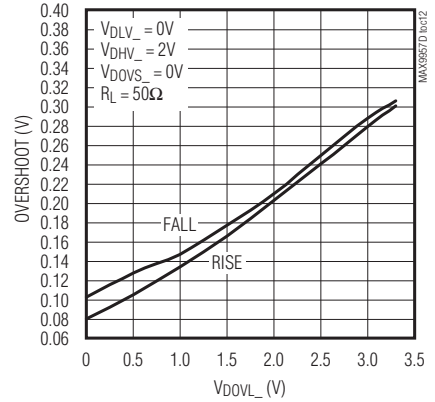

**DRIVER 2V TRAILING EDGE ERROR vs. PULSE WIDTH**

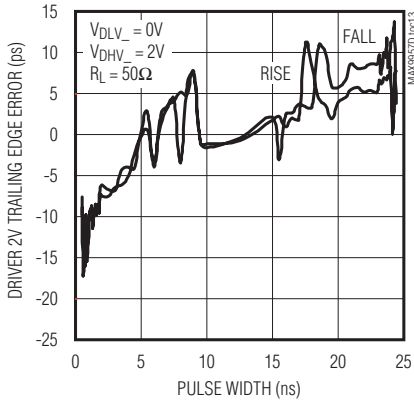

**DRIVER 2V TRAILING EDGE ERROR vs. PULSE WIDTH**

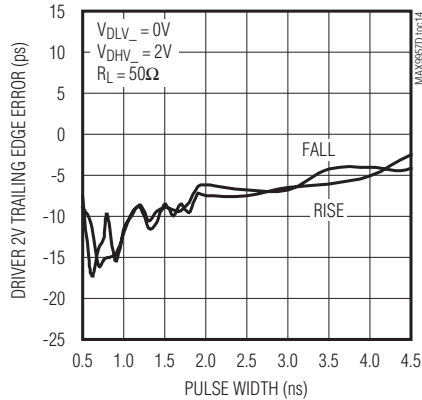

**DRIVER TIME DELAY vs. COMMON-MODE VOLTAGE**

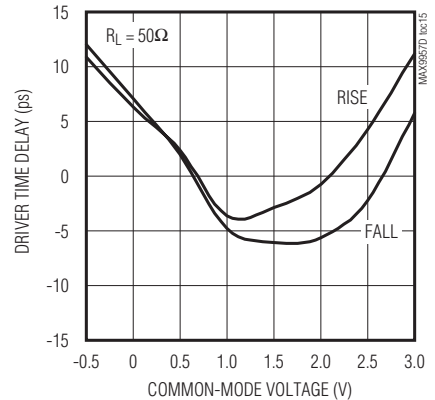

**DRIVE-TO-TERM TRANSITION**

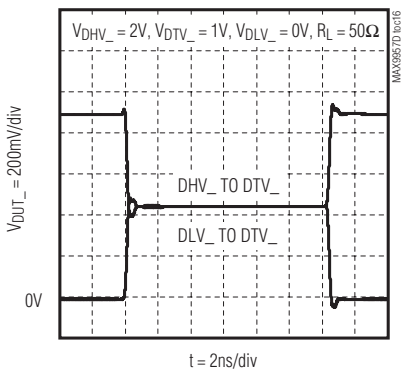

**DRIVER LINEARITY ERROR vs. OUTPUT VOLTAGE**

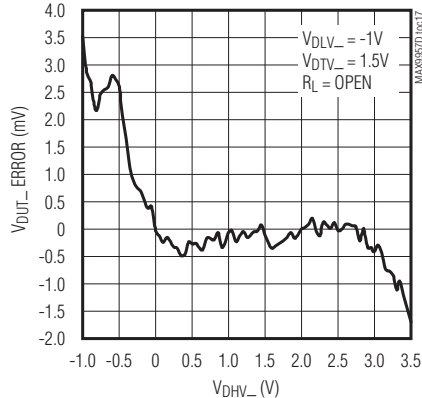

**DRIVER LINEARITY ERROR vs. OUTPUT VOLTAGE**

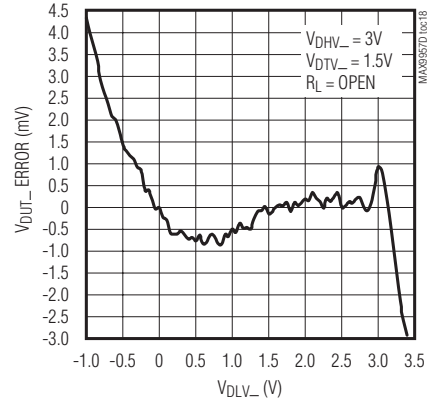

# Fast Dual Driver for ATE with Waveform Shaping

## Typical Operating Characteristics (MAX9957D) (continued)

( $V_{CC} = +7V$ ,  $V_{EE} = -5V$ ,  $V_L = +3.3V$ ,  $V_{RTERM\_} = V_{DTERM\_} = +3.3V$ ,  $V_{DHV\_} = +2V$ ,  $V_{DLV\_} = 0V$ ,  $V_{DTV\_} = +1V$ ,  $V_{DOVS\_} = V_{DOVL\_} = 0V$ ,  $T_J = +70^{\circ}C \pm 10^{\circ}C$ , unless otherwise noted. All temperature coefficients are measured at  $T_J = +50^{\circ}C$  to  $+90^{\circ}C$ .)

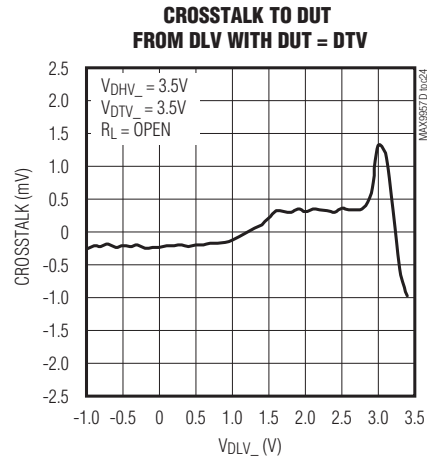
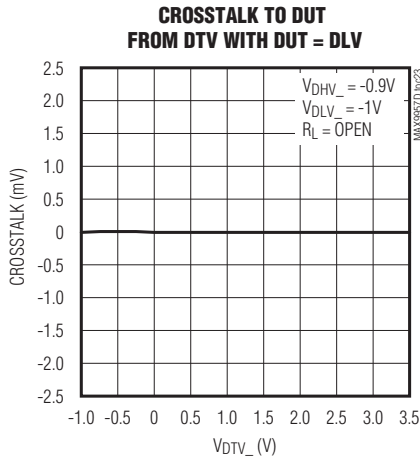
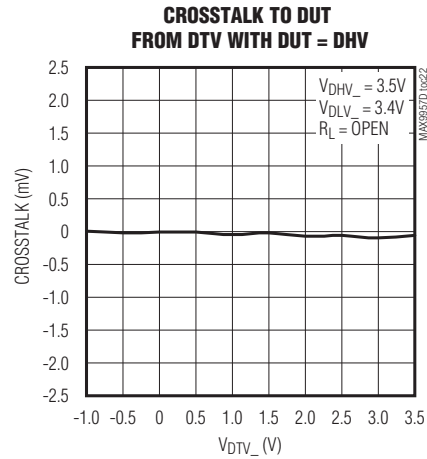
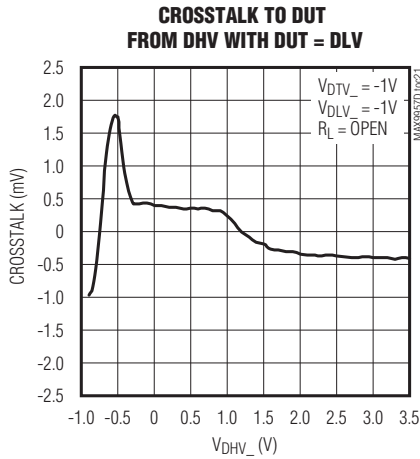
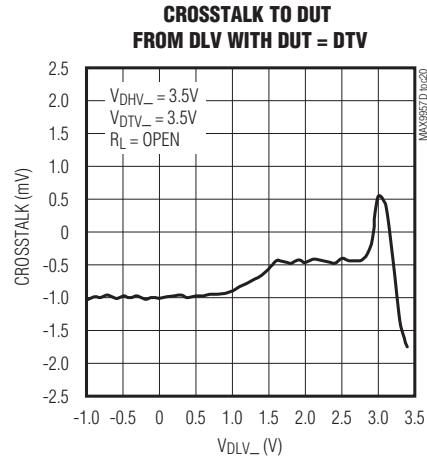
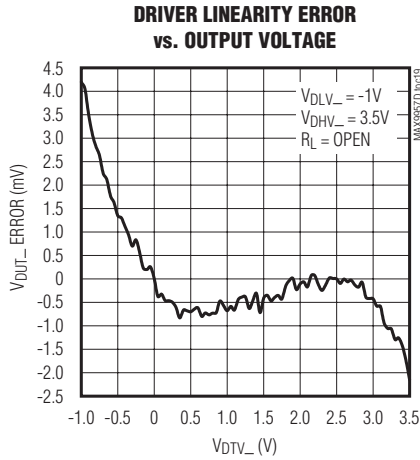

# Fast Dual Driver for ATE with Waveform Shaping

MAX9957

## Typical Operating Characteristics (MAX9957D) (continued)

( $V_{CC} = +7V$ ,  $V_{EE} = -5V$ ,  $V_L = +3.3V$ ,  $V_{RTERM\_} = V_{DTERM\_} = +3.3V$ ,  $V_{DHFV\_} = +2V$ ,  $V_{DLV\_} = 0V$ ,  $V_{DTV\_} = +1V$ ,  $V_{DOVS\_} = V_{DOVL\_} = 0V$ ,  $T_J = +70^\circ C \pm 10^\circ C$ , unless otherwise noted. All temperature coefficients are measured at  $T_J = +50^\circ C$  to  $+90^\circ C$ .)

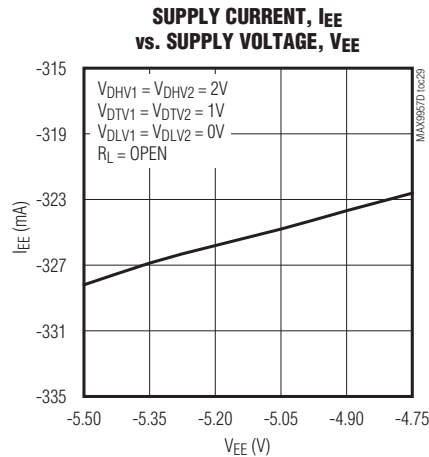
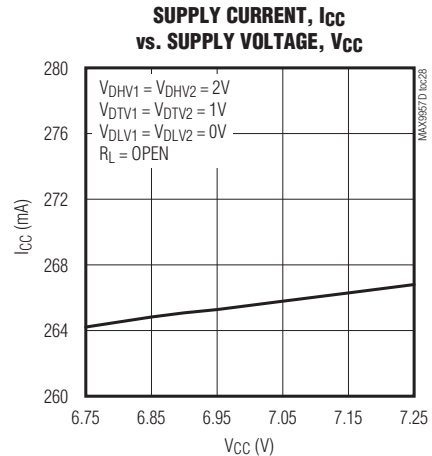
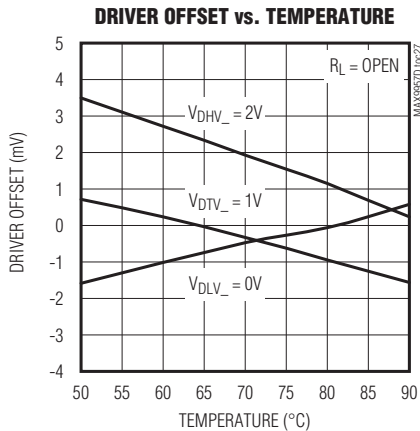
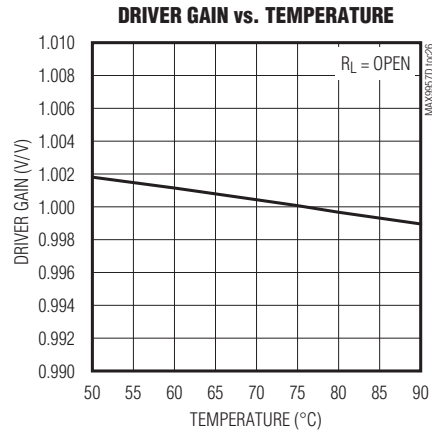
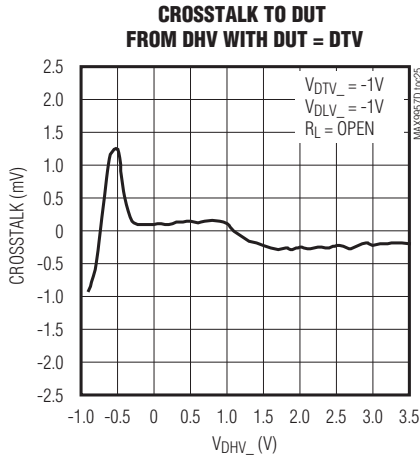

# Fast Dual Driver for ATE with Waveform Shaping

## Pin Description

PIN	NAME	FUNCTION
1, 5, 7, 10, 12, 16, 20, 32, 33, 48, 49, 61	VEE	Negative Power Supply
2, 4, 8, 9, 13, 15, 21, 23, 31, 50, 58, 60	VCC	Positive Power Supply
3, 14, 17, 19, 22, 30, 34, 47, 51, 59, 62, 64	GND	Ground
6	DUT1	Driver 1 Output
11	DUT2	Driver 2 Output
18	TEMP	Temperature Monitor Output
24	RST	Reset Input. Reset for the overcurrent detector. Clears the OVL output.
25	DOVL2	Driver Overshoot Voltage-Control Input, Long. Setting for DC waveform shaping for long-term overshoot of channel 2.
26	DOVS2	Driver Overshoot Voltage-Control Input, Short. Setting for DC waveform shaping for short-term overshoot of channel 2.
27	DTV2	Driver Term Voltage Input. DC input voltage for channel 2.
28	DHV2	Driver High Voltage Input. DC input voltage for channel 2.
29	DLV2	Driver Low Voltage Input. DC input voltage for channel 2.
35	NDA2	Multiplexer 2 Data Negative Control Input. NDATA and DATA form the differential multiplexer inputs that select between DHV and DLV for channel 2.
36	DATA2	Multiplexer 2 Data Positive Control Input. DATA and NDATA form the differential multiplexer inputs that select between DHV and DLV for channel 2.
37	DTERM2	Data Termination 2 Voltage Input. Termination voltage connection for DATA/NDATA input termination resistors of channel 2.
38	NRCV2	Multiplexer 2 Receive Negative Control Input. NRCV and RCV form the differential multiplexer inputs that select between DTV and DHV/DLV for channel 2.
39	RCV2	Multiplexer 2 Receive Positive Control Input. RCV and NRCV form the differential multiplexer inputs that select between DTV and DHV/DLV for channel 2.
40	RTERM2	Receive Termination 2 Voltage Input. Termination voltage connection for channel 2 RCV/NRCV input termination resistors.
41	RTERM1	Receive Termination 1 Voltage Input. Termination voltage connection for channel 1 RCV/NRCV input termination resistors.
42	RCV1	Multiplexer 1 Receive Positive Control Input. RCV and NRCV form the differential multiplexer inputs that select between DTV and DHV/DLV for channel 1.
43	NRCV1	Multiplexer 1 Receive Negative Control Input. NRCV and RCV form the differential multiplexer inputs that select between DTV and DHV/DLV for channel 1.

# Fast Dual Driver for ATE with Waveform Shaping

MAX9957

## Pin Description (continued)

PIN	NAME	FUNCTION
44	DTERM1	Data Termination 1 Voltage Input. Termination voltage connection for DATA/NDATA input termination resistors of channel 1.
45	DATA1	Multiplexer 1 Data Positive Control Input. DATA and NDATA form the differential multiplexer inputs that select between DHV and DLV for channel 1.
46	NDATA1	Multiplexer 1 Data Negative Control Input. NDATA and DATA form the differential multiplexer inputs that select between DHV and DLV for channel 1.
52	DLV1	Driver Low Voltage Input. DC input voltage for channel 1.
53	DHV1	Driver High Voltage Input. DC input voltage for channel 1.
54	DTV1	Driver Term Voltage Input. DC input voltage for channel 1.
55	DOVS1	Driver Overshoot Voltage-Control Input, Short. Setting for DC waveform shaping for short-term overshoot of channel 1.
56	DOVL1	Driver Overshoot Voltage-Control Input, Long. Setting for DC waveform shaping for long-term overshoot of channel 1.
57	VL	Logic Power-Supply Input
63	OVL	Overcurrent Detect Output. Clear OVL with the RST input.
—	EP	Exposed Pad for Heat Removal. Internally connected to V <sub>EE</sub> . Connect to V <sub>EE</sub> or leave unconnected. Do not use as the primary V <sub>EE</sub> connection.

## Detailed Description

The MAX9957 dual driver IC for ATE features voltage-controlled waveform shaping to enhance edge-placement accuracy and minimize distortion. The MAX9957 offers three-level drive capability, high-speed switching, and low timing dispersion. Input reference voltages are buffered for each channel and have nominal -1V to +3.5V voltage ranges. Static power dissipation is only 1500mW per channel, with nominal -5V and +7V supplies, and power dissipation at 2Gbps toggling is only 1550mW/channel. Figure 1 shows a functional diagram of the MAX9957.

### The Driver

The driver input is a high-speed multiplexer that selects one of three voltage inputs: DHV\_, DLV\_, or DTV\_. High-speed inputs DATA\_/NDATA\_ and RCV\_/NRCV\_ control the switching of the multiplexer, as shown in Table 1. The differential control inputs are compatible with ECL, LVPECL, LVDS, and GTL logic.

Table 1. Driver Logic

INPUT				OUTPUT
DATA_	NDATA_	RCV_	NRCV_	
L	H	L	H	Driver to DLV
H	L	L	H	Driver to DHV
X	X	H	L	Driver to DTV

X = Don't care.

The nominal driver output resistance is 50Ω. Contact the factory for different resistance values between 45Ω and 51Ω.

# Fast Dual Driver for ATE with Waveform Shaping

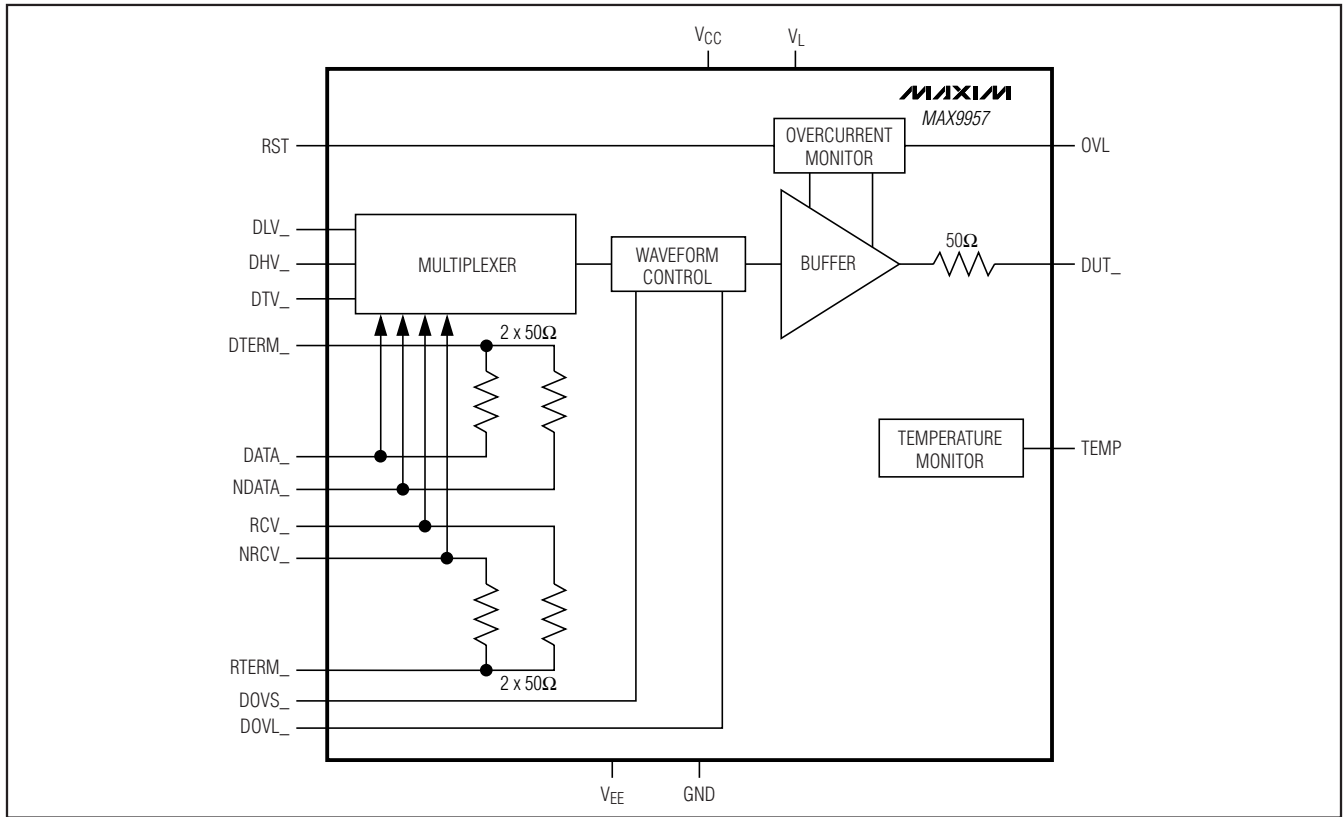

Figure 1. Functional Diagram

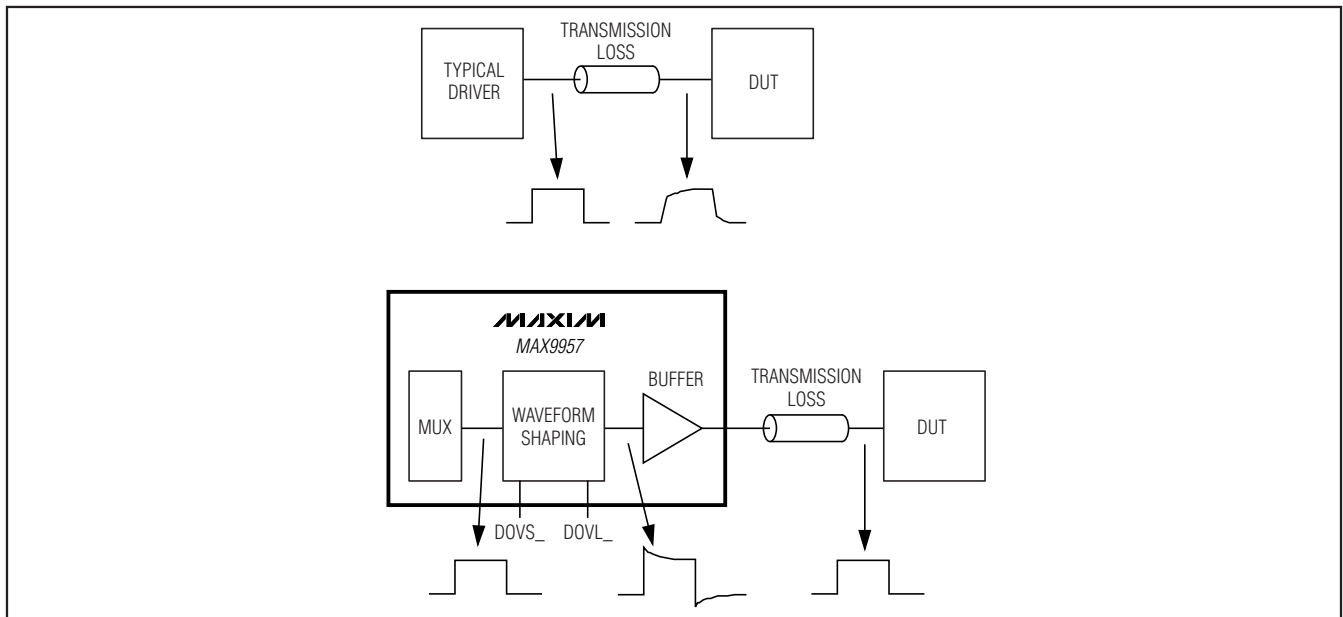

Figure 2. Waveform Shaping



# Fast Dual Driver for ATE with Waveform Shaping

## Waveform Shaping

The driver incorporates active waveform shaping. At high frequencies, transmission line effects degrade the output waveform fidelity as the signal travels from DUT\_ to the device under test. The waveform-shaping circuit compensates for this degradation by adding two single time-constant decaying waveforms to the nominal output waveform. Figure 2 depicts a comparison between a typical driver and the MAX9957, and shows how waveform shaping compensates for cable transmission degradation. In the frequency domain, the nominal output function is multiplied by two zero-pole pairs. Analog voltage inputs DOVS\_ (short) and DOVL\_ (long) control the peaking amplitude. Table 2 details the input levels for peaking amplitude control. The time constants are fixed. DOVS\_ varies the amplitude of the high-frequency boost (77ps (typ) time constant), while DOVL\_ varies the amplitude of the low-frequency boost (1.5ns (typ) time constant). See the *Typical Operating Characteristics* for peaking versus DOVS\_ and DOVL\_ voltages. Connect DOVS\_ and DOVL\_ to GND if compensation is not required.

## Overcurrent Detection

The MAX9957 monitors the buffer output current. If the current exceeds the overcurrent detect threshold, the output current is reduced and OVL latches high. Overcurrent detection is only a safety feature and not a trimmed or production-tested specification. The detection window is  $\pm 50\text{mA}$  to  $\pm 80\text{mA}$  and post-detection current is reduced to between  $\pm 20\text{mA}$  and  $\pm 30\text{mA}$ . Assert RST to return the buffer to normal operation and reset OVL. The single RST input controls both channels.

## Temperature Monitor

The MAX9957 supplies a temperature output signal (TEMP) that provides a nominal output voltage of 3.43V at a die temperature of 343K (+70°C). VTEMP changes proportionally with temperature at 10mV/°C.

## Chip Information

PROCESS: Bipolar

**Table 2. Waveform Shaping Control Inputs**

INPUT		OUTPUT
DOVS_	DOVL_	
0V	0V	Overshoot off
0V	0 to 3.3V	Overshoot (long)
0 to 3.3V	0V	Overshoot (short)
0 to 3.3V	0 to 3.3V	Overshoot (long + short)

**Table 3. Overcurrent Detection**

LOGIC INPUTS			LOGIC OUTPUT	DRIVER OUTPUT BUFFER MODE	
RST	OVERCURRENT DETECTION		OVL	DUT1	DUT2
	DUT1	DUT2			
X	↑	0	H	Off	On
X	0	↑	H	On	Off
X	↑	↑	H	Off	Off
↑	1	0	H	Off	On
↑	0	1	H	On	Off
↑	1	1	H	Off	Off
↑	0	0	L	On	On

X = Don't care.

↑ = Rising edge.

## Applications Information

### Heat Removal

Under normal circumstances, the MAX9957 requires heat removal through the exposed pad by use of an external heat sink. The exposed pad is electrically at VEE potential. The heatsink must be connected to VEE, or electrically isolated from the exposed pad.

### Power-Supply Considerations

Bypass all VCC, VEE, and VL power-supply inputs each with a 0.01μF capacitor and use bulk bypassing of at least 10μF on each supply where power enters the board.

## Package Information

For the latest package outline information and land patterns, go to [www.maxim-ic.com/packages](http://www.maxim-ic.com/packages). Note that a "+", "#", or "-" in the package code indicates RoHS status only. Package drawings may show a different suffix character, but the drawing pertains to the package regardless of RoHS status.

PACKAGE TYPE	PACKAGE CODE	DOCUMENT NO.
64 TQFP-EPR	C64E-9R	<a href="#">21-0162</a>

# Fast Dual Driver for ATE with Waveform Shaping

## Revision History

REVISION NUMBER	REVISION DATE	DESCRIPTION	PAGES CHANGED
0	8/07	Initial release	—
1	3/10	Added MAX9957D specifications to data sheet	1-4, 6, 7, 10-13

Maxim cannot assume responsibility for use of any circuitry other than circuitry entirely embodied in a Maxim product. No circuit patent licenses are implied. Maxim reserves the right to change the circuitry and specifications without notice at any time.

18 **Maxim Integrated Products, 120 San Gabriel Drive, Sunnyvale, CA 94086 408-737-7600**