



Noise suppression filter

For audio lines (Cellular band suppression)

MAF series

MAF1005G type

MAF1005G

1005 [0402 inch]*

* Dimensions Code JIS[EIA]

REMINDERS FOR USING THESE PRODUCTS

Before using these products, be sure to request the delivery specifications.

SAFETY REMINDERS

Please pay sufficient attention to the warnings for safe designing when using this products.

REMINDERS

- The storage period is less than 12 months. Be sure to follow the storage conditions (temperature: 5 to 40°C, humidity: 10 to 75% RH or less).
If the storage period elapses, the soldering of the terminal electrodes may deteriorate.
- Do not use or store in locations where there are conditions such as gas corrosion (salt, acid, alkali, etc.).
- Before soldering, be sure to preheat components.
The preheating temperature should be set so that the temperature difference between the solder temperature and chip temperature does not exceed 150°C.
- Soldering corrections after mounting should be within the range of the conditions determined in the specifications.
If overheated, a short circuit, performance deterioration, or lifespan shortening may occur.
- When embedding a printed circuit board where a chip is mounted to a set, be sure that residual stress is not given to the chip due to the overall distortion of the printed circuit board and partial distortion such as at screw tightening portions.
- Self heating (temperature increase) occurs when the power is turned ON, so the tolerance should be sufficient for the set thermal design.
- Carefully lay out the coil for the circuit board design of the non-magnetic shield type.
A malfunction may occur due to magnetic interference.
- Use a wrist band to discharge static electricity in your body through the grounding wire.
- Do not expose the products to magnets or magnetic fields.
- Do not use for a purpose outside of the contents regulated in the delivery specifications.
- The products listed on this catalog are intended for use in general electronic equipment (AV equipment, telecommunications equipment, home appliances, amusement equipment, computer equipment, personal equipment, office equipment, measurement equipment, industrial robots) under a normal operation and use condition.
The products are not designed or warranted to meet the requirements of the applications listed below, whose performance and/or quality require a more stringent level of safety or reliability, or whose failure, malfunction or trouble could cause serious damage to society, person or property.
If you intend to use the products in the applications listed below or if you have special requirements exceeding the range or conditions set forth in the each catalog, please contact us.

- (1) Aerospace/aviation equipment
- (2) Transportation equipment (cars, electric trains, ships, etc.)
- (3) Medical equipment
- (4) Power-generation control equipment
- (5) Atomic energy-related equipment
- (6) Seabed equipment
- (7) Transportation control equipment

- (8) Public information-processing equipment
- (9) Military equipment
- (10) Electric heating apparatus, burning equipment
- (11) Disaster prevention/crime prevention equipment
- (12) Safety equipment
- (13) Other applications that are not considered general-purpose applications

When designing your equipment even for general-purpose applications, you are kindly requested to take into consideration securing protection circuit/device or providing backup circuits in your equipment.

Noise suppression filter

For audio lines (Cellular band suppression)

Product compatible with RoHS directive
Halogen-free
Compatible with lead-free solders

Overview of MAF1005G type

FEATURES

- A compact noise suppression component for audio lines that accommodates high currents.
- Distortions are greatly reduced during insertion with the adoption of newly-developed low distortion ferrite materials.
- Small reductions in volume due to its low resistance, and optimal for devices that require high sound quality as the generating of sound distortions is controlled.
- Shows excellent effects in measures against the deterioration of the receiving sensitivity of wireless devices due to high attenuation characteristics in the cellular band.

APPLICATION

- Sound lines for devices such as smartphones and tablets (earphones, microphones, and speakers).
- Sound lines for portable game machines.

PART NUMBER CONSTRUCTION

MAF	1005		G	AD	152		A	T	0
Series name	LxW dimensions		Characteristics	Internal code	Impedance (Ω) at 900MHz		Type	Packaging style	Internal code
	1005	1.0x0.5x0.5	G Cellular Band		701	700	A		
					152	1500	D		
					262	2600			
					352	3500			

OPERATING TEMPERATURE RANGE, PACKAGE QUANTITY, PRODUCT WEIGHT

Type	Temperature range		Package quantity (pieces/reel)	Individual weight (mg)
	Operating temperature (°C)	Storage temperature* (°C)		
MAF1005G	-55 to +125	-55 to +125	10,000	1

* The storage temperature range is for after the assembly.

- RoHS Directive Compliant Product: See the following for more details. <https://product.tdk.com/info/en/environment/rohs/index.html>
- Halogen-free: indicates that Cl content is less than 900ppm, Br content is less than 900ppm, and that the total Cl and Br content is less than 1500ppm.

 Please be sure to request delivery specifications that provide further details on the features and specifications of the products for proper and safe use.
Please note that the contents may change without any prior notice due to reasons such as upgrading.

MAF1005G type

RECOMMENDED REFLOW PROFILE

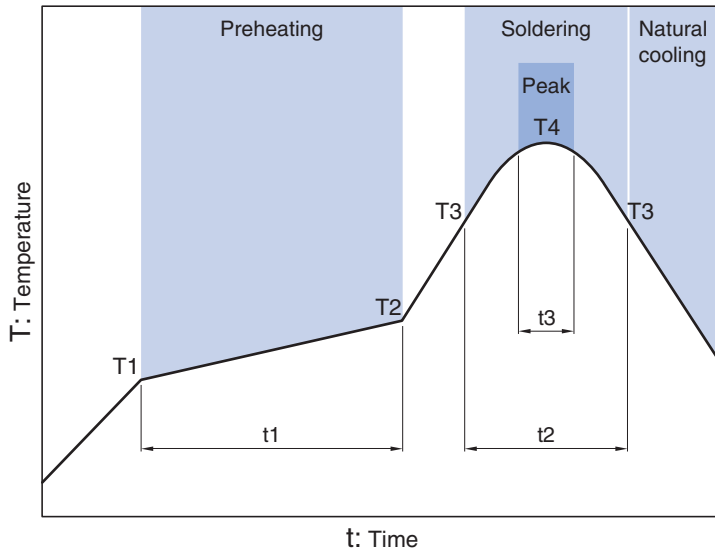

Preheating			Soldering		Peak	
Temp.		Time	Temp.	Time	Temp.	Time
T1	T2	t1	T3	t2	T4	t3
150°C	180°C	60 to 120s	230°C	30 to 60s	250 to 260°C	10s

MAF1005G type

SHAPE & DIMENSIONS

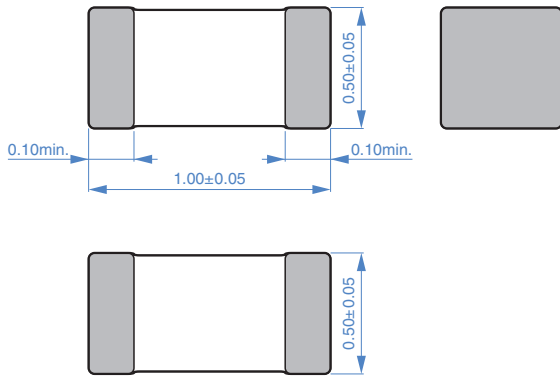

Dimensions in mm

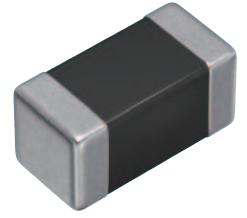

RECOMMENDED LAND PATTERN

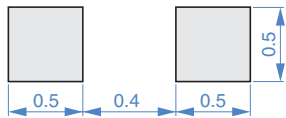

Dimensions in mm

MAF1005G type

ELECTRICAL CHARACTERISTICS

CHARACTERISTICS SPECIFICATION TABLE

Type	Impedance				DC resistance		Rated current (mA)max.	Part No.
	[100MHz] (Ω)Typ.	[900MHz] (Ω)Typ.	(Ω)Min.	[1.7GHz] (Ω)Typ.	(Ω)Typ.	(Ω)max.		
Wide-band	40	250	150	320	0.110	0.150	1250*	MAF1005GAD251DT000
	60	400	240	490	0.160	0.210	1000*	MAF1005GAD401DT000
Low resistance	80	570	340	630	0.200	0.270	900*	MAF1005GAD571DT000
	105	700	450	750	0.270	0.351	800*	MAF1005GAD701DT000
Wide-band	135	1000	650	750	0.420	0.550	450	MAF1005GAD102AT000
	200	1500	1000	1200	0.550	0.700	400	MAF1005GAD152AT000
	400	2600	1750	2000	1.000	1.200	300	MAF1005GAD262AT000
	500	3500	2500	2400	1.300	1.650	270	MAF1005GAD352AT000

* Please refer to the graph of rated current vs. temperature characteristics (derating) about the rating current at 85°C or more in temperature of the product.

Measurement equipment

Measurement item	Product No.	Manufacturer
Impedance	E4991A+16192A	Keysight Technologies
DC resistance	Type-7556	Yokogawa

* Equivalent measurement equipment may be used.

Rated current vs. temperature characteristics (derating)

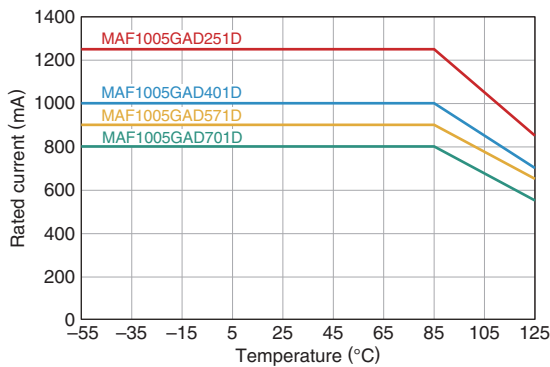

MAF1005G type (Wide-band, low resistance type)

ELECTRICAL CHARACTERISTICS

Z FREQUENCY CHARACTERISTICS

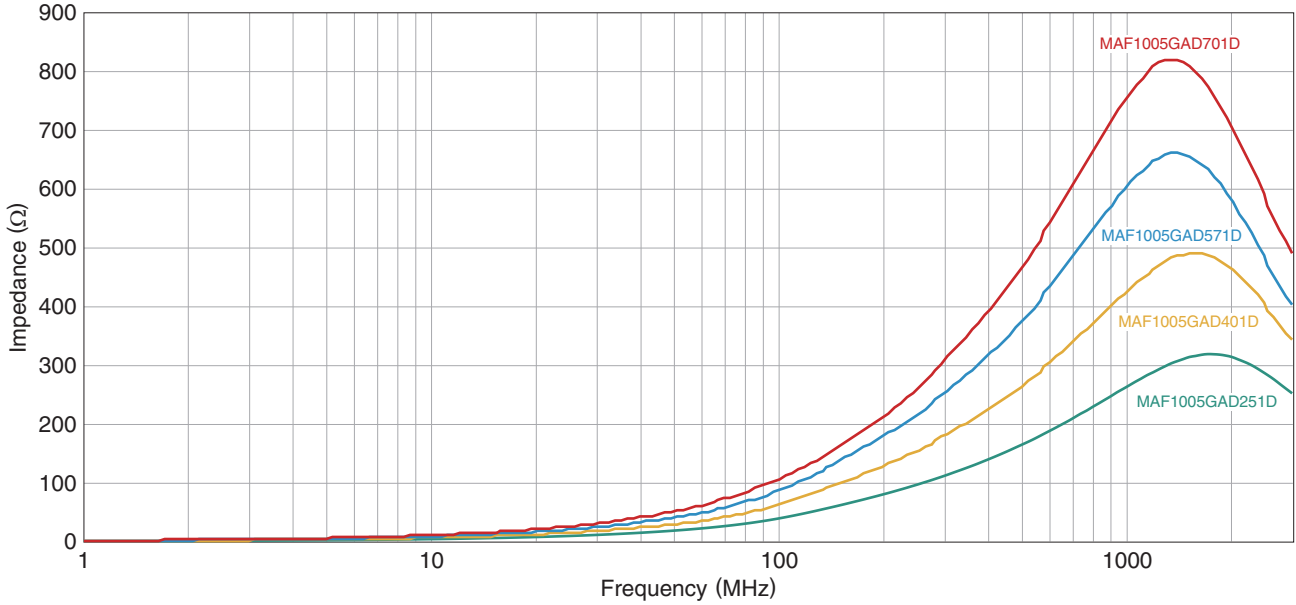

INSERTION LOSS VS. FREQUENCY CHARACTERISTICS

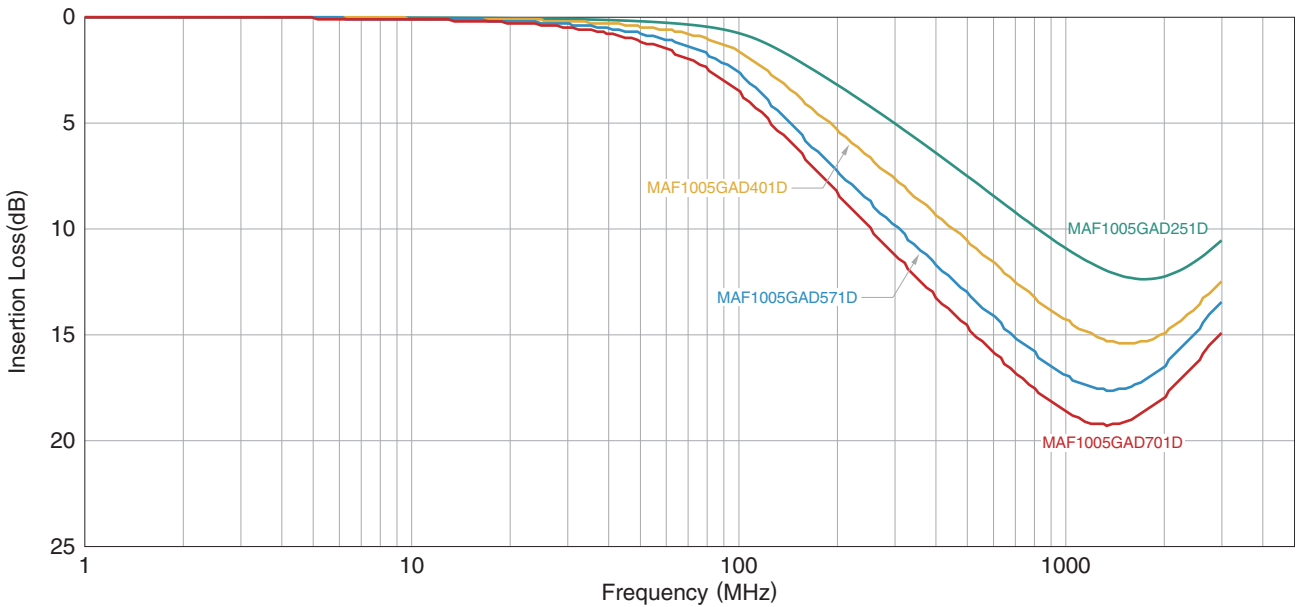

 Please be sure to request delivery specifications that provide further details on the features and specifications of the products for proper and safe use. Please note that the contents may change without any prior notice due to reasons such as upgrading.

MAF1005G type (Wide-band type)

ELECTRICAL CHARACTERISTICS

Z FREQUENCY CHARACTERISTICS

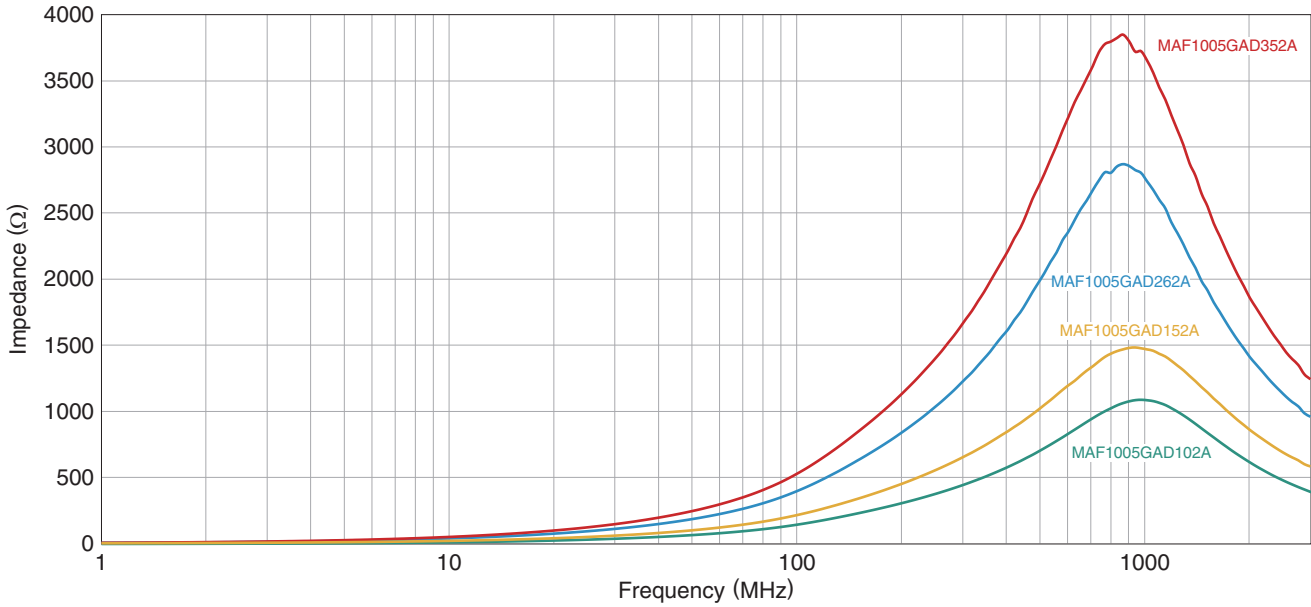

INSERTION LOSS VS. FREQUENCY CHARACTERISTICS

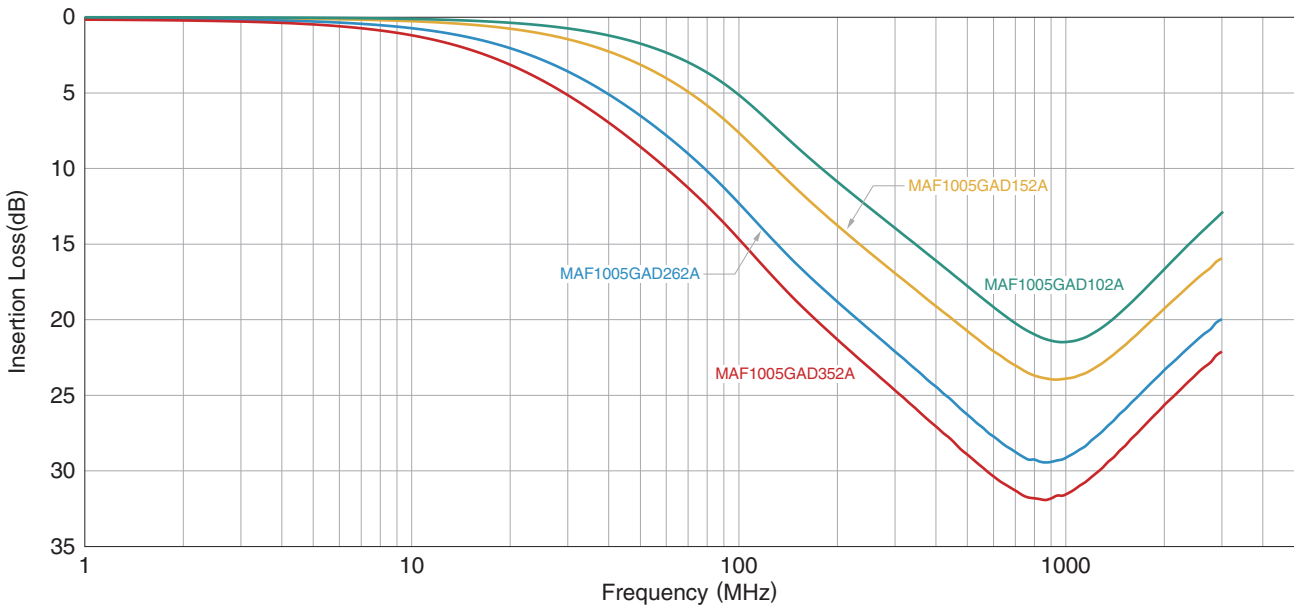

 Please be sure to request delivery specifications that provide further details on the features and specifications of the products for proper and safe use. Please note that the contents may change without any prior notice due to reasons such as upgrading.

MAF1005G type

PACKAGING STYLE

REEL DIMENSIONS

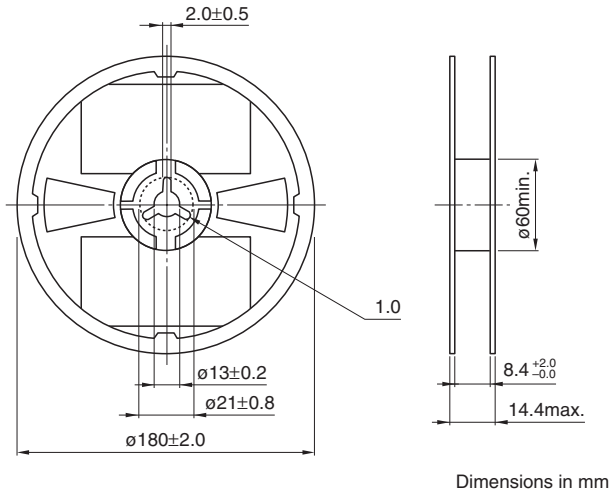

TAPE DIMENSIONS

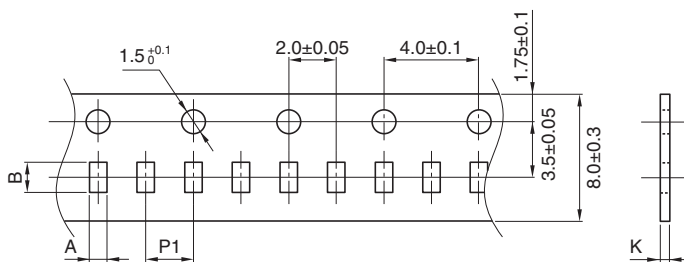

Type	A	B	P1	K
MAF1005G	0.65 ± 0.1	1.15 ± 0.1	2.0 ± 0.05	0.8 max.

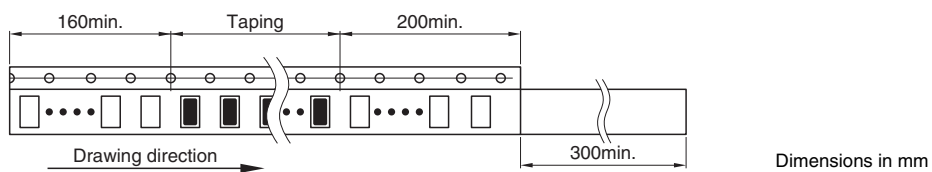

⚠ Please be sure to request delivery specifications that provide further details on the features and specifications of the products for proper and safe use.
Please note that the contents may change without any prior notice due to reasons such as upgrading.