

FEATURES

- **Low Noise Voltage: 1.9nV/ $\sqrt{\text{Hz}}$**
- **Low Supply Current: 1.2mA/Amp Max**
- **Low Offset Voltage: 350 μV Max**
- **Gain-Bandwidth Product:**
 - LT6233: 60MHz; $A_V \geq 1$
 - LT6233-10: 375MHz; $A_V \geq 10$
- **Wide Supply Range: 3V to 12.6V**
- **Output Swings Rail-to-Rail**
- **Common Mode Rejection Ratio: 115dB Typ**
- **Output Current: 30mA**
- **Operating Temperature Range: -40°C to 85°C**
- **LT6233 Shutdown to 10 μA Maximum**
- **LT6233/LT6233-10 in a Low Profile (1mm) ThinSOT™ Package**
- **Dual LT6234 in 8-Pin SO and Tiny DFN Packages**
- **LT6235 in a 16-Pin SSOP Package**

APPLICATIONS

- Ultrasound Amplifiers
- Low Noise, Low Power Signal Processing
- Active Filters
- Driving A/D Converters
- Rail-to-Rail Buffer Amplifiers

DESCRIPTION

The LT[®]6233/LT6234/LT6235 are single/dual/quad low noise, rail-to-rail output unity-gain stable op amps that feature 1.9nV/ $\sqrt{\text{Hz}}$ noise voltage and draw only 1.2mA of supply current per amplifier. These amplifiers combine very low noise and supply current with a 60MHz gain-bandwidth product, a 17V/ μs slew rate and are optimized for low supply voltage signal conditioning systems. The LT6233-10 is a single amplifier optimized for higher gain applications resulting in higher gain bandwidth and slew rate. The LT6233 and LT6233-10 include an enable pin that can be used to reduce the supply current to less than 10 μA .

The amplifier family has an output that swings within 50mV of either supply rail to maximize the signal dynamic range in low supply applications and is specified on 3.3V, 5V and $\pm 5\text{V}$ supplies. The $e_n \cdot \sqrt{I_{\text{SUPPLY}}}$ product of 2.1 per amplifier is among the most noise efficient of any op amp.

The LT6233/LT6233-10 are available in the 6-lead SOT-23 package and the LT6234 dual is available in the 8-pin SO package with standard pinouts. For compact layouts, the dual is also available in a tiny dual fine pitch leadless package (DFN). The LT6235 is available in the 16-pin SSOP package.

LT, LT, LTC, LTM, Linear Technology and the Linear logo are registered trademarks of Linear Technology Corporation. ThinSOT is a trademark of Linear Technology Corporation. All other trademarks are the property of their respective owners.

TYPICAL APPLICATION

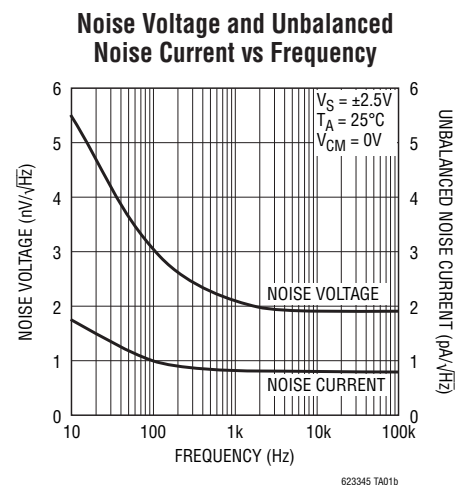
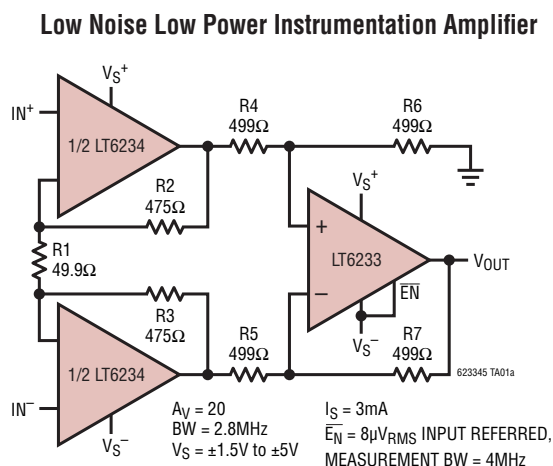

623345fc

LT6233/LT6233-10 LT6234/LT6235

ABSOLUTE MAXIMUM RATINGS (Note 1)

| | | | |
|---|---------------|--|----------------|
| Total Supply Voltage (V^+ to V^-) | 12.6V | Junction Temperature (DD Package)..... | 125°C |
| Input Current (Note 2)..... | +40mA | Storage Temperature Range | -65°C to 150°C |
| Output Short-Circuit Duration (Note 3) | Indefinite | Storage Temperature Range (DD Package)..... | -65°C to 125°C |
| Operating Temperature Range (Note 4).... | -40°C to 85°C | Lead Temperature (Soldering, 10 sec)..... | 300°C |
| Specified Temperature Range (Note 5) | -40°C to 85°C | | |
| Junction Temperature | 150°C | | |

PIN CONFIGURATION

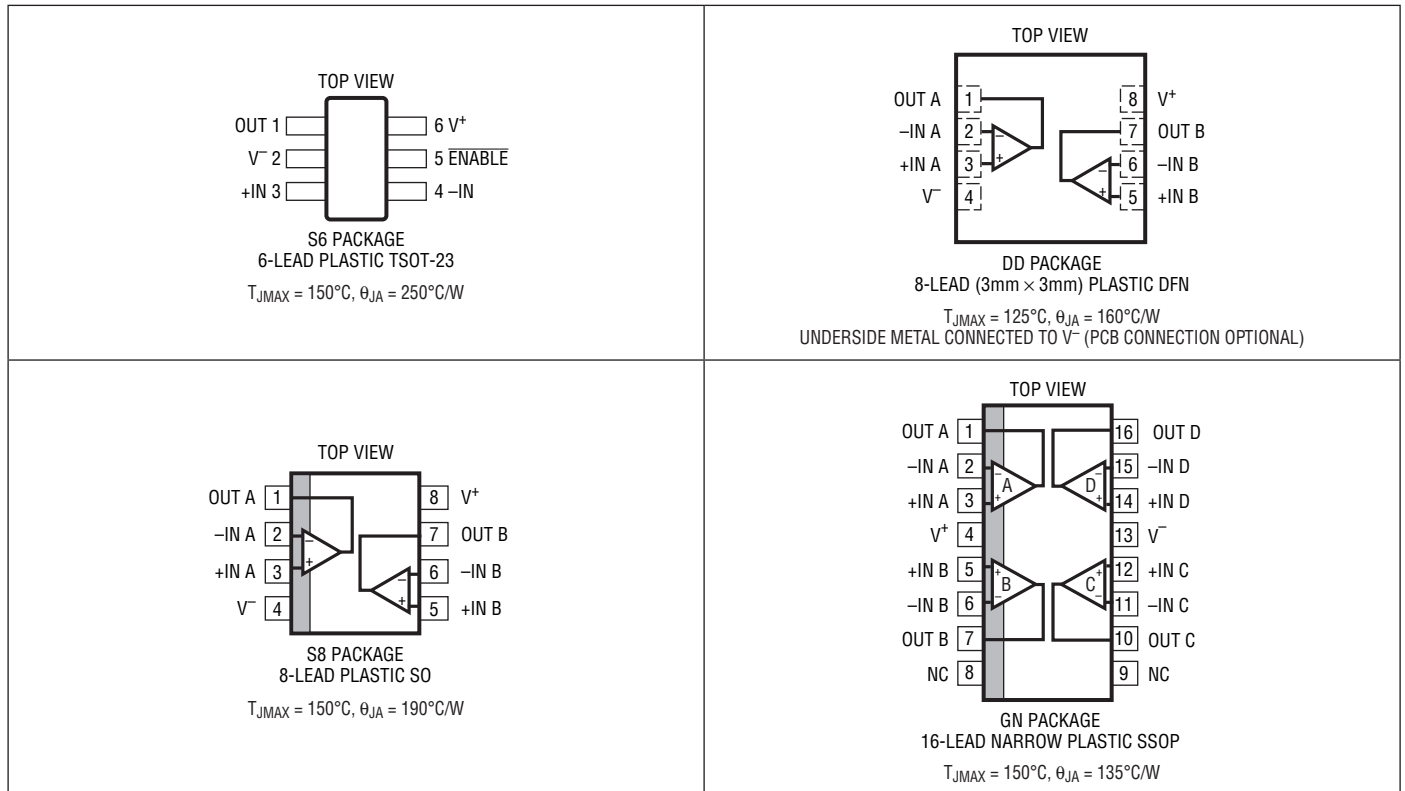

ORDER INFORMATION

| LEAD FREE FINISH | TAPE AND REEL | PART MARKING* | PACKAGE DESCRIPTION | SPECIFIED TEMPERATURE RANGE |
|------------------|--------------------|---------------|--------------------------------|-----------------------------|
| LT6233CS6#PBF | LT6233CS6#TRPBF | LTAFL | 6-Lead Plastic TSOT-23 | 0°C to 70°C |
| LT6233IS6#PBF | LT6233IS6#TRPBF | LTAFL | 6-Lead Plastic TSOT-23 | -40°C to 85°C |
| LT6233CS6-10#PBF | LT6233CS6-10#TRPBF | LTAFM | 6-Lead Plastic TSOT-23 | 0°C to 70°C |
| LT6233IS6-10#PBF | LT6233IS6-10#TRPBF | LTAFM | 6-Lead Plastic TSOT-23 | -40°C to 85°C |
| LT6234CS8#PBF | LT6234CS8#TRPBF | 6234 | 8-Lead Plastic SO | 0°C to 70°C |
| LT6234IS8#PBF | LT6234IS8#TRPBF | 6234I | 8-Lead Plastic SO | -40°C to 85°C |
| LT6234CDD#PBF | LT6234CDD#TRPBF | LAET | 8-Lead (3mm × 3mm) Plastic DFN | 0°C to 70°C |
| LT6234IDD#PBF | LT6234IDD#TRPBF | LAET | 8-Lead (3mm × 3mm) Plastic DFN | -40°C to 85°C |
| LT6235CGN#PBF | LT6235CGN#TRPBF | 6235 | 16-Lead Narrow Plastic SSOP | 0°C to 70°C |
| LT6235IGN#PBF | LT6235IGN#TRPBF | 6235I | 16-Lead Narrow Plastic SSOP | -40°C to 85°C |

Consult LTC Marketing for parts specified with wider operating temperature ranges. *The temperature grade is identified by a label on the shipping container. Consult LTC Marketing for information on non-standard lead based finish parts.

For more information on lead free part marking, go to: <http://www.linear.com/leadfree/>

For more information on tape and reel specifications, go to: <http://www.linear.com/tapeandreel/>

ELECTRICAL CHARACTERISTICS $T_A = 25^\circ\text{C}$, $V_S = 5\text{V}$, 0V ; $V_S = 3.3\text{V}$, 0V ; $V_{CM} = V_{OUT} = \text{half supply}$, ENABLE = 0V, unless otherwise noted.

| SYMBOL | PARAMETER | CONDITIONS | MIN | TYP | MAX | UNITS |
|-----------|--|---|----------|-----------|------------|------------------------|
| V_{OS} | Input Offset Voltage | LT6233S6, LT6233S6-10 | | 100 | 500 | μV |
| | | LT6234S8, LT6235GN LT6234DD | | 50 75 | 350 450 | μV |
| | Input Offset Voltage Match (Channel-to-Channel) (Note 6) | | | 80 | 600 | μV |
| I_B | Input Bias Current | | | 1.5 | 3 | μA |
| | | I_B Match (Channel-to-Channel) (Note 6) | | 0.04 | 0.3 | μA |
| I_{OS} | Input Offset Current | | | 0.04 | 0.3 | μA |
| | Input Noise Voltage | 0.1Hz to 10Hz | | 220 | | nV _{p-p} |
| e_n | Input Noise Voltage Density | $f = 10\text{kHz}$, $V_S = 5\text{V}$ | | 1.9 | 3 | nV/ $\sqrt{\text{Hz}}$ |
| i_n | Input Noise Current Density, Balanced Source Input Noise Current Density, Unbalanced Source | $f = 10\text{kHz}$, $V_S = 5\text{V}$, $R_S = 10\text{k}$ | | 0.43 | | pA/ $\sqrt{\text{Hz}}$ |
| | | $f = 10\text{kHz}$, $V_S = 5\text{V}$, $R_S = 10\text{k}$ | | 0.78 | | pA/ $\sqrt{\text{Hz}}$ |
| | Input Resistance | Common Mode | | 22 | | M Ω |
| | | Differential Mode | | 25 | | k Ω |
| C_{IN} | Input Capacitance | Common Mode | | 2.5 | | pF |
| | | Differential Mode | | 4.2 | | pF |
| A_{VOL} | Large-Signal Gain | $V_S = 5\text{V}$, $V_O = 0.5\text{V}$ to 4.5V , $R_L = 10\text{k}$ to $V_S/2$ | 73 | 140 | | V/mV |
| | | $V_S = 5\text{V}$, $V_O = 0.5\text{V}$ to 4.5V , $R_L = 1\text{k}$ to $V_S/2$ | 18 | 35 | | V/mV |
| | | $V_S = 3.3\text{V}$, $V_O = 0.65\text{V}$ to 2.65V , $R_L = 10\text{k}$ to $V_S/2$ $V_S = 3.3\text{V}$, $V_O = 0.65\text{V}$ to 2.65V , $R_L = 1\text{k}$ to $V_S/2$ | 53 11 | 100 20 | | V/mV V/mV |
| V_{CM} | Input Voltage Range | Guaranteed by CMRR, $V_S = 5\text{V}$, 0V | 1.5 | | 4 | V |
| | | Guaranteed by CMRR, $V_S = 3.3\text{V}$, 0V | 1.15 | | 2.65 | V |
| CMRR | Common Mode Rejection Ratio | $V_S = 5\text{V}$, $V_{CM} = 1.5\text{V}$ to 4V | 90 | 115 | | dB |
| | | $V_S = 3.3\text{V}$, $V_{CM} = 1.15\text{V}$ to 2.65V | 85 | 110 | | dB |
| | CMRR Match (Channel-to-Channel) (Note 6) | $V_S = 5\text{V}$, $V_{CM} = 1.5\text{V}$ to 4V | 84 | 115 | | dB |

LT6233/LT6233-10

LT6234/LT6235

ELECTRICAL CHARACTERISTICS

$T_A = 25^\circ\text{C}$, $V_S = 5\text{V}$, 0V ; $V_S = 3.3\text{V}$, 0V ; $V_{\text{CM}} = V_{\text{OUT}} = \text{half supply}$,
ENABLE = 0V, unless otherwise noted.

| SYMBOL | PARAMETER | CONDITIONS | MIN | TYP | MAX | UNITS |
|---------------------|--|---|--------------|----------|-----|------------------------|
| PSRR | Power Supply Rejection Ratio | $V_S = 3\text{V to } 10\text{V}$ | 90 | 115 | | dB |
| | PSRR Match (Channel-to-Channel) (Note 6) | $V_S = 3\text{V to } 10\text{V}$ | 84 | 115 | | dB |
| | Minimum Supply Voltage (Note 7) | | 3 | | | V |
| V_{OL} | Output Voltage Swing Low (Note 8) | No Load | | 4 | 40 | mV |
| | | $I_{\text{SINK}} = 5\text{mA}$ | | 75 | 180 | mV |
| | | $V_S = 5\text{V}$, $I_{\text{SINK}} = 15\text{mA}$ | | 165 | 320 | mV |
| | | $V_S = 3.3\text{V}$, $I_{\text{SINK}} = 10\text{mA}$ | | 125 | 240 | mV |
| V_{OH} | Output Voltage Swing High (Note 8) | No Load | | 5 | 50 | mV |
| | | $I_{\text{SOURCE}} = 5\text{mA}$ | | 85 | 195 | mV |
| | | $V_S = 5\text{V}$, $I_{\text{SOURCE}} = 15\text{mA}$ | | 220 | 410 | mV |
| | | $V_S = 3.3\text{V}$, $I_{\text{SOURCE}} = 10\text{mA}$ | | 165 | 310 | mV |
| I_{SC} | Short-Circuit Current | $V_S = 5\text{V}$ | ± 40 | ± 55 | | mA |
| | | $V_S = 3.3\text{V}$ | ± 35 | ± 50 | | mA |
| I_S | Supply Current per Amplifier | | | 1.05 | 1.2 | mA |
| | Disabled Supply Current per Amplifier | ENABLE = $V^+ - 0.35\text{V}$ | | 0.2 | 10 | μA |
| I_{ENABLE} | ENABLE Pin Current | ENABLE = 0.3V | | -25 | -75 | μA |
| V_L | ENABLE Pin Input Voltage Low | | | | 0.3 | V |
| V_H | ENABLE Pin Input Voltage High | | $V^+ - 0.35$ | | | V |
| | Output Leakage Current | ENABLE = $V^+ - 0.35\text{V}$, $V_O = 1.5\text{V to } 3.5\text{V}$ | | 0.2 | 10 | μA |
| t_{ON} | Turn-On Time | ENABLE = $5\text{V to } 0\text{V}$, $R_L = 1\text{k}$, $V_S = 5\text{V}$ | | 500 | | ns |
| t_{OFF} | Turn-Off Time | ENABLE = $0\text{V to } 5\text{V}$, $R_L = 1\text{k}$, $V_S = 5\text{V}$ | | 76 | | μs |
| GBW | Gain-Bandwidth Product | Frequency = 1MHz , $V_S = 5\text{V}$ | | 55 | | MHz |
| | | LT6233-10 | | 320 | | MHz |
| SR | Slew Rate | $V_S = 5\text{V}$, $A_V = -1$, $R_L = 1\text{k}$, $V_O = 1.5\text{V to } 3.5\text{V}$ | 10 | 15 | | $\text{V}/\mu\text{s}$ |
| | | LT6233-10, $V_S = 5\text{V}$, $A_V = -10$, $R_L = 1\text{k}$, $V_O = 1.5\text{V to } 3.5\text{V}$ | | 80 | | $\text{V}/\mu\text{s}$ |
| FPBW | Full-Power Bandwidth | $V_S = 5\text{V}$, $V_{\text{OUT}} = 3V_{\text{P-P}}$ (Note 9) | 1.06 | 1.6 | | MHz |
| | | LT6233-10, $\text{HD}_2 = \text{HD}_3 \leq 1\%$ | | 2.2 | | MHz |
| t_S | Settling Time (LT6233, LT6234, LT6235) | 0.1% , $V_S = 5\text{V}$, $V_{\text{STEP}} = 2\text{V}$, $A_V = -1$, $R_L = 1\text{k}$ | | 175 | | ns |

ELECTRICAL CHARACTERISTICS The ● denotes the specifications which apply over the $0^{\circ}\text{C} < T_A < 70^{\circ}\text{C}$ temperature range. $V_S = 5\text{V}, 0\text{V}$; $V_S = 3.3\text{V}, 0\text{V}$; $V_{CM} = V_{OUT} = \text{half supply}$, $\overline{\text{ENABLE}} = 0\text{V}$, unless otherwise noted.

| SYMBOL | PARAMETER | CONDITIONS | MIN | TYP | MAX | UNIT |
|--------------------------------|--|--|-----|--------------|-----------|--------------------------------|
| V_{OS} | Input Offset Voltage | LT6233CS6, LT6233CS6-10 | ● | | 600 | μV |
| | | LT6234CS8, LT6235CGN | ● | | 450 | μV |
| | | LT6234CDD | ● | | 550 | μV |
| | Input Offset Voltage Match (Channel-to-Channel) (Note 6) | | ● | | 800 | μV |
| $V_{OS\ TC}$ | Input Offset Voltage Drift (Note 10) | $V_{CM} = \text{Half Supply}$ | ● | 0.5 | 3.0 | $\mu\text{V}/^{\circ}\text{C}$ |
| I_B | Input Bias Current | | ● | | 3.5 | μA |
| | I_B Match (Channel-to-Channel) (Note 6) | | ● | | 0.4 | μA |
| I_{OS} | Input Offset Current | | ● | | 0.4 | μA |
| A_{VOL} | Large-Signal Gain | $V_S = 5\text{V}, V_O = 0.5\text{V to } 4.5\text{V}, R_L = 10\text{k to } V_S/2$ | ● | 47 | | V/mV |
| | | $V_S = 5\text{V}, V_O = 0.5\text{V to } 4.5\text{V}, R_L = 1\text{k to } V_S/2$ | ● | 12 | | V/mV |
| | | $V_S = 3.3\text{V}, V_O = 0.65\text{V to } 2.65\text{V}, R_L = 10\text{k to } V_S/2$ | ● | 40 | | V/mV |
| | | $V_S = 3.3\text{V}, V_O = 0.65\text{V to } 2.65\text{V}, R_L = 1\text{k to } V_S/2$ | ● | 7.5 | | V/mV |
| V_{CM} | Input Voltage Range | Guaranteed by CMRR | ● | | | |
| | | $V_S = 5\text{V}, 0\text{V}$ $V_S = 3.3\text{V}, 0\text{V}$ | ● | 1.5 1.15 | 4 2.65 | V V |
| CMRR | Common Mode Rejection Ratio | $V_S = 5\text{V}, V_{CM} = 1.5\text{V to } 4\text{V}$ $V_S = 3.3\text{V}, V_{CM} = 1.15\text{V to } 2.65\text{V}$ | ● | 90 | | dB |
| | CMRR Match (Channel-to-Channel) (Note 6) | $V_S = 5\text{V}, V_{CM} = 1.5\text{V to } 4\text{V}$ | ● | 85 | | dB |
| PSRR | Power Supply Rejection Ratio | $V_S = 3\text{V to } 10\text{V}$ | ● | 90 | | dB |
| | PSRR Match (Channel-to-Channel) (Note 6) | $V_S = 3\text{V to } 10\text{V}$ | ● | 84 | | dB |
| | Minimum Supply Voltage (Note 7) | | ● | 3 | | V |
| V_{OL} | Output Voltage Swing Low (Note 8) | No Load | ● | | 50 | mV |
| | | $I_{SINK} = 5\text{mA}$ | ● | | 195 | mV |
| | | $V_S = 5\text{V}, I_{SINK} = 15\text{mA}$ | ● | | 360 | mV |
| | | $V_S = 3.3\text{V}, I_{SINK} = 10\text{mA}$ | ● | | 265 | mV |
| V_{OH} | Output Voltage Swing High (Note 8) | No Load | ● | | 60 | mV |
| | | $I_{SOURCE} = 5\text{mA}$ | ● | | 205 | mV |
| | | $V_S = 5\text{V}, I_{SOURCE} = 15\text{mA}$ | ● | | 435 | mV |
| | | $V_S = 3.3\text{V}, I_{SOURCE} = 10\text{mA}$ | ● | | 330 | mV |
| I_{SC} | Short-Circuit Current | $V_S = 5\text{V}$ | ● | ± 35 | | mA |
| | | $V_S = 3.3\text{V}$ | ● | ± 30 | | mA |
| I_S | Supply Current per Amplifier | | ● | | 1.45 | mA |
| | Disabled Supply Current per Amplifier | $\overline{\text{ENABLE}} = V^+ - 0.25\text{V}$ | ● | 1 | | μA |
| $I_{\overline{\text{ENABLE}}}$ | ENABLE Pin Current | $\overline{\text{ENABLE}} = 0.3\text{V}$ | ● | | -85 | μA |
| V_L | ENABLE Pin Input Voltage Low | | ● | | 0.3 | V |
| V_H | ENABLE Pin Input Voltage High | | ● | $V^+ - 0.25$ | | V |
| | Output Leakage Current | $\overline{\text{ENABLE}} = V^+ - 0.25\text{V}, V_O = 1.5\text{V to } 3.5\text{V}$ | ● | 1 | | μA |
| t_{ON} | Turn-On Time | $\overline{\text{ENABLE}} = 5\text{V to } 0\text{V}, R_L = 1\text{k}, V_S = 5\text{V}$ | ● | 500 | | ns |
| t_{OFF} | Turn-Off Time | $\overline{\text{ENABLE}} = 0\text{V to } 5\text{V}, R_L = 1\text{k}, V_S = 5\text{V}$ | ● | 120 | | μs |
| SR | Slew Rate | $V_S = 5\text{V}, A_V = -1, R_L = 1\text{k}, V_O = 1.5\text{V to } 3.5\text{V}$ | ● | 9 | | $\text{V}/\mu\text{s}$ |
| | | LT6233-10, $A_V = -10, R_L = 1\text{k}, V_O = 1.5\text{V to } 3.5\text{V}$ | ● | 75 | | $\text{V}/\mu\text{s}$ |
| FPBW | Full-Power Bandwidth (Note 9) | $V_S = 5\text{V}, V_{OUT} = 3V_{P-P}$; LT6233C, LT6234C, LT6235C | ● | 955 | | kHz |

LT6233/LT6233-10

LT6234/LT6235

ELECTRICAL CHARACTERISTICS The ● denotes the specifications which apply over the $-40^{\circ}\text{C} < T_A < 85^{\circ}\text{C}$ temperature range. $V_S = 5\text{V}, 0\text{V}$; $V_S = 3.3\text{V}, 0\text{V}$; $V_{\text{CM}} = V_{\text{OUT}} = \text{half supply}$, $\overline{\text{ENABLE}} = 0\text{V}$, unless otherwise noted. (Note 5)

| SYMBOL | PARAMETER | CONDITIONS | MIN | TYP | MAX | UNITS |
|---------------------|--|--|-----|-------------|-----------|--------------------------------|
| V_{OS} | Input Offset Voltage | LT6233IS6, LT6233IS6-10 | ● | | 700 | μV |
| | | LT6234IS8, LT6235IGN | ● | | 550 | μV |
| | | LT6234IDD | ● | | 650 | μV |
| | Input Offset Voltage Match (Channel-to-Channel) (Note 6) | | ● | | 1000 | μV |
| $V_{\text{OS TC}}$ | Input Offset Voltage Drift (Note 10) | $V_{\text{CM}} = \text{Half Supply}$ | ● | 0.5 | 3 | $\mu\text{V}/^{\circ}\text{C}$ |
| I_{B} | Input Bias Current | | ● | | 4 | μA |
| | I_{B} Match (Channel-to-Channel) (Note 6) | | ● | | 0.4 | μA |
| I_{OS} | Input Offset Current | | ● | | 0.5 | μA |
| A_{VOL} | Large-Signal Gain | $V_S = 5\text{V}, V_0 = 0.5\text{V to } 4.5\text{V}, R_L = 10\text{k to } V_S/2$ | ● | 45 | | V/mV |
| | | $V_S = 5\text{V}, V_0 = 0.5\text{V to } 4.5\text{V}, R_L = 1\text{k to } V_S/2$ | ● | 11 | | V/mV |
| | | $V_S = 3.3\text{V}, V_0 = 0.65\text{V to } 2.65\text{V}, R_L = 10\text{k to } V_S/2$ | ● | 38 | | V/mV |
| | | $V_S = 3.3\text{V}, V_0 = 0.65\text{V to } 2.65\text{V}, R_L = 1\text{k to } V_S/2$ | ● | 7 | | V/mV |
| V_{CM} | Input Voltage Range | Guaranteed by CMRR | ● | | | V |
| | | $V_S = 5\text{V}, 0\text{V}$ $V_S = 3.3\text{V}, 0\text{V}$ | ● | 1.5 1.15 | 4 2.65 | V |
| CMRR | Common Mode Rejection Ratio | $V_S = 5\text{V}, V_{\text{CM}} = 1.5\text{V to } 4\text{V}$ $V_S = 3.3\text{V}, V_{\text{CM}} = 1.15\text{V to } 2.65\text{V}$ | ● | 90 | | dB |
| | CMRR Match (Channel-to-Channel) (Note 6) | $V_S = 5\text{V}, V_{\text{CM}} = 1.5\text{V to } 4\text{V}$ | ● | 85 | | dB |
| | CMRR Match (Channel-to-Channel) (Note 6) | $V_S = 5\text{V}, V_{\text{CM}} = 1.5\text{V to } 4\text{V}$ | ● | 84 | | dB |
| PSRR | Power Supply Rejection Ratio | $V_S = 3\text{V to } 10\text{V}$ | ● | 90 | | dB |
| | PSRR Match (Channel-to-Channel) (Note 6) | $V_S = 3\text{V to } 10\text{V}$ | ● | 84 | | dB |
| | Minimum Supply Voltage (Note 7) | | ● | 3 | | V |
| V_{OL} | Output Voltage Swing Low (Note 8) | No Load | ● | | 50 | mV |
| | | $I_{\text{SINK}} = 5\text{mA}$ | ● | | 195 | mV |
| | | $V_S = 5\text{V}, I_{\text{SINK}} = 15\text{mA}$ | ● | | 370 | mV |
| | | $V_S = 3.3\text{V}, I_{\text{SINK}} = 10\text{mA}$ | ● | | 275 | mV |
| V_{OH} | Output Voltage Swing High (Note 6) | No Load | ● | | 60 | mV |
| | | $I_{\text{SOURCE}} = 5\text{mA}$ | ● | | 210 | mV |
| | | $V_S = 5\text{V}, I_{\text{SOURCE}} = 15\text{mA}$ | ● | | 445 | mV |
| | | $V_S = 3.3\text{V}, I_{\text{SOURCE}} = 10\text{mA}$ | ● | | 335 | mV |
| I_{SC} | Short-Circuit Current | $V_S = 5\text{V}$ | ● | ± 30 | | mA |
| | | $V_S = 3.3\text{V}$ | ● | ± 20 | | mA |
| I_{S} | Supply Current per Amplifier | | ● | | 1.5 | mA |
| | Disabled Supply Current per Amplifier | $\overline{\text{ENABLE}} = V^+ - 0.2\text{V}$ | ● | 1 | | μA |
| I_{ENABLE} | ENABLE Pin Current | $\overline{\text{ENABLE}} = 0.3\text{V}$ | ● | | -100 | μA |
| V_{L} | ENABLE Pin Input Voltage Low | | ● | | 0.3 | V |
| V_{H} | ENABLE Pin Input Voltage High | | ● | $V^+ - 0.2$ | | V |
| | Output Leakage Current | $\overline{\text{ENABLE}} = V^+ - 0.2\text{V}, V_0 = 1.5\text{V to } 3.5\text{V}$ | ● | 1 | | μA |
| t_{ON} | Turn-On Time | $\overline{\text{ENABLE}} = 5\text{V to } 0\text{V}, R_L = 1\text{k}, V_S = 5\text{V}$ | ● | 500 | | ns |
| t_{OFF} | Turn-Off Time | $\overline{\text{ENABLE}} = 0\text{V to } 5\text{V}, R_L = 1\text{k}, V_S = 5\text{V}$ | ● | 135 | | μs |
| SR | Slew Rate | $V_S = 5\text{V}, A_V = -1, R_L = 1\text{k}, V_0 = 1.5\text{V to } 3.5\text{V}$ | ● | 8 | | $\text{V}/\mu\text{s}$ |
| | | LT6233-10, $A_V = -10, R_L = 1\text{k}, V_0 = 1.5\text{V to } 3.5\text{V}$ | ● | 70 | | $\text{V}/\mu\text{s}$ |
| FPBW | Full-Power Bandwidth (Note 9) | $V_S = 5\text{V}, V_{\text{OUT}} = 3\text{V}_{\text{P-P}}$; LT6233I, LT6234I, LT6235I | ● | 848 | | kHz |

ELECTRICAL CHARACTERISTICS $T_A = 25^\circ\text{C}$, $V_S = \pm 5\text{V}$, $V_{\text{CM}} = V_{\text{OUT}} = 0\text{V}$, $\overline{\text{ENABLE}} = 0\text{V}$, unless otherwise noted.

| SYMBOL | PARAMETER | CONDITIONS | MIN | TYP | MAX | UNITS |
|---------------------|--|---|----------|----------|-----|------------------------------|
| V_{OS} | Input Offset Voltage | LT6233S6, LT6233S6-10 | | 100 | 500 | μV |
| | | LT6234S8, LT6235GN | | 50 | 350 | μV |
| | | LT6234DD | | 75 | 450 | μV |
| | Input Offset Voltage Match (Channel-to-Channel) (Note 6) | | | 100 | 600 | μV |
| I_{B} | Input Bias Current | | | 1.5 | 3 | μA |
| | I_{B} Match (Channel-to-Channel) (Note 6) | | | 0.04 | 0.3 | μA |
| I_{OS} | Input Offset Current | | | 0.04 | 0.3 | μA |
| | Input Noise Voltage | 0.1Hz to 10Hz | | 220 | | $\text{nV}_{\text{p-p}}$ |
| e_{n} | Input Noise Voltage Density | $f = 10\text{kHz}$ | | 1.9 | 3.0 | $\text{nV}/\sqrt{\text{Hz}}$ |
| i_{n} | Input Noise Current Density, Balanced Source | $f = 10\text{kHz}$, $R_{\text{S}} = 10\text{k}$ | | 0.43 | | $\text{pA}/\sqrt{\text{Hz}}$ |
| | Input Noise Current Density, Unbalanced Source | $f = 10\text{kHz}$, $R_{\text{S}} = 10\text{k}$ | | 0.78 | | $\text{pA}/\sqrt{\text{Hz}}$ |
| | Input Resistance | Common Mode | | 22 | | $\text{M}\Omega$ |
| | | Differential Mode | | 25 | | $\text{k}\Omega$ |
| C_{IN} | Input Capacitance | Common Mode | | 2.1 | | pF |
| | | Differential Mode | | 3.7 | | pF |
| A_{VOL} | Large-Signal Gain | $V_{\text{O}} = \pm 4.5\text{V}$, $R_{\text{L}} = 10\text{k}$ | 97 | 180 | | V/mV |
| | | $V_{\text{O}} = \pm 4.5\text{V}$, $R_{\text{L}} = 1\text{k}$ | 28 | 55 | | V/mV |
| V_{CM} | Input Voltage Range | Guaranteed by CMRR | -3 | | 4 | V |
| CMRR | Common Mode Rejection Ratio | $V_{\text{CM}} = -3\text{V}$ to 4V | 90 | 110 | | dB |
| | CMRR Match (Channel-to-Channel) (Note 6) | $V_{\text{CM}} = -3\text{V}$ to 4V | 84 | 120 | | dB |
| PSRR | Power Supply Rejection Ratio | $V_{\text{S}} = \pm 1.5\text{V}$ to $\pm 5\text{V}$ | 90 | 115 | | dB |
| | PSRR Match (Channel-to-Channel) (Note 6) | $V_{\text{S}} = \pm 1.5\text{V}$ to $\pm 5\text{V}$ | 84 | 115 | | dB |
| V_{OL} | Output Voltage Swing Low (Note 8) | No Load | | 4 | 40 | mV |
| | | $I_{\text{SINK}} = 5\text{mA}$ | | 75 | 180 | mV |
| | | $I_{\text{SINK}} = 15\text{mA}$ | | 165 | 320 | mV |
| V_{OH} | Output Voltage Swing High (Note 8) | No Load | | 5 | 50 | mV |
| | | $I_{\text{SOURCE}} = 5\text{mA}$ | | 85 | 195 | mV |
| | | $I_{\text{SOURCE}} = 15\text{mA}$ | | 220 | 410 | mV |
| I_{SC} | Short-Circuit Current | | ± 40 | ± 55 | | mA |
| I_{S} | Supply Current per Amplifier | | | 1.15 | 1.4 | mA |
| | Disabled Supply Current per Amplifier | $\overline{\text{ENABLE}} = 4.65\text{V}$ | | 0.2 | 10 | μA |
| I_{ENABLE} | ENABLE Pin Current | $\overline{\text{ENABLE}} = 0.3\text{V}$ | | -35 | -85 | μA |
| V_{L} | ENABLE Pin Input Voltage Low | | | | 0.3 | V |
| V_{H} | ENABLE Pin Input Voltage High | | 4.65 | | | V |
| | Output Leakage Current | $\overline{\text{ENABLE}} = 4.65\text{V}$, $V_{\text{O}} = \pm 1\text{V}$ | | 0.2 | 10 | μA |
| t_{ON} | Turn-On Time | $\overline{\text{ENABLE}} = 5\text{V}$ to 0V , $R_{\text{L}} = 1\text{k}$ | | 900 | | ns |
| t_{OFF} | Turn-Off Time | $\overline{\text{ENABLE}} = 0\text{V}$ to 5V , $R_{\text{L}} = 1\text{k}$ | | 100 | | μs |
| GBW | Gain-Bandwidth Product | Frequency = 1MHz | 42 | 60 | | MHz |
| | | LT6233-10 | 260 | 375 | | MHz |
| SR | Slew Rate | $A_{\text{V}} = -1$, $R_{\text{L}} = 1\text{k}$, $V_{\text{O}} = -2\text{V}$ to 2V | 12 | 17 | | $\text{V}/\mu\text{s}$ |
| | | LT6233-10, $A_{\text{V}} = -10$, $R_{\text{L}} = 1\text{k}$, $V_{\text{O}} = -2\text{V}$ to 2V | | 115 | | $\text{V}/\mu\text{s}$ |
| FPBW | Full-Power Bandwidth | $V_{\text{OUT}} = 3\text{V}_{\text{p-p}}$ (Note 9) | 1.27 | 1.8 | | MHz |
| | | LT6233-10, $\text{HD2} = \text{HD3} \leq 1\%$ | | 2.2 | | MHz |
| t_{S} | Settling Time (LT6233, LT6234, LT6235) | 0.1%, $V_{\text{STEP}} = 2\text{V}$, $A_{\text{V}} = -1$, $R_{\text{L}} = 1\text{k}$ | | 170 | | ns |

LT6233/LT6233-10

LT6234/LT6235

ELECTRICAL CHARACTERISTICS The ● denotes the specifications which apply over the $0^{\circ}\text{C} < T_A < 70^{\circ}\text{C}$ temperature range. $V_S = \pm 5\text{V}$, $V_{\text{CM}} = V_{\text{OUT}} = 0\text{V}$, $\overline{\text{ENABLE}} = 0\text{V}$, unless otherwise noted.

| SYMBOL | PARAMETER | CONDITIONS | | MIN | TYP | MAX | UNITS |
|--------------------------------|---|--|---|----------|-----|-----|--------------------------------|
| V_{OS} | Input Offset Voltage | LT6233CS6, LT6233CS6-10 | ● | | | 600 | μV |
| | | LT6234CS8, LT6235CGN | ● | | | 450 | μV |
| | | LT6234CDD | ● | | | 550 | μV |
| | Input Offset Voltage Match (Channel-to-Channel) (Note 6) | | ● | | | 800 | μV |
| $V_{\text{OS TC}}$ | Input Offset Voltage Drift (Note 10) | | ● | | 0.5 | 3 | $\mu\text{V}/^{\circ}\text{C}$ |
| I_{B} | Input Bias Current | | ● | | | 3.5 | μA |
| | I_{B} Match (Channel-to-Channel) (Note 6) | | ● | | | 0.4 | μA |
| I_{OS} | Input Offset Current | | ● | | | 0.4 | μA |
| A_{VOL} | Large-Signal Gain | $V_0 = \pm 4.5\text{V}$, $R_{\text{L}} = 10\text{k}$ | ● | 75 | | | V/mV |
| | | $V_0 = \pm 4.5\text{V}$, $R_{\text{L}} = 1\text{k}$ | ● | 22 | | | V/mV |
| V_{CM} | Input Voltage Range | Guaranteed by CMRR | ● | -3 | | 4 | V |
| CMRR | Common Mode Rejection Ratio | $V_{\text{CM}} = -3\text{V}$ to 4V | ● | 90 | | | dB |
| | CMRR Match (Channel-to-Channel) (Note 6) | $V_{\text{CM}} = -3\text{V}$ to 4V | ● | 84 | | | dB |
| PSRR | Power Supply Rejection Ratio | $V_{\text{S}} = \pm 1.5\text{V}$ to $\pm 5\text{V}$ | ● | 90 | | | dB |
| | PSRR Match (Channel-to-Channel) (Note 6) | $V_{\text{S}} = \pm 1.5\text{V}$ to $\pm 5\text{V}$ | ● | 84 | | | dB |
| V_{OL} | Output Voltage Swing Low (Note 8) | No Load | ● | | | 50 | mV |
| | | $I_{\text{SINK}} = 5\text{mA}$ | ● | | | 195 | mV |
| | | $I_{\text{SINK}} = 15\text{mA}$ | ● | | | 360 | mV |
| V_{OH} | Output Voltage Swing High (Note 8) | No Load | ● | | | 60 | mV |
| | | $I_{\text{SOURCE}} = 5\text{mA}$ | ● | | | 205 | mV |
| | | $I_{\text{SOURCE}} = 15\text{mA}$ | ● | | | 435 | mV |
| I_{SC} | Short-Circuit Current | | ● | ± 35 | | | mA |
| I_{S} | Supply Current per Amplifier Disabled Supply Current per Amplifier | $\overline{\text{ENABLE}} = 4.75\text{V}$ | ● | | | 1.7 | mA |
| | | | ● | | 1 | | μA |
| $I_{\overline{\text{ENABLE}}}$ | $\overline{\text{ENABLE}}$ Pin Current | $\overline{\text{ENABLE}} = 0.3\text{V}$ | ● | | | -95 | μA |
| V_{L} | $\overline{\text{ENABLE}}$ Pin Input Voltage Low | | ● | | | 0.3 | V |
| V_{H} | $\overline{\text{ENABLE}}$ Pin Input Voltage High | | ● | 4.75 | | | V |
| | Output Leakage Current | $\overline{\text{ENABLE}} = 4.75\text{V}$, $V_0 = \pm 1\text{V}$ | ● | | 1 | | μA |
| t_{ON} | Turn-On Time | $\overline{\text{ENABLE}} = 5\text{V}$ to 0V , $R_{\text{L}} = 1\text{k}$ | ● | | 900 | | ns |
| t_{OFF} | Turn-Off Time | $\overline{\text{ENABLE}} = 0\text{V}$ to 5V , $R_{\text{L}} = 1\text{k}$ | ● | | 150 | | μs |
| SR | Slew Rate | $A_{\text{V}} = -1$, $R_{\text{L}} = 1\text{k}$, $V_0 = -2\text{V}$ to 2V | ● | 11 | | | $\text{V}/\mu\text{s}$ |
| | | LT6233-10, $A_{\text{V}} = -10$, $R_{\text{L}} = 1\text{k}$, $V_0 = -2\text{V}$ to 2V | ● | | 105 | | $\text{V}/\mu\text{s}$ |
| FPBW | Full-Power Bandwidth (Note 9) | $V_{\text{OUT}} = 3\text{V}_{\text{P-P}}$; LT6233C, LT6234C, LT6235C | ● | 1.16 | | | MHz |

ELECTRICAL CHARACTERISTICS The ● denotes the specifications which apply over the $-40^{\circ}\text{C} < T_A < 85^{\circ}\text{C}$ temperature range. $V_S = \pm 5\text{V}$, $V_{\text{CM}} = V_{\text{OUT}} = 0\text{V}$, $\text{ENABLE} = 0\text{V}$, unless otherwise noted. (Note 5)

| SYMBOL | PARAMETER | CONDITIONS | | MIN | TYP | MAX | UNITS |
|---------------------|--|--|---|----------|-----|------|--------------------------------|
| V_{OS} | Input Offset Voltage | LT6233IS6, LT6233IS6-10 | ● | | | 700 | μV |
| | | LT6234IS8, LT6235IGN | ● | | | 550 | μV |
| | | LT6234IDD | ● | | | 650 | μV |
| | Input Offset Voltage Match (Channel-to-Channel) (Note 6) | | ● | | | 1000 | μV |
| $V_{\text{OS TC}}$ | Input Offset Voltage Drift (Note 10) | | ● | | 0.5 | 3 | $\mu\text{V}/^{\circ}\text{C}$ |
| I_{B} | Input Bias Current | | ● | | | 4 | μA |
| | I_{B} Match (Channel-to-Channel) (Note 6) | | ● | | | 0.4 | μA |
| I_{OS} | Input Offset Current | | ● | | | 0.5 | μA |
| A_{VOL} | Large-Signal Gain | $V_0 = \pm 4.5\text{V}$, $R_L = 10\text{k}$ | ● | 68 | | | V/mV |
| | | $V_0 = \pm 4.5\text{V}$, $R_L = 1\text{k}$ | ● | 20 | | | V/mV |
| V_{CM} | Input Voltage Range | Guaranteed by CMRR | ● | -3 | | 4 | V |
| CMRR | Common Mode Rejection Ratio | $V_{\text{CM}} = -3\text{V}$ to 4V | ● | 90 | | | dB |
| | CMRR Match (Channel-to-Channel) (Note 6) | $V_{\text{CM}} = -3\text{V}$ to 4V | ● | 84 | | | dB |
| PSRR | Power Supply Rejection Ratio | $V_S = \pm 1.5\text{V}$ to $\pm 5\text{V}$ | ● | 90 | | | dB |
| | PSRR Match (Channel-to-Channel) (Note 6) | $V_S = \pm 1.5\text{V}$ to $\pm 5\text{V}$ | ● | 84 | | | dB |
| V_{OL} | Output Voltage Swing Low (Note 8) | No Load | ● | | | 50 | mV |
| | | $I_{\text{SINK}} = 5\text{mA}$ | ● | | | 195 | mV |
| | | $I_{\text{SINK}} = 15\text{mA}$ | ● | | | 370 | mV |
| V_{OH} | Output Voltage Swing High (Note 8) | No Load | ● | | | 70 | mV |
| | | $I_{\text{SOURCE}} = 5\text{mA}$ | ● | | | 210 | mV |
| | | $I_{\text{SOURCE}} = 15\text{mA}$ | ● | | | 445 | mV |
| I_{SC} | Short-Circuit Current | | ● | ± 30 | | | mA |
| I_{S} | Supply Current per Amplifier | | ● | | | 1.75 | mA |
| | Disabled Supply Current per Amplifier | $\text{ENABLE} = 4.8\text{V}$ | ● | | 1 | | μA |
| I_{ENABLE} | ENABLE Pin Current | $\text{ENABLE} = 0.3\text{V}$ | ● | | | -110 | μA |
| V_{L} | ENABLE Pin Input Voltage Low | | ● | | | 0.3 | V |
| V_{H} | ENABLE Pin Input Voltage High | | ● | 4.8 | | | V |
| | Output Leakage Current | $\text{ENABLE} = 4.8\text{V}$, $V_0 = \pm 1\text{V}$ | ● | | 1 | | μA |
| t_{ON} | Turn-On Time | $\text{ENABLE} = 5\text{V}$ to 0V , $R_L = 1\text{k}$ | ● | | 900 | | ns |
| t_{OFF} | Turn-Off Time | $\text{ENABLE} = 0\text{V}$ to 5V , $R_L = 1\text{k}$ | ● | | 160 | | μs |
| SR | Slew Rate | $A_V = -1$, $R_L = 1\text{k}$, $V_0 = -2\text{V}$ to 2V | ● | 10 | | | $\text{V}/\mu\text{s}$ |
| | | LT6233-10, $A_V = -10$, $R_L = 1\text{k}$, $V_0 = -2\text{V}$ to 2V | ● | | 95 | | $\text{V}/\mu\text{s}$ |
| FPBW | Full-Power Bandwidth (Note 9) | $V_{\text{OUT}} = 3V_{\text{P-P}}$; LT6233I, LT6234I, LT6235I | ● | 1.06 | | | MHz |

Note 1: Stresses beyond those listed under Absolute Maximum Ratings may cause permanent damage to the device. Exposure to any Absolute Maximum Rating condition for extended periods may affect device reliability and lifetime.

Note 2: Inputs are protected by back-to-back diodes. If the differential input voltage exceeds 0.7V, the input current must be limited to less than 40mA.

Note 3: A heat sink may be required to keep the junction temperature below the absolute maximum rating when the output is shorted indefinitely.

Note 4: The LT6233C/LT6233I the LT6234C/LT6234I, and LT6235C/LT6235I are guaranteed functional over the temperature range of -40°C to 85°C .

Note 5: The LT6233C/LT6234C/LT6235C are guaranteed to meet specified performance from 0°C to 70°C . The LT6233C/LT6234C/LT6235C are designed, characterized and expected to meet specified performance from -40°C to 85°C , but are not tested or QA sampled at these temperatures. The LT6233I/LT6234I/LT6235I are guaranteed to meet specified performance from -40°C to 85°C .

Note 6: Matching parameters are the difference between the two amplifiers A and D and between B and C of the LT6235; between the two amplifiers of the LT6234. CMRR and PSRR match are defined as follows: CMRR and PSRR are measured in $\mu\text{V}/\text{V}$ on the matched amplifiers. The difference is calculated between the matching sides in $\mu\text{V}/\text{V}$. The result is converted to dB.

LT6233/LT6233-10 LT6234/LT6235

ELECTRICAL CHARACTERISTICS

Note 7: Minimum supply voltage is guaranteed by power supply rejection ratio test.

Note 8: Output voltage swings are measured between the output and power supply rails.

Note 9: Full-power bandwidth is calculated from the slew rate:

$$FPBW = SR/2\pi V_P$$

Note 10: This parameter is not 100% tested.

TYPICAL PERFORMANCE CHARACTERISTICS (LT6233/LT6234/LT6235)

V_{OS} Distribution

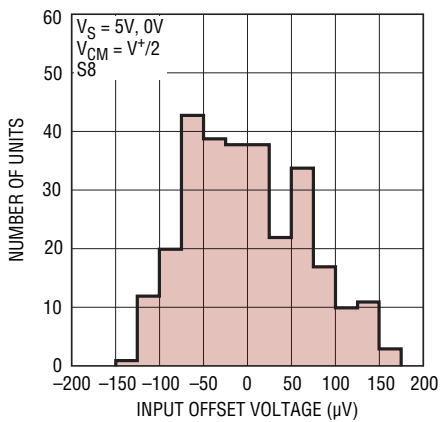

**Supply Current vs Supply Voltage
(Per Amplifier)**

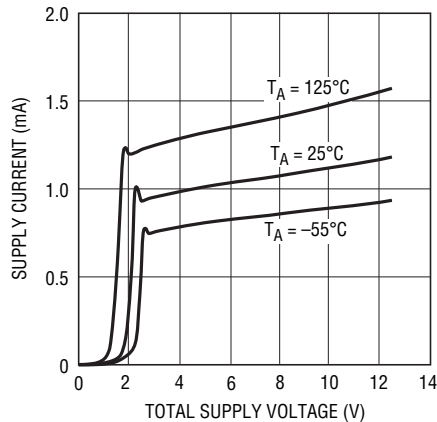

Offset Voltage vs Input Common Mode Voltage

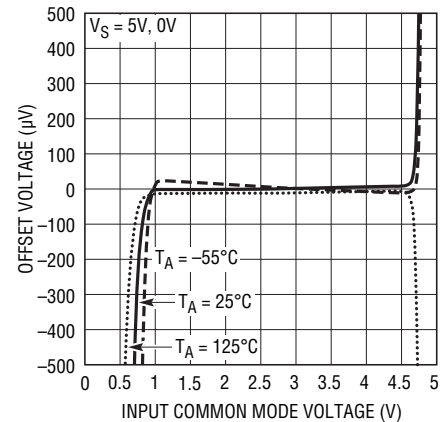

**Input Bias Current
vs Common Mode Voltage**

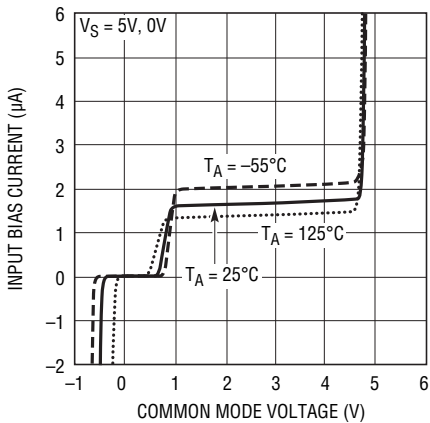

Input Bias Current vs Temperature

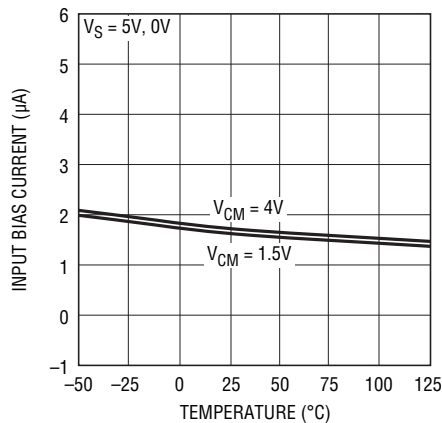

**Output Saturation Voltage
vs Load Current (Output Low)**

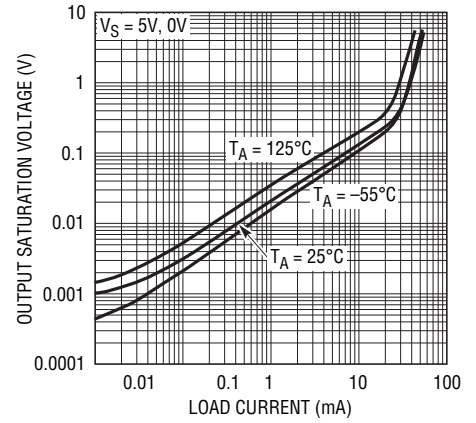

TYPICAL PERFORMANCE CHARACTERISTICS

(LT6233/LT6234/LT6235)

Output Saturation Voltage vs Load Current (Output High)

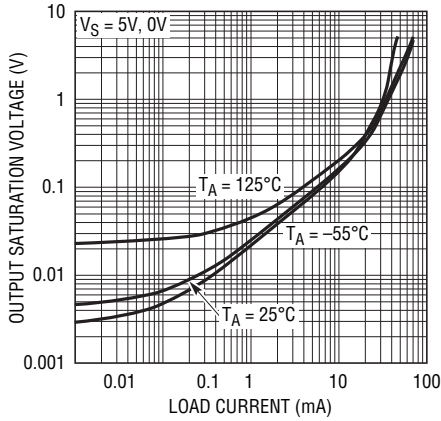

623345 G07

Minimum Supply Voltage

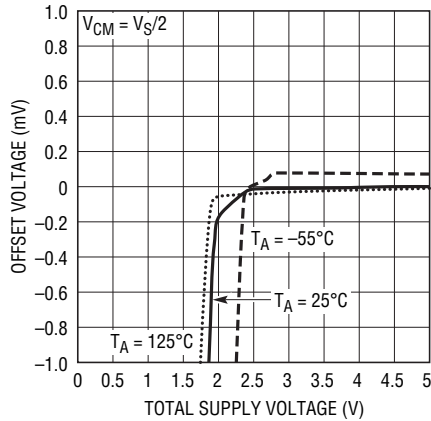

623345 G08

Output Short-Circuit Current vs Power Supply Voltage

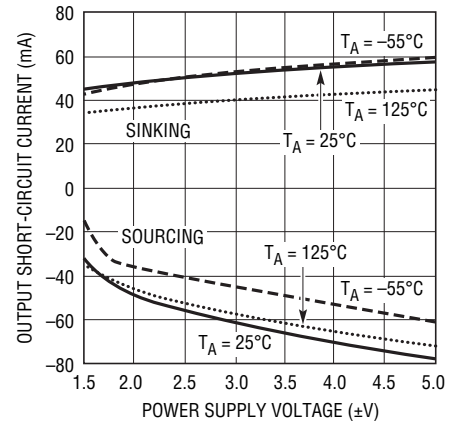

623345 G09

Open-Loop Gain

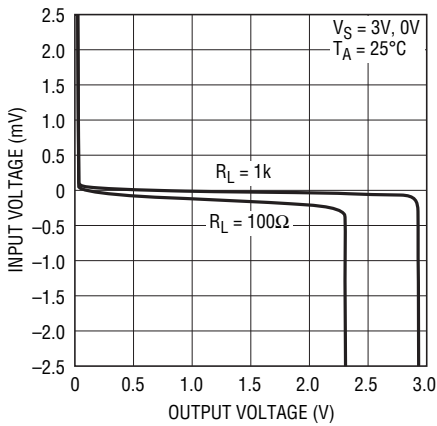

623345 G10

Open-Loop Gain

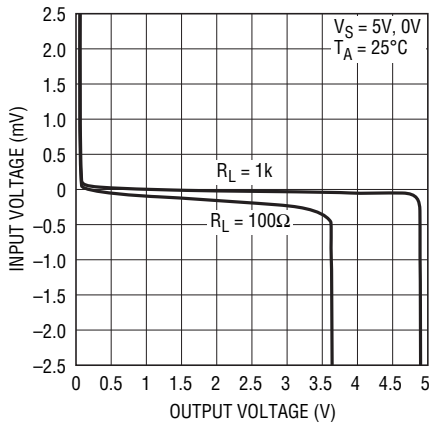

623345 G11

Open-Loop Gain

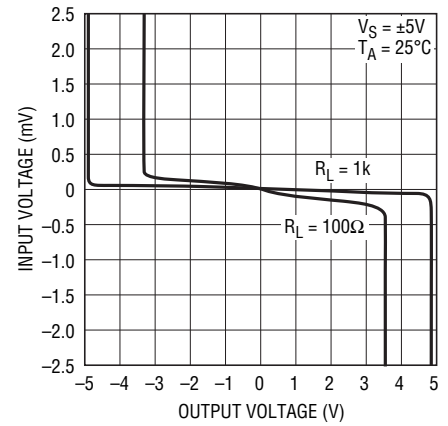

623345 G12

Offset Voltage vs Output Current

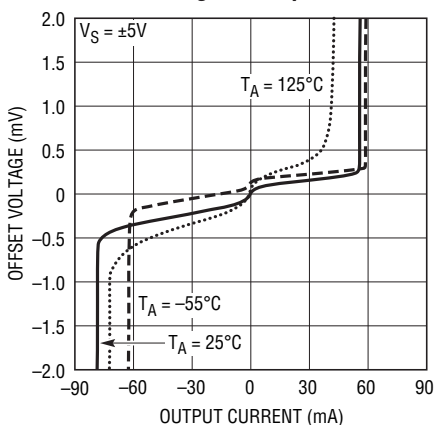

623345 G13

Warm-Up Drift vs Time

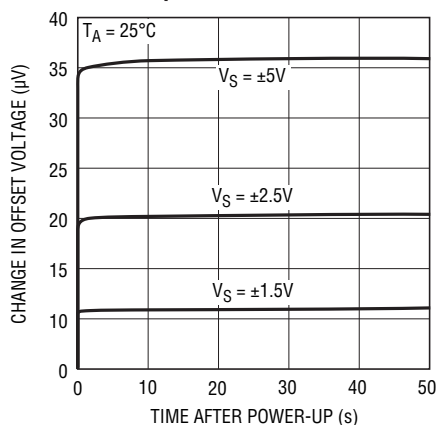

623345 G14

Total Noise vs Total Source Resistance

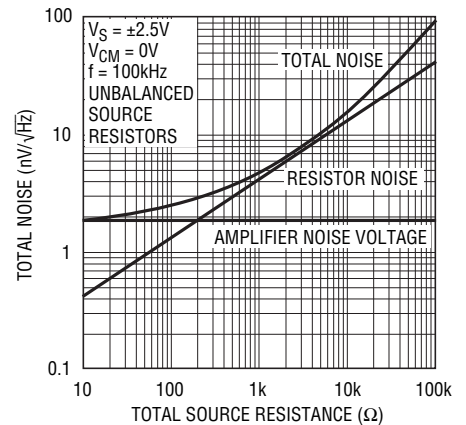

623345 G15

LT6233/LT6233-10 LT6234/LT6235

TYPICAL PERFORMANCE CHARACTERISTICS (LT6233/LT6234/LT6235)

Noise Voltage and Unbalanced Noise Current vs Frequency

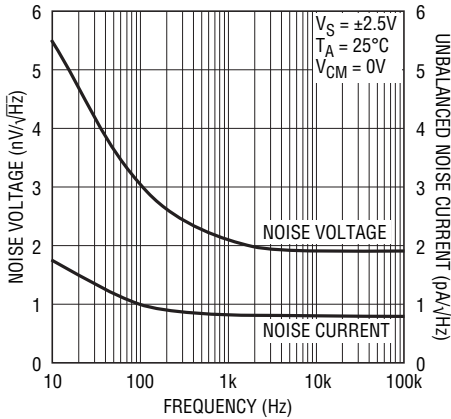

623345 G16

0.1Hz to 10Hz Output Voltage Noise

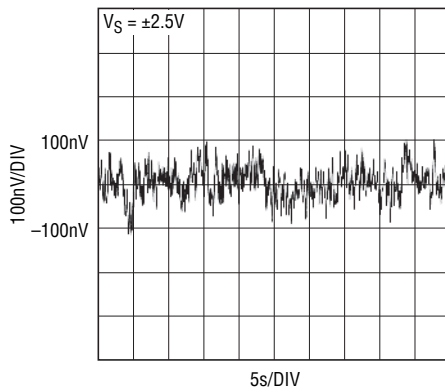

623345 G17

Gain Bandwidth and Phase Margin vs Temperature

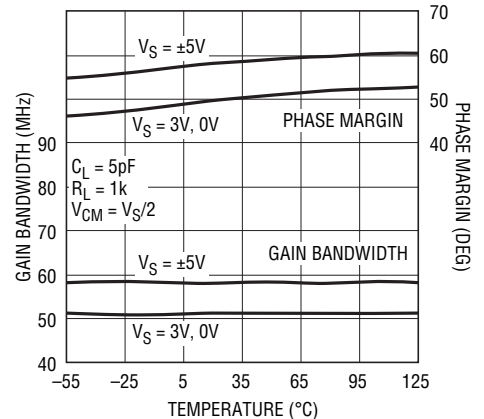

623345 G18

Open-Loop Gain vs Frequency

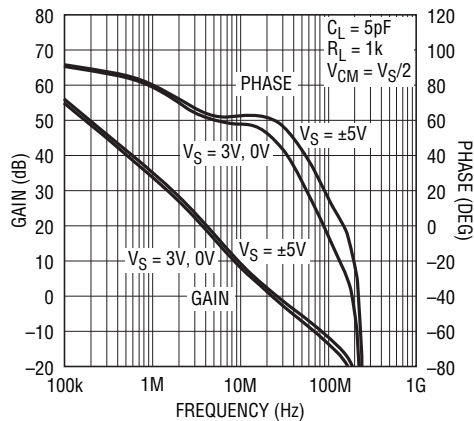

623345 G19

Gain Bandwidth and Phase Margin vs Supply Voltage

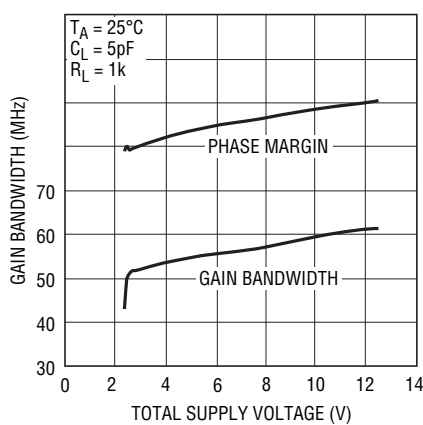

623345 G20

Slew Rate vs Temperature

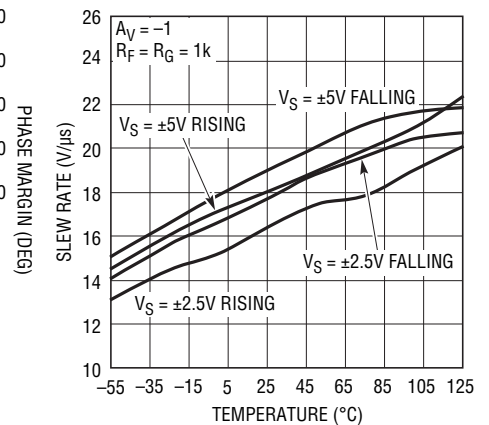

623345 G21

Output Impedance vs Frequency

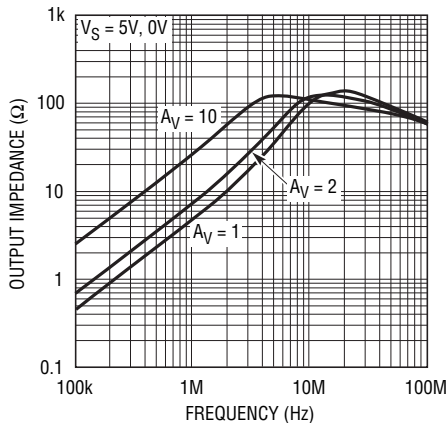

623345 G22

Common Mode Rejection Ratio vs Frequency

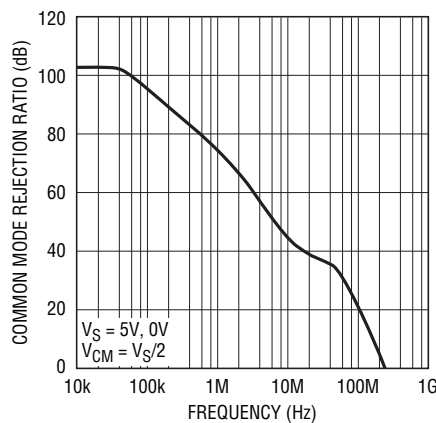

623345 G23

Channel Separation vs Frequency

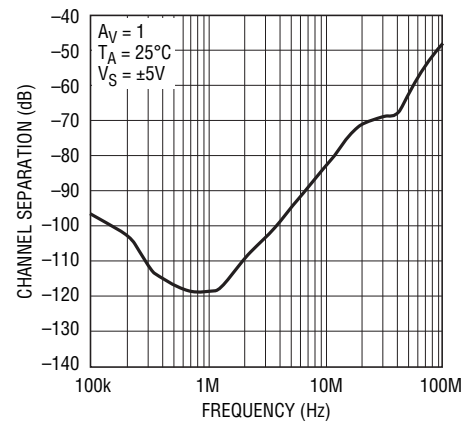

623345 G24

623345fc

TYPICAL PERFORMANCE CHARACTERISTICS

(LT6233/LT6234/LT6235)

Power Supply Rejection Ratio vs Frequency

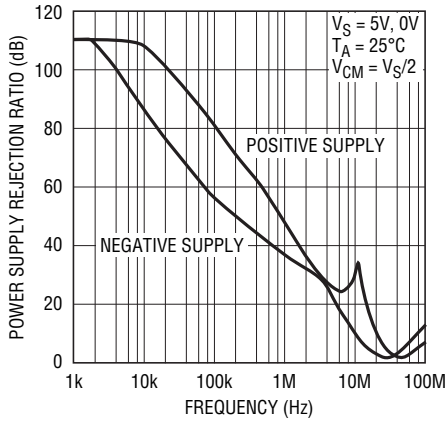

623345 G25

Series Output Resistance and Overshoot vs Capacitive Load

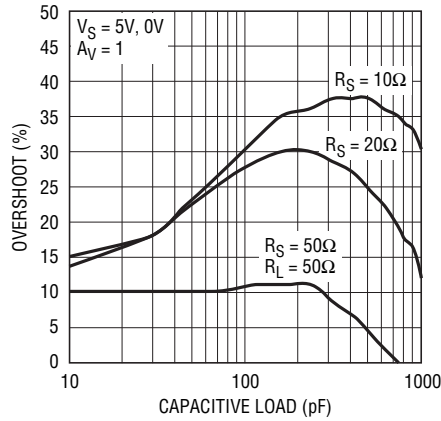

623345 G26

Series Output Resistance and Overshoot vs Capacitive Load

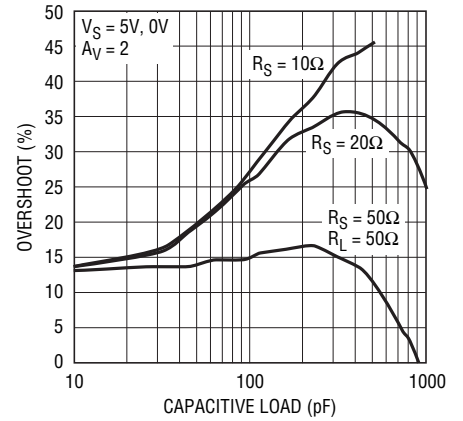

623345 G27

Settling Time vs Output Step (Noninverting)

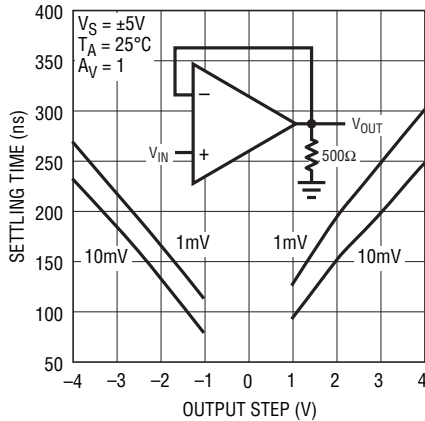

623345 G28

Settling Time vs Output Step (Inverting)

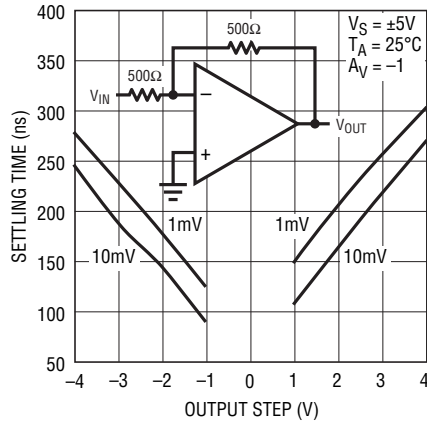

623345 G29

Maximum Undistorted Output Signal vs Frequency

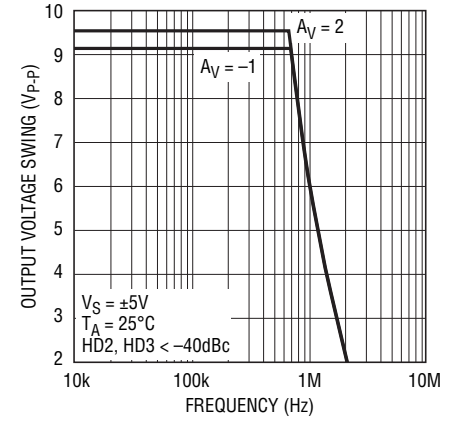

623345 G30

Distortion vs Frequency

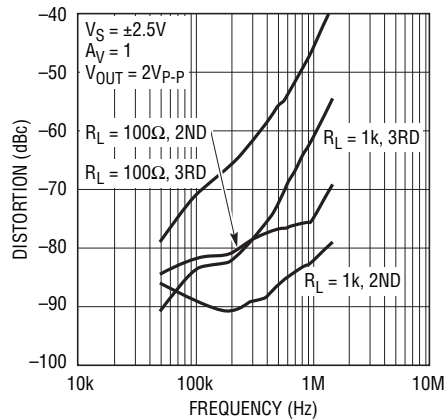

623345 G31

Distortion vs Frequency

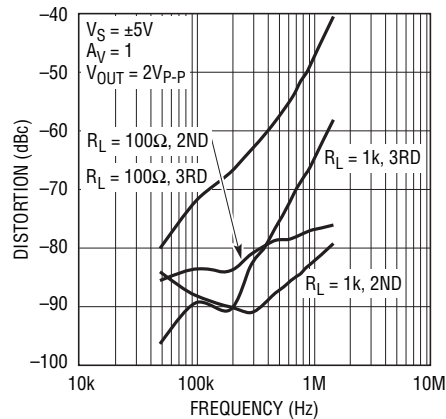

623345 G32

Distortion vs Frequency

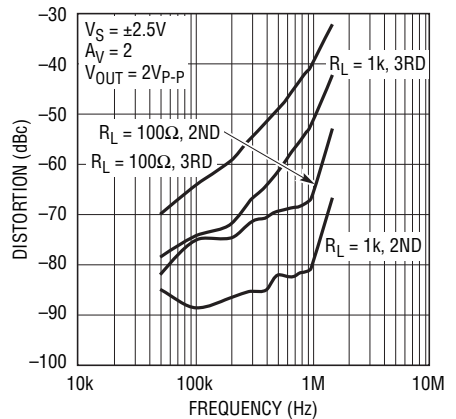

623345 G33

TYPICAL PERFORMANCE CHARACTERISTICS
(LT6233/LT6234/LT6235)

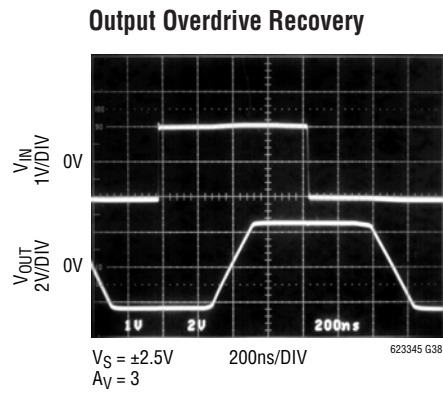
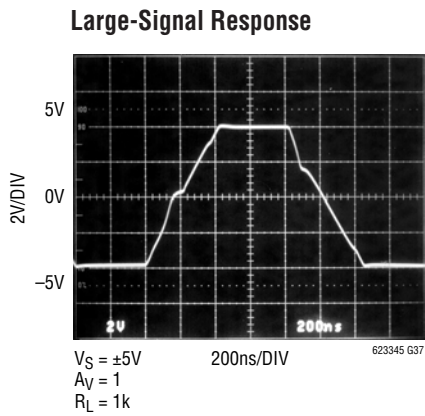
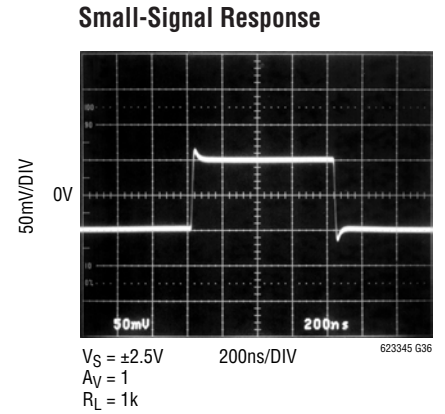
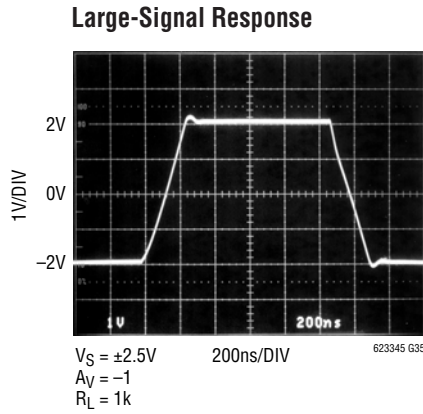
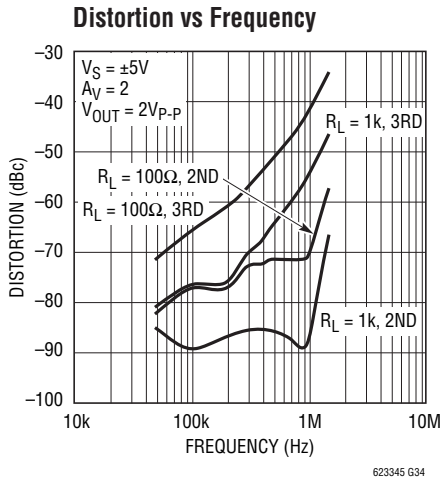

(LT6233) ENABLE Characteristics

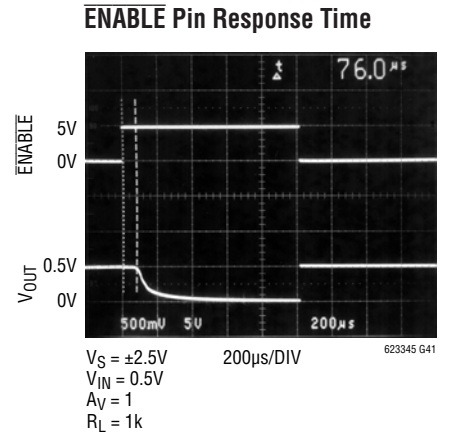
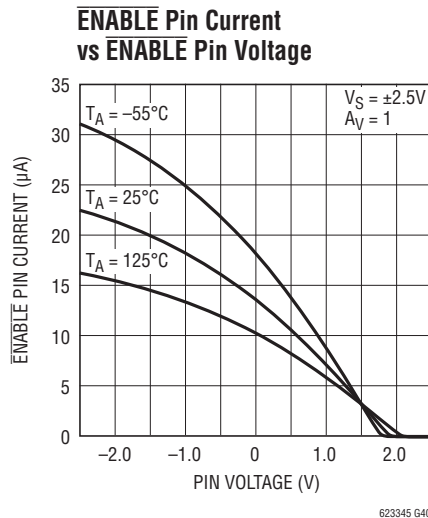
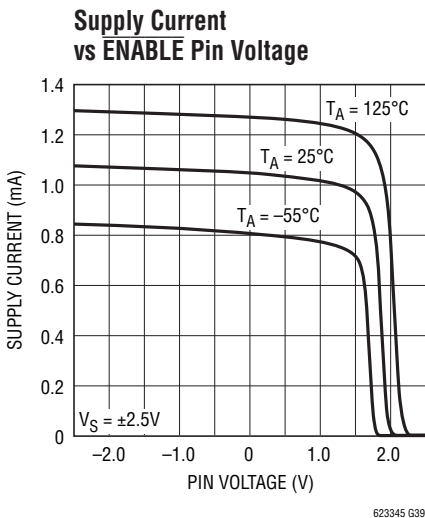

TYPICAL PERFORMANCE CHARACTERISTICS

(LT6233-10)

Gain Bandwidth and Phase Margin vs Temperature

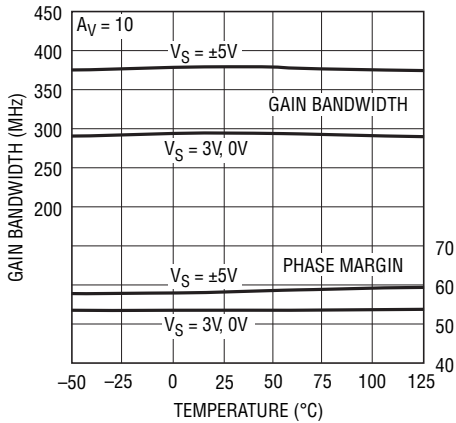

623345 G42

Slew Rate vs Temperature

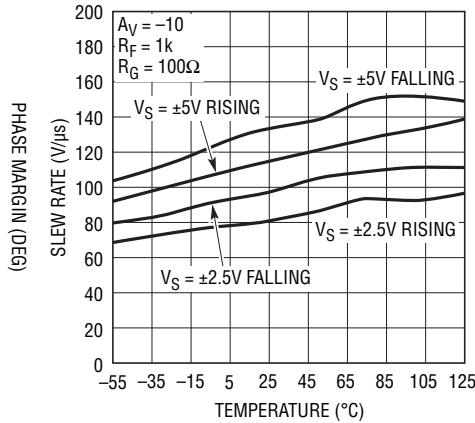

623345 G43

Series Output Resistor and Overshoot vs Capacitive Load

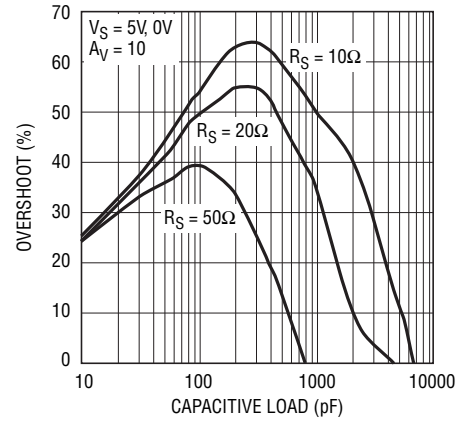

623345 G44

Open-Loop Gain and Phase vs Frequency

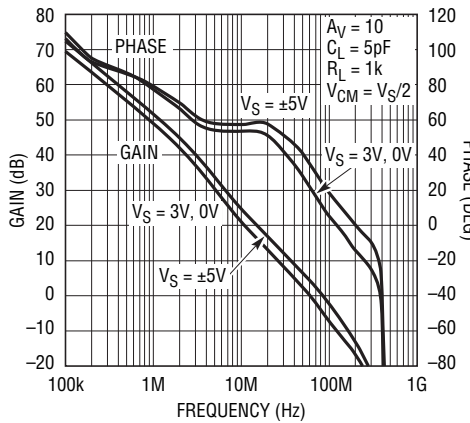

623345 G45

Gain Bandwidth and Phase Margin vs Supply Voltage

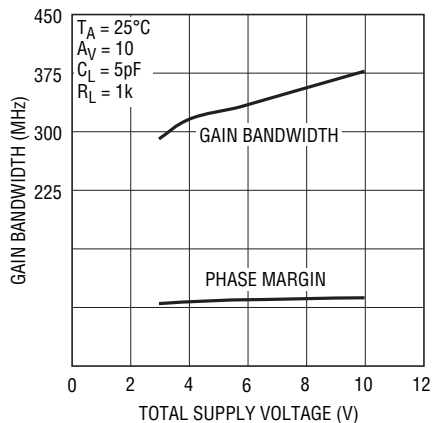

623345 G46

Gain Bandwidth vs Resistor Load

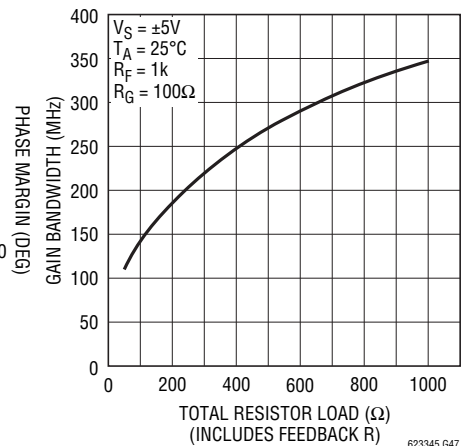

623345 G47

Common Mode Rejection Ratio vs Frequency

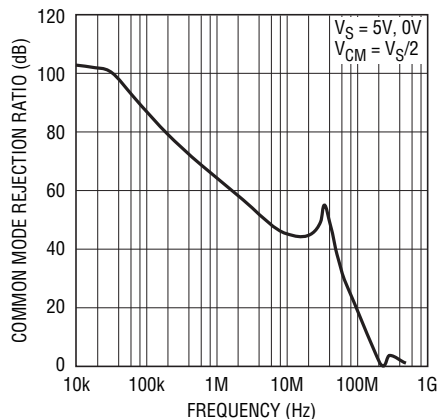

623345 G48

Maximum Undistorted Output vs Frequency

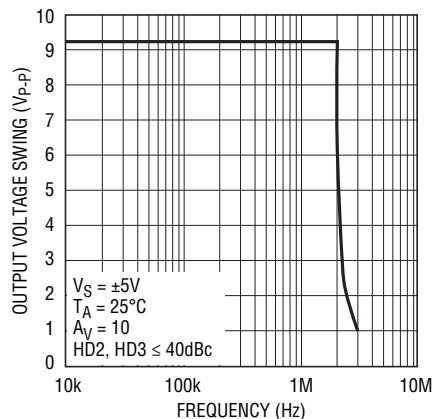

623345 G49

2nd and 3rd Harmonic Distortion vs Frequency

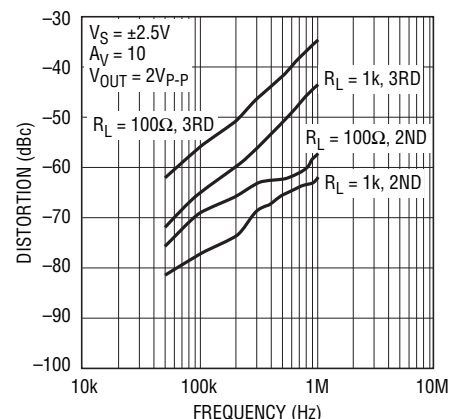

623345 G50
623345fC

TYPICAL PERFORMANCE CHARACTERISTICS

(LT6233-10)

2nd and 3rd Harmonic Distortion vs Frequency

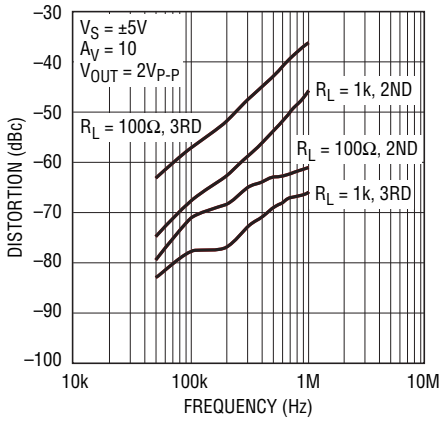

Large-Signal Response

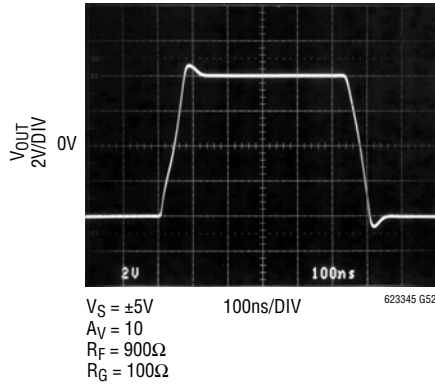

Output-Overload Recovery

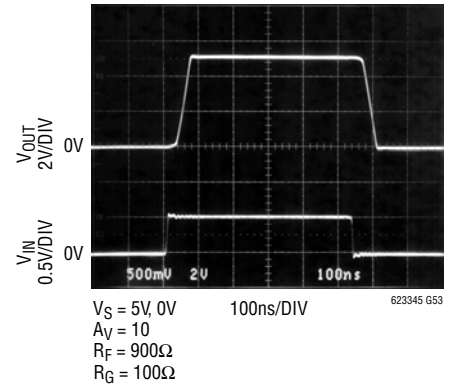

Small-Signal Response

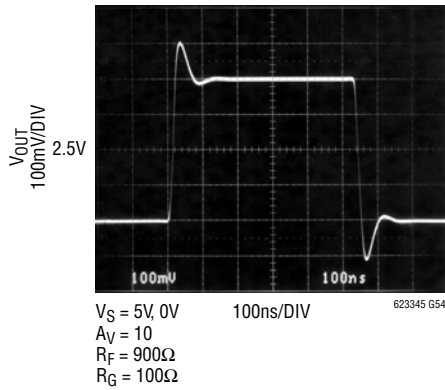

Input Referred High Frequency Noise Spectrum

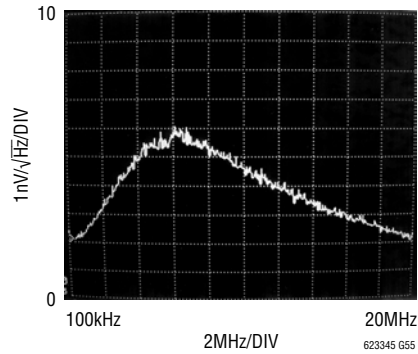

APPLICATIONS INFORMATION

Amplifier Characteristics

Figure 1 is a simplified schematic of the LT6233/LT6234/LT6235, which has a pair of low noise input transistors Q1 and Q2. A simple current mirror Q3/Q4 converts the differential signal to a single-ended output, and these transistors are degenerated to reduce their contribution to the overall noise.

Capacitor C1 reduces the unity-cross frequency and improves the frequency stability without degrading the gain bandwidth of the amplifier. Capacitor C_M sets the overall amplifier gain bandwidth. The differential drive generator supplies current to transistors Q5 and Q6 that swing the output from rail-to-rail.

Input Protection

There are back-to-back diodes, D1 and D2 across the + and – inputs of these amplifiers to limit the differential input voltage to $\pm 0.7V$. The inputs of the LT6233/LT6234/LT6235 do not have internal resistors in series with the input transistors. This technique is often used to protect the input devices from overvoltage that causes excessive current to flow. The addition of these resistors would significantly degrade the low noise voltage of these amplifiers. For instance, a 100Ω resistor in series with each input would generate $1.8nV/\sqrt{Hz}$ of noise, and the total amplifier noise voltage would rise from $1.9nV/\sqrt{Hz}$ to $2.6nV/\sqrt{Hz}$. Once the input differential voltage exceeds $\pm 0.7V$, steady-state current conducted through the protection diodes should

be limited to $\pm 40mA$. This implies 25Ω of protection resistance is necessary per volt of overdrive beyond $\pm 0.7V$. These input diodes are rugged enough to handle transient currents due to amplifier slew rate overdrive and clipping without protection resistors.

The photo of Figure 2 shows the output response to an input overdrive with the amplifier connected as a voltage follower. With the input signal low, current source I₁ saturates and the differential drive generator drives Q6 into saturation so the output voltage swings all the way to V⁻. The input can swing positive until transistor Q2 saturates into current mirror Q3/Q4. When saturation occurs, the output tries to phase invert, but diode D2 conducts current from the signal source to the output through the feedback connection. The output is clamped a diode drop below the input. In this photo, the input signal generator is limiting at about 20mA.

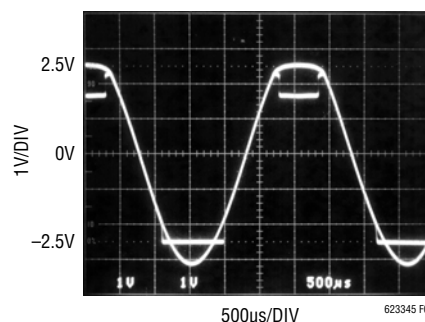

Figure 2. V_S = $\pm 2.5V$, A_V = 1 with Large Overdrive

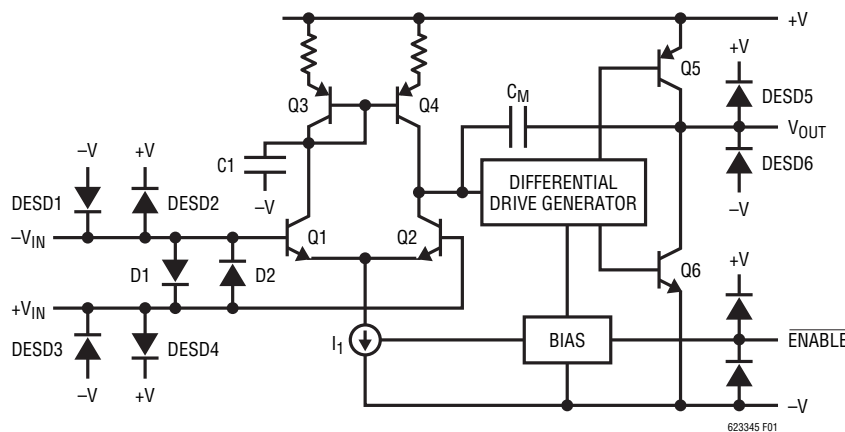

Figure 1. Simplified Schematic

APPLICATIONS INFORMATION

With the amplifier connected in a gain of $A_V \geq 2$, the output can invert with very heavy overdrive. To avoid this inversion, limit the input overdrive to 0.5V beyond the power supply rails.

ESD

The LT6233/LT6234/LT6235 have reverse-biased ESD protection diodes on all inputs and outputs as shown in Figure 1. If these pins are forced beyond either supply, unlimited current will flow through these diodes. If the current is transient and limited to one hundred milliamps or less, no damage to the device will occur.

Noise

The noise voltage of the LT6233/LT6234/LT6235 is equivalent to that of a 225Ω resistor, and for the lowest possible noise it is desirable to keep the source and feedback resistance at or below this value, i.e., $R_S + R_G || R_{FB} \leq 225\Omega$. With $R_S + R_G || R_{FB} = 225\Omega$ the total noise of the amplifier is:

$$e_N = \sqrt{(1.9\text{nV})^2 + (1.9\text{nV})^2} = 2.69\text{nV}/\sqrt{\text{Hz}}$$

Below this resistance value, the amplifier dominates the noise, but in the region between 225Ω and about 30k, the noise is dominated by the resistor thermal noise. As the total resistance is further increased beyond 30k, the amplifier noise current multiplied by the total resistance eventually dominates the noise.

The product of $e_N \cdot \sqrt{I_{\text{SUPPLY}}}$ is an interesting way to gauge low noise amplifiers. Most low noise amplifiers with low e_N have high I_{SUPPLY} current. In applications that require low noise voltage with the lowest possible supply current, this product can prove to be enlightening. The LT6233/LT6234/LT6235 have an $e_N \cdot \sqrt{I_{\text{SUPPLY}}}$ product of only 2.1 per amplifier, yet it is common to see amplifiers with similar noise specifications to have $e_N \cdot \sqrt{I_{\text{SUPPLY}}}$ as high as 13.5.

For a complete discussion of amplifier noise, see the LT1028 data sheet.

Enable Pin

The LT6233 and LT6233-10 include an $\overline{\text{ENABLE}}$ pin that shuts down the amplifier to 10μA maximum supply current. The $\overline{\text{ENABLE}}$ pin must be driven low to operate the amplifier with normal supply current. The $\overline{\text{ENABLE}}$ pin must be driven high to within 0.35V of V^+ to shut down the supply current. This can be accomplished with simple gate logic; however care must be taken if the logic and the LT6233 operate from different supplies. If this is the case, then open-drain logic can be used with a pull-up resistor to ensure that the amplifier remains off. See Typical Performance Characteristics.

The output leakage current when disabled is very low; however, current can flow into the input protection diodes D1 and D2 if the output voltage exceeds the input voltage by a diode drop.

TYPICAL APPLICATIONS

Single Supply, Low Noise, Low Power, Bandpass Filter with Gain = 10

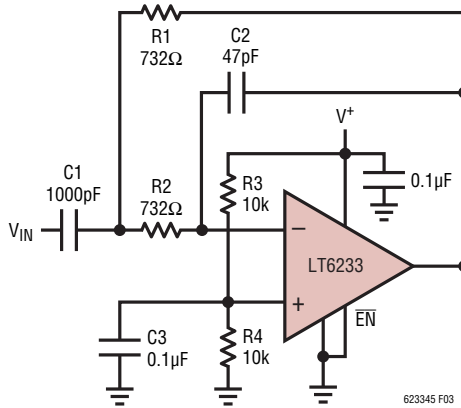

$$f_0 = \frac{1}{2\pi RC} = 1\text{MHz}$$

$$C = \sqrt{C1 \cdot C2} \quad R = R1 = R2$$

$$f_0 = \left(\frac{732\Omega}{R}\right)\text{MHz, MAXIMUM } f_0 = 1\text{MHz}$$

$$f_{-3dB} = \frac{f_0}{2.5}$$

$$A_V = 20\text{dB at } f_0$$

$$E_N = 6\mu\text{VRMS INPUT REFERRED}$$

$$I_S = 1.5\text{mA FOR } V^+ = 5\text{V}$$

Frequency Response Plot of Bandpass Filter

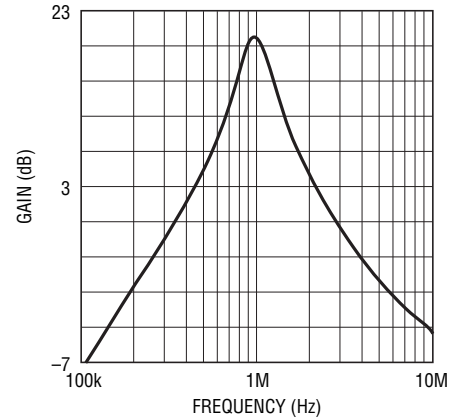

623345 F04

Low Power, Low Noise, Single Supply, Instrumentation Amplifier with Gain = 100

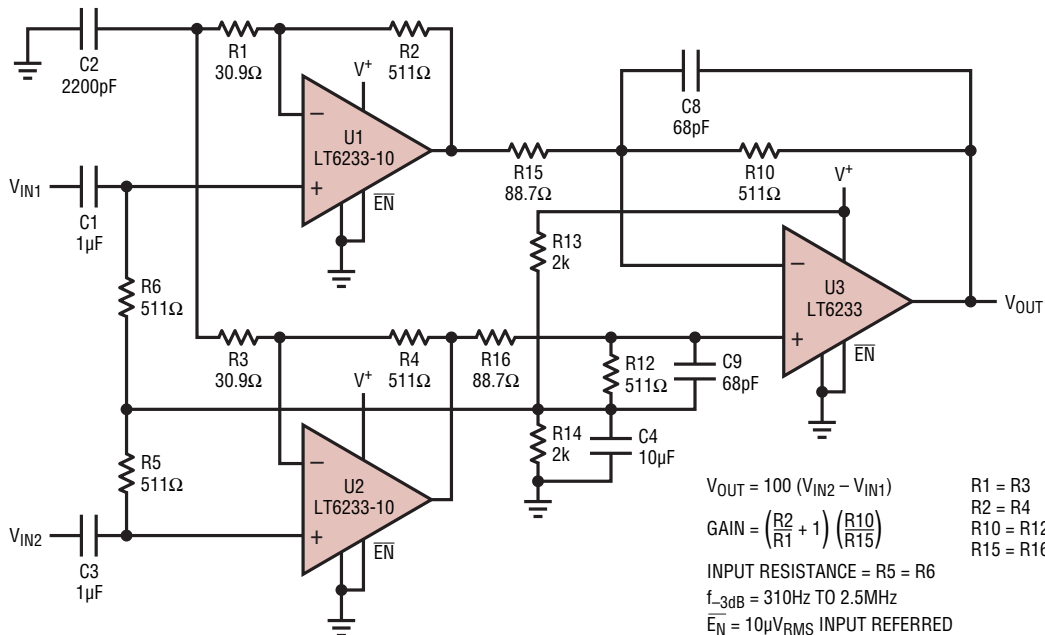

$$V_{OUT} = 100 (V_{IN2} - V_{IN1})$$

$$\text{GAIN} = \left(\frac{R2}{R1} + 1\right) \left(\frac{R10}{R15}\right)$$

$$\text{INPUT RESISTANCE} = R5 = R6$$

$$f_{-3dB} = 310\text{Hz TO } 2.5\text{MHz}$$

$$E_N = 10\mu\text{VRMS INPUT REFERRED}$$

$$I_S = 4.7\text{mA FOR } V_S = 5\text{V, } 0\text{V}$$

$$R1 = R3$$

$$R2 = R4$$

$$R10 = R12$$

$$R15 = R16$$

623345 F05

LT6233/LT6233-10 LT6234/LT6235

PACKAGE DESCRIPTION

S6 Package 6-Lead Plastic TSOT-23 (Reference LTC DWG # 05-08-1636)

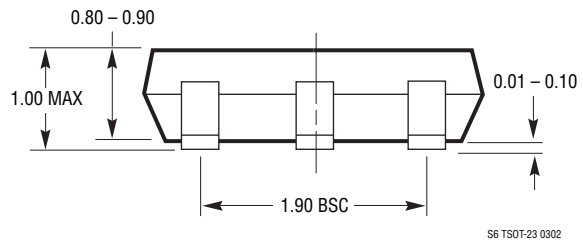
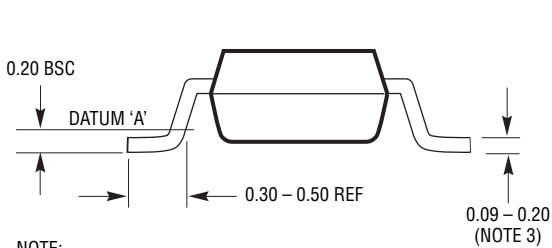
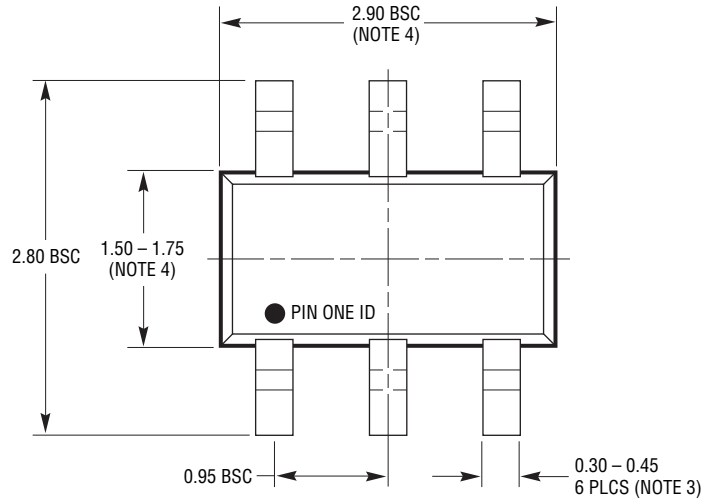
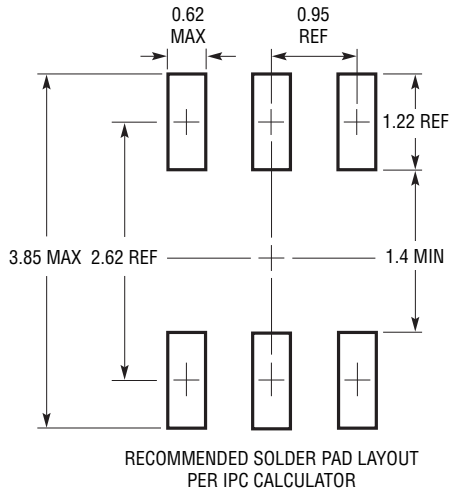

- NOTE:
1. DIMENSIONS ARE IN MILLIMETERS
 2. DRAWING NOT TO SCALE
 3. DIMENSIONS ARE INCLUSIVE OF PLATING
 4. DIMENSIONS ARE EXCLUSIVE OF MOLD FLASH AND METAL BURR
 5. MOLD FLASH SHALL NOT EXCEED 0.254mm
 6. JEDEC PACKAGE REFERENCE IS MO-193

S6 TSOT-23 0302

PACKAGE DESCRIPTION

DD Package
8-Lead Plastic DFN (3mm × 3mm)
 (Reference LTC DWG # 05-08-1698 Rev C)

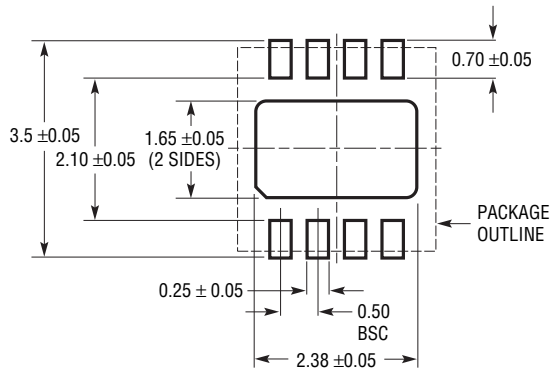

RECOMMENDED SOLDER PAD PITCH AND DIMENSIONS
 APPLY SOLDER MASK TO AREAS THAT ARE NOT SOLDERED

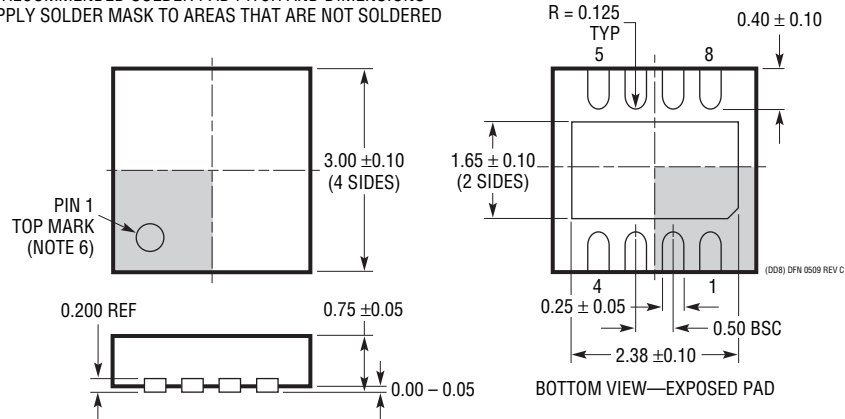

NOTE:

1. DRAWING TO BE MADE A JEDEC PACKAGE OUTLINE M0-229 VARIATION OF (WEED-1)
2. DRAWING NOT TO SCALE
3. ALL DIMENSIONS ARE IN MILLIMETERS
4. DIMENSIONS OF EXPOSED PAD ON BOTTOM OF PACKAGE DO NOT INCLUDE MOLD FLASH. MOLD FLASH, IF PRESENT, SHALL NOT EXCEED 0.15mm ON ANY SIDE
5. EXPOSED PAD SHALL BE SOLDER PLATED
6. SHADED AREA IS ONLY A REFERENCE FOR PIN 1 LOCATION ON TOP AND BOTTOM OF PACKAGE

PACKAGE DESCRIPTION

S8 Package 8-Lead Plastic Small Outline (Narrow .150 Inch) (Reference LTC DWG # 05-08-1610)

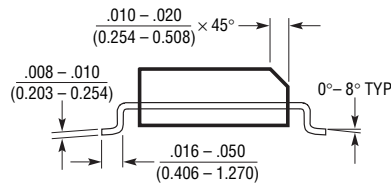
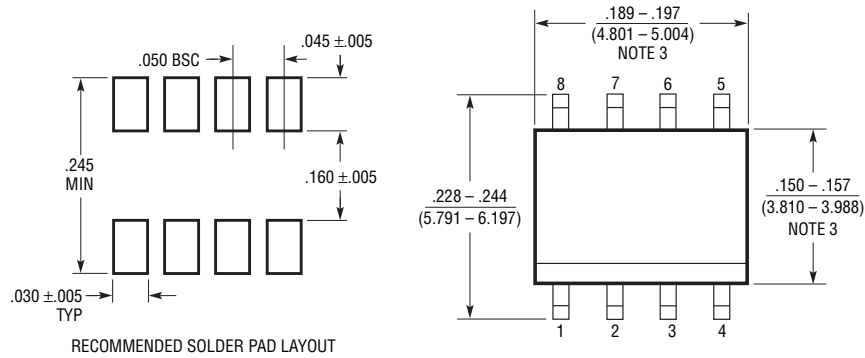

- NOTE:
 1. DIMENSIONS IN $\frac{\text{INCHES}}{\text{MILLIMETERS}}$
 2. DRAWING NOT TO SCALE
 3. THESE DIMENSIONS DO NOT INCLUDE MOLD FLASH OR PROTRUSIONS.
 MOLD FLASH OR PROTRUSIONS SHALL NOT EXCEED .006" (0.15mm)

S08 0203

GN Package 16-Lead Plastic SSOP (Narrow .150 Inch) (Reference LTC DWG # 05-08-1641)

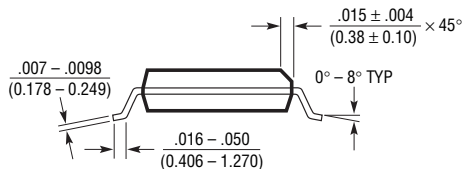
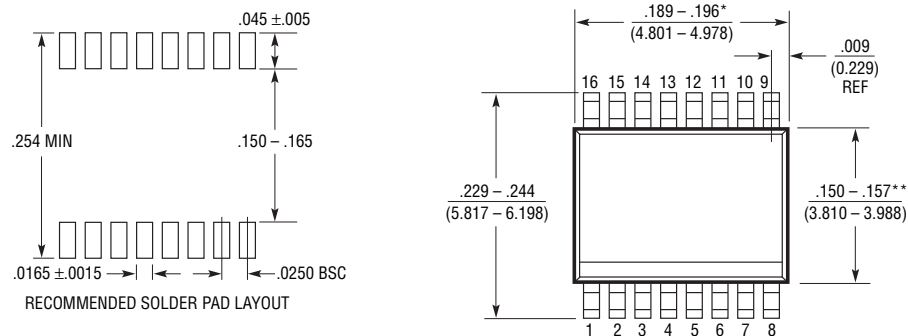

- NOTE:
 1. CONTROLLING DIMENSION: INCHES
 2. DIMENSIONS ARE IN $\frac{\text{INCHES}}{\text{MILLIMETERS}}$
 3. DRAWING NOT TO SCALE
 *DIMENSION DOES NOT INCLUDE MOLD FLASH. MOLD FLASH SHALL NOT EXCEED 0.006" (0.152mm) PER SIDE
 **DIMENSION DOES NOT INCLUDE INTERLEAD FLASH. INTERLEAD FLASH SHALL NOT EXCEED 0.010" (0.254mm) PER SIDE

GN16 (SSOP) 0204

REVISION HISTORY (Revision history begins at Rev C)

| REV | DATE | DESCRIPTION | PAGE NUMBER |
|-----|------|--|-------------|
| C | 1/11 | Revised y-axis label on curve G40 in Typical Performance Characteristics | 14 |
| | | Updated ENABLE Pin section in Applications Information | 18 |

LT6233/LT6233-10

LT6234/LT6235

TYPICAL APPLICATIONS

The LT6233 is applied as a transimpedance amplifier with an I-to-V conversion gain of $10\text{k}\Omega$ set by R1. The LT6233 is ideally suited to this application because of its low input offset voltage and current, and its low noise. This is because the 10k resistor has an inherent thermal noise of $13\text{nV}/\sqrt{\text{Hz}}$ or $1.3\text{pA}/\sqrt{\text{Hz}}$ at room temperature, while the LT6233 contributes only 2nV and $0.8\text{pA}/\sqrt{\text{Hz}}$. So, with respect to both voltage and current noises, the LT6233 is actually quieter than the gain resistor.

The circuit uses an avalanche photodiode with the cathode biased to approximately 200V . When light is incident on

the photodiode, it induces a current I_{PD} which flows into the amplifier circuit. The amplifier output falls negative to maintain balance at its inputs. The transfer function is therefore $V_{\text{OUT}} = -I_{\text{PD}} \cdot 10\text{k}$. C1 ensures stability and good settling characteristics. Output offset was measured at better than $500\mu\text{V}$, so low in part because R2 serves to cancel the DC effects of bias current. Output noise was measured at below $1\text{mV}_{\text{p-p}}$ on a 20MHz measurement bandwidth, with C2 shunting R2's thermal noise. As shown in the scope photo, the rise time is 45ns , indicating a signal bandwidth of 7.8MHz .

Low Power Avalanche Photodiode Transimpedance Amplifier
 $I_{\text{S}} = 1.2\text{mA}$

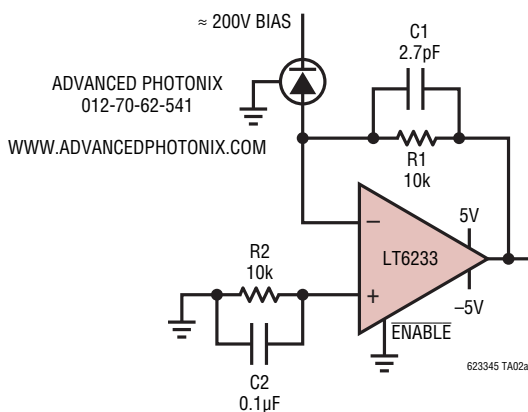

OUTPUT OFFSET = $500\mu\text{V}$ TYPICAL
 BANDWIDTH = 7.8MHz
 OUTPUT NOISE = $1\text{mV}_{\text{p-p}}$ (20MHz MEASUREMENT BW)

Photodiode Amplifier Time Domain Response

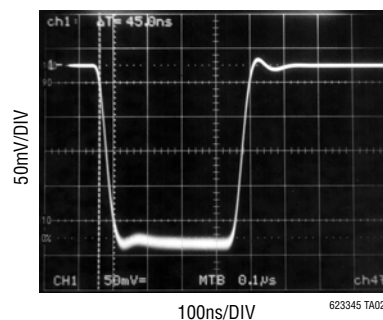

RELATED PARTS

| PART NUMBER | DESCRIPTION | COMMENTS |
|----------------------|--|--|
| LT1028 | Single, Ultralow Noise 50MHz Op Amp | $0.85\text{nV}/\sqrt{\text{Hz}}$ |
| LT1677 | Single, Low Noise Rail-to-Rail Amplifier | 3V Operation, 2.5mA, $4.5\text{nV}/\sqrt{\text{Hz}}$, $60\mu\text{V}$ Max V_{OS} |
| LT1806/LT1807 | Single/Dual, Low Noise 325MHz Rail-to-Rail Amplifier | 2.5V Operation, $550\mu\text{V}$ Max V_{OS} , $3.5\text{nV}/\sqrt{\text{Hz}}$ |
| LT6200/LT6201 | Single/Dual, Low Noise 165MHz | $0.95\text{nV}/\sqrt{\text{Hz}}$, Rail-to-Rail Input and Output |
| LT6202/LT6203/LT6204 | Single/Dual/Quad, Low Noise, Rail-to-Rail Amplifier | $1.9\text{nV}/\sqrt{\text{Hz}}$, 3mA Max, 100MHz Gain Bandwidth |