

SIDACtor® Protection Thyristor Series - DO-214



Description

Series DO-214AA are designed to protect baseband equipment such as modems, line cards, CPE and DSL from damaging overvoltage transients.

The series provides a surface mount solution that enables equipment to comply with global regulatory standards.

Features and Benefits

- Low voltage overshoot
- Low on-state voltage
- Does not degrade surge capability after multiple surge events within limit.
- Low capacitance
- Fails short circuit when surged in excess of ratings
- 2nd level interconnect is Pb-free per IPC/JEDEC J-STD-609A.01
- RoHS compliant, lead-free and halogen-free.

Agency Approvals

| AGENCY | AGENCY FILE NUMBER |
|---|--------------------|
|  | E133083 |

Pinout Designation

Not Applicable

Schematic Symbol



Applicable Global Standards

- TIA-968-A
- TIA-968-B
- ITU K.20/21/45 Enhanced Level*
- ITU K.20/21/45 Basic Level
- GR 1089 Inter-building*
- GR 1089 Intra-building
- IEC 61000-4-5 2nd edition
- YD/T 1082
- YD/T 993
- YD/T 950

*A/B-rated parts require series resistance

Electrical Characteristics

| Part Number | Marking | V_{DRM} @ $I_{DRM}=5\mu A$ | V_S @ 100V/ μs | I_H | I_S | I_T | V_T @ $I_T=2.2$ Amps | Capacitance @ 1MHz, 2V bias | |
|-------------|---------|---------------------------------|--------------------------|--------|--------|-------|---------------------------|--------------------------------|--------|
| | | V min | V max | mA min | mA max | A max | V max | pF min | pF max |
| P0080SALRP | P-8A | 6 | 25 | 50 | 800 | 2.2 | 4 | 20 | 35 |
| P0220SALRP | P22A | 15 | 32 | 50 | 800 | 2.2 | 4 | 20 | 40 |
| P0300SALRP | P03A | 25 | 40 | 50 | 800 | 2.2 | 4 | 15 | 40 |
| P0640SALRP | P06A | 58 | 77 | 150 | 800 | 2.2 | 4 | 15 | 40 |
| P0720SALRP | P07A | 65 | 88 | 150 | 800 | 2.2 | 4 | 15 | 40 |
| P0900SALRP | P09A | 75 | 98 | 150 | 800 | 2.2 | 4 | 15 | 40 |
| P1100SALRP | P11A | 90 | 130 | 150 | 800 | 2.2 | 4 | 15 | 40 |
| P1300SALRP | P13A | 120 | 160 | 150 | 800 | 2.2 | 4 | 15 | 40 |
| P1500SALRP | P15A | 140 | 180 | 150 | 800 | 2.2 | 4 | 15 | 40 |
| P1800SALRP | P18A | 170 | 220 | 150 | 800 | 2.2 | 4 | 15 | 35 |
| P2100SALRP | P21A | 180 | 240 | 150 | 800 | 2.2 | 4 | 15 | 35 |
| P2300SALRP | P23A | 190 | 260 | 150 | 800 | 2.2 | 4 | 15 | 35 |
| P2600SALRP | P26A | 220 | 300 | 150 | 800 | 2.2 | 4 | 15 | 35 |
| P3100SALRP | P31A | 275 | 350 | 150 | 800 | 2.2 | 4 | 15 | 35 |
| P3500SALRP | P35A | 320 | 400 | 150 | 800 | 2.2 | 4 | 15 | 35 |
| P0080SBLRP | P-8B | 6 | 25 | 50 | 800 | 2.2 | 4 | 20 | 50 |
| P0220SBLRP | P22B | 15 | 32 | 50 | 800 | 2.2 | 4 | 20 | 50 |
| P0300SBLRP | P03B | 25 | 40 | 50 | 800 | 2.2 | 4 | 15 | 50 |
| P0640SBLRP | P06B | 58 | 77 | 150 | 800 | 2.2 | 4 | 20 | 50 |
| P0720SBLRP | P07B | 65 | 88 | 150 | 800 | 2.2 | 4 | 20 | 50 |

Table continues on next page.

Electrical Parameters (continued)

| Part Number | Marking | V_{DRM} @ $I_{DRM}=5\mu A$ | V_S @ 100V/ μs | I_H | I_S | I_T | V_T @ $I_T=2.2$ Amps | Capacitance @ 1MHz, 2V bias | |
|---------------|---------|---------------------------------|--------------------------|--------|--------|-------|---------------------------|--------------------------------|--------|
| | | V min | V max | mA min | mA max | A max | V max | pF min | pF max |
| P0900SBLRP | P09B | 75 | 98 | 150 | 800 | 2.2 | 4 | 20 | 50 |
| P1100SBLRP | P11B | 90 | 130 | 150 | 800 | 2.2 | 4 | 20 | 50 |
| P1300SBLRP | P13B | 120 | 160 | 150 | 800 | 2.2 | 4 | 20 | 50 |
| P1500SBLRP | P15B | 140 | 180 | 150 | 800 | 2.2 | 4 | 20 | 50 |
| P1800SBLRP | P18B | 170 | 220 | 150 | 800 | 2.2 | 4 | 20 | 50 |
| P2100SBLRP | P21B | 180 | 240 | 150 | 800 | 2.2 | 4 | 20 | 35 |
| P2300SBLRP | P23B | 190 | 260 | 150 | 800 | 2.2 | 4 | 20 | 50 |
| P2600SBLRP | P26B | 220 | 300 | 150 | 800 | 2.2 | 4 | 20 | 35 |
| P3100SBLRP | P31B | 275 | 350 | 150 | 800 | 2.2 | 4 | 20 | 35 |
| P3500SBLRP | P35B | 320 | 400 | 150 | 800 | 2.2 | 4 | 20 | 35 |
| P4500SBLRP | P45B | 400 | 530 | 150 | 800 | 2.2 | 4 | 20 | 50 |
| P0080SCLRP | P-8C | 6 | 25 | 50 | 800 | 2.2 | 4 | 25 | 70 |
| P0220SCLRP | P22C | 15 | 32 | 50 | 800 | 2.2 | 4 | 25 | 70 |
| P0300SCLRP | P03C | 25 | 40 | 50 | 800 | 2.2 | 4 | 20 | 50 |
| P0640SCLRP | P06C | 58 | 77 | 150 | 800 | 2.2 | 4 | 45 | 100 |
| P0720SCLRP | P07C | 65 | 88 | 150 | 800 | 2.2 | 4 | 45 | 100 |
| P0900SCLRP | P09C | 75 | 98 | 150 | 800 | 2.2 | 4 | 45 | 100 |
| P1100SCLRP | P11C | 90 | 130 | 150 | 800 | 2.2 | 4 | 45 | 90 |
| P1300SCLRP | P13C | 120 | 160 | 150 | 800 | 2.2 | 4 | 40 | 85 |
| P1500SCLRP | P15C | 140 | 180 | 150 | 800 | 2.2 | 4 | 25 | 70 |
| P1800SCLRP | P18C | 170 | 220 | 150 | 800 | 2.2 | 4 | 25 | 70 |
| P2100SCLRP | P21C | 180 | 240 | 150 | 800 | 2.2 | 4 | 25 | 70 |
| P2300SCLRP | P23C | 190 | 260 | 150 | 800 | 2.2 | 4 | 25 | 70 |
| P2600SCLRP | P26C | 220 | 300 | 150 | 800 | 2.2 | 4 | 30 | 70 |
| P3100SCLRP | P31C | 275 | 350 | 150 | 800 | 2.2 | 4 | 30 | 70 |
| P3500SCLRP | P35C | 320 | 400 | 150 | 800 | 2.2 | 4 | 25 | 65 |
| P4500SCLRP | P45C | 400 | 530 | 150 | 800 | 2.2 | 4 | 25 | 65 |
| P4500SCLHLRP* | P45L | 400 | 530 | 50 | 800 | 2.2 | 4 | 20 | 50 |

Notes:
 - Absolute maximum ratings measured at $T_A = 25^\circ C$ (unless otherwise noted).
 - Components are bi-directional.
 - * P4500SCLHLRP is low I_H product

Surge Ratings

| Series | I_{PP} | | | | | | | | | | I_{TSM} 50/60 Hz | di/dt |
|--------|----------------------|-------------------|---------------------|---------------------|---------------------|--------------------|---------------------|----------------------|---------------------|---------------------|-----------------------|-------------------|
| | 0.2/310 ¹ | 2/10 ¹ | 8/20 ¹ | 10/160 ¹ | 10/560 ¹ | 5/320 ¹ | 10/360 ¹ | 10/1000 ¹ | 5/310 ¹ | 10/700 ¹ | | |
| | 0.5/700 ² | 2/10 ² | 1.2/50 ² | 10/160 ² | 10/560 ² | 9/720 ² | 10/360 ² | 10/1000 ² | 10/700 ² | | | |
| | A min | A min | A min | A min | A min | A min | A min | A min | A min | A min | A min | Amps/ μs max |
| A | 20 | 150 | 150 | 90 | 50 | 75 | 75 | 45 | 75 | 25 | 500 | |
| B | 25 | 250 | 250 | 150 | 100 | 100 | 125 | 80 | 100 | 30 | 500 | |
| C | 50 | 500 | 400 | 200 | 150 | 200 | 175 | 100 | 200 ³ | 35 | 500 | |

Notes:
 1 Current waveform in μs
 2 Voltage waveform in μs
 3 For surge rating of P4500SCLRP 10/700 μs min=150A & typical=180A
 For surge rating of P4500SCLHLRP 10/700 μs min=150A
 - Peak pulse current rating (I_{pp}) is repetitive and guaranteed for the life of the product.
 - I_{pp} ratings applicable over temperature range of $-40^\circ C$ to $+85^\circ C$
 - The component must initially be in thermal equilibrium with $-40^\circ C \leq T_J \leq +150^\circ C$

Thermal Considerations

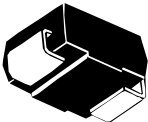
| Package | Symbol | Parameter | Value | Unit |
|---|-----------------|---|-------------|------|
|  DO-214AA | T_J | Operating Junction Temperature Range | -40 to +150 | °C |
| | T_S | Storage Temperature Range | -65 to +150 | °C |
| | $R_{\theta JA}$ | Thermal Resistance: Junction to Ambient | 90 | °C/W |

V-I Characteristics

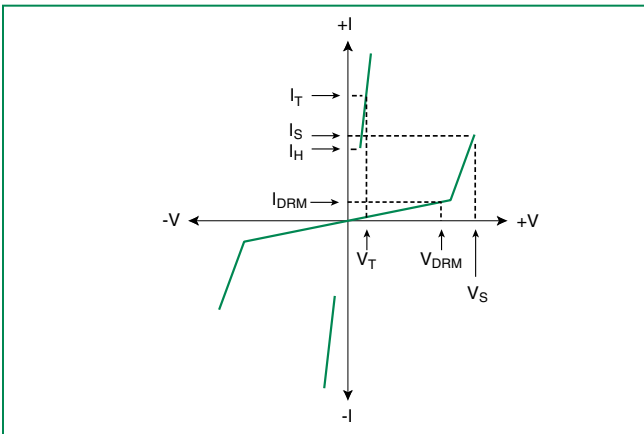

$t_r \times t_d$ Pulse Waveform

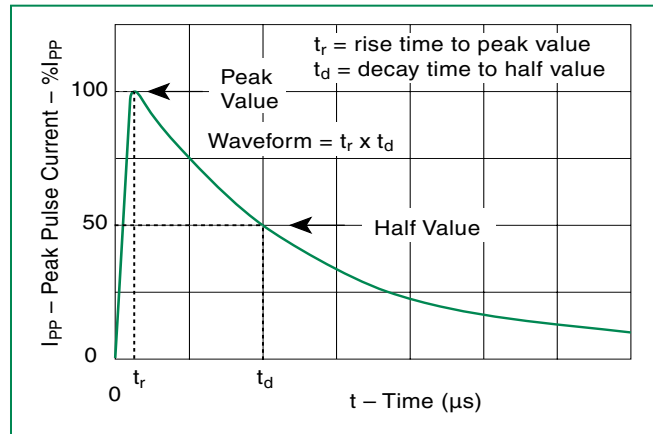

Normalized V_S Change vs. Junction Temperature

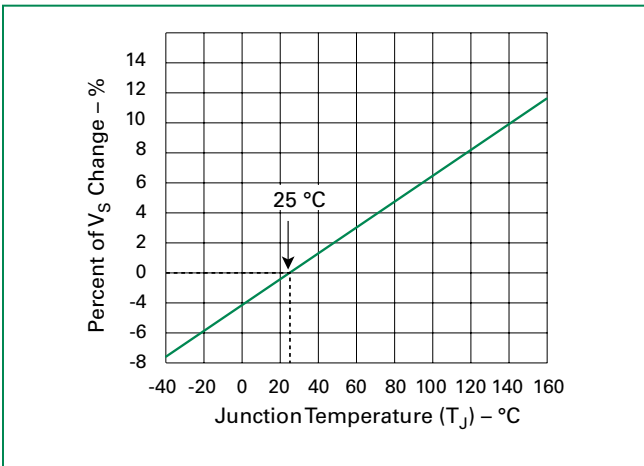

Normalized DC Holding Current vs. Case Temperature

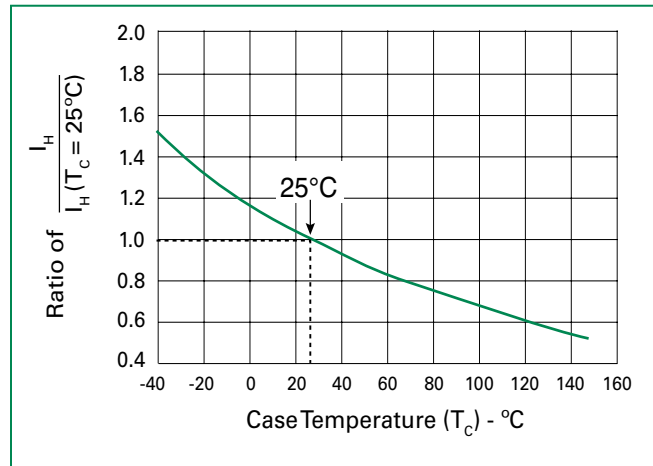

Additional Information



Datasheet



Resources



Samples

Soldering Parameters

| | | |
|--|-----------------------------------|--------------|
| Reflow Condition | Pb-Free assembly (see Fig. 1) | |
| Pre Heat | -Temperature Min ($T_{s(min)}$) | +150°C |
| | -Temperature Max ($T_{s(max)}$) | +200°C |
| | -Time (Min to Max) (t_s) | 60-180 secs. |
| Average ramp up rate (Liquidus Temp (T_L) to peak) | 3°C/sec. Max. | |
| $T_{s(max)}$ to T_L - Ramp-up Rate | 3°C/sec. Max. | |
| Reflow | -Temperature (T_L) (Liquidus) | +217°C |
| | -Temperature (t_L) | 60-150 secs. |
| Peak Temp (T_p) | +260(+0/-5)°C | |
| Time within 5°C of actual Peak Temp (t_p) | 30 secs. Max. | |
| Ramp-down Rate | 6°C/sec. Max. | |
| Time 25°C to Peak Temp (T_p) | 8 min. Max. | |
| Do not exceed | +260°C | |

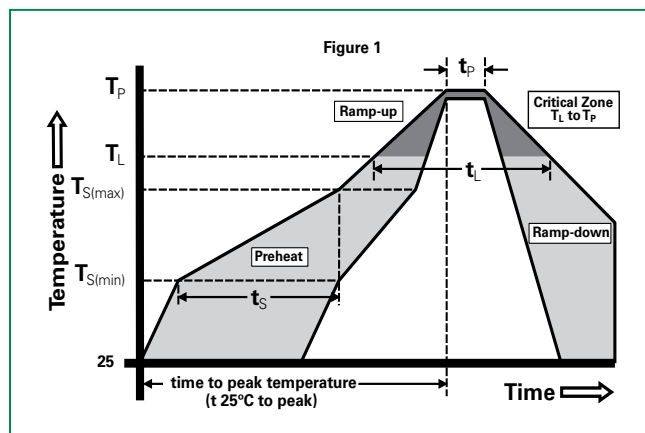

Physical Specifications

| | |
|------------------------|---|
| Lead Material | Copper Alloy |
| Terminal Finish | 100% Matte-Tin Plated |
| Body Material | UL recognized epoxy meeting flammability classification V-0 |

Environmental Specifications

| | |
|---|---|
| High Temp Voltage Blocking | 80% Rated V_{DRM} (V_{AC} Peak) +125°C or +150°C, 504 or 1008 hrs. MIL-STD-750 (Method 1040) JEDEC, JESD22-A-101 |
| Temp Cycling | -65°C to +150°C, 15 min. dwell, 10 up to 100 cycles. MIL-STD-750 (Method 1051) EIA/JEDEC, JESD22-A104 |
| Biased Temp & Humidity | 52 V_{DC} (+85°C) 85%RH, 504 up to 1008 hrs. EIA/JEDEC, JESD22-A-101 |
| High Temp Storage | +150°C 1008 hrs. MIL-STD-750 (Method 1031) JEDEC, JESD22-A-101 |
| Low Temp Storage | -65°C, 1008 hrs. |
| Thermal Shock | 0°C to +100°C, 5 min. dwell, 10 sec. transfer, 10 cycles. MIL-STD-750 (Method 1056) JEDEC, JESD22-A-106 |
| Autoclave (Pressure Cooker Test) | +121°C, 100%RH, 2atm, 24 up to 168 hrs. EIA/JEDEC, JESD22-A-102 |
| Resistance to Solder Heat | +260°C, 30 secs. MIL-STD-750 (Method 2031) |
| Moisture Sensitivity Level | 85%RH, +85°C, 168 hrs., 3 reflow cycles (+260°C Peak). JEDEC-J-STD-020, Level 1 |

Part Numbering

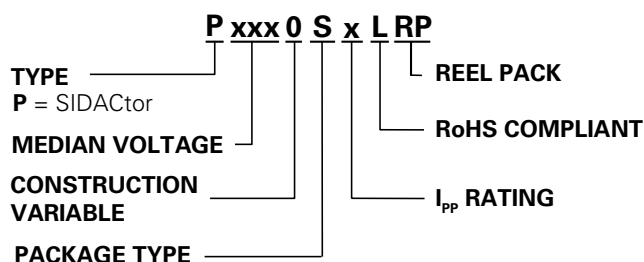

Part Marking

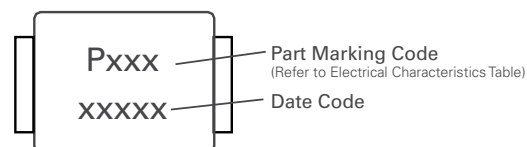

Dimensions – DO-214AA

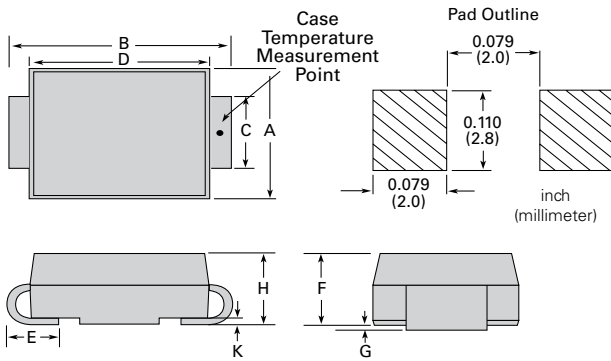

| Dimensions | Inches | | Millimeters | |
|----------------|--------|-------|-------------|------|
| | Min | Max | Min | Max |
| A | 0.130 | 0.156 | 3.30 | 3.95 |
| B | 0.201 | 0.220 | 5.10 | 5.60 |
| C | 0.077 | 0.087 | 1.95 | 2.20 |
| D | 0.159 | 0.181 | 4.05 | 4.60 |
| E | 0.030 | 0.063 | 0.75 | 1.60 |
| F | 0.075 | 0.096 | 1.90 | 2.45 |
| G | 0.002 | 0.008 | 0.05 | 0.20 |
| H | 0.077 | 0.104 | 1.95 | 2.65 |
| H- P4500SCLHLP | 0.077 | 0.096 | 1.95 | 2.43 |
| K | 0.006 | 0.016 | 0.15 | 0.41 |

Packing Options

| Package Type | Description | Quantity | Added Suffix | Industry Standard |
|--------------|------------------------------|----------|--------------|-------------------|
| S | DO-214AA Tape & Reel Pack | 2500 | RP | EIA-481-D |

Tape and Reel Specification – DO-214AA

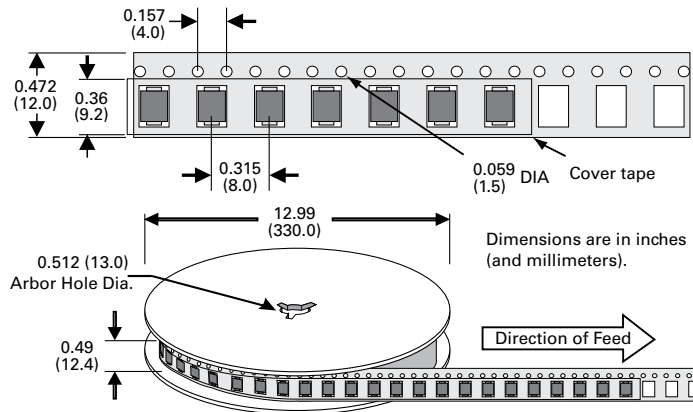

Disclaimer Notice - Information furnished is believed to be accurate and reliable. However, users should independently evaluate the suitability of and test each product selected for their own applications. Littelfuse products are not designed for, and may not be used in, all applications. Read complete Disclaimer Notice at www.littelfuse.com/disclaimer-electronics.