

High Isolation, Linear Current Sensor IC with 850 $\mu\Omega$ Current Conductor

FEATURES AND BENEFITS

- IEC/UL 60950-1 Ed. 2 certified to:
 - Dielectric Strength = 4800 Vrms (tested for 60 seconds)
 - Basic Isolation = 1550 Vpeak
 - Reinforced Isolation = 800 Vpeak
- Small footprint, low-profile SOIC16 wide-body package suitable for space constrained applications that require high galvanic isolation
- 0.85 m Ω primary conductor for low power loss and high inrush current withstand capability
- Low, 400 $\mu\text{A}_{\text{RMS}}\sqrt{\text{Hz}}$ noise density results in typical input referred noise of 70 mA(rms) at max bandwidth (40 kHz)
- 3.3 V, single supply operation
- Output voltage proportional to AC or DC current
- Factory-trimmed sensitivity and quiescent output voltage for improved accuracy
- Chopper stabilization results in extremely stable quiescent output voltage
- Ratiometric output from supply voltage



TÜV America
Certificate Number:
U8V 14 11 54214 030
CB 14 11 54214 029



Package: 16-Pin SOICW (suffix MA)

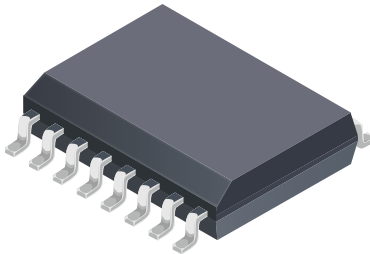

Approximate Scale 1:1

DESCRIPTION

The Allegro™ ACS717 current sensor IC is an economical, high isolation solution for AC or DC current sensing in industrial, commercial, and communications systems. The small package is ideal for space constrained applications, though the wide-body provides the creepage and clearance needed for high isolation. Typical applications include motor control, load detection and management, switched-mode power supplies, and overcurrent fault protection.

The device consists of a low-offset, linear Hall sensor circuit with a copper conduction path located near the surface of the die. Applied current flowing through this copper conduction path generates a magnetic field which is sensed by the integrated Hall IC and converted into a proportional voltage. Device accuracy is optimized through the close proximity of the magnetic field to the Hall transducer. A proportional voltage is provided by the low-offset, chopper-stabilized BiCMOS Hall IC, which is programmed for accuracy after packaging. The output of the device has a positive slope when an increasing current flows through the primary copper conduction path (from pins 1 through 4, to pins 5 through 8), which is the path used for current sensing. The internal resistance of this conductive path is 0.85 m Ω typical, providing low power loss.

The terminals of the conductive path are electrically isolated from the sensor leads (pins 10 through 15). This allows the ACS717 current sensor IC to be used in high-side current sense applications without the use of high-side differential amplifiers or other costly isolation techniques.

The ACS717 is provided in a small, low profile surface mount SOICW16 package (suffix MA). The device is lead (Pb) free with 100% matte tin leadframe plating. The device is fully calibrated prior to shipment from the factory.

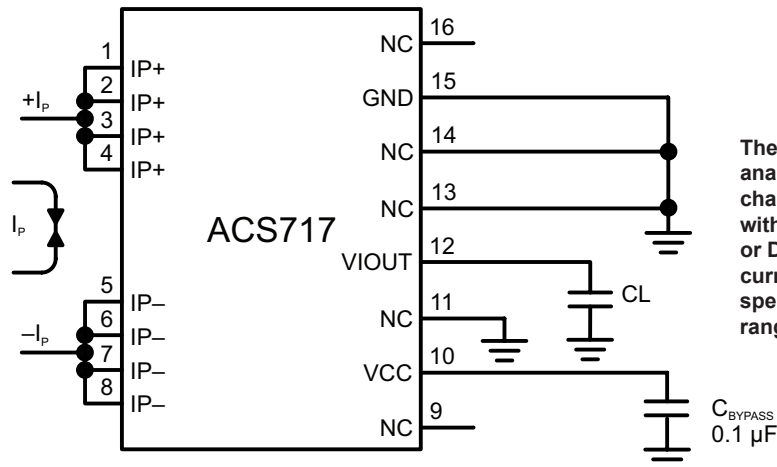

Typical Application

SPECIFICATIONS

Selection Guide

Part Number	I_P (A)	Sens(Typ) at $V_{CC} = 3.3\text{ V}$ (mV/A)	T_A (°C)	Packing ¹
ACS717KMATR-10B-T ²	± 10	132	-40 to 125	Tape and reel, 1000 pieces per reel
ACS717KMATR-20B-T ²	± 20	66		



¹Contact Allegro for additional packing options.

²Variant not intended for automotive applications.

Absolute Maximum Ratings

Characteristic	Symbol	Notes	Rating	Units
Supply Voltage	V_{CC}		7	V
Reverse Supply Voltage	V_{RCC}		-0.1	V
Output Voltage	V_{IOUT}		25	V
Reverse Output Voltage	V_{RIOUT}		-0.1	V
Operating Ambient Temperature	T_A	Range K	-40 to 125	°C
Junction Temperature	$T_{J(max)}$		165	°C
Storage Temperature	T_{stg}		-65 to 165	°C

Isolation Characteristics

Characteristic	Symbol	Notes	Rating	Unit
Dielectric Strength Test Voltage	V_{ISO}	Agency type tested for 60 seconds per IEC/UL 60950-1 (2nd Edition). Production tested for 1 second at 3000 V_{RMS} in accordance with IEC/UL 60950-1 (2nd Edition).	4800	V_{RMS}
Working Voltage for Basic Isolation	V_{WVBI}	Maximum approved working voltage for basic (single) isolation according IEC/UL 60950-1 (2nd Edition).	1550	V_{PK}
			1097	V_{RMS} or VDC
Working Voltage for Reinforced Isolation	V_{WVRI}	Maximum approved working voltage for reinforced isolation according to IEC/UL 60950-1 (2nd Edition)	800	V_{PK}
			565	V_{RMS} or VDC
Clearance	D_{cl}	Minimum distance through air from IP leads to signal leads.	7.5	mm
Creepage*	D_{cr}	Minimum distance along package body from IP leads to signal leads.	8.2	mm

*In order to maintain this creepage in applications, the user should add a slit in the PCB under the package. Otherwise, the pads on the PCB will reduce the creepage.

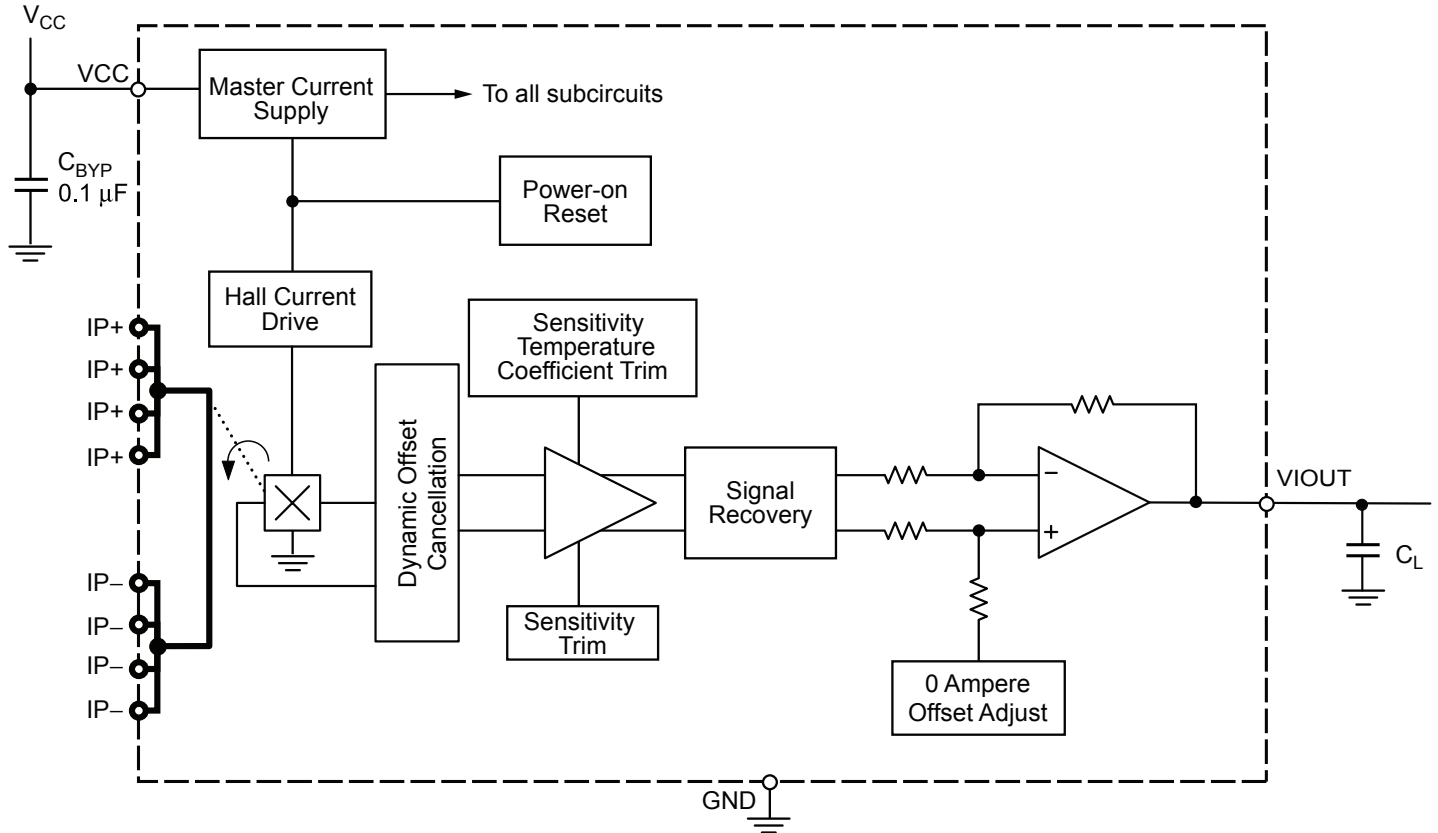

Functional Block Diagram

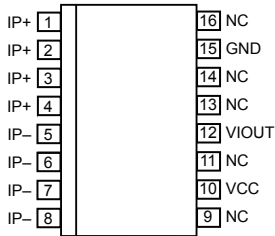

Package MA, 16-Pin
SOICW

Terminal List Table

Number	Name	Description
1, 2, 3, 4	IP+	Terminals for current being sensed; fused internally
5, 6, 7, 8	IP-	Terminals for current being sensed; fused internally
9, 16	NC	No internal connection; recommended to be left unconnected in order to maintain high creepage.
11, 13, 14	NC	No internal connection; recommended to connect to GND for the best ESD performance
10	VCC	Device power supply terminal
12	VIOUT	Analog output signal
15	GND	Signal ground terminal

COMMON ELECTRICAL CHARACTERISTICS¹: T_A Range K, valid at $T_A = -40^\circ\text{C}$ to 125°C , $V_{CC} = 3.3\text{ V}$, unless otherwise specified

Characteristic	Symbol	Test Conditions	Min.	Typ.	Max.	Units
Supply Voltage	V_{CC}		3	3.3	3.6	V
Supply Current	I_{CC}	$V_{CC(\min)} < V_{CC} < V_{CC(\max)}$; output open	–	6	7.5	mA
Output Capacitance Load	C_L	VIOUT to GND	–	–	1	nF
Output Resistive Load	R_L	VIOUT to GND	15	–	–	k Ω
Primary Conductor Resistance	R_P	$T_A = 25^\circ\text{C}$	–	0.85	–	m Ω
Rise Time	t_r	$I_P = I_P(\max)$, $T_A = 25^\circ\text{C}$, $C_L = \text{open}$	–	10	–	μs
Magnetic Coupling Factor	C_F		–	4.5	–	G/A
Propagation Delay	t_{pd}	$I_P = I_P(\max)$, $T_A = 25^\circ\text{C}$, $C_L = \text{open}$	–	5	–	μs
Response Time	t_{RESPONSE}	$I_P = I_P(\max)$, $T_A = 25^\circ\text{C}$, $C_L = \text{open}$	–	13	–	μs
Internal Bandwidth	BWi	Small signal –3 dB	–	40	–	kHz
Noise Density	I_{ND}	Input referenced noise density; $T_A = 25^\circ\text{C}$, $C_L = 1\text{ nF}$	–	400	–	$\mu\text{A}_{(\text{rms})}/\sqrt{\text{Hz}}$
Noise	I_N	Input referenced noise; BWi = 40 kHz, $T_A = 25^\circ\text{C}$, $C_L = 1\text{ nF}$	–	80	–	$\text{mA}_{(\text{rms})}$
Nonlinearity	E_{LIN}	Across full range of I_P	–	± 1	–	%
Saturation Voltage ²	V_{OH}	$R_L = R_L(\min)$	$V_{CC} - 0.3$	–	–	V
	V_{OL}	$R_L = R_L(\min)$	–	–	0.3	V
Power-On Time	t_{PO}	Output reaches 90% of steady-state level, $T_A = 25^\circ\text{C}$, $I_P = I_P(\max)$	–	35	–	μs

¹Device may be operated at higher primary current levels, I_P , ambient temperatures, T_A , and internal leadframe temperatures, provided the Maximum Junction Temperature, $T_J(\max)$, is not exceeded.

²The sensor IC will continue to respond to current beyond the range of I_P until the high or low saturation voltage; however, the nonlinearity in this region will be worse than through the rest of the measurement range.

xKMATR-10B PERFORMANCE CHARACTERISTICS: valid at $T_A = -40^\circ\text{C}$ to 125°C , $V_{CC} = 3.3\text{ V}$, unless otherwise specified

Characteristic	Symbol	Test Conditions	Min.	Typ. ¹	Max.	Units
Nominal Performance						
Current Sensing Range	I_{PR}		-10	-	10	A
Sensitivity	Sens	$I_{PR(\text{min})} < I_P < I_{PR(\text{max})}$	-	132	-	mV/A
Zero Current Output Voltage	$V_{IOUT(Q)}$	Bidirectional; $I_P = 0\text{ A}$	-	$V_{CC} \times 0.5$	-	V
Accuracy Performance						
Total Output Error ²	E_{TOT}	$I_P = I_{PR(\text{max})}$; $T_A = 25^\circ\text{C}$	-5	-1 \pm 2	5	%
		$I_P = I_{PR(\text{max})}$; $T_A = 85^\circ\text{C}$	-	-2 \pm 2	-	
		$I_P = I_{PR(\text{max})}$; $T_A = 125^\circ\text{C}$	-	-1 \pm 3	-	
		$I_P = I_{PR(\text{max})}$; $T_A = -40^\circ\text{C}$	-	1 \pm 3	-	
Total Output Error Components³ $E_{TOT} = E_{SENS} + 100 \times V_{OE} / (\text{Sens} \times I_P)$						
Sensitivity Error	E_{SENS}	$T_A = 25^\circ\text{C}$; measured at $I_P = I_{PR(\text{max})}$	-4	-1 \pm 2	4	%
		$T_A = 85^\circ\text{C}$; measured at $I_P = I_{PR(\text{max})}$	-	-1.5 \pm 2	-	
		$T_A = 125^\circ\text{C}$; measured at $I_P = I_{PR(\text{max})}$	-	-1 \pm 3	-	
		$T_A = -40^\circ\text{C}$; measured at $I_P = I_{PR(\text{max})}$	-	1 \pm 3	-	
Offset Voltage ⁴	V_{OE}	$T_A = 25^\circ\text{C}$; $I_P = 0\text{ A}$;	-40	\pm 10	40	mV
		$T_A = 85^\circ\text{C}$; $I_P = 0\text{ A}$;	-	\pm 15	-	
		$T_A = 125^\circ\text{C}$; $I_P = 0\text{ A}$;	-	-5 \pm 20	-	
		$T_A = -40^\circ\text{C}$; $I_P = 0\text{ A}$	-	10 \pm 20	-	
Lifetime Drift Characteristics						
Sensitivity Error Lifetime Drift	E_{SENS_DRIFT}		-	\pm 2	-	%
Total Output Error Lifetime Drift	E_{TOT_DRIFT}		-	\pm 2	-	%

¹ Typical values with \pm are 3 sigma values.

² Percentage of I_P , with $I_P = I_{PR(\text{max})}$.

³ A single part will not have both the maximum/minimum sensitivity error and maximum/minimum offset voltage, as that would violate the maximum/minimum total output error specification. Also, 3 sigma distribution values are combined by taking the square root of the sum of the squares. See Application Information section.

⁴ Offset Voltage does not incorporate any error due to external magnetic fields. See section: Impact of External Magnetic Fields.

xKMATR-20B PERFORMANCE CHARACTERISTICS: valid at $T_A = -40^\circ\text{C}$ to 125°C , $V_{CC} = 3.3\text{ V}$, unless otherwise specified

Characteristic	Symbol	Test Conditions	Min.	Typ. ¹	Max.	Units
Nominal Performance						
Current Sensing Range	I_{PR}		-20	-	20	A
Sensitivity	Sens	$I_{PR}(\text{min}) < I_P < I_{PR}(\text{max})$	-	66	-	mV/A
Zero Current Output Voltage	$V_{IOUT(Q)}$	Bidirectional; $I_P = 0\text{ A}$	-	$V_{CC} \times 0.5$	-	V
Accuracy Performance						
Total Output Error ²	E_{TOT}	$I_P = I_{PR}(\text{max}); T_A = 25^\circ\text{C}$	-5	± 2	5	%
		$I_P = I_{PR}(\text{max}); T_A = 85^\circ\text{C}$	-	± 2	-	
		$I_P = I_{PR}(\text{max}); T_A = 125^\circ\text{C}$	-	± 2	-	
		$I_P = I_{PR}(\text{max}); T_A = -40^\circ\text{C}$	-	2 ± 2	-	
Total Output Error Components³ $E_{TOT} = E_{SENS} + 100 \times V_{OE} / (\text{Sens} \times I_P)$						
Sensitivity Error	E_{SENS}	$T_A = 25^\circ\text{C}$; measured at $I_P = I_{PR}(\text{max})$	-4	± 2	4	%
		$T_A = 85^\circ\text{C}$; measured at $I_P = I_{PR}(\text{max})$	-	± 2	-	
		$T_A = 125^\circ\text{C}$; measured at $I_P = I_{PR}(\text{max})$	-	± 2	-	
		$T_A = -40^\circ\text{C}$; measured at $I_P = I_{PR}(\text{max})$	-	1.5 ± 2	-	
Offset Voltage ⁴	V_{OE}	$T_A = 25^\circ\text{C}$; $I_P = 0\text{ A}$;	-40	± 5	40	mV
		$T_A = 85^\circ\text{C}$; $I_P = 0\text{ A}$;	-	± 10	-	
		$T_A = 125^\circ\text{C}$; $I_P = 0\text{ A}$;	-	-5 ± 15	-	
		$T_A = -40^\circ\text{C}$; $I_P = 0\text{ A}$	-	5 ± 10	-	
Lifetime Drift Characteristics						
Sensitivity Error Lifetime Drift	E_{SENS_DRIFT}		-	± 2	-	%
Total Output Error Lifetime Drift	E_{TOT_DRIFT}		-	± 2	-	%

¹ Typical values with \pm are 3 sigma values.

² Percentage of I_P , with $I_P = I_{PR}(\text{max})$.

³ A single part will not have both the maximum/minimum sensitivity error and maximum/minimum offset voltage, as that would violate the maximum/minimum total output error specification. Also, 3 sigma distribution values are combined by taking the square root of the sum of the squares. See Application Information section.

⁴ Offset Voltage does not incorporate any error due to external magnetic fields. See section: Impact of External Magnetic Fields.

CHARACTERISTIC PERFORMANCE

xKMATR-10B Key Parameters

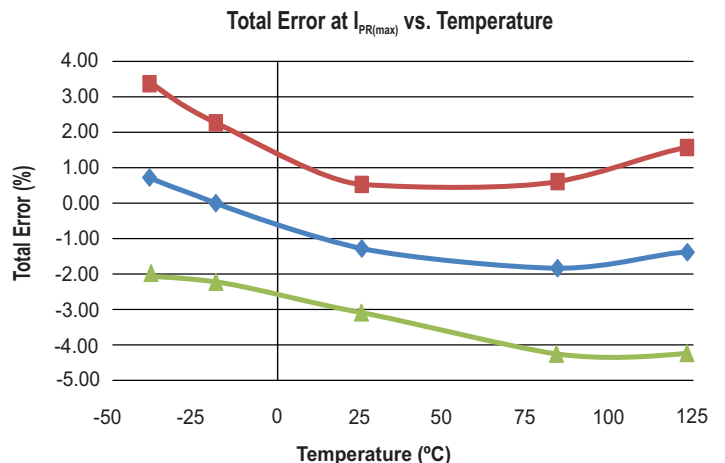
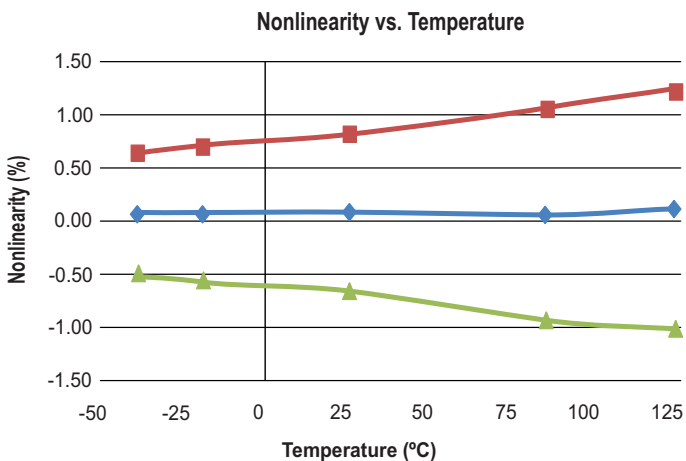
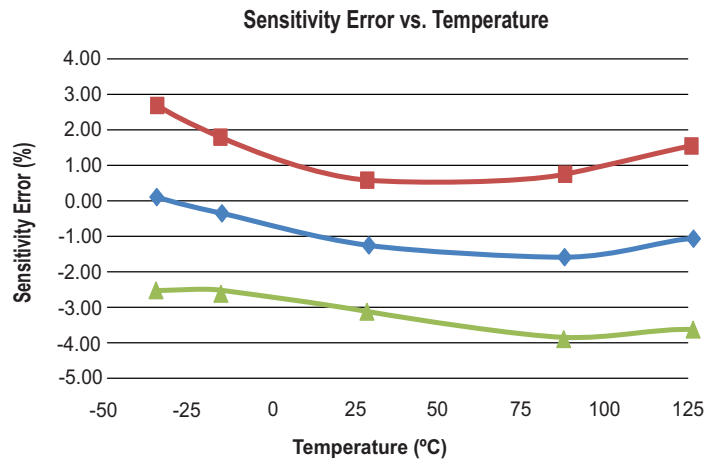
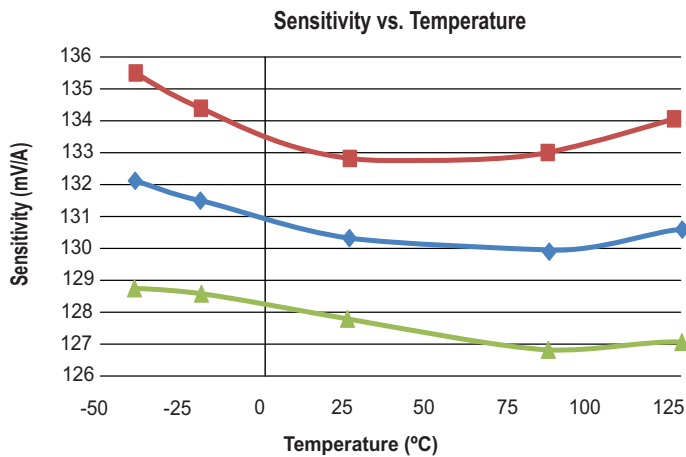
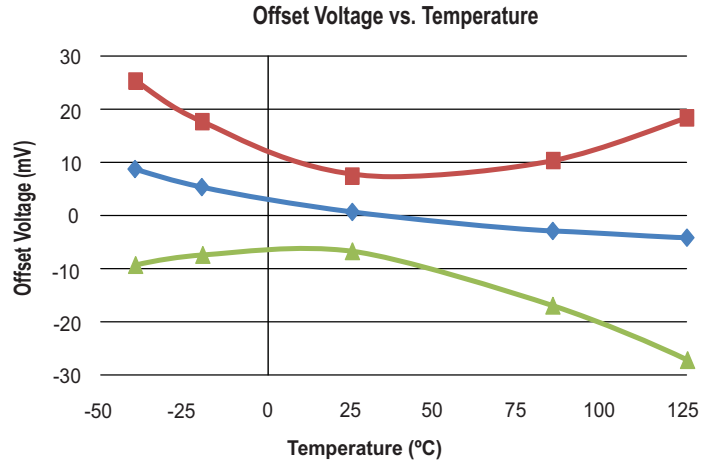
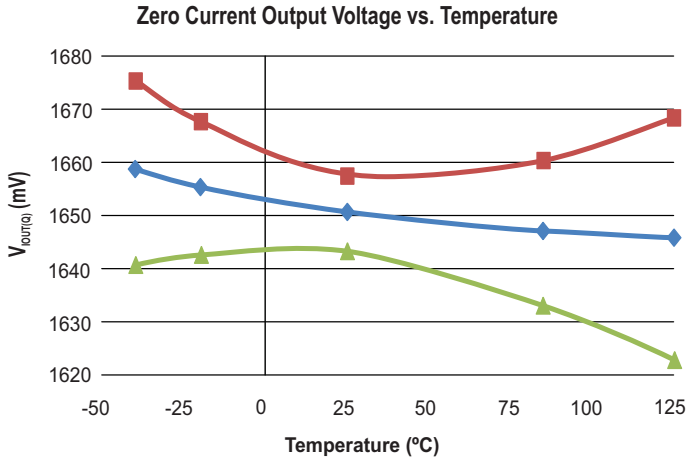

—■— +3 Sigma

—◆— Average

—▲— -3 Sigma

xKMATR-20B Key Parameters

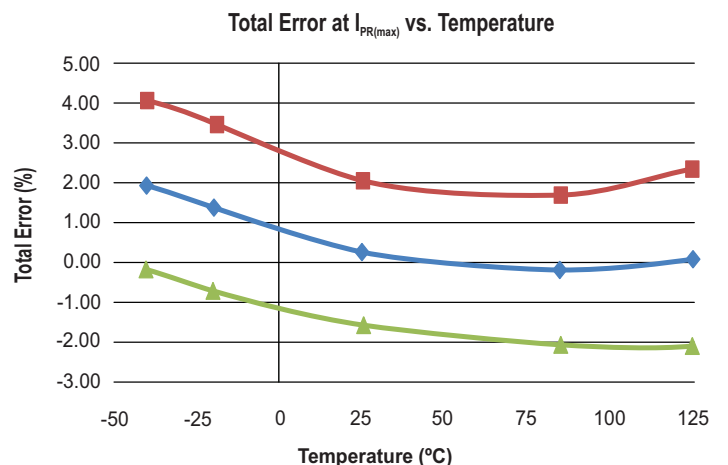
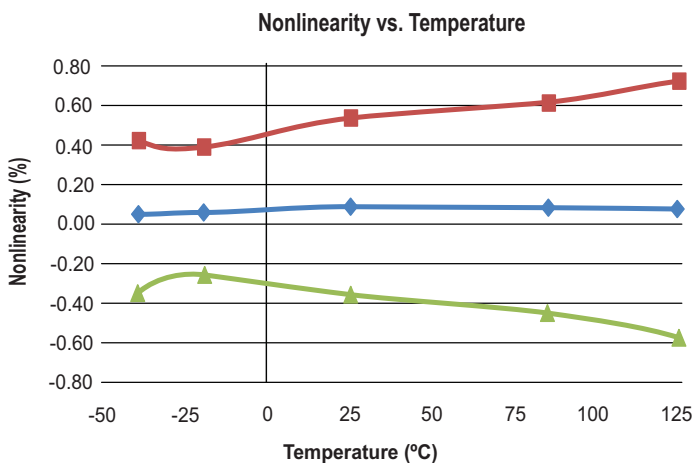
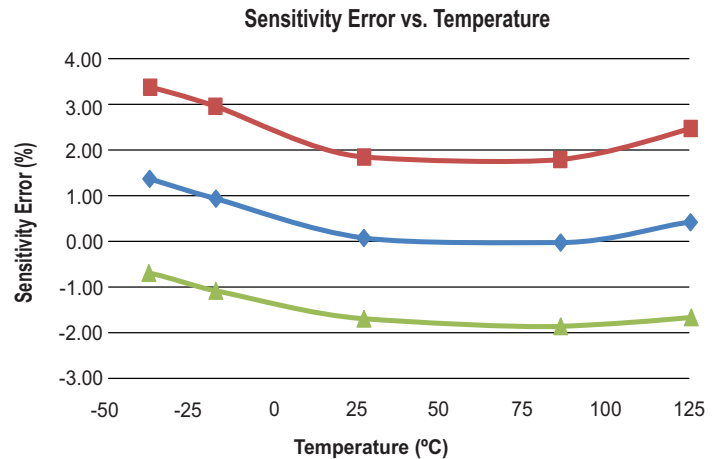
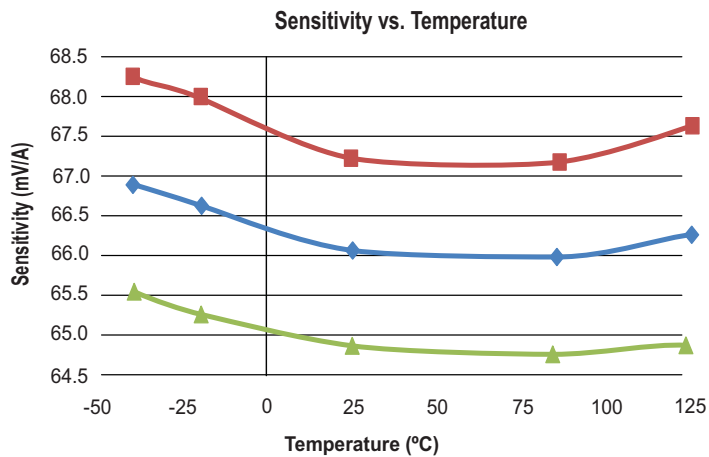
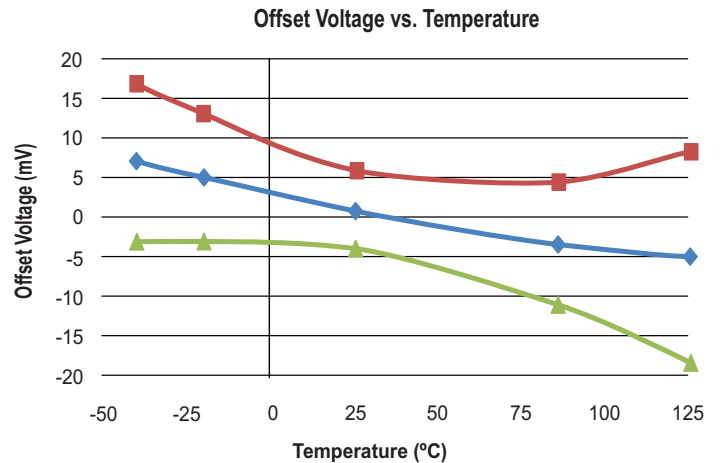
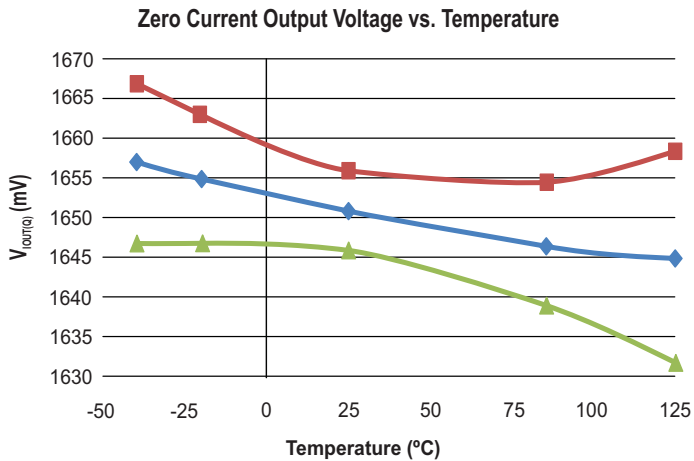

—■— +3 Sigma —◆— Average —▲— -3 Sigma

DEFINITIONS OF ACCURACY CHARACTERISTICS

Sensitivity (Sens). The change in sensor IC output in response to a 1 A change through the primary conductor. The sensitivity is the product of the magnetic circuit sensitivity (G/A) (1 G = 0.1 mT) and the linear IC amplifier gain (mV/G). The linear IC amplifier gain is programmed at the factory to optimize the sensitivity (mV/A) for the full-scale current of the device.

Nonlinearity (E_{LIN}). The nonlinearity is a measure of how linear the output of the sensor IC is over the full current measurement range. The nonlinearity is calculated as:

$$E_{LIN} = \left\{ 1 - \left[\frac{V_{IOUT}(I_{PR(max)}) - V_{IOUT(Q)}}{2 \times V_{IOUT}(I_{PR(max)/2}) - V_{IOUT(Q)}} \right] \right\} \times 100 (\%)$$

where $V_{IOUT}(I_{PR(max)})$ is the output of the sensor IC with the maximum measurement current flowing through it and $V_{IOUT}(I_{PR(max)/2})$ is the output of the sensor IC with half of the maximum measurement current flowing through it.

Zero Current Output Voltage (V_{IOUT(Q)}). The output of the sensor when the primary current is zero. For a unipolar supply voltage, it nominally remains at at $0.5 \times V_{CC}$ for a bidirectional device and $0.1 \times V_{CC}$ for a unidirectional device. For example, in the case of a bidirectional output device, $V_{CC} = 3.3 \text{ V}$ translates into $V_{IOUT(Q)} = 1.65 \text{ V}$. Variation in $V_{IOUT(Q)}$ can be attributed to the resolution of the Allegro linear IC quiescent voltage trim and thermal drift.

Offset Voltage (V_{OE}). The deviation of the device output from its ideal quiescent value of $0.5 \times V_{CC}$ (bidirectional) or $0.1 \times V_{CC}$ (unidirectional) due to nonmagnetic causes. To convert this voltage to amperes, divide by the device sensitivity, Sens.

Total Output Error (E_{TOT}). The the difference between the current measurement from the sensor IC and the actual current (I_P), relative to the actual current. This is equivalent to the difference between the ideal output voltage and the actual output voltage, divided by the ideal sensitivity, relative to the current flowing through the primary conduction path:

$$E_{TOT}(I_P) = \frac{V_{IOUT_ideal}(I_P) - V_{IOUT}(I_P)}{Sens_{ideal}(I_P) \times I_P} \times 100 (\%)$$

The Total Output Error incorporates all sources of error and is a function of I_P. At relatively high currents, E_{TOT} will be mostly due to sensitivity error, and at relatively low currents, E_{TOT} will be mostly due to Offset Voltage (V_{OE}). In fact, at I_P = 0, E_{TOT} approaches infinity due to the offset. This is illustrated in figures 1 and 2. Figure 1 shows a distribution of output voltages versus I_P at 25°C and across temperature. Figure 2 shows the corresponding E_{TOT} versus I_P.

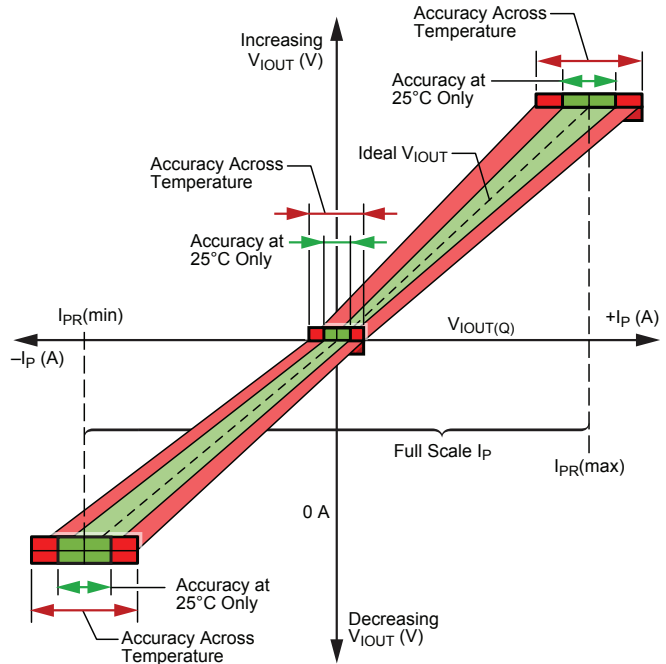

Figure 1: Output Voltage versus Sensed Current

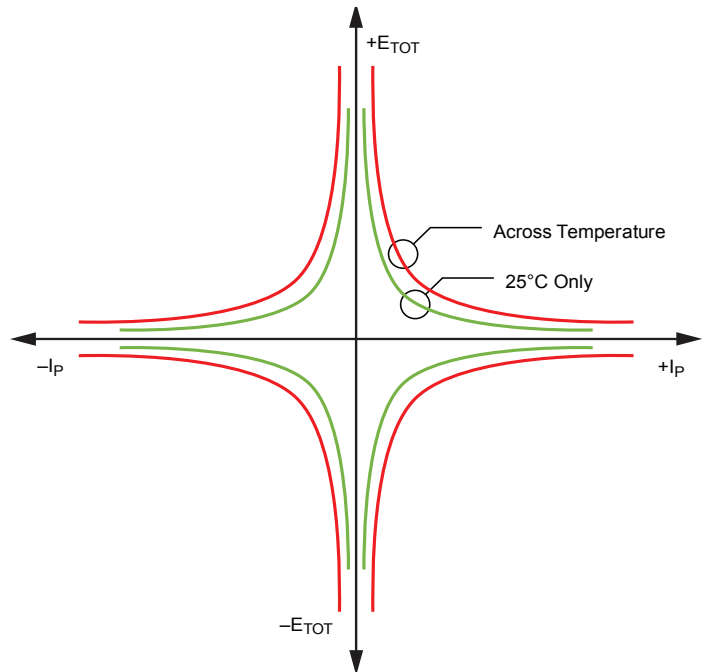

Figure 2: Total Output Error versus Sensed Current

APPLICATION INFORMATION

Impact of External Magnetic Fields

The ACS717 works by sensing the magnetic field created by the current flowing through the package. However, the sensor cannot differentiate between fields created by the current flow and external magnetic fields. This means that external magnetic fields can cause errors in the output of the sensor. Magnetic fields which are perpendicular to the surface of the package affect the output of the sensor, as it only senses fields in that one plane. The error in Amperes can be quantified as:

$$\text{Error}(B) = \frac{B}{C_F}$$

where B is the strength of the external field perpendicular to the surface of the package in Gauss, and C_F is the coupling factor in G/A. Then, multiplying by the sensitivity of the part (Sens) gives the error in mV.

For example, an external field of 1 Gauss will result in around 0.22 A of error. If the ACS717KMATR-10B, which has a nominal sensitivity of 132 mV/A, is being used, that equates to 30 mV of error on the output of the sensor.

Table 1: External Magnetic Field (Gauss) Impact

External Field (Gauss)	Error (A)	Error (mV)	
		10B	20B
0.5	0.11	15	7
1	0.22	30	15
2	0.44	60	30

Estimating Total Error vs. Sensed Current

The Performance Characteristics tables give distribution (±3 sigma) values for Total Error at I_{PR(max)}; however, one often wants to know what error to expect at a particular current. This can be estimated by using the distribution data for the components of Total Error, Sensitivity Error, and Offset Voltage. The

±3 sigma value for Total Error (E_{TOT}) as a function of the sensed current (I_P) is estimated as:

$$E_{TOT}(I_P) = \sqrt{E_{SENS}^2 + \left(\frac{100 \times V_{OE}}{Sens \times I_P}\right)^2}$$

Here, E_{SENS} and V_{OE} are the ±3 sigma values for those error terms. If there is an average sensitivity error or average offset voltage, then the average Total Error is estimated as:

$$E_{TOT,AVG}(I_P) = E_{SENS,AVG} + \frac{100 \times V_{OE,AVG}}{Sens \times I_P}$$

The resulting total error will be a sum of E_{TOT} and E_{TOT,AVG}. Using these equations and the 3 sigma distributions for Sensitivity Error and Offset Voltage, the Total Error vs. sensed current (I_P) is below for the ACS717KMATR-20B. As expected, as one goes towards zero current, the error in percent goes towards infinity due to division by zero (refer to Figure 3).

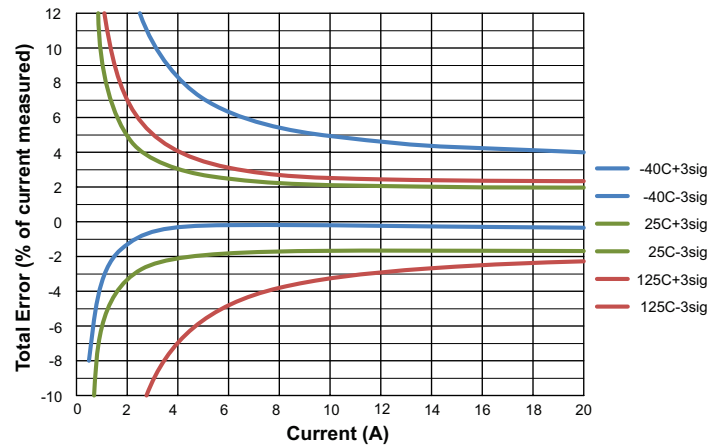

Figure 3: Predicted Total Error as a Function of Sensed Current for the ACS717KMATR-20B

DEFINITIONS OF DYNAMIC RESPONSE CHARACTERISTICS

Power-On Time (t_{PO})

When the supply is ramped to its operating voltage, the device requires a finite time to power its internal components before responding to an input magnetic field.

Power-On Time (t_{PO}) is defined as the time it takes for the output voltage to settle within $\pm 10\%$ of its steady state value under an applied magnetic field, after the power supply has reached its minimum specified operating voltage, $V_{CC(min)}$, as shown in the chart at right.

Rise Time (t_r)

The time interval between a) when the sensor IC reaches 10% of its full scale value, and b) when it reaches 90% of its full scale value.

Propagation Delay (t_{pd})

The propagation delay is measured as the time interval a) when the primary current signal reaches 20% of its final value, and b) when the device reaches 20% of its output corresponding to the applied current.

Response Time ($t_{RESPONSE}$)

The time interval between a) when the primary current signal reaches 90% of its final value, and b) when the device reaches 90% of its output corresponding to the applied current.

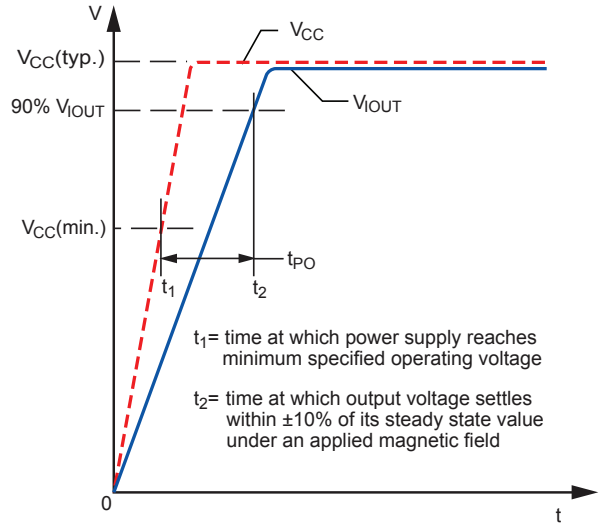

Figure 4: Power-On Time

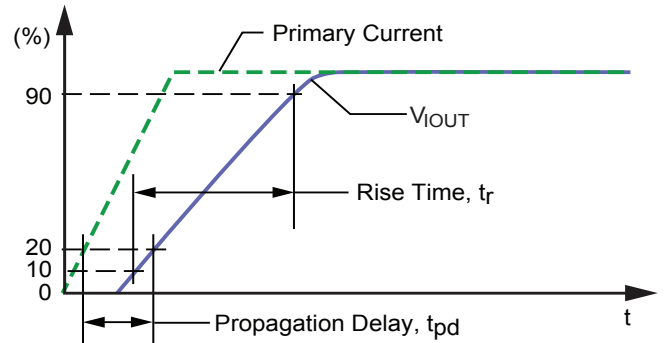

Figure 5: Rise Time and Propagation Delay

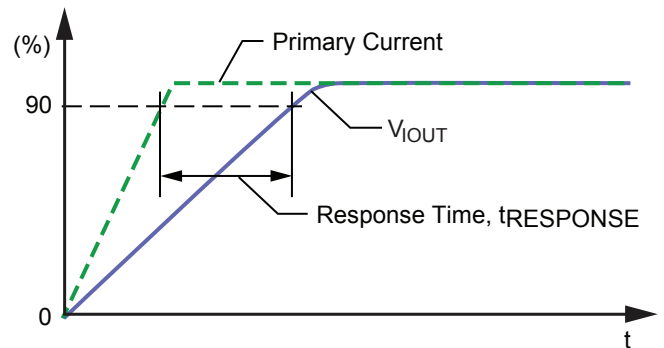
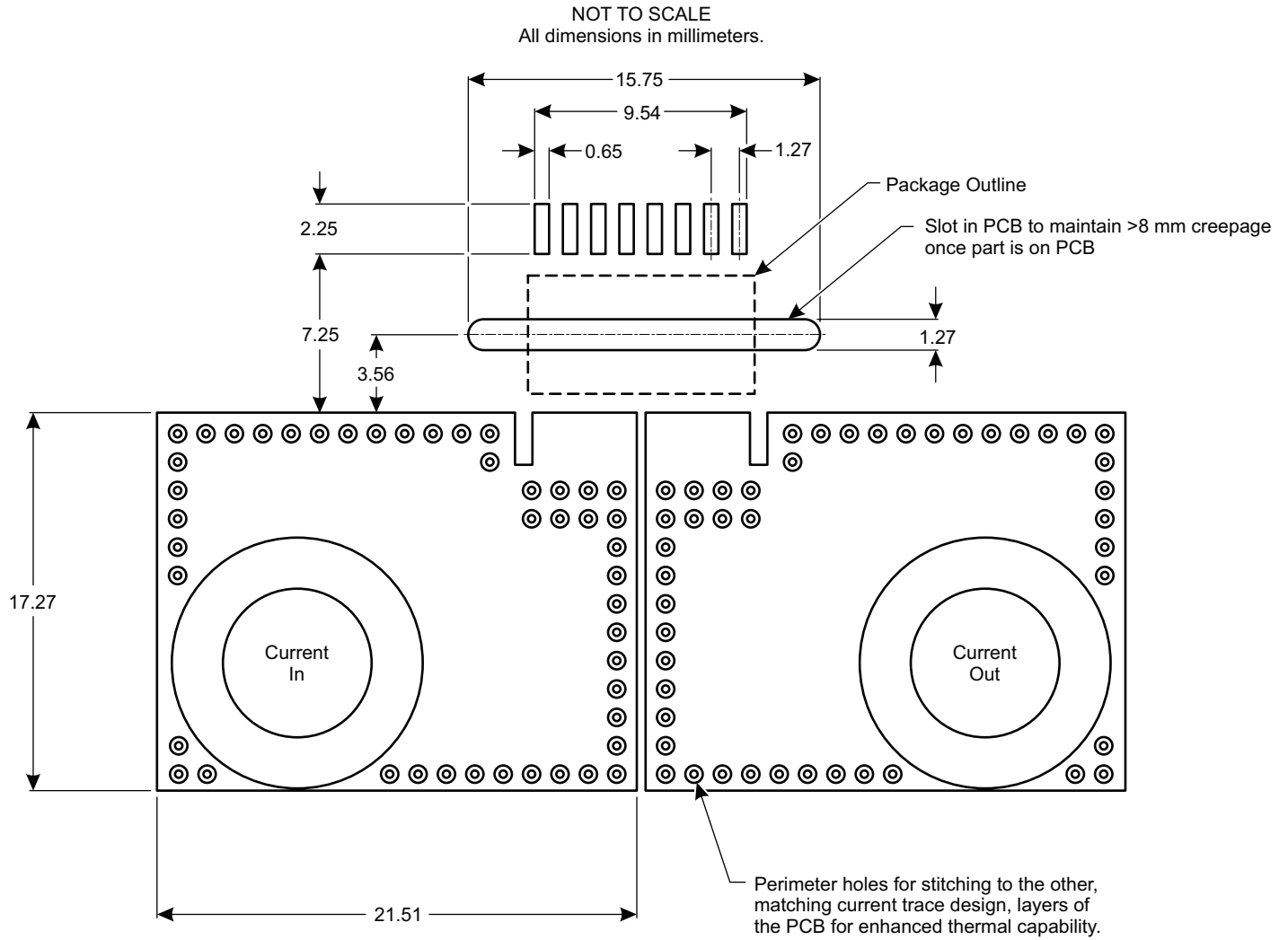

Figure 6: Response Time

HIGH ISOLATION PCB LAYOUT



PACKAGE OUTLINE DRAWING

For Reference Only – Not for Tooling Use

(Reference MS-013AA)

NOT TO SCALE

Dimensions in millimeters

Dimensions exclusive of mold flash, gate burrs, and dambar protrusions

Exact case and lead configuration at supplier discretion within limits shown

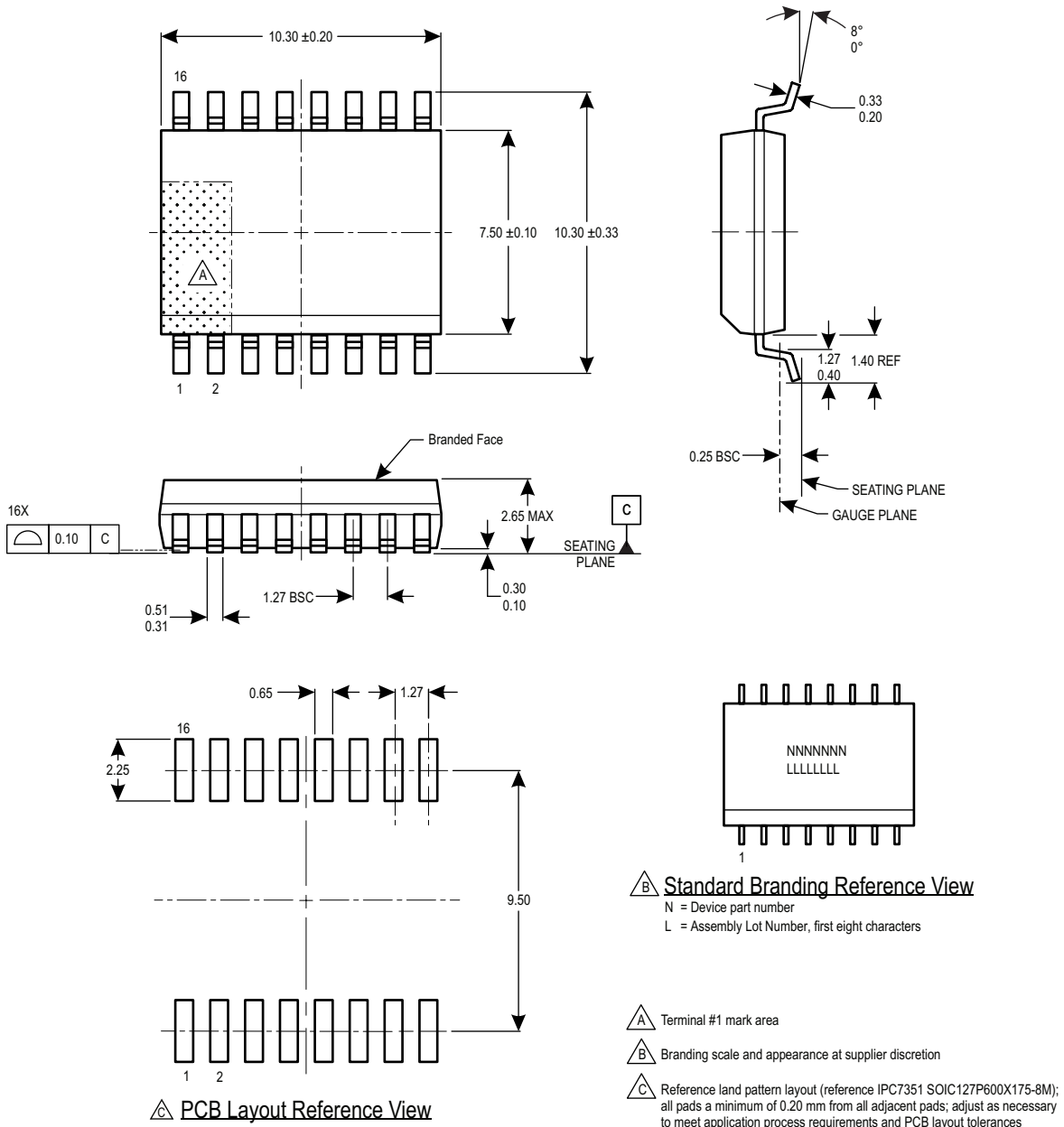

Figure 7: Package MA, 16-Pin SOICW

Revision History

Revision	Revision Date	Description of Revision
–	December 15, 2014	Initial Release
1	April 13, 2016	Corrected Package Outline Drawing branding information (page 13).

Copyright ©2011-2016, Allegro MicroSystems, LLC

Allegro MicroSystems, LLC reserves the right to make, from time to time, such departures from the detail specifications as may be required to permit improvements in the performance, reliability, or manufacturability of its products. Before placing an order, the user is cautioned to verify that the information being relied upon is current.

Allegro's products are not to be used in any devices or systems, including but not limited to life support devices or systems, in which a failure of Allegro's product can reasonably be expected to cause bodily harm.

The information included herein is believed to be accurate and reliable. However, Allegro MicroSystems, LLC assumes no responsibility for its use; nor for any infringement of patents or other rights of third parties which may result from its use.

For the latest version of this document, visit our website:

www.allegromicro.com

