

## GaAs MMIC FUNDAMENTAL MIXER, 26 - 32 GHz



### Typical Applications

The HMC1015 is ideal for:

- Point-to-Point Radios
- Point-to-Multi-Point Radios & VSAT
- Test Equipment & Sensors
- Military End-Use

### Functional Diagram

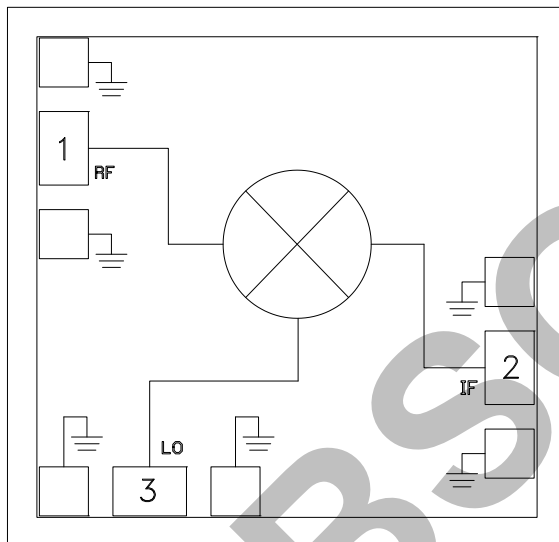

### Features

- Passive: No DC Bias Required
- High Input IP3: 20 dBm
- High LO/RF Isolation: 45 dB
- High 2LO/IF Isolation: 50 dB
- Wide IF Bandwidth: 16 - 22 GHz
- Upconversion & Downconversion Applications
- Die Size: 1.14 x 1.1 x 0.1 mm

### General Description

The HMC1015 is a general purpose triple-balanced mixer chip that can be used as a frequency converter with 16 to 22 GHz at the IF port and 26 to 32 GHz at the RF port. This mixer requires no external components or matching circuitry. The HMC1015 provides excellent LO/RF, LO/IF and 2LO/IF isolation due to optimized balun structures. The mixer operates with LO drive levels from +9 dBm to +15 dBm. The HMC1015 wideband mixer exhibits consistent conversion gain and compression across its bandwidth.

### Electrical Specifications, $T_A = +25^\circ\text{C}$ , LO = 9 GHz, LO = +13 dBm <sup>[2]</sup>

Parameter	Min.	Typ.	Max.	Units
RF Frequency Range		26 - 32		GHz
IF Frequency Range		16 - 22		GHz
LO Frequency Range		7 - 11		GHz
Conversion Loss		10	13	dB
LO to RF Isolation <sup>[1]</sup>		45		dB
LO to IF Isolation <sup>[1]</sup>		31		dB
2LO to IF Isolation <sup>[1]</sup>		50		dB
RF to IF Isolation		35		dB
IP3 (Input)		22		dBm
1 dB Gain Compression (Input)		10		dBm

[1] Fixed IF = 17 GHz.

[2] Unless otherwise noted, all measurements performed as an upconverter with LO = 9 GHz.

**GaAs MMIC FUNDAMENTAL MIXER, 26 - 32 GHz**



**Conversion Gain vs. Temperature Upconverter, LO= 7 GHz**

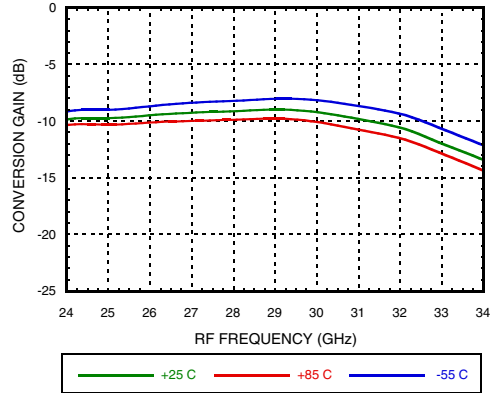

**Conversion Gain vs. Temperature Upconverter, LO= 9 GHz**

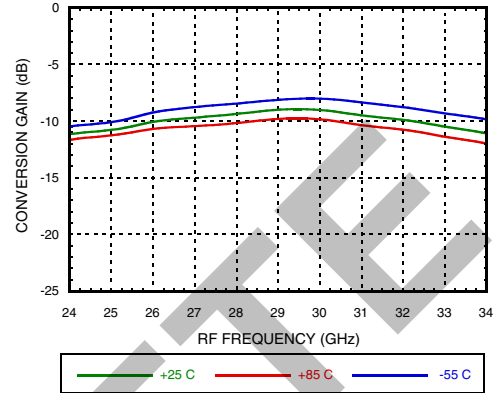

**Conversion Gain vs. Temperature Upconverter, LO= 11 GHz**

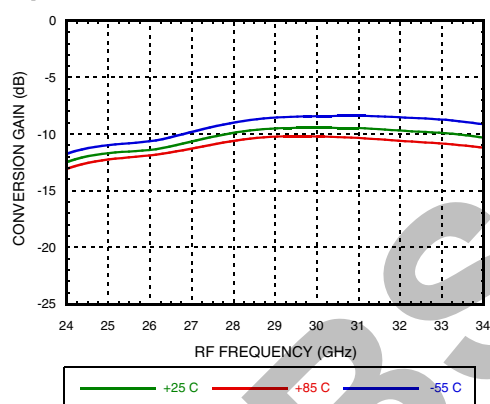

**Conversion Gain vs. LO Power Upconverter, LO= 7 GHz**

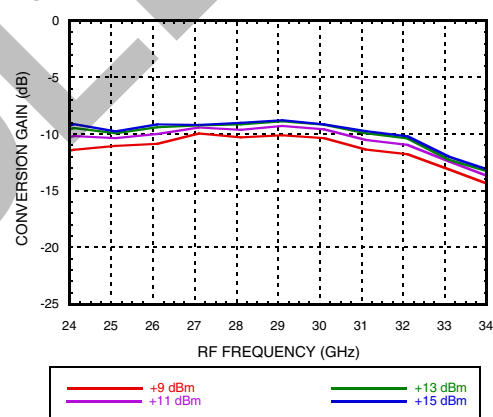

**Conversion Gain vs. LO Power Upconverter, LO= 9 GHz**

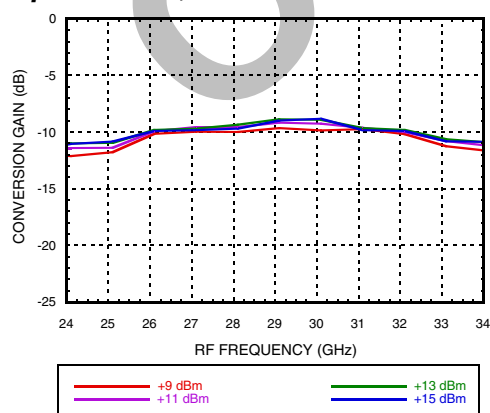

**Conversion Gain vs. LO Power Upconverter, LO= 11 GHz**

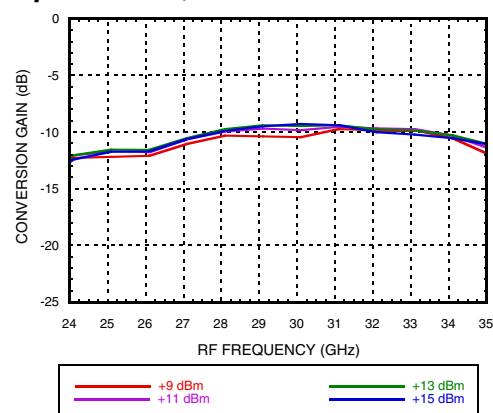

Information furnished by Analog Devices is believed to be accurate and reliable. However, no responsibility is assumed by Analog Devices for its use, nor for any infringements of patents or other rights of third parties that may result from its use. Specifications subject to change without notice. No license is granted by implication or otherwise under any patent or patent rights of Analog Devices. Trademarks and registered trademarks are the property of their respective owners.

For price, delivery, and to place orders: Analog Devices, Inc., One Technology Way, P.O. Box 9106, Norwood, MA 02062-9106 Phone: 781-329-4700 • Order online at [www.analog.com](http://www.analog.com) Application Support: Phone: 1-800-ANALOG-D

**GaAs MMIC FUNDAMENTAL MIXER, 26 - 32 GHz**



MIXERS - TRIPLE-BALANCED - CHIP

**Input IP3 vs. Temperature Upconverter, LO= 7 GHz**

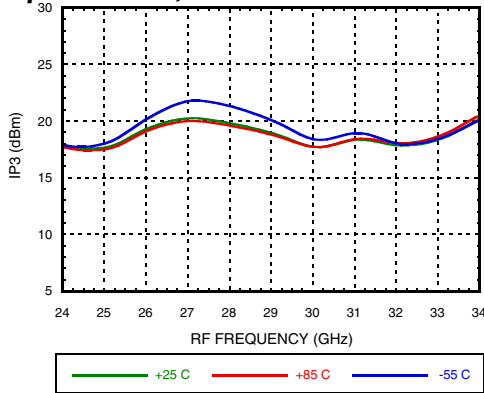

**Input IP3 vs. Temperature Upconverter, LO= 9 GHz**

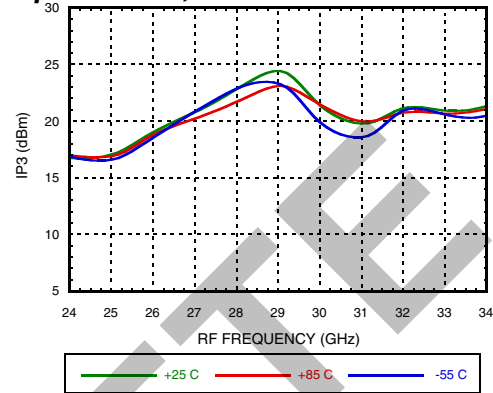

**Input IP3 vs. Temperature Upconverter, LO= 11 GHz**

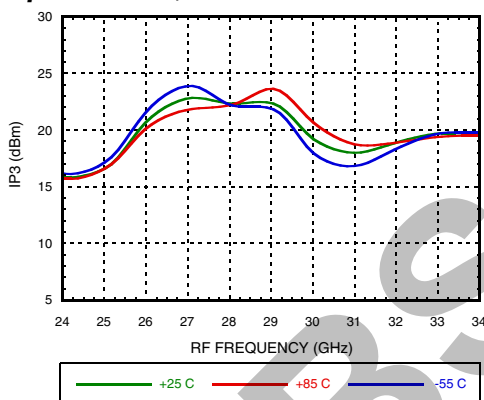

**Input IP3 vs. LO Power Upconverter, LO= 7 GHz**

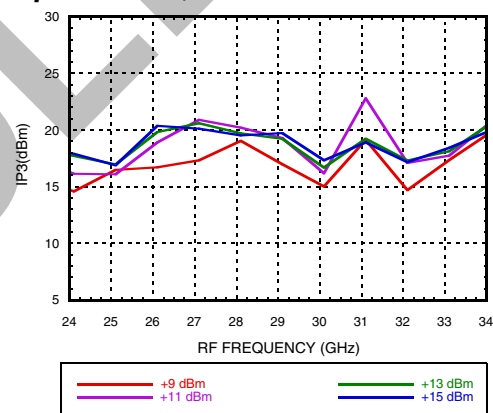

**Input IP3 vs. LO Power Upconverter, LO= 9 GHz**

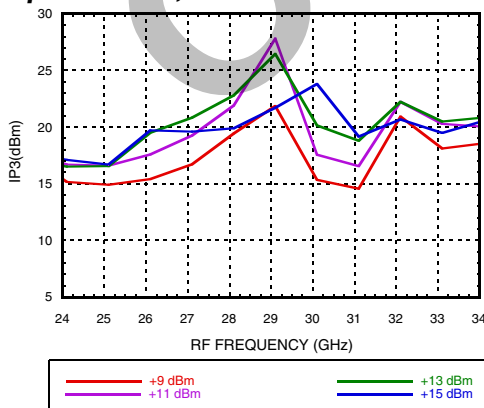

**Input IP3 vs. LO Power Upconverter, LO= 11 GHz**

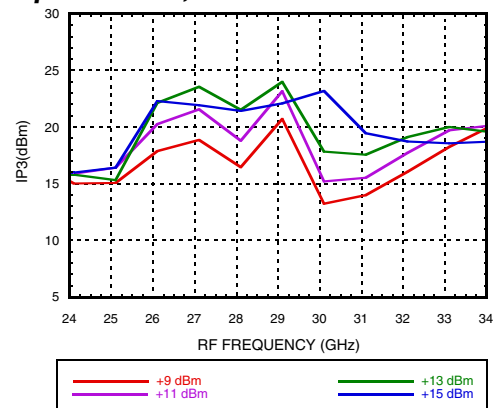

Information furnished by Analog Devices is believed to be accurate and reliable. However, no responsibility is assumed by Analog Devices for its use, nor for any infringements of patents or other rights of third parties that may result from its use. Specifications subject to change without notice. No license is granted by implication or otherwise under any patent or patent rights of Analog Devices. Trademarks and registered trademarks are the property of their respective owners.

For price, delivery, and to place orders: Analog Devices, Inc., One Technology Way, P.O. Box 9106, Norwood, MA 02062-9106 Phone: 781-329-4700 • Order online at [www.analog.com](http://www.analog.com) Application Support: Phone: 1-800-ANALOG-D



**GaAs MMIC FUNDAMENTAL MIXER, 26 - 32 GHz**

**RF and IF Return Loss**

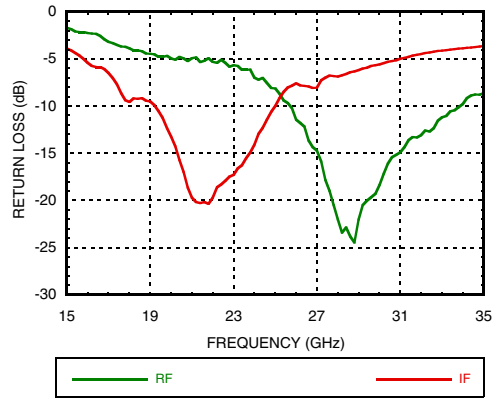

**LO Return Loss**

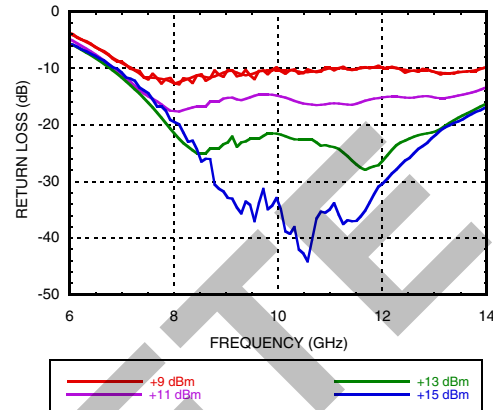

**Isolation LO/IF, LO/RF, 2LO/IF**

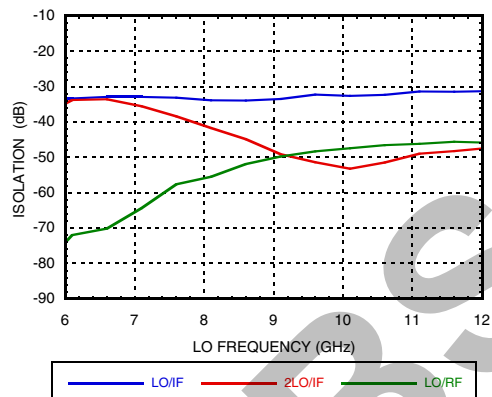

**Isolation RF/IF**

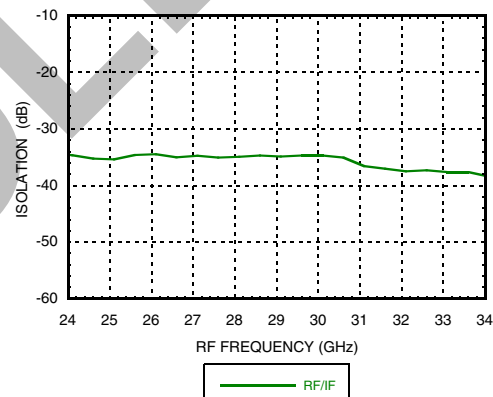

**Input P1dB vs. Temperature @ LO= 9 GHz**

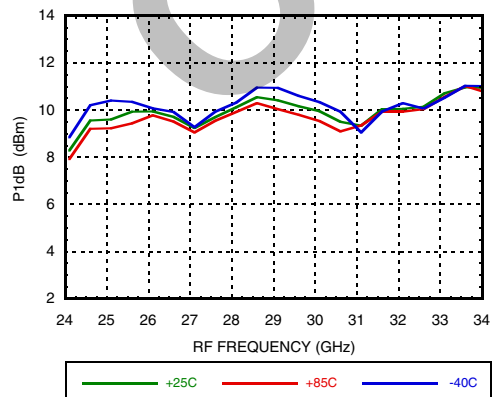

**Input P1dB vs. LO Power @ LO= 9 GHz**

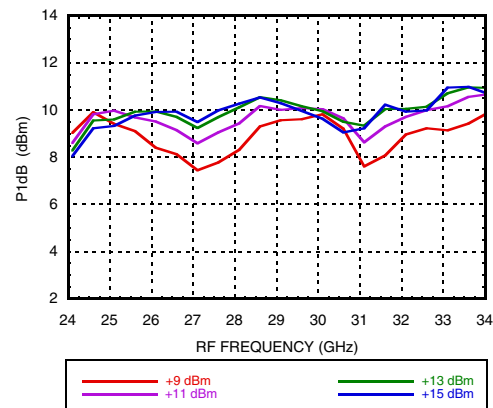

Information furnished by Analog Devices is believed to be accurate and reliable. However, no responsibility is assumed by Analog Devices for its use, nor for any infringements of patents or other rights of third parties that may result from its use. Specifications subject to change without notice. No license is granted by implication or otherwise under any patent or patent rights of Analog Devices. Trademarks and registered trademarks are the property of their respective owners.

For price, delivery, and to place orders: Analog Devices, Inc., One Technology Way, P.O. Box 9106, Norwood, MA 02062-9106 Phone: 781-329-4700 • Order online at [www.analog.com](http://www.analog.com) Application Support: Phone: 1-800-ANALOG-D

**Table 1. Absolute Maximum Ratings**

RF / IF Input (LO = +18 dBm)	15.5 dBm
LO Drive	20 dBm
Maximum Junction Temperature	150 °C
Continuous Pdiss (Ta = 85 °C) (derate 2.5 mW/°C above 85 °C)	79 mW
Thermal Resistance (R <sub>TH</sub> ) (junction to die bottom)	392 °C/W
Operating Temperature	-55°C to +85°C
Storage Temperature	-65°C to 150°C

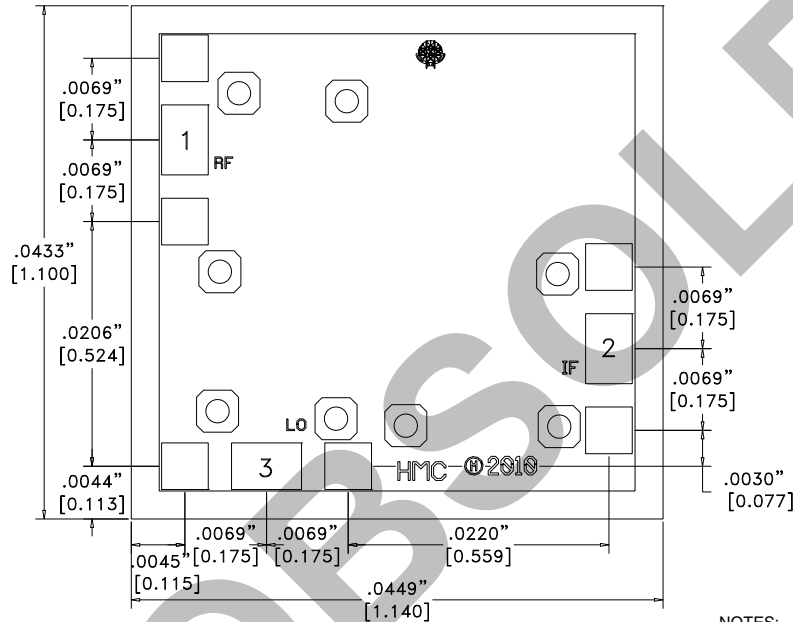

ELECTROSTATIC SENSITIVE DEVICE  
OBSERVE HANDLING PRECAUTIONS

**Outline Drawing**

**NOTES:**

1. ALL DIMENSIONS ARE IN INCHES [MM].
2. DIE THICKNESS IS 0.004"
3. BOND PADS 1, 2 & 3 are 0.0059" [0.150] X 0.0039" [0.099].
4. BACKSIDE METALLIZATION: GOLD.
5. BOND PAD METALLIZATION: GOLD.
6. BACKSIDE METAL IS GROUND.
7. CONNECTION NOT REQUIRED FOR UNLABELED BOND PADS.
8. OVERALL DIE SIZE ± 0.002

**Table 2. Die Packaging Information** <sup>[1]</sup>

Standard	Alternate
GP-1 (Gel Pack)	[2]

[1] For more information refer to the "Packaging information" Document in the Product Support Section of our website.

[2] For alternate packaging information contact Hittite Microwave Corporation.



**GaAs MMIC FUNDAMENTAL  
MIXER, 26 - 32 GHz**

**Table 3. Pad Descriptions**

Pad Number	Function	Description	Pad Schematic
1	RF	This pad is AC coupled and matched to 50 Ohms.	RF
2	IF	This pad is AC coupled and matched to 50 Ohms.	IF
3	LO	This pad is AC coupled and Matched to 50 Ohms.	LO
Die Bottom	GND	Die bottom must be connected to RF/DC ground	

**Assembly Diagram**

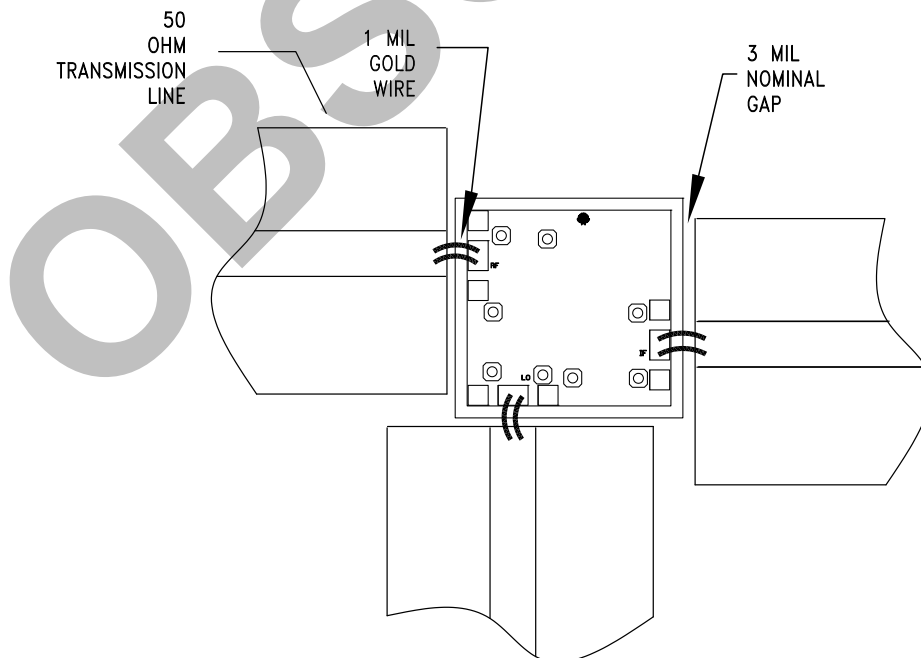

Information furnished by Analog Devices is believed to be accurate and reliable. However, no responsibility is assumed by Analog Devices for its use, nor for any infringements of patents or other rights of third parties that may result from its use. Specifications subject to change without notice. No license is granted by implication or otherwise under any patent or patent rights of Analog Devices. Trademarks and registered trademarks are the property of their respective owners.

For price, delivery, and to place orders: Analog Devices, Inc., One Technology Way, P.O. Box 9106, Norwood, MA 02062-9106 Phone: 781-329-4700 • Order online at [www.analog.com](http://www.analog.com) Application Support: Phone: 1-800-ANALOG-D

## GaAs MMIC FUNDAMENTAL MIXER, 26 - 32 GHz



### Mounting & Bonding Techniques for Millimeterwave GaAs MMICs

The die should be attached directly to the ground plane eutectically or with conductive epoxy (see HMC general Handling, Mounting, Bonding Note).

50 Ohm Microstrip transmission lines on 0.127mm (5 mil) thick alumina thin film substrates are recommended for bringing RF to and from the chip (Figure 1). If 0.254mm (10 mil) thick alumina thin film substrates must be used, the die should be raised 0.150mm (6 mils) so that the surface of the die is coplanar with the surface of the substrate. One way to accomplish this is to attach the 0.102mm (4 mil) thick die to a 0.150mm (6 mil) thick molybdenum heat spreader (moly-tab) which is then attached to the ground plane (Figure 2).

Microstrip substrates should be located as close to the die as possible in order to minimize bond wire length. Typical die-to-substrate spacing is 0.076mm to 0.152 mm (3 to 6 mils).

### Handling Precautions

Follow these precautions to avoid permanent damage.

**Storage:** All bare die are placed in either Waffle or Gel based ESD protective containers, and then sealed in an ESD protective bag for shipment. Once the sealed ESD protective bag has been opened, all die should be stored in a dry nitrogen environment.

**Cleanliness:** Handle the chips in a clean environment. DO NOT attempt to clean the chip using liquid cleaning systems.

**Static Sensitivity:** Follow ESD precautions to protect against ESD strikes.

**Transients:** Suppress instrument and bias supply transients while bias is applied. Use shielded signal and bias cables to minimize inductive pickup.

**General Handling:** Handle the chip along the edges with a vacuum collet or with a sharp pair of bent tweezers. The surface of the chip may have fragile air bridges and should not be touched with vacuum collet, tweezers, or fingers.

### Mounting

The chip is back-metallized and can be die mounted with AuSn eutectic preforms or with electrically conductive epoxy. The mounting surface should be clean and flat.

**Eutectic Die Attach:** A 80/20 gold tin preform is recommended with a work surface temperature of 255 °C and a tool temperature of 265 °C. When hot 90/10 nitrogen/hydrogen gas is applied, tool tip temperature should be 290 °C. DO NOT expose the chip to a temperature greater than 320 °C for more than 20 seconds. No more than 3 seconds of scrubbing should be required for attachment.

**Epoxy Die Attach:** Apply a minimum amount of epoxy to the mounting surface so that a thin epoxy fillet is observed around the perimeter of the chip once it is placed into position. Cure epoxy per the manufacturer's schedule.

### Wire Bonding

Ball or wedge bond with 0.025mm (1 mil) diameter pure gold wire. Thermosonic wirebonding with a nominal stage temperature of 150 °C and a ball bonding force of 40 to 50 grams or wedge bonding force of 18 to 22 grams is recommended. Use the minimum level of ultrasonic energy to achieve reliable wirebonds. Wirebonds should be started on the chip and terminated on the package or substrate. All bonds should be as short as possible <0.31mm (12 mils).

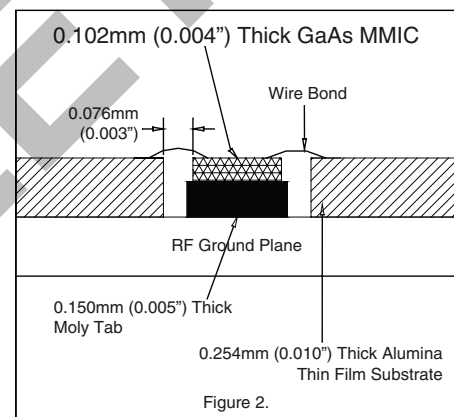
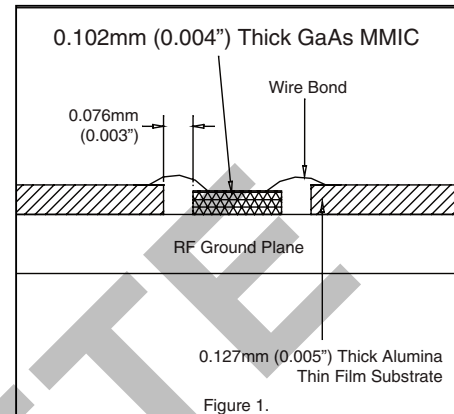



OBSOLETE