

NEW!

Hook Switch



Features/Benefits

- Connect headsets and phones
- Answer and hang up for telephone
- Various lever designs

Typical Applications

- Telecommunication
- Computer peripherals

Specifications

CONTACT ARRANGEMENT: DPDT
 CONTACT RATING: 0.2 A @ 30 VDC
 INITIAL CONTACT RESISTANCE: 50m Ω max.
 INSULATION RESISTANCE: 100M Ω min. @ 500 VDC
 DIELECTRIC STRENGTH: 500 V AC (50-60 Hz)
 OPERATING TEMPERATURE: -20°C to +70°C
 OPERATING FORCE: 50 ± 20 gf

Materials

LEVER: POM (UL94 HB)
 COVER: POM (UL94 HB)
 TERMINAL: Silver plated

NOTE: Specifications and materials listed above are for switches with standard options. For information on specific and custom switches, consult Customer Service Center.

PART NUMBER	LIFE CYCLE	PACKAGING
HS-2206-A1 NS	300,000 cycles	5,000 pieces

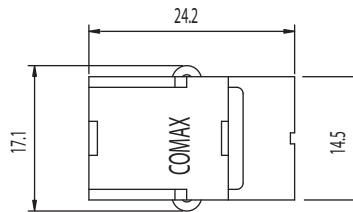

TRAVEL POSITION (X)			
①	③	ON	OFF
②	③	OFF	ON
④	⑥	ON	OFF
⑤	⑥	OFF	ON

6.85 Max 2.65 Min (m/m)

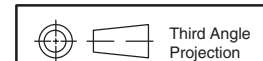
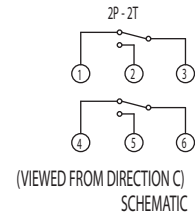
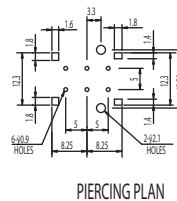
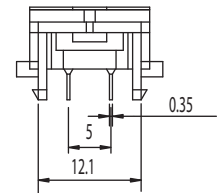
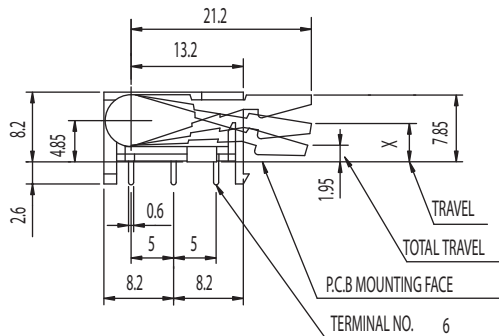

Dimensions are shown: mm
 Specifications and dimensions subject to change

Hook Switch

PART NUMBER	LIFE CYCLE	PACKAGING
HS-2206-D NS	100,000 cycles	5,000 pieces

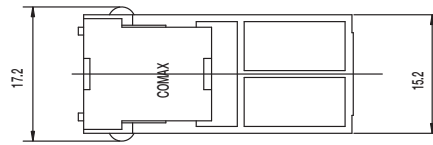

TRAVEL POSITION (X)			
①	③	ON	OFF
②	③	OFF	ON
④	⑥	ON	OFF
⑤	⑥	OFF	ON
		0	1.5Min. 5.2Max. (m/m)

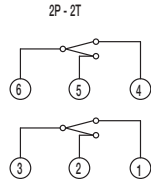
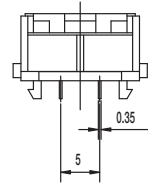
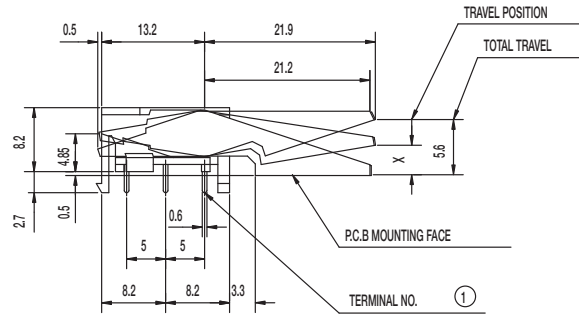

SCHEMATIC

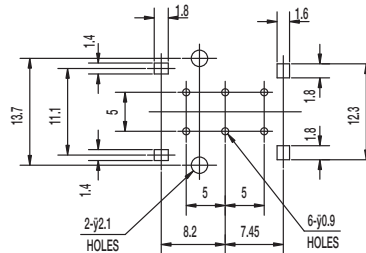

PIERCING PLAN

PART NUMBER	LIFE CYCLE	PACKAGING
HS-2206-E NS	100,000 cycles	5,000 pieces

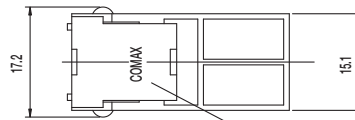

TRAVEL POSITION (X)			
①	③	ON	OFF
②	③	OFF	ON
④	⑥	ON	OFF
⑤	⑥	OFF	ON
		0	1.5Min. 5.9Max. (m/m)

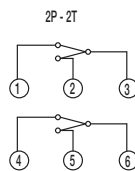
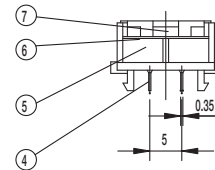
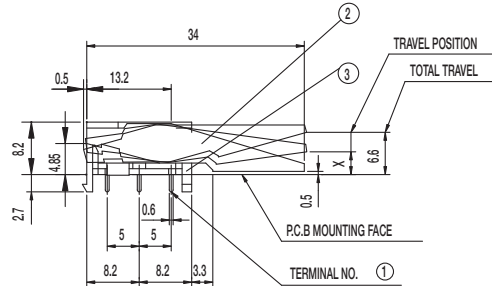

SCHEMATIC

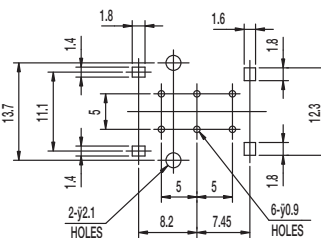

PIERCING PLAN



Dimensions are shown: mm
Specifications and dimensions subject to change