

Description

Single pole thermal circuit breaker with push-to-reset, tease-free, trip-free, snap action mechanism (R type TO CBE to EN 60934). Featuring auxiliary contacts (1 x N/C; 1 x N/O) as standard. Options include an additional unprotected circuit tap (-A3). Approved to CBE standard EN 60934 (IEC 60934).

Typical applications

Motors, transformers, solenoids, controls for oil and gas boilers.

Ordering information

Type No.

2-6400 threadneck panel mounting, with auxiliary contacts

Mounting

iG1 moulded threadneck 3/8-27UNS-2A with hexnut and plastic knurled nut (hardware bulk shipped for 5 pcs plus)

iG2 moulded threadneck M12x1 with hexnut and knurled nut (hardware bulk shipped for 5 pcs plus)

Terminal design - main circuit

L10 solder terminals

P10 blade terminals A6.3-0.8 mm (QC .250)

Shunt terminal (optional)

A3 shunt terminal same as main terminal (up to 7/5 A max. load; up to 16 A/10 A max. load)

Auxiliary contacts

Si N/O and N/C contacts, solder terminals

Current ratings

0.05...16 A

2-6400 - .. - P10 - .. - Si - 8 A ordering example

Please be informed that we have minimum ordering quantities to be observed.

Standard current ratings and typical internal resistance values

Current rating (A)	Internal resistance (Ω)	Current rating (A)	Internal resistance (Ω)
0.05	257	2	0.30
0.08	138	2.5	0.20
0.1	90	3	0.12
0.2	32.2	3,5	0.10
0.3	14.6	4	0.07
0.4	8.4	4.5	0.056
0.5	5.15	5	0.046
0.6	3.82	6	0.035
0.7	2.80	7	0.03
0.8	2.15	8	< 0.02
1	1.42	10	< 0.02
1.2	0.96	12	< 0.02
1.5	0.51	15	< 0.02
1.8	0.40	16	< 0.02



2-6400-...

Technical data

For further details please see: www.e-t-a.de/ti_e

Voltage rating	AC 250 V; DC 28 V	
Current rating range	0.05...16 A	
Auxiliary circuit	1 A, AC 250 V/DC 28 V	
Typical life	0.05...16 A 5,000 operations at 2 x I _N , inductive	
Ambient temperature	-20...+60 °C (-4...+140 °F)	
Insulation co-ordination (IEC 60664 and 60664A)	rated impulse withstand voltage	pollution degree
	2.5 kV	2
	reinforced insulation in operating area	
Dielectric strength (IEC 60664 and 60664A)	test voltage	
	operating area	AC 3,000 V
	main circuit	
	to aux. circuit	AC 1,500 V
	aux. circuit 4-5 to 6-7	AC 840 V
Insulation resistance	> 100 MΩ (DC 500 V)	
Interrupting capacity I _{cn}	10 x I _N	
Interrupting capacity (UL 1077)	I _N	U _N
	0.05...4.5 A	AC 250 V 200 A
	5...8 A	AC 250 V 1,000 A
	8.5...16 A	AC 250 V 2,000 A
Degree of protection (IEC 60529/DIN 40050)	operating area IP40 terminal area IP00	
Vibration	10 g (57-500 Hz) ± 0.76 mm (10-57 Hz), to IEC 60068-2-6, test Fc, 10 frequency cycles/axis	
Shock	40 g (11 ms) to IEC 60068-2-27, test Ea	
Corrosion	96 hours at 5 % salt mist, to IEC 60068-2-11, test Ka	
Humidity	240 hours at 95 % RH to IEC 60068-2-78, test Cab	
Mass	approx. 25 g	

Approvals

Authority	Standard	Rated voltage	Current ratings
VDE	IEC/EN 60934	AC 250 V DC 28 V	0.05 A...16 A 0.05 A...16 A
UL	UL 1077	AC 250 V DC 28 V	0.05 A...16 A 0.05 A...16 A
CSA	C22.2 No 235	AC 250 V DC 28 V	0.05 A...16 A 0.05 A...16 A

Dimensions

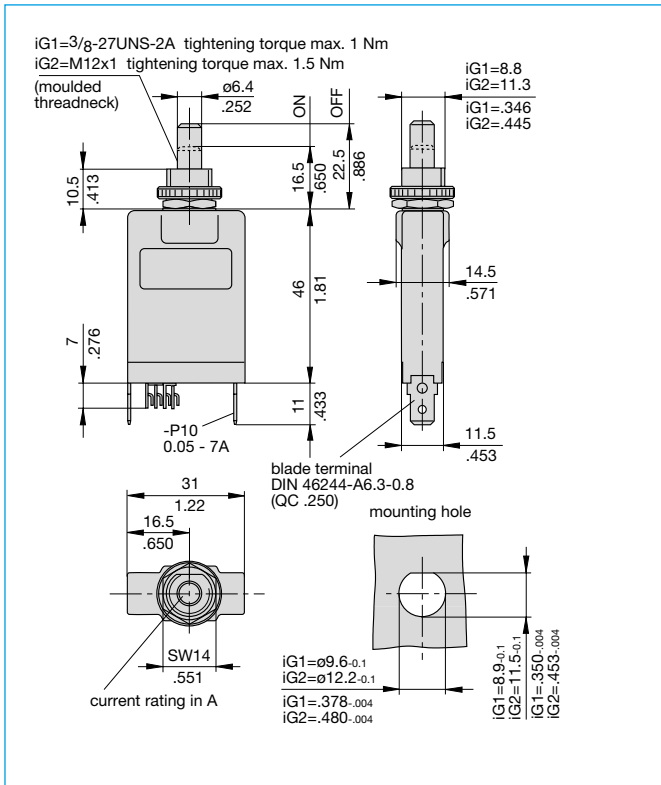

Internal connection diagrams

0.05...7 A

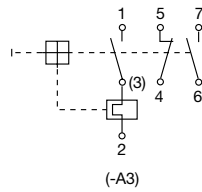

8...16 A

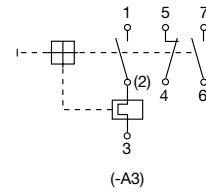

Installation drawing

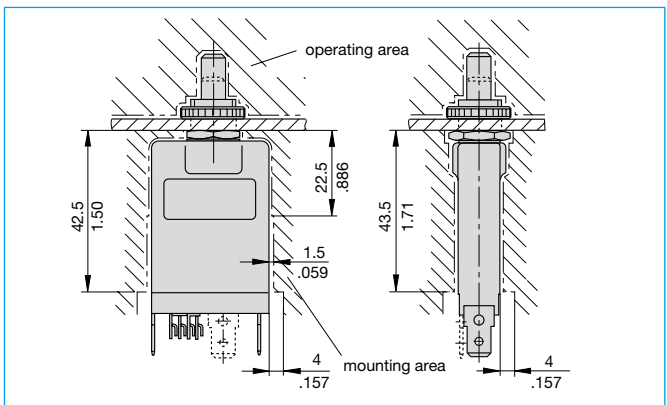

Typical time/current characteristics at +23 °C/+73.4 °F

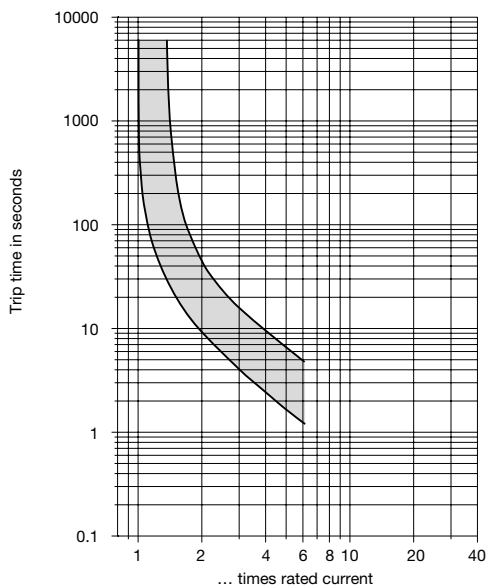

The time/current characteristic curve depends on the ambient temperature prevailing. In order to eliminate nuisance tripping, please multiply the circuit breaker current ratings by the derating factor shown below. See also section Technical information.

Ambient temperature °F	-4	+14	+32	+73.4	+104	+122	+140
°C	-20	-10	0	+23	+40	+50	+60
Derating factor	0.76	0.84	0.92	1	1.08	1.16	1.24

Terminal design

-P10 0.05...7 A

See dimension diagram.

-P10 8...16 A

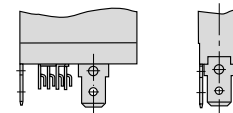

-P10-A3 0.05...16 A

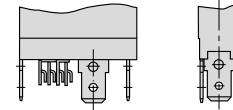

-L10 0.05...7 A

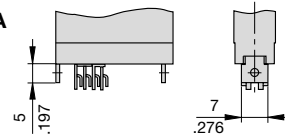

-L10 8...16 A

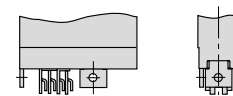

-L10-A3 0.05...16 A

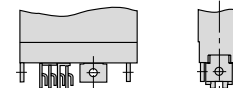

This is a metric design and millimeter dimensions take precedence ($\frac{mm}{inch}$)

Accessories

With 3/8" threadneck (-iG1)

Water splash cover, transparent Y 300 538 01 and knurled nut Y 300 628 01 X 200 799 01 (IP64)

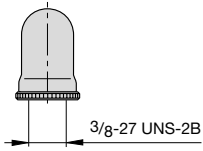

Water splash cover transparent with special knurled nut X 200 798 02 (IP64)

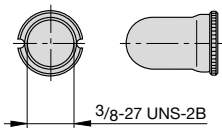

Hex nut with splash cover black without O ring X 210 739 01 (IP64) transparent splash cover X 201 296 03 (IP64)

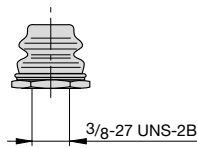

Separate hardware Hex nut Y 300 192 01

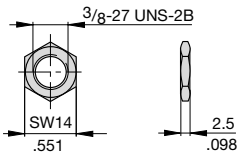

Knurled nut Y 307 117 02

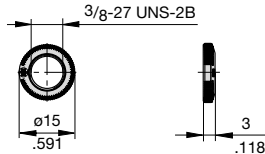

With M12 threadneck (-iG2)

Hex nut with splash cover, black X 201 296 01 without O ring (IP64) X 200 801 03 with O ring (IP66 and IP67) Water splash cover, transparent with knurled nut and O ring X 210 663 01 (IP64)

Hex nut with splash cover, transparent X 200 801 08 with O ring (IP66 and IP67)

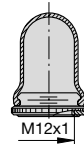

Hex nut Y 300 116 02

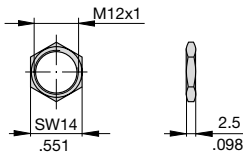

Knurled nut Y 302 065 01

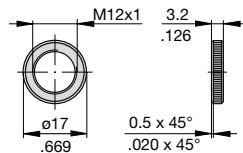

This is a metric design and millimeter dimensions take precedence ($\frac{\text{mm}}{\text{inch}}$)

All dimensions without tolerances are for reference only. In the interest of improved design, performance and cost effectiveness the right to make changes in these specifications without notice is reserved. Product markings may not be exactly as the ordering codes. Errors and omissions excepted.



