

Solid State Relays Industrial, 1-Phase Analog Switching Type RM1E

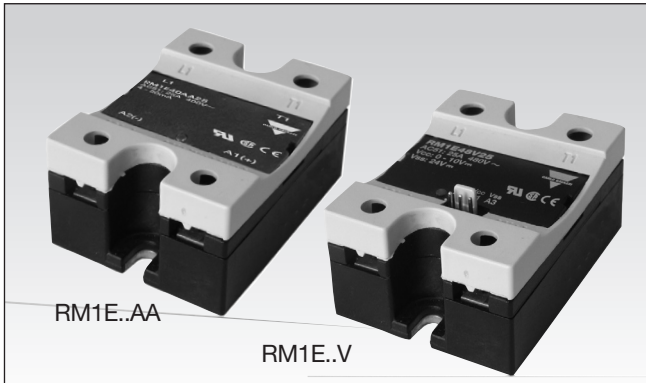

- AC Solid State Relay
- Analog switching (phase-angle control) for resistive and slightly inductive load applications
- 4 - 20mA or 0 -10V control input
- Rated operational current: 25, 50, 75, 100 and 125 AACrms
- Rated operational voltage: Up to 600 VACrms
- Variable intensity LED-indication according to input current
- Integral snubber network
- Polarized lockable control connector for safe connection for voltage controlled version



Product Description

The analog switching relay works in accordance with the phase angle control principle, i.e., the output switching point in the AC sine wave depends on the control input which can be either 4-20mA or 0-10VDC. 4 mA or 0VDC correspond to

zero output power whilst 20 mA or 10VDC correspond to full output power (near linear power response). The relay switches off every time the output current crosses zero, and switches ON in accordance with the applied control input.

Ordering Key

RM 1E 60 AA 50

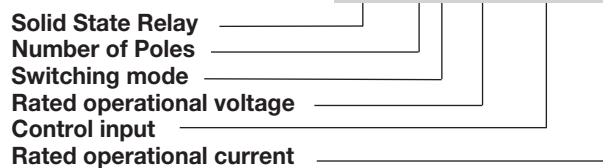

Type Selection

Switching mode	Rated operational voltage	Rated operational current	Control input
E: Analog switching	23: 230 VACrms* 40: 400 VACrms 48: 480 VACrms 60: 600 VACrms	25: 25 AACrms 50: 50 AACrms 75: 75 AACrms 100: 100 AACrms 125: 125 AACrms	AA: 4 - 20 mA DC V: 0-10VDC**

* For nominal operational voltage of 110VACrms, use RM1E23...
** RM1E..V.. require an external supply voltage

Selection Guide

Rated op. voltage	Blocking voltage	Control input	Rated operational current				
			25 A	50 A	75A	100 A	125 A
230 VAC	650 V _p	4 - 20 mA 0-10 VDC	RM1E23AA25 RM1E23V25	RM1E23AA50 RM1E23V50		RM1E23AA100 RM1E23V100	RM1E23AA125 RM1E23V125
400 VAC	850 V _p	4 - 20 mA	RM1E40AA25	RM1E40AA50		RM1E40AA100	
480 VAC	1200 V _p	4 - 20 mA 0-10 VDC	RM1E48AA25 RM1E48V25	RM1E48AA50 RM1E48V50	RM1E48AA75	RM1E48AA100 RM1E48V100	RM1E48AA125 RM1E48V125
600 VAC	1400 V _p	4 - 20 mA 0-10 VDC	RM1E60AA25 RM1E60V25	RM1E60AA50 RM1E60V50		RM1E60AA100 RM1E60V100	

General Specifications

	RM 1E 23 ...	RM 1E 40 ...	RM 1E 48 ...	RM 1E 60 ...
Operational voltage range RM1E..AA.. RM1E..V..	90 to 280 VAC 90 to 265 VAC	340 to 460 VAC -	200 to 550 VAC 200 to 550 VAC	410 to 660 VAC 410 to 660 VAC
Blocking voltage	650 V _p	850 V _p	1200 V _p	1400 V _p
Operational frequency range	45 to 65 Hz	45 to 65 Hz	45 to 65 Hz	45 to 65 Hz
Power factor	> 0.75	> 0.75	> 0.75	> 0.75
Approvals	UR, cUR, CSA, EAC	UR, cUR, CSA, EAC	UR, cUR, CSA, EAC	UR, cUR, CSA, EAC
CE-marking	Yes	Yes	Yes	Yes*

* Heatsink must be connected to ground for 600V types

Output Specifications

	RM1E...25	RM1E...50	RM1E...75	RM1E...100	RM1E...125
Rated operational current					
AC51 Ta=25 °C	25 AACrms	50 AACrms	75 AACrms	100 AACrms	125 AACrms
AC53a Ta=25 °C	5 AACrms	15 AACrms	20 AACrms	20 AACrms	30AACrms
Minimum operational current	150 mA	250 mA	400 mA	400 mA	500 mA
Rep. overload current t=1s	55 AACrms	125 AACrms	150 AACrms	150 AACrms	200 AACrms
Non-rep. surge current t=10ms	325 A _p	600 A _p	1150 A _p	1150 A _p	1900 A _p
Off-state leakage current	< 3 mA	< 3 mA	< 3 mA	< 3 mA	< 3 mA
I ² t for fusing t= 10 ms	525 A ² s	1800 A ² s	6600 A ² s	6600 A ² s	18000 A ² s
Critical dV/dt off-state min.	1000 V/μs	1000 V/μs	1000 V/μs	1000 V/μs	1000 V/μs

Input Specifications

	RM1E..AA..		RM1E..V..
Current controlled input		Voltage controlled input	
Control current range (A1-A2)	4-20 mADC	Supply voltage, V _{ss} (A3-A2)	24 VDC ±20%
Pick up current	4.2 mADC	Max. supply current	15 mA @ 19.2 VDC 20 mA @ 30 VDC
Drop out current	4.1 mADC	Control voltage, V _{cc} (A1-A2)	0-10VDC
Response time (input to output)	≤ 20 ms	Pick up voltage	0.2 VDC
Voltage drop	< 10 VDC @ 20 mA	Drop out voltage	0.1VDC
Dynamic impedance	≥ 330 Ω	Control input current	0.15 mA @10 VDC
Max. allowable input current	50 mA	Response time (input to output)	≤ 20 ms
Reverse polarity protected	Yes	Supply reverse protected	Yes

Note: The use of twisted pair cable for the control input is recommended

Output Power Dissipation

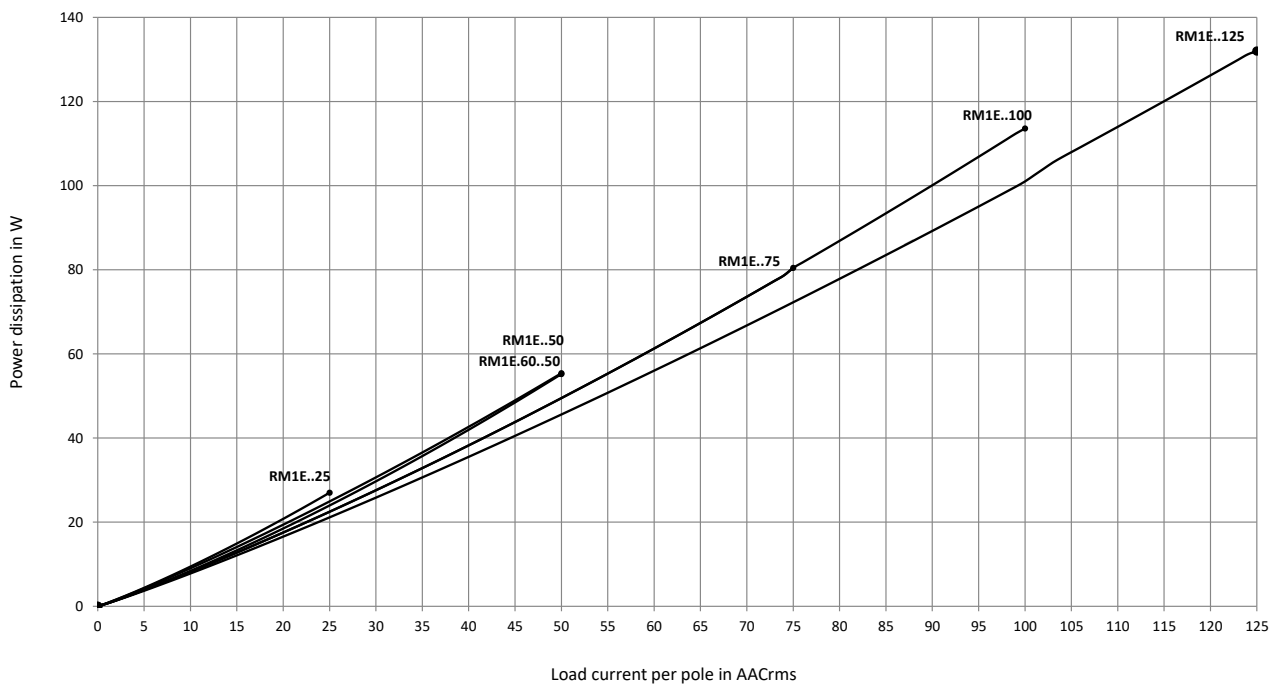



Electromagnetic Compatibility

Immunity	EN60947-4-3	Radiated Radio Frequency	
Electrostatic Discharge (ESD)		Immunity	IEC/EN 61000-4-3
Immunity Air discharge, 8kV Contact, 4kV	IEC/EN 61000-4-2 Performance Criteria 2 Performance Criteria 2	10V/m, 80 - 1000 MHz 10V/m, 1.4 - 2.0GHz 3 V/m, 2.0 - 2.7GHz	Performance Criteria 1 Performance Criteria 1 Performance Criteria 1
Electrical Fast Transient		Conducted Radio Frequency	
(Burst) Immunity Output: 2kV, 5kHz Input: 1kV, 5kHz	IEC/EN 61000-4-4 Performance Criteria 1 Performance Criteria 1	Immunity	IEC/EN 61000-4-6
Electrical Surge Immunity	IEC/EN 61000-4-5	Immunity	Performance Criteria 1
Output, line to line, 1kV Output, line to earth, 1kV Output, line to earth, 2kV	Performance Criteria 2 Performance Criteria 2 Performance Criteria 2	Voltage Dips Immunity	IEC/EN 61000-4-11
Input, line to line, 1kV Input, line to earth, 2kV	Performance Criteria 2 Performance Criteria 2 with external varistor Performance Criteria 2 Performance Criteria 2	0% for 0.5 , 1 cycle 40% for 10 cycles 70% for 25 cycles 80% for 250 cycles	Performance Criteria 2 Performance Criteria 2 Performance Criteria 2 Performance Criteria 2
EMC Emission	EN60947-4-3	Voltage Interruptions Immunity	IEC/EN 61000-4-11
Radio Interference Voltage Emission (Conducted) 0.15 - 30MHz	IEC/EN 55011 Class A (industrial) with filters IEC/EN 60947-4-3 Class A (industrial) with filters	Immunity	Performance Criteria 2
Radio Interference		Immunity	
Field Emission (Radiated)		Immunity	
30 - 1000MHz		Immunity	
		Immunity	
		Immunity	
		Immunity	
		Immunity	
		Immunity	
		Immunity	
		Immunity	
		Immunity	
		Immunity	
		Immunity	
		Immunity	
		Immunity	
		Immunity	
		Immunity	
		Immunity	
		Immunity	
		Immunity	
		Immunity	
		Immunity	
		Immunity	
		Immunity	
		Immunity	
		Immunity	
		Immunity	
		Immunity	
		Immunity	
		Immunity	

Notes:

- Control input lines must be installed together to maintain products' susceptibility to Radio Frequency interference.
- Performance Criteria 1: No degradation of performance or loss of function is allowed when the product is operated as intended.
- Performance Criteria 2: During the test, degradation of performance or partial loss of function is allowed. However, when the test is complete the product should return operating as intended by itself.
- Performance Criteria 3: Temporary loss of function is allowed, provided the function can be restored by manual operation of the controls.

Connection Specifications

Connection terminals	L1, T1	A1, A2			
Stripping length (X)	12 mm	8 mm			
Connection Type	M5 screw with captivated washer	RM1E.AA.: M3 screw with captivated washer RM1E.V.: 3 pins, pitch 2.54mm square pin 0.64" Accessory: RCS3-100-1 terminated cable			
Rigid (solid & stranded) UR rated data		1x 2.5 - 6.0 mm ² 1x 14 - 10 AWG	2x 2.5 - 6.0 mm ² 2x 14 - 10 AWG	1x 0.5 - 2.5 mm ² 1x 18 - 12 AWG	2x 0.5 - 2.5 mm ² 2x 18 - 12 AWG
Flexible with end sleeve		1x 1.0 - 4.0 mm ² 1x 18 - 12 AWG	2x 1.0 - 2.5 mm ² 2x 2.5 - 4.0 mm ² 2x 18 - 14 AWG 2x 14 - 12 AWG	1x 0.5 - 2.5 mm ² 1x 18 - 12 AWG	2x 0.5 - 2.5 mm ² 2x 18 - 12 AWG
Flexible without end sleeve		1x 1.0 - 6.0 mm ² 1x 18 - 10 AWG	2x 1.0 - 2.5 mm ² 2x 2.5 - 6.0 mm ² 2x 18 - 14 AWG 2x 14 - 10 AWG		
Torque specification		Pozidrive 2 2.4 Nm (21.2 lb-in)	Pozidrive 1 0.5 Nm (4.4 lb-in)		
Aperture for termination lug		12 mm	7.5 mm		

Housing Specifications

Weight	
25 A, 50 A	Approx. 60 g
75 A, 100 A, 125 A	Approx. 100 g
Housing material	Noryl, black
Baseplate	
25 A, 50 A	Aluminium
75 A, 100 A, 125 A	Copper, nickel-plated
Relay	
Mounting screws	M5
Mounting torque	1.5-2.0 Nm

Functional Diagram

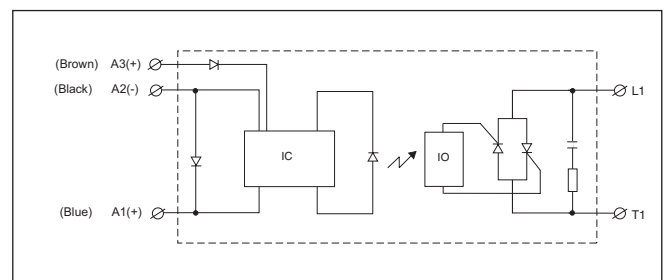
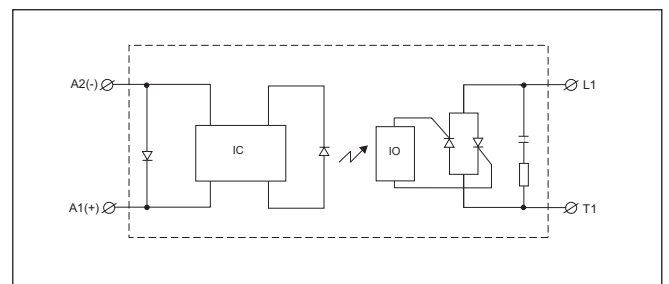



Thermal Specifications

Operating temperature	-20° to +70°C	(4° to +158 °F)
Storage temperature	-20° to +100°C	(-4° to +212 °F)
Junction temperature	≤125°C	(257 °F)

Isolation

Rated isolation voltage	
Input to output	≥ 4000 Vrms
Output to case	≥ 4000 Vrms

Heatsink Dimensions (load current versus ambient temperature)

With the output fully ON (360° conduction angle)

RM1E..25

Load current [A]	Thermal resistance [°C/W]					
	20	30	40	50	60	70
25.0	3.23	2.80	2.37	1.94	1.51	1.09
22.5	3.70	3.21	2.73	2.24	1.75	1.26
20.0	4.30	3.74	3.17	2.61	2.05	1.49
17.5	5.07	4.41	3.76	3.10	2.44	1.78
15.0	6.12	5.33	4.54	3.75	2.96	2.17
12.5	7.58	6.61	5.64	4.66	3.69	2.72
10.0	9.80	7.19	6.14	5.08	4.02	2.97
7.5	13.5	11.80	10.09	8.37	6.66	4.94
5.0	-	18.3	15.7	13.04	10.39	7.74
2.5	-	-	-	-	-	7

Ambient temp. [°C]

RM1E..50

Load current [A]	Thermal resistance [°C/W]					
	20	30	40	50	60	70
50.0	1.25	1.07	0.88	0.70	0.52	0.34
45.0	1.46	1.25	1.04	0.84	0.63	0.42
40.0	1.73	1.49	1.25	1.01	0.77	0.52
35.0	2.08	1.80	1.51	1.23	0.94	0.66
30.0	2.56	2.22	1.87	1.53	1.18	0.84
25.0	3.24	2.81	2.38	1.95	1.52	1.09
20.0	4.26	3.71	3.15	2.59	2.03	1.47
15.0	5.99	5.22	4.45	3.67	2.90	2.12
10.0	9.49	8.27	7.06	5.85	4.64	3.43
5.0	-	17.5	15.0	12.4	9.91	7.39

Ambient temp. [°C]

RM1.60..50

Load current [A]	Thermal resistance [°C/W]					
	20	30	40	50	60	70
50.0	0.99	0.81	0.63	0.44	0.26	0.08
45.0	1.28	1.07	0.86	0.65	0.44	0.23
40.0	1.64	1.40	1.15	0.91	0.67	0.42
35.0	2.11	1.82	1.54	1.25	0.96	0.67
30.0	2.60	2.25	1.90	1.55	1.20	0.85
25.0	3.30	2.86	2.43	1.99	1.55	1.11
20.0	4.36	3.79	3.22	2.65	2.08	1.51
15.0	6.1	5.4	4.6	3.77	2.97	2.18
10.0	9.76	8.52	7.3	6.0	4.8	3.54
5.0	--	--	15.47	12.85	10.24	7.6

Ambient temp. [°C]

RM1E...75

Load current [A]	Thermal resistance [°C/W]					
	20	30	40	50	60	70
75.0	1.00	0.88	0.75	0.63	0.50	0.38
67.5	1.15	1.00	0.86	0.72	0.57	0.43
60.0	1.33	1.16	1.00	0.83	0.66	0.50
52.5	1.56	1.37	1.17	0.98	0.78	0.59
45.0	1.88	1.65	1.41	1.18	0.94	0.71
37.5	2.33	2.04	1.75	1.46	1.17	0.87
30.0	3.01	2.64	2.26	1.88	1.51	1.13
22.5	4.16	3.64	3.12	2.60	2.08	1.56
15.0	6.46	5.66	4.85	4.04	3.23	2.42
7.5	13.42	11.74	10.06	8.39	6.71	5.03

Ambient temp. [°C]

Heatsink Dimensions (load current versus ambient temperature)

RM1E..100

Load current [A]	Thermal resistance [°C/W]					
	20	30	40	50	60	70
100.0	0.60	0.52	0.43	0.34	0.26	0.17
90.0	0.74	0.64	0.54	0.44	0.34	0.24
80.0	0.91	0.79	0.68	0.56	0.45	0.33
70.0	1.09	0.96	0.82	0.68	0.55	0.41
60.0	1.33	1.16	1.00	0.83	0.66	0.50
50.0	1.66	1.45	1.24	1.04	0.83	0.62
40.0	2.16	1.89	1.62	1.35	1.08	0.81
30.0	3.01	2.64	2.26	1.88	1.51	1.13
20.0	4.73	4.14	3.55	2.96	2.37	1.78
10.0	9.94	8.70	7.45	6.21	4.97	3.73

Ambient temp. [°C] T_A

RM1E..125

Load current [A]	Thermal resistance [°C/W]					
	20	30	40	50	60	70
125.0	0.63	0.55	0.47	0.40	0.32	0.24
112.5	0.73	0.64	0.54	0.45	0.36	0.27
100.0	0.84	0.74	0.63	0.52	0.42	0.32
87.5	0.99	0.87	0.74	0.62	0.50	0.37
75.0	1.20	1.05	0.90	0.75	0.60	0.45
62.5	1.48	1.30	1.11	0.93	0.74	0.56
50.0	1.92	1.68	1.44	1.20	0.96	0.72
37.5	2.65	2.32	1.98	1.65	1.32	0.99
25.0	4.12	3.60	3.09	2.57	2.06	1.54
12.5	8.55	7.48	6.41	5.34	4.27	3.21

Ambient temp. [°C] T_A

Dimensions

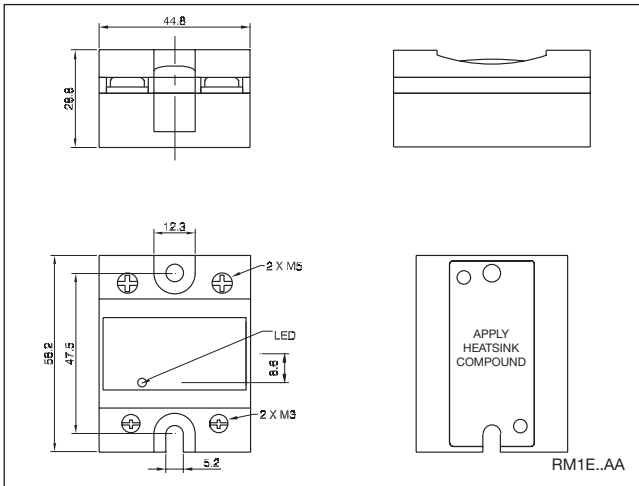

All dimensions in mm

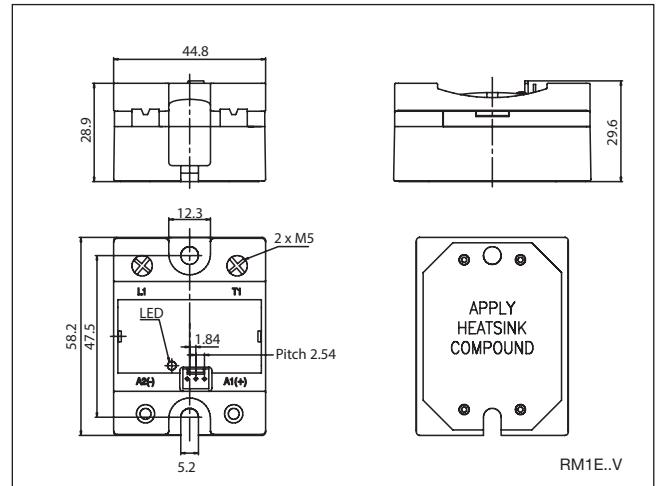

All dimensions in mm

Applications

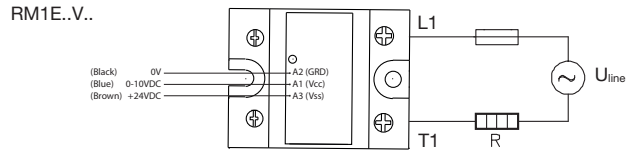
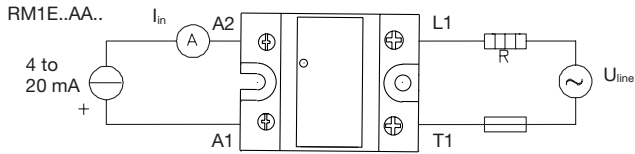

Transfer Characteristics

Output power as a function of control output

Control current (mA)	Control voltage (VDC)	Output power
4	0	0
8	2.5	25
12	5	50
16	7.5	75
20	10	99

This relay is suitable for control of heaters, lighting and slightly inductive loads such as small fans. The relay can also be used for soft turn-on of high-power incandescent lamps.

Heatsink Selection

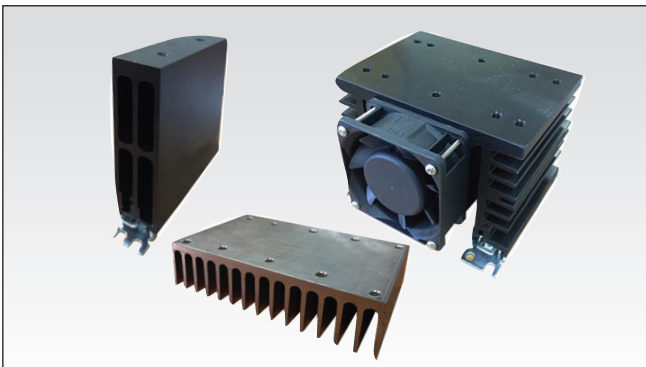

Heatsink Range Overview:

http://www.productselection.net/PDF/UK/ssr_accessories.pdf

Heatsink Selector Tool:

<http://www.productselection.net/heatsink/heatsinkselector.php?LANG=UK>

Ordering Key

RHS..

- Heatsinks and fans
- 5.40°C/W to 0.12°C/W thermal resistance
- DIN, panel or thru wall mounting
- Single or multiple SSR mounting

Short Circuit Protection

Protection Co-ordination, Type 1 vs. Type 2:

Type 1 protection implies that after a short circuit, the device under test will no longer be in a functioning state. In type 2 co-ordination the device under test will still be functional after the short circuit. In both cases, however, the short circuit has to be interrupted. The fuse between enclosure and supply shall not open. The door or cover of the enclosure shall not be blown open. There shall be no damage to conductors of terminals and the conductors shall not separate from terminals. There shall be no breakage or cracking of insulating bases to the extent that the integrity of the mounting of live parts is impaired. Discharge of parts or any risk of fire shall not occur.

The product variants listed in the table hereunder are suitable for use on a circuit capable of delivering not more than 65,000A rms Symmetrical Amperes, 600Volts maximum when protected by fuses. Tests at 65,000A were performed with Class J, fast acting; please refer to the table below for maximum allowed ampere rating of the fuse. Use fuses only.

Co-ordination Type 1 (UL508)

Part No.	Prospective short circuit current [kArms]	Max. fuse size [A]	Class	Voltage [VAC]
RM1E..25..	65	30	J / CC	600
RM1E..50..	65	30	J	600
		20	HSJ20 (Mersen*)	600
RM1E..75..	65	100	J	600
RM1E..100..	65	80	J	600
		60	HSJ60 (Mersen*)	600
RM1E..125..	65	125	J	600
		60	HSJ60 (Mersen*)	600

Co-ordination Type 2 (IEC/EN60947-4-3)

Part No.	Prospective short circuit current [kArms]	Max. fuse size [A]	Brand	Model	Size
RM1E.xx.25.. (xx = 23,40,48)	10	25	Mersen*	6.9gRB 10-25	10.3 x 38
RM1E.60..25..	10	20	Mersen*	6.9gRB 10-20	10.3 x 38
RM1E.xx.50.. (xx = 23,40)	10	50	Mersen*	6.9zz CP gRC 14x51/50	14 x 51
RM1E.xx.50.. (xx = 48,60)	10	50	Mersen*	6.9zz CP gRC 22x58/50	22 x 58
RM1E.xx.75.. (xx = 23,40,48,60)	10	63	Mersen*	6.9zz CP gRC 22x58/63	22 x 58
RM1E.xx.100.. (xx = 23,40,48)	10	100	Mersen*	6.9zz CP gRC 22x58/100	22 x 58
RM1E.xx.100.. (xx = 23,40,48)	10	80	Mersen*	6.9zz CP gRC 22x58/80	22 x 58
RM1E.xx.125.. (xx = 23 or 48)	10	125	Mersen*	6.921 CP URGD 27x60/125	27 x 60

zz = 00, without fuse trip indication

zz = 21, with fuse trip indication

* Formerly Ferraz Shawmut

Type 2 Protection with Miniature Circuit Breakers (M.C.B.s)

Solid State Relay type	ABB Model no. for Z - type M. C. B. (rated current)	ABB Model no. for B - type M. C. B. (rated current)	Wire cross sectional area [mm ²]	Minimum length of Cu wire conductor [m]*	
RM1E..25..	1-pole				
	S201-Z4 (4A)	S201-B2 (2A)	1.0	21.0	
	S201-Z6 UC (6A)	S201-B2 (2A)	1.0	21.0	
			1.5	31.5	
RM1E..50..	1-pole				
	S201-Z10 (10A)	S201-B4 (4A)	1.0	7.6	
			1.5	11.4	
			2.5	19.0	
	S201-Z16 (16A)	S201-B6 (6A)	1.0	5.2	
			1.5	7.8	
			2.5	13.0	
			4.0	20.8	
	S201-Z20 (20A)	S201-B10 (10A)	1.5	12.6	
			2.5	21.0	
	S201-Z25 (25A)	S201-B13 (13A)	2.5	25.0	
			4.0	40.0	
		2-poles			
S202-Z25 (25A)	S202-B13 (13A)	2.5	19.0		
		4.0	30.4		
RM1E..75.. RM1E..100..	1-pole				
	S201-Z20 (20A)	S201-B10 (10A)	1.5	4.2	
			2.5	7.0	
			4.0	11.2	
	S201-Z32 (32A)	S201-B16 (16A)	2.5	13.0	
			4.0	20.8	
			6.0	31.2	
		2-poles			
	S202-Z20 (20A)	S202-B10 (10A)	1.5	1.8	
			2.5	3.0	
			4.0	4.8	
	S202-Z32 (32A)	S202-B16 (16A)	2.5	5.0	
			4.0	8.0	
		6.0	12.0		
		10.0	20.0		
S202-Z50 (50A)	S202-B25 (25A)	4.0	14.8		
		6.0	22.2		
		10.0	37.0		
RM1E..125..	1-pole				
	S201-Z50 (50A)	S201-B25 (25A)	4.0	4.8	
			6.0	7.2	
			10.0	12.0	
			16.0	19.2	
	S201-Z63 (63A)	S201-B32 (32A)	6.0	7.2	
			10.0	12.0	
		16.0	19.2		

* Between MCB and Load (including return path which goes back to the mains).

Note: A prospective current of 6kA and a 230/400V power supply system is assumed for the above suggested specifications. For cables with different cross section than those mentioned above please consult Carlo Gavazzi's Technical Support Group.

Environmental Information

The declaration in this section is prepared in compliance with People's Republic of China Electronic Industry Standard SJ/T11364-2014: Marking for the Restricted Use of Hazardous Substances in Electronic and Electrical Products.

Part Name	Toxic or Harardous Substances and Elements					
	Lead (Pb)	Mercury (Hg)	Cadmium (Cd)	Hexavalent Chromium (Cr(VI))	Polybrominated biphenyls (PBB)	Polybrominated diphenyl ethers (PBDE)
Power Unit Assembly	x	0	0	0	0	0
<p>O: Indicates that said hazardous substance contained in homogeneous materials for this part are below the limit requirement of GB/T 26572.</p> <p>X: Indicates that said hazardous substance contained in one of the homogeneous materials used for this part is above the limit requirement of GB/T 26572.</p>						

环境特性

这份申明根据中华人民共和国电子工业标准 SJ/T11364-2014：标注在电子电气产品中限定使用的有害物质

零件名称	有毒或有害物质与元素					
	铅 (Pb)	汞 (Hg)	镉 (Cd)	六价铬 (Cr(VI))	多溴化联苯 (PBB)	多溴联苯醚 (PBDE)
功率单元	x	0	0	0	0	0
<p>0: 此零件所有材料中含有的该有害物低于GB/T 26572的限定。</p> <p>X: 此零件某种材料中含有的该有害物高于GB/T 26572的限定。</p>						



FASTON Terminals



- Faston tabs
- Tab dimensions according to DIN 46342 part 1
- Pure tin-plated brass

Ordering Key

Screw mounted Faston terminals

RM1E48V25 F 4

RAM Solid State Relay
Faston terminals
Tab orientation

Input Tab width: 4.8mm
Output Tab width: 6.3mm

Faston terminals in packs of 20

RM48 F4

RS, RM Solid State Relay
Tab orientation

- * 0: Flat (0°)
- 4: Angled (45°)

- ** 48: 4.8mm faston for input
- 63: 6.3mm faston for output

Fork Terminals

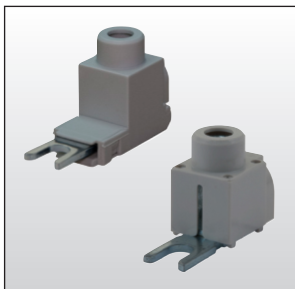

- Terminal adaptors for 35mm² cable
- Type RM635FK
- Pack size: 10 pieces

Ordering Key

RM635FK P

RM terminal adaptor
Touch protected (optional)

Other Accessories

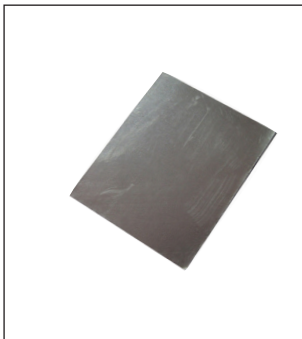

- Graphite thermal pad with adhesive on one side
- Type KK071CUT
- Dimensions: 35 x 43 x 0.25mm
- Packing quantity: 50pcs.



- Touch safety cover
- Type RMIP20
- IP20 protection degree
- Pack size: 20 pieces

All accessories can be ordered pre-assembled with Solid State Relays.
Other accessories include DIN rail adaptors, fuses, varistors and spacers.

For further information refer to Accessories datasheets at:
www.productselection.net/PDF/UK/SSR_Accessories.pdf