

## Description

The IDT XL devices (XO and VCXO options) are ultra-precision crystal oscillators with 750 to 890fs typical phase jitter over 12kHz to 20MHz bandwidth. Available in a wide frequency range from 0.750MHz to 1350MHz, the XL series crystal oscillators utilize a family of proprietary ASICs, with a key focus on noise reduction technologies.

The 3rd order Delta Sigma Modulator reduces noise to the levels that are comparable to traditional Bulk Quartz and SAW oscillators. With short lead-time, low cost, low noise, wide frequency range, excellent ambient performance, the XL devices are an excellent choice over the conventional technologies. The XL (XO option) devices have stabilities as tight as  $\pm 20$ ppm and the XL (VCXO option) devices have  $\pm 50$ ppm APR. Either option provides extremely quick delivery for both standard and custom frequencies.

## Features

- Output types: LVDS, LVPECL, LVCMOS
- Phase jitter (12kHz to 20MHz): 750fs to 890fs typical
- Supply voltage: 2.5V or 3.3V
- Package options:
  - 3.2 × 2.5 × 1.0 mm (not available for VCXO)
  - 5.0 × 3.2 × 1.2 mm
  - 7.0 × 5.0 × 1.3 mm
- Operating temperature: -20°C to +70°C
  - Frequency stability options:  $\pm 20$ ,  $\pm 25$ ,  $\pm 50$ , or  $\pm 100$  ppm (XO only)
  - $\pm 50$ ppm APR (VCXO only)
- Operating temperature: -40°C to +85°C
  - Frequency stability options:  $\pm 25$ ,  $\pm 50$ , or  $\pm 100$  ppm (XO only)
  - $\pm 50$ ppm APR (VCXO only)
- Operating temperature: -40°C to +105°C (XO only)
  - Frequency stability options:  $\pm 50$  or  $\pm 100$  ppm
- kV of 85ppm/volt typical from 0.5VDC to VDD (VCXO only)
  - Better than  $\pm 10\%$  linearity for Vc range

## Pin Assignments (XO option)

NOTE: To minimize power supply line noise, a 0.01 $\mu$ F bypass capacitor should be placed between V<sub>DD</sub> (Pin 6) and GND (Pin 3) on 6-pin devices, or V<sub>DD</sub> (Pin 4) and GND (Pin 2) on 4-pin devices.

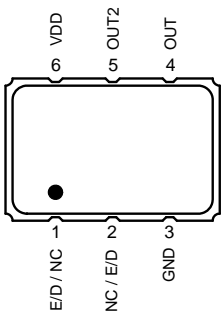

Table 1. XO 6-pin Package

Number	Name	Description
1	E/D NC	Enable/Disable <sup>[a][b]</sup> No connect
2	NC E/D	No connect Enable/Disable <sup>[a][b]</sup>
3	GND	Connect to ground
4	OUT	Output
5	OUT2	Complementary output
6	V <sub>DD</sub>	Supply voltage

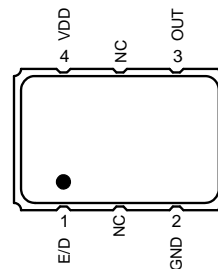

Table 2. XO 4-pin Package

Number	Name	Description
1	E/D	Enable/Disable <sup>[a][b]</sup>
2	GND	Connect to ground
3	OUT	Output
4	V <sub>DD</sub>	Supply voltage

[a] Pulled high internally.

[b] Low = output disabled.

See [Ordering Information \(XO\)](#) for more details.

## Pin Assignments (VCXO option)

NOTE: To minimize power supply line noise, a 0.01 $\mu$ F bypass capacitor should be placed between V<sub>DD</sub> (Pin 6) and GND (Pin 3).

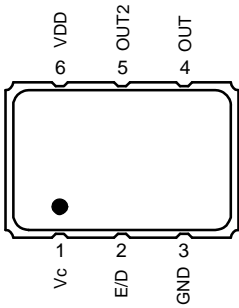

Table 3. VCXO 6-pin Package

Number	Name	Description
1	Vc	Voltage control
2	E/D	Enable/Disable <sup>[a][b]</sup>
3	GND	Connect to ground
4	OUT	Output
5	OUT2	Complementary output (NC LVCMOS)
6	V <sub>DD</sub>	Supply voltage

[a] Pulled high internally.

[b] Low = output disabled.

See [Ordering Information \(VCXO\)](#) for more details.

# Contents

Description .....	1
Features .....	1
Pin Assignments (XO option) .....	1
Pin Assignments (VCXO option) .....	2
Absolute Maximum Ratings .....	4
ESD Compliance .....	4
Mechanical Testing .....	4
Solder Reflow Profile .....	4
DC Electrical Characteristics .....	5
AC Electrical Characteristics .....	8
Output Waveforms – LVDS .....	11
Output Waveforms – LVPECL .....	11
Output Waveforms – LVCMOS .....	12
Package Outline Drawings .....	13
Ordering Information (XO) .....	13
Ordering Information (VCXO) .....	14
Revision History .....	15

## Absolute Maximum Ratings

Stresses above the ratings listed below can cause permanent damage to the device. These ratings, which are standard values for IDT commercially rated parts, are stress ratings only. Functional operation of the device at these or any other conditions above those indicated in the operational sections of the specifications is not implied. Exposure to absolute maximum rating conditions for extended periods can affect product reliability. Electrical parameters are guaranteed only over the recommended operating temperature range.

Table 4. Absolute Maximum Ratings

Item	Rating					
$V_{DD}$	-0.5 to +5.0V					
E/D	-0.5V to $V_{DD} + 0.5V$					
OUT	-0.5V to $V_{DD} + 0.5V$					
Storage Temperature	-55°C to 125°C					
Maximum Junction Temperature	125°C					
Core Current	65mA maximum					
Theta $J_A$	JU6	75.9 °C/W	JS6	89.6 °C/W	JX6	94.7 °C/W
Theta $J_B$	7.0 × 5.0 × 1.3 mm	48.6°C/W	5.0 × 3.2 × 1.2 mm	54.3 °C/W	3.2 × 2.5 × 1.0 mm	66.8 °C/W

## ESD Compliance

Table 5. ESD Compliance

Human Body Model (HBM)	1000V
Machine Model (MM)	150V

## Mechanical Testing

Table 6. Mechanical Testing

Parameter	Test Method
Mechanical Shock	Drop from 75cm to hardwood surface–3 times.
Mechanical Vibration	10–55Hz, 1.5mm amplitude, 1 minute sweep; 2 hours each in 3 directions (X, Y, Z).
High Temperature Burn-in	Under power at 125°C for 2000 hours.
Hermetic Seal	He pressure: 4 ±1kgf/cm <sup>2</sup> 2 hour soak.

## Solder Reflow Profile

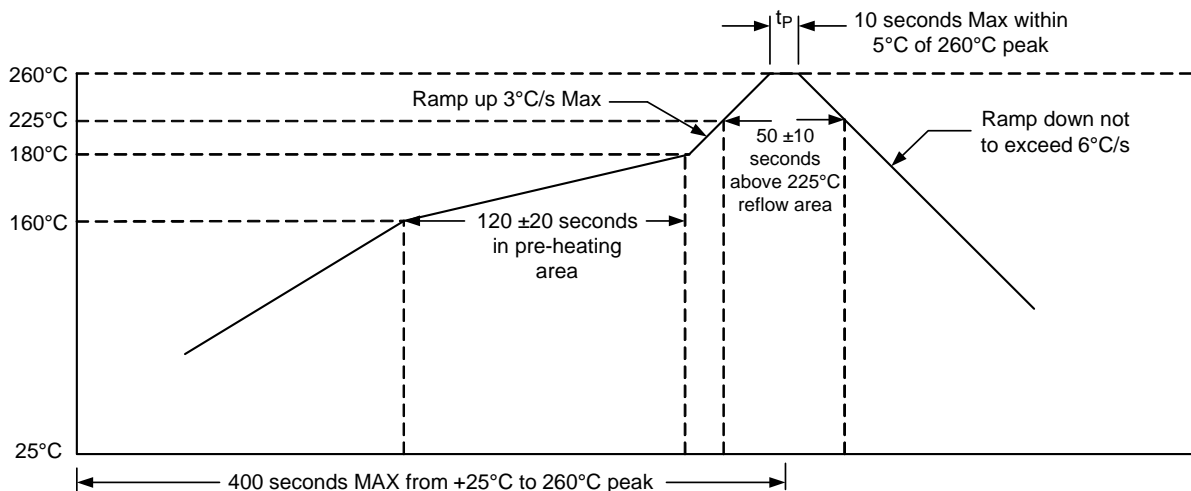

## DC Electrical Characteristics

Table 7. 3.3V IDD DC Electrical Characteristics

 $V_{DD} = 3.3V \pm 5\%$ ,  $T_A = -20^{\circ}C$  to  $+70^{\circ}C$ ;  $-40^{\circ}C$  to  $+85^{\circ}C$ ,  $-40^{\circ}C$  to  $+105^{\circ}C$ .

Symbol	Parameter	Output Type	Conditions	Minimum	Typical	Maximum	Units
$I_{DD}$	Power Supply Current	LVDS	—	—	—	100	mA
		LVPECL	—	—	—	120	
		LVCMOS	0.75MHz to 20MHz.	—	—	32	
			20+MHz to 50MHz.	—	—	35	
			50+MHz to 130MHz.	—	—	47	
			130+MHz to 200MHz.	—	—	55	
200+MHz to 250MHz.	—	—	60				

Table 8. 2.5V IDD DC Electrical Characteristics

 $V_{DD} = 2.5V \pm 5\%$ ,  $T_A = -20^{\circ}C$  to  $+70^{\circ}C$ ;  $-40^{\circ}C$  to  $+85^{\circ}C$ ,  $-40^{\circ}C$  to  $+105^{\circ}C$ .

Symbol	Parameter	Output Type	Conditions	Minimum	Typical	Maximum	Units
$I_{DD}$	Power Supply Current	LVDS	0.75MHz to 20MHz.	—	—	26	mA
			20+MHz to 220MHz.	—	—	34	
			220+MHz to 630MHz.	—	—	44	
			630+MHz to 1000MHz.	—	—	65	
		LVPECL	0.75MHz to 20MHz.	—	—	33	
			20+MHz to 220MHz.	—	—	41	
			220+MHz to 630MHz.	—	—	63	
			630+MHz to 1000MHz.	—	—	72	
		LVCMOS	0.75MHz to 20MHz.	—	—	22	
			20+MHz to 50MHz.	—	—	25	
			50+MHz to 100MHz.	—	—	29	
			100+MHz to 130MHz.	—	—	32	
			130+MHz to 160MHz.	—	—	35	
			160+MHz to 180MHz.	—	—	37	

Table 9. LVDS DC Electrical Characteristics

 $V_{DD} = 3.3V, 2.5V \pm 5\%$ ,  $T_A = -20^\circ C$  to  $+70^\circ C$ ;  $-40^\circ C$  to  $+85^\circ C$ ,  $-40^\circ C$  to  $+105^\circ C$ . Below are guaranteed for listed standard frequencies.

Symbol	Parameter	Conditions	Minimum	Typical	Maximum	Units
$V_{OD}$	Differential Output Voltage	$V_{DD} = 3.3V \pm 5\%$ .	—	—	0.6	V
		$V_{DD} = 2.5V \pm 5\%$ .	—	—	0.4	
$V_{OS}$	Output Offset Voltage	$V_{DD} = 3.3V \pm 5\%$ .	—	—	1.3	
		$V_{DD} = 2.5V \pm 5\%$ .	—	—	1.25	
$V_{IH}$	Enable/Disable Input High Voltage (Output enabled)	—	70% $V_{DD}$	—	—	
$V_{IL}$	Enable/Disable Input Low Voltage (Output disabled)	—	—	—	30% $V_{DD}$	

Table 10. LVPECL DC Electrical Characteristics

 $V_{DD} = 3.3V, 2.5V \pm 5\%$ ,  $T_A = -20^\circ C$  to  $+70^\circ C$ ;  $-40^\circ C$  to  $+85^\circ C$ ,  $-40^\circ C$  to  $+105^\circ C$ . Below are guaranteed for listed standard frequencies.

Symbol	Parameter	Conditions	Minimum	Typical	Maximum	Units
$V_{OD}$	Differential Output Voltage	$V_{DD} = 3.3V \pm 5\%$ .	2.055	—	2.405	V
		$V_{DD} = 2.5V \pm 5\%$ .	—	1.4	—	
$V_{OS}$	Output Offset Voltage	$V_{DD} = 3.3V \pm 5\%$ .	1.305	—	1.65	
		$V_{DD} = 2.5V \pm 5\%$ .	—	0.68	—	
$V_{IH}$	Enable/Disable Input High Voltage (Output enabled)	—	70% $V_{DD}$	—	—	
$V_{IL}$	Enable/Disable Input Low Voltage (Output disabled)	—	—	—	30% $V_{DD}$	

Table 11. LVC MOS DC Electrical Characteristics

 $V_{DD} = 3.3V, 2.5V \pm 5\%$ ,  $T_A = -20^\circ C$  to  $+70^\circ C$ ;  $-40^\circ C$  to  $+85^\circ C$ ,  $-40^\circ C$  to  $+105^\circ C$ . Below are guaranteed for listed standard frequencies.

Symbol	Parameter	Conditions		Minimum	Typical	Maximum	Units
$V_{OH}$	Output High Voltage	$V_{DD} = 3.3V \pm 5\%$ .	0.75MHz to 150MHz.	90% $V_{DD}$	—	—	V
			150+MHz to 250MHz.	80% $V_{DD}$	—	—	
		$V_{DD} = 2.5V \pm 5\%$ .	0.75MHz to 160MHz.	90% $V_{DD}$	—	—	
			160+MHz to 180MHz.	80% $V_{DD}$	—	—	
$V_{OL}$	Output Low Voltage	$V_{DD} = 3.3V \pm 5\%$ .	0.75MHz to 150MHz.	—	—	10% $V_{DD}$	
			150+MHz to 250MHz.	—	—	20% $V_{DD}$	
		$V_{DD} = 2.5V \pm 5\%$ .	0.75MHz to 160MHz.	—	—	10% $V_{DD}$	
			160+MHz to 180MHz.	—	—	20% $V_{DD}$	
$V_{IH}$	Enable/Disable Input High Voltage (Output enabled)	—	—	70% $V_{DD}$	—	—	
$V_{IL}$	Enable/Disable Input Low Voltage (Output disabled)	—	—	—	—	30% $V_{DD}$	

## AC Electrical Characteristics

Table 12. 3.3V AC Electrical Characteristics

 $V_{DD} = 3.3V \pm 5\%$ ,  $T_A = -20^\circ C$  to  $+70^\circ C$ ;  $-40^\circ C$  to  $+85^\circ C$ ,  $-40^\circ C$  to  $+105^\circ C$ .

Symbol	Parameter	Test Condition		Minimum	Typical	Maximum	Units
F	Output Frequency Range	LVDS.		0.75	—	1350	MHz
		LVPECL.		0.75	—	1350	
		LVCMOS.		0.75	—	250	
	Frequency Stability	Temperature = $-20^\circ C$ to $+70^\circ C$ .		$\pm 20$	—	$\pm 100$	ppm
		Temperature = $-40^\circ C$ to $+85^\circ C$ .		$\pm 25$	—	$\pm 100$	ppm
		Temperature = $-40^\circ C$ to $+105^\circ C$ .		$\pm 50$	—	$\pm 100$	ppm
	Aging (1st year)	$T_A = 25^\circ C$ .		—	—	$\pm 3$	ppm
	Aging (10 years)	$T_A = 25^\circ C$ .		—	—	$\pm 10$	ppm
	Output Load	LVDS.	Differential.	—	100	—	$\Omega$
		LVPECL.	$V_{DD} - 2.0V$ .	—	50	—	
		LVCMOS.	To GND.	—	15	—	pF
$T_{ST}$	Start-up Time	Output valid time after $V_{DD}$ meets minimum specified level.		—	—	10	ms
$t_R$	Output Rise Time	LVDS.	20% to 80% $V_{pp}$ .	—	—	400	ps
		LVPECL.		—	—	400	
		LVCMOS.	10% to 90% $V_{DD}$ .	—	—	3	ns
$t_F$	Output Fall Time	LVDS.	80% to 20% $V_{pp}$ .	—	—	400	ps
		LVPECL.		—	—	400	
		LVCMOS.	90% to 10% $V_{DD}$ .	—	—	3	ns
$O_{DC}$	Output Clock Duty Cycle	LVDS.		45	—	55	%
		LVPECL.		45	—	55	
		LVCMOS.	$F_{OUT} \leq 62.5MHz$ .	45	—	55	
			$F_{OUT} \leq 62.5MHz$ .	40	—	60	
$T_{OE}$	Output Enable/ Disable Time	—		—	—	100	ns
$J_{PER}$	Period Jitter, RMS	LVDS.		—	3	—	ps
		LVPECL.		—	5.8	—	
		LVCMOS.	$F_{OUT} = 125MHz$ .	—	5	—	
$R_J$	Random Jitter	LVDS.		—	1.3	—	ps
		LVPECL.		—	1.29	—	
		LVCMOS.	$F_{OUT} = 125MHz$ .	—	0.6	—	
$D_J$	Deterministic Jitter	LVDS.		—	5.8	—	ps
		LVPECL.		—	9.3	—	
		LVCMOS.	$F_{OUT} = 125MHz$ .	—	10	—	



Table 12. 3.3V AC Electrical Characteristics (Cont.)

 $V_{DD} = 3.3V \pm 5\%$ ,  $T_A = -20^\circ C$  to  $+70^\circ C$ ;  $-40^\circ C$  to  $+85^\circ C$ ,  $-40^\circ C$  to  $+105^\circ C$ .

Symbol	Parameter	Test Condition	Minimum	Typical	Maximum	Units
$T_J$	Total Jitter	LVDS.	—	23.6	—	ps
		LVPECL.	—	27.7	—	
		LVC MOS.	$F_{OUT} = 125MHz.$	—	19	
$f_{JITTER}$	Phase Jitter (12kHz–20MHz)	LVDS.	—	890	—	fs
		LVPECL.	—	860	—	
		LVC MOS.	$F_{OUT} = 125MHz.$	—	750	

Table 13. 2.5V AC Electrical Characteristics

 $V_{DD} = 2.5V \pm 5\%$ ,  $T_A = -20^\circ C$  to  $+70^\circ C$ ;  $-40^\circ C$  to  $+85^\circ C$ ,  $-40^\circ C$  to  $+105^\circ C$ .

Symbol	Parameter	Test Condition	Minimum	Typical	Maximum	Units	
F	Output Frequency Range	LVDS.	0.75	—	1000	MHz	
		LVPECL.	0.75	—	1000		
		LVC MOS.	0.75	—	180		
	Frequency Stability	Temperature = $-20^\circ C$ to $+70^\circ C$ .	$\pm 20$	—	$\pm 100$	ppm	
		Temperature = $-40^\circ C$ to $+85^\circ C$ .	$\pm 25$	—	$\pm 100$	ppm	
		Temperature = $-40^\circ C$ to $+105^\circ C$ .	$\pm 50$	—	$\pm 100$	ppm	
	Aging (1st year)	$T_A = 25^\circ C$ .	—	—	$\pm 3$	ppm	
	Aging (10 years)	$T_A = 25^\circ C$ .	—	—	$\pm 10$	ppm	
	Output Load	LVDS.	Differential.	—	100	$\Omega$	
		LVPECL.	$V_{DD} - 2.0V$ .	—	50		
		LVC MOS.	To GND.	—	15	$\mu F$	
$T_{ST}$	Start-up Time	Output valid time after $V_{DD}$ meets minimum specified level.	—	—	10	ms	
$t_R$	Output Rise Time	LVDS.	20% to 80% $V_{pp}$ .	—	—	400	ps
		LVPECL.		—	—	400	
		LVC MOS.	10% to 90% $V_{DD}$ .	—	—	3.5	ns
$t_F$	Output Fall Time	LVDS.	80% to 20% $V_{pp}$ .	—	—	400	ps
		LVPECL.		—	—	400	
		LVC MOS.	90% to 10% $V_{DD}$ .	—	—	3	ns
$O_{DC}$	Output Clock Duty Cycle	LVDS.	45	—	55	%	
		LVPECL.	45	—	55		
		LVC MOS.	45	—	55		
$T_{OE}$	Output Enable/ Disable Time	—	—	—	100	ns	

Table 13. 2.5V AC Electrical Characteristics (Cont.)

 $V_{DD} = 2.5V \pm 5\%$ ,  $T_A = -20^{\circ}C$  to  $+70^{\circ}C$ ;  $-40^{\circ}C$  to  $+85^{\circ}C$ ,  $-40^{\circ}C$  to  $+105^{\circ}C$ .

Symbol	Parameter	Test Condition	Minimum	Typical	Maximum	Units
$J_{PER}$	Period Jitter, RMS	LVDS.	—	4	—	ps
		LVPECL.	—	5.12	—	
		LVC MOS.	$F_{OUT} = 125MHz.$	—	3.3	
$R_J$	Random Jitter	LVDS.	—	1.4	—	ps
		LVPECL.	—	1.36	—	
		LVC MOS.	$F_{OUT} = 125MHz.$	—	1.3	
$D_J$	Deterministic Jitter	LVDS.	—	9.2	—	ps
		LVPECL.	—	10	—	
		LVC MOS.	$F_{OUT} = 125MHz.$	—	6.7	
$T_J$	Total Jitter	LVDS.	—	29.2	—	ps
		LVPECL.	—	29.3	—	
		LVC MOS.	$F_{OUT} = 125MHz.$	—	25.6	
$f_{JITTER}$	Phase Jitter (12kHz–20MHz)	LVDS.	—	1040	—	fs
		LVPECL.	—	1200	—	
		LVC MOS.	$F_{OUT} = 125MHz.$	—	850	

Notes for all AC Electrical Characteristics tables:

<sup>1</sup> All jitter values provided at 156.25MHz, unless noted otherwise.

## Output Waveforms – LVDS

### Output Levels/Rise Time/Fall Time Measurements

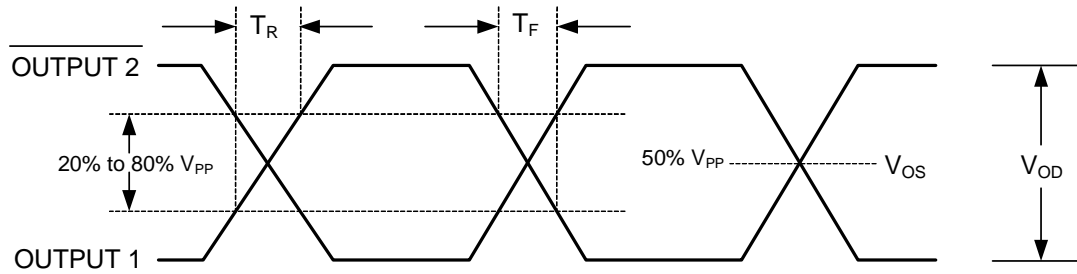

### Oscillator Symmetry

Ideally, Symmetry should be 50/50 for  $\frac{1}{2}$  period – Other expressions are 45/55 or 55/45

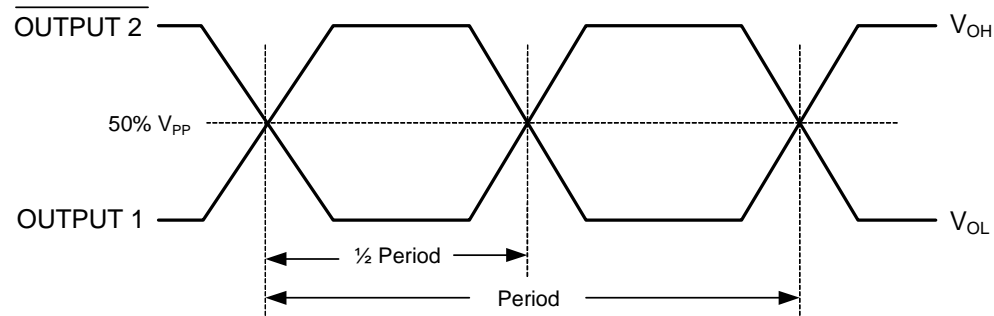

## Output Waveforms – LVPECL

### Rise Time/Fall Time Measurements

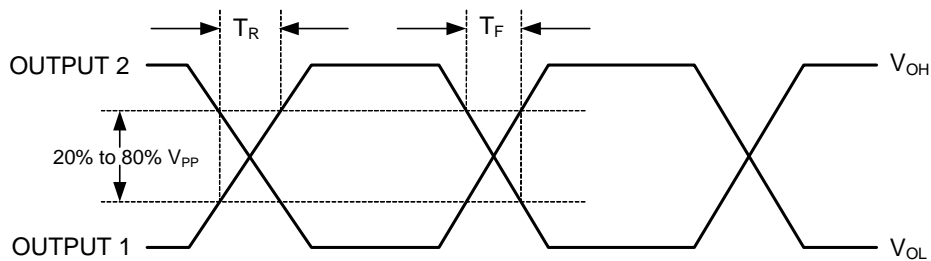

### Oscillator Symmetry

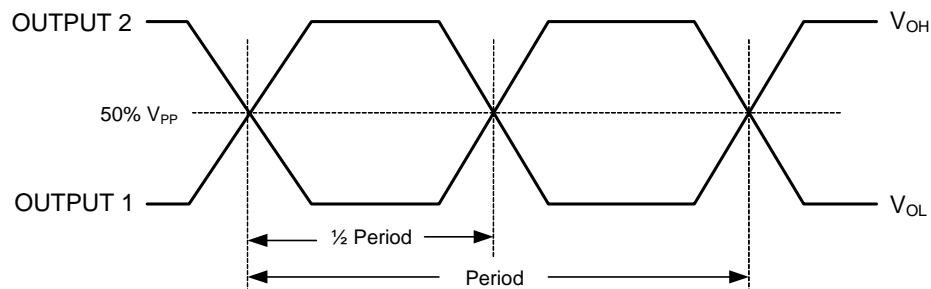

# Output Waveforms – LVCMOS

## Rise Time / Fall Time Measurements

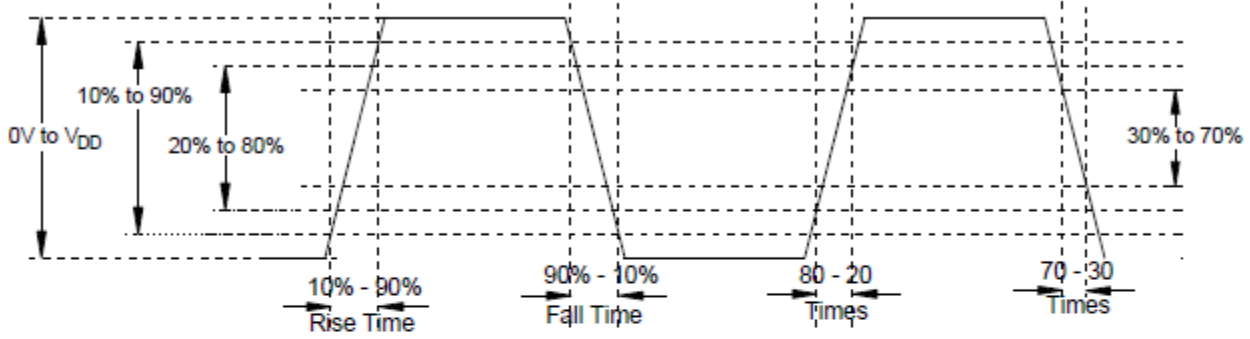

## Oscillator Symmetry

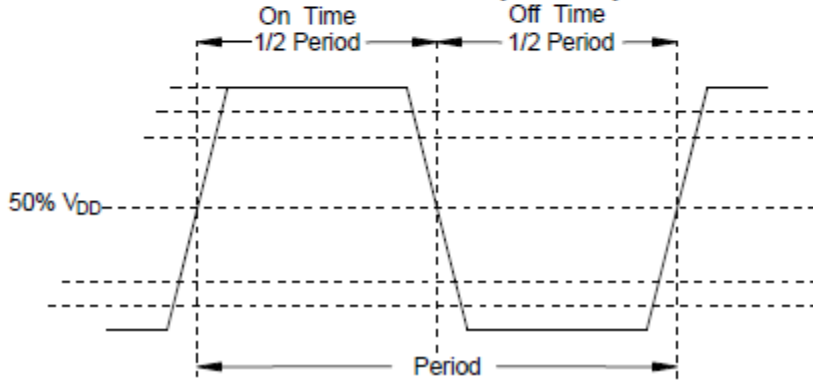

## Package Outline Drawings

The package outline drawings are appended at the end of this document and are accessible from the links below. The package information is the most current data available.

[www.idt.com/document/psc/js6-package-outline-50-x-32-mm-body-11-mm-thick](http://www.idt.com/document/psc/js6-package-outline-50-x-32-mm-body-11-mm-thick)

[www.idt.com/document/psc/jx6-package-outline-32-x-25-mm-body-09-mm-thick](http://www.idt.com/document/psc/jx6-package-outline-32-x-25-mm-body-09-mm-thick)

[www.idt.com/document/psc/ju6-package-outline-70-x-50-mm-body-13-mm-thick](http://www.idt.com/document/psc/ju6-package-outline-70-x-50-mm-body-13-mm-thick)

[www.idt.com/document/psc/js4-package-outline-50-x-32-mm-body-11-mm-thick](http://www.idt.com/document/psc/js4-package-outline-50-x-32-mm-body-11-mm-thick)

[www.idt.com/document/psc/ju4-package-outline-70-x-50-mm-body-13-mm-thick](http://www.idt.com/document/psc/ju4-package-outline-70-x-50-mm-body-13-mm-thick)

[www.idt.com/document/psc/jx4-package-outline-32-x-25-mm-body-09-mm-thick](http://www.idt.com/document/psc/jx4-package-outline-32-x-25-mm-body-09-mm-thick)

## Ordering Information (XO)

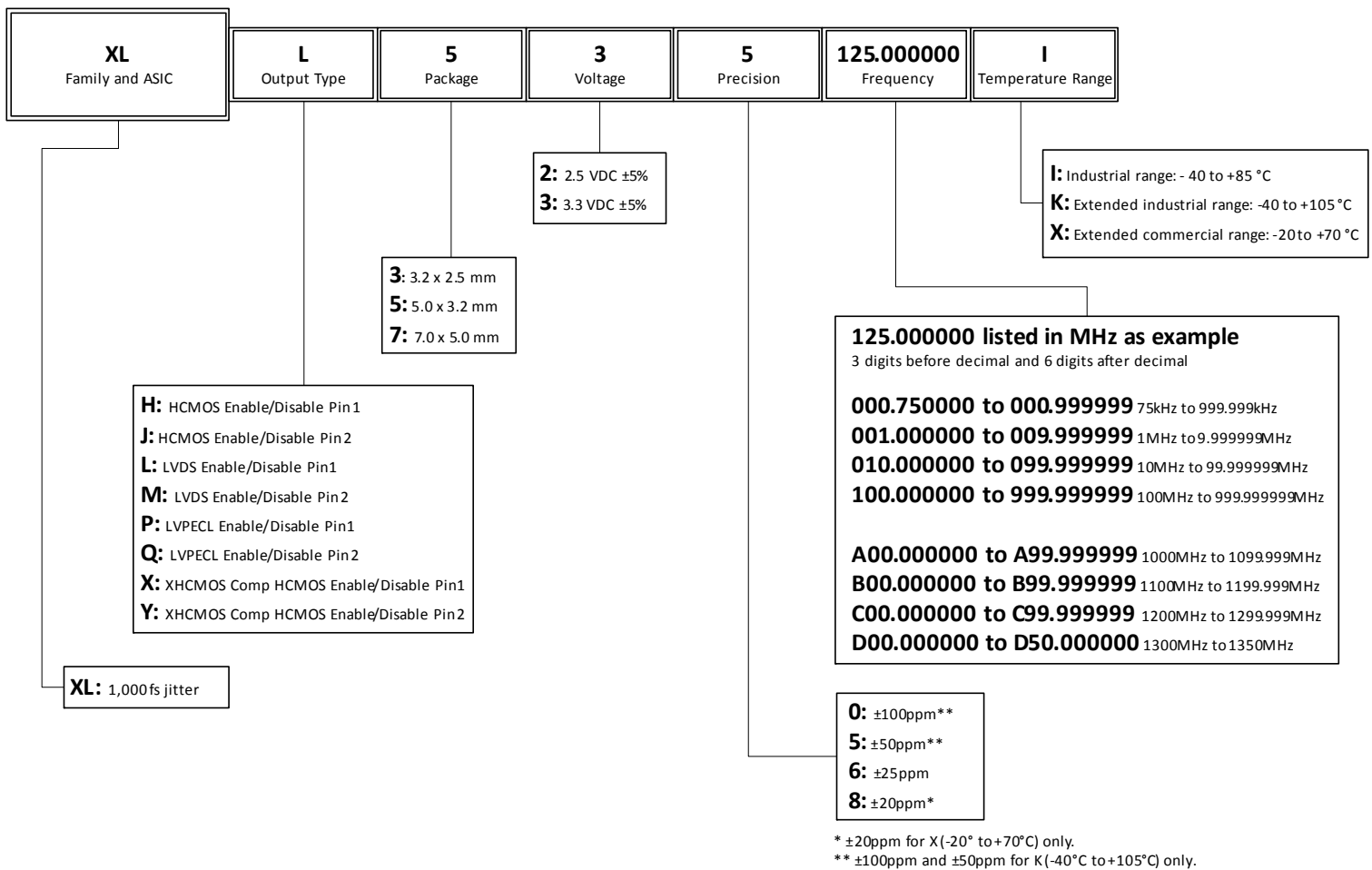

# Ordering Information (VCXO)

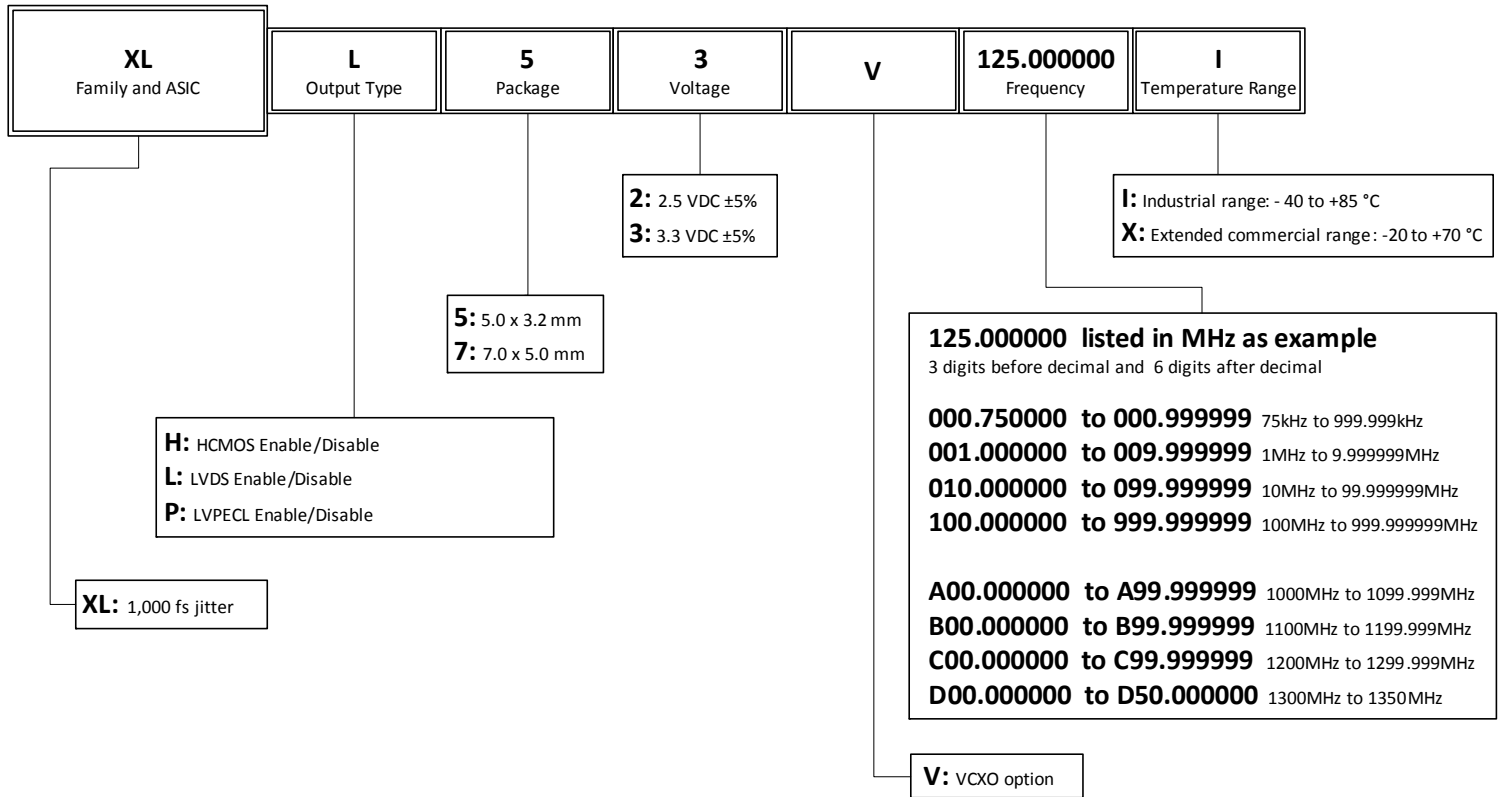

## Revision History

Revision Date	Description of Change
September 7, 2018	Updated frequency stability options value from $\pm 20$ ppm to $\pm 25$ ppm for $-40^{\circ}\text{C}$ to $+85^{\circ}\text{C}$ XO only.
June 25, 2018	<ul style="list-style-type: none"> <li>▪ Updated Package Outline Drawings section.</li> </ul>
May 4, 2018	<ul style="list-style-type: none"> <li>▪ Added XO and VCXO options.</li> <li>▪ Updated description and Features sections.</li> <li>▪ Updated Package Outline Drawings section.</li> <li>▪ Added VCXO Ordering Information decoder diagram.</li> </ul>
January 12, 2018	Initial release.



Corporate Headquarters  
 6024 Silver Creek Valley Road  
 San Jose, CA 95138 USA  
[www.IDT.com](http://www.IDT.com)

Sales  
 1-800-345-7015 or 408-284-8200  
 Fax: 408-284-2775  
[www.IDT.com/go/sales](http://www.IDT.com/go/sales)

Tech Support  
[www.IDT.com/go/support](http://www.IDT.com/go/support)

DISCLAIMER Integrated Device Technology, Inc. (IDT) and its affiliated companies (herein referred to as "IDT") reserve the right to modify the products and/or specifications described herein at any time, without notice, at IDT's sole discretion. Performance specifications and operating parameters of the described products are determined in an independent state and are not guaranteed to perform the same way when installed in customer products. The information contained herein is provided without representation or warranty of any kind, whether express or implied, including, but not limited to, the suitability of IDT's products for any particular purpose, an implied warranty of merchantability, or non-infringement of the intellectual property rights of others. This document is presented only as a guide and does not convey any license under intellectual property rights of IDT or any third parties.

IDT's products are not intended for use in applications involving extreme environmental conditions or in life support systems or similar devices where the failure or malfunction of an IDT product can be reasonably expected to significantly affect the health or safety of users. Anyone using an IDT product in such a manner does so at their own risk, absent an express, written agreement by IDT.

Integrated Device Technology, IDT and the IDT logo are trademarks or registered trademarks of IDT and its subsidiaries in the United States and other countries. Other trademarks used herein are the property of IDT or their respective third party owners. For datasheet type definitions and a glossary of common terms, visit [www.idt.com/go/glossary](http://www.idt.com/go/glossary). Integrated Device Technology, Inc. All rights reserved.

REVISIONS			
REV	DESCRIPTION	DATE	APPROVED
00	INITIAL RELEASE	04/2/12	DP
01	ADDED LID IN TOP VIEW	07/12/12	KS
02	UPDATED LID TOLERANCES	12/03/12	KS
03	UPDATE PACKAGE DRAWING	8/8/14	JHUA

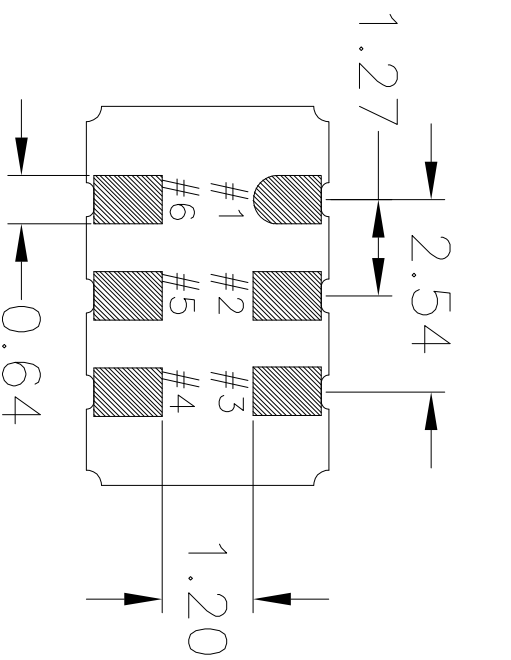

BOTTOM VIEW

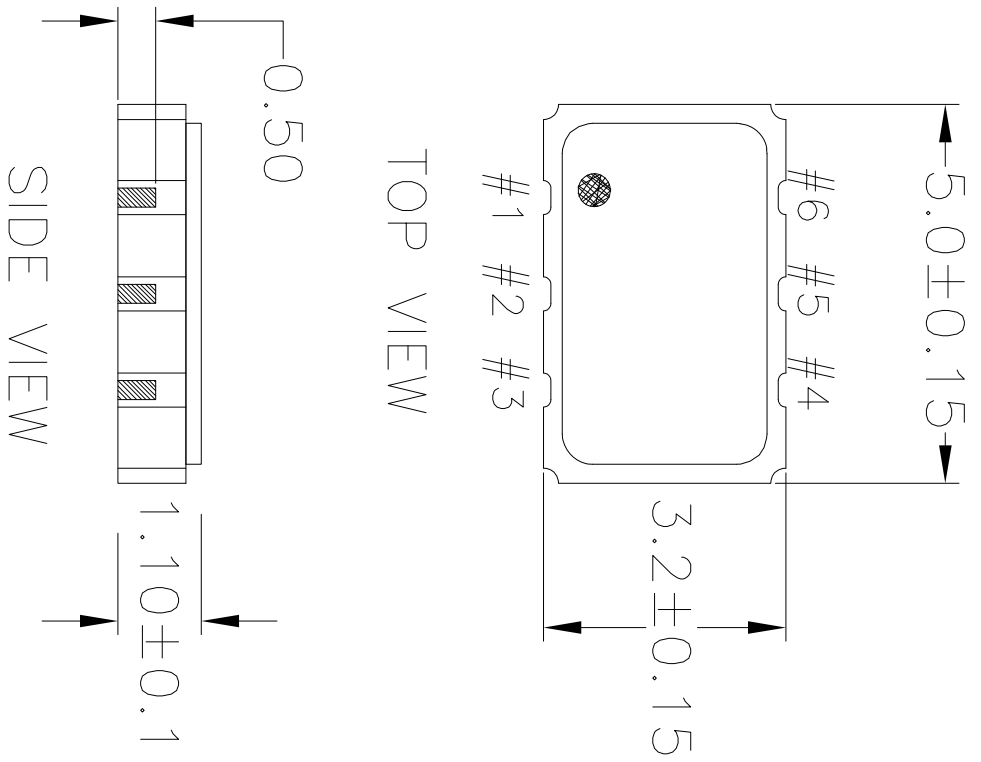

TOP VIEW

SIDE VIEW

NOTES:  
1. ALL DIMENSIONS IN MM.

TOLERANCES UNLESS SPECIFIED		6024 Silver Creek Valley Rd	
DECIMAL	ANGULAR	Son Jose, CA 95138	
XXX±	±	PHONE: (408) 727-6116	
XXXX±		FAX: (408) 492-8874	
XXXX±			
APPROVALS	DATE	TITLE	SIZE
DRAWN <i>QAC</i>	04/2/12	JS6 PACKAGE OUTLINE	DRAWING No.
CHECKED		5.0 x 3.2 mm BODY	PSC-4411
		1.1 mm Thick	REV
			03
DO NOT SCALE DRAWING			SHEET 1 OF 2





REVISIONS			
REV	DESCRIPTION	DATE	APPROVED
00	INITIAL RELEASE	04/2/12	DP
01	ADDED LID IN TOP VIEW	07/12/12	KS
02	UPDATED LID TOLERANCES	12/03/12	KS
03	UPDATE PACKAGE DRAWING	8/8/14	JHUA

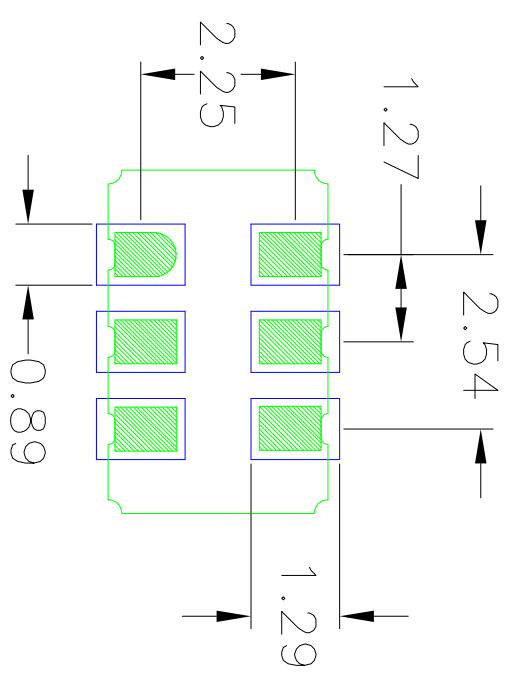

RECOMMENDED LAND PATTERN

- NOTES:
1. ALL DIMENSION ARE IN mm. ANGLES IN DEGREES.
  2. TOP DOWN VIEW. AS VIEWED ON PCB.
  3. COMPONENT OUTLINE SHOW FOR REFERENCE IN GREEN.
  4. LAND PATTERN IN BLUE. NSMD PATTERN ASSUMED.
  5. LAND PATTERN RECOMMENDATION PER IPC-7351B GENERIC REQUIREMENT FOR SURFACE MOUNT DESIGN AND LAND PATTERN.

TOLERANCES UNLESS SPECIFIED		6024 Silver Creek Valley Rd	
DECIMAL	ANGULAR	San Jose, CA 95138	
XXX±	±	PHONE: (408) 727-6176	
XXXX±		FAX: (408) 492-8674	
APPROVALS		www.IDT.com	
DRAWN	DATE	TITLE	
04/2/12		J56 PACKAGE OUTLINE	
CHECKED		5.0 x 3.2 mm BODY	
		1.1 mm Thick	
SIZE	DRAWING No.	REV	
C	PSC-4411	03	
DO NOT SCALE DRAWING			SHEET 2 OF 2

REVISIONS			
REV	DESCRIPTION	DATE CREATED	AUTHOR
00	INITIAL RELEASE	8/11/14	J.HUA
01	ADD PITCH	11/17/16	J.HUA
REFER TO DCP FOR OFFICIAL RELEASE DATE			

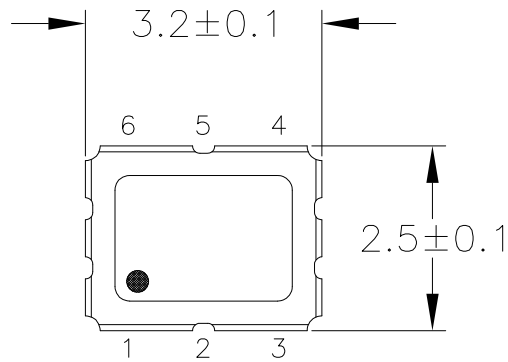

TOP VIEW

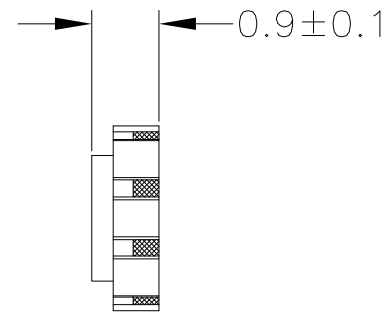

END VIEW

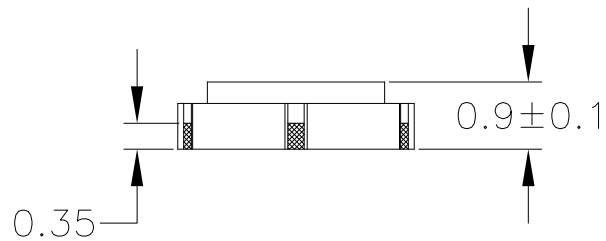

SIDE VIEW

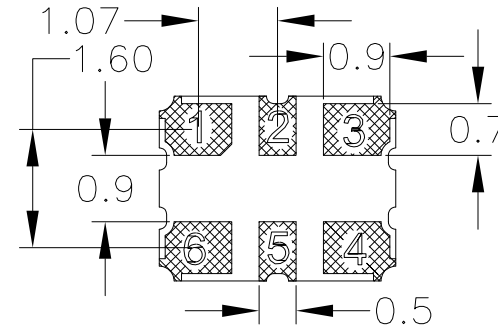

BOTTOM VIEW

NOTES:

1. ALL DIMENSIONS IN MM.

TOLERANCES UNLESS SPECIFIED		 6024 Silver Creek Valley Rd San Jose, CA 95138 PHONE: (408) 727-6116 FAX: (408) 492-8674 <a href="http://www.IDT.com">www.IDT.com</a>
DECIMAL	ANGULAR	
XX±	±	
XXX±		
XXXX±		
TITLE		JX6 PACKAGE OUTLINE
		3.2 x 2.5 mm BODY
		0.9 mm Thick
SIZE	DRAWING No.	REV
C	PSC-4412	01
DO NOT SCALE DRAWING		SHEET 1 OF 2

REVISIONS			
REV	DESCRIPTION	DATE CREATED	AUTHOR
00	INITIAL RELEASE	8/11/14	J.HUA
01	ADD PITCH	11/17/16	J.HUA
REFER TO DCP FOR OFFICIAL RELEASE DATE			

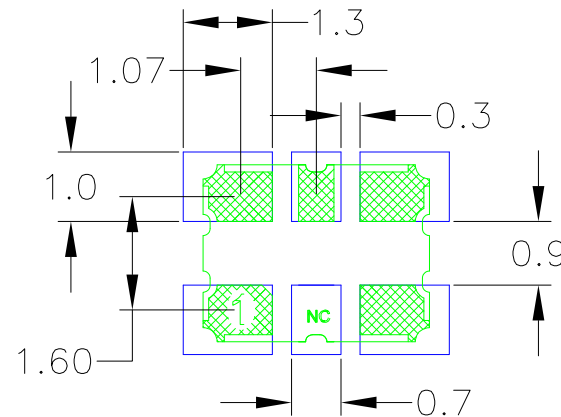

RECOMMENDED LAND PATTERN DIMENSION

NOTES:

1. ALL DIMENSIONS ARE IN MM. ANGLES IN DEGREES.
2. TOP DOWN VIEW. AS VIEWED ON PCB.
3. COMPONENT OUTLINE SHOWS FOR REFERENCE IN GREEN.
4. LAND PATTERN IN BLUE. NSMD PATTERN ASSUMED.
5. LAND PATTERN RECOMMENDATION PER IPC-7351B GENERIC REQUIREMENT FOR SURFACE MOUNT DESIGN AND LAND PATTERN.

TOLERANCES UNLESS SPECIFIED		 <b>IDT</b> 6024 Silver Creek Valley Rd San Jose, CA 95138 PHONE: (408) 727-6116 FAX: (408) 492-8674 <a href="http://www.IDT.com">www.IDT.com</a>
DECIMAL	ANGULAR	
XX±	±	
XXX±		
XXXX±		
TITLE		JX6 PACKAGE OUTLINE 3.2 x 2.5 mm BODY 0.9 mm Thick
SIZE	DRAWING No.	REV
C	PSC-4412	01
DO NOT SCALE DRAWING		SHEET 2 OF 2

REVISIONS			
REV	DESCRIPTION	DATE	APPROVED
00	INITIAL RELEASE	10/5/12	KS
01	UPDATE PACKAGE DRWING	8/12/14	JHUA

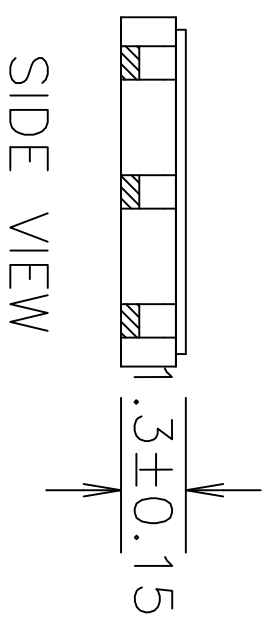
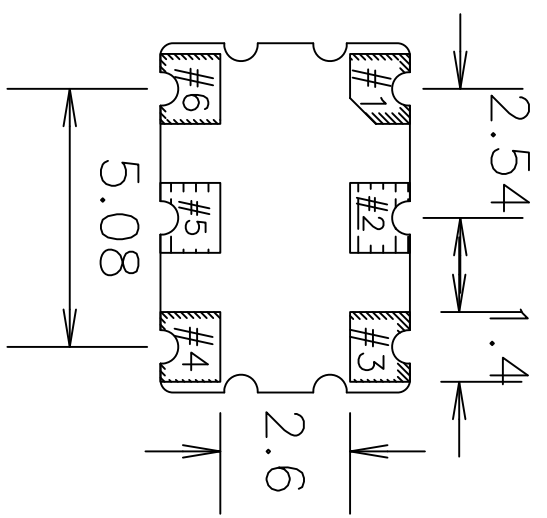
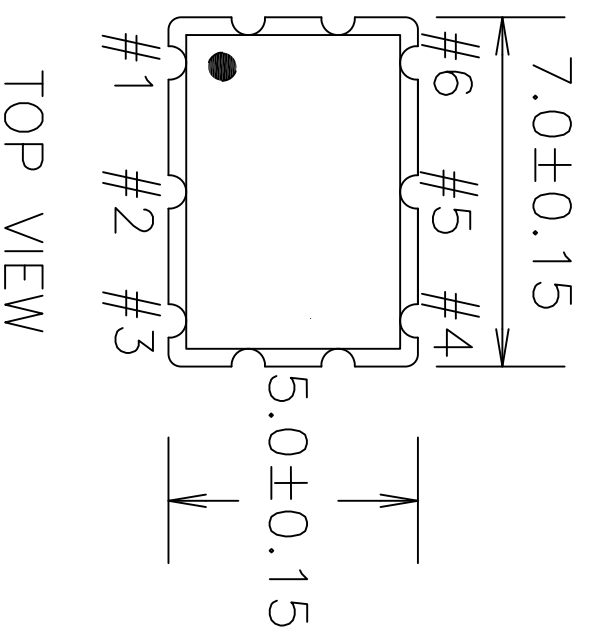

NOTES:  
1. ALL DIMENSIONS IN MM.

TOLERANCES UNLESS SPECIFIED		www.IDT.com	
DECIMAL	ANGULAR	 <b>IDT</b> <sup>TM</sup> 6024 Silver Creek Valley Rd San Jose, CA 95138 PHONE: (408) 727-6116 FAX: (408) 482-9874	
XXX±	±		
XXXX±		TITLE	
XXXX±		JUG PACKAGE OUTLINE	
APPROVALS	DATE	SIZE	DRAWING No.
DRAWN XJS	10/03/12	C	PSC-4430
CHECKED			REV
			01
DO NOT SCALE DRAWING			SHEET 1 OF 2

REVISIONS			
REV	DESCRIPTION	DATE	APPROVED
00	INITIAL RELEASE	10/5/12	KS
01	UPDATE PACKAGE DRAWING	8/12/14	JLHUA

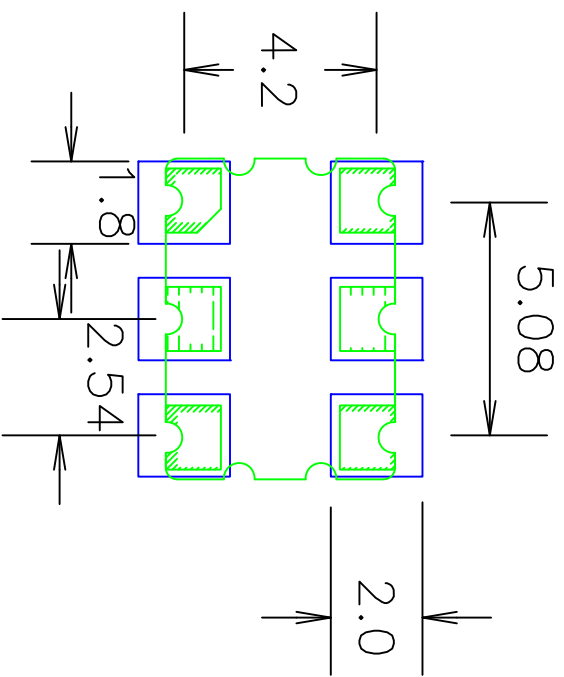

RECOMMENDED LAND PATTERN

- NOTES:
1. ALL DIMENSION ARE IN mm. ANGLES IN DEGREES.
  2. TOP DOWN VIEW. AS VIEWED ON PCB.
  3. COMPONENT OUTLINE SHOW FOR REFERENCE IN PCB.
  4. LAND PATTERN IN BLUE. NSMD PATTERN ASSUMED.
  5. LAND PATTERN RECOMMENDATION PER IPC-7351B. GENERIC REQUIREMENT FOR SURFACE MOUNT DESIGN AND LAND PATTERN.

TOLERANCES UNLESS SPECIFIED		TITLE	
DECIMAL	ANGULAR	J06 PACKAGE OUTLINE	
F	F	7.0 x 5.0 mm BODY	
X.XX		1.3 mm Thick	
X.XXX			
X.XXX			
APPROVALS	DATE	DRAWING No. FSC-4430	
DRAWN	10/03/12	REV 01	
CHECKED		DO NOT SCALE DRAWING	
		SHEET 2 OF 2	



6024 Silver Creek Valley Rd  
San Jose, CA 95138  
PHONE: (408) 757-6116  
FAX: (408) 492-8874  
www.IDT.com

REVISIONS			
REV	DESCRIPTION	DATE	APPROVED
00	INITIAL RELEASE	08/21/12	K. Stahn
01	UPDATED IJD TOLERANCES	12/03/12	K. Stahn
02	UPDATE PACKAGE DRAWING	8/8/14	JHUA

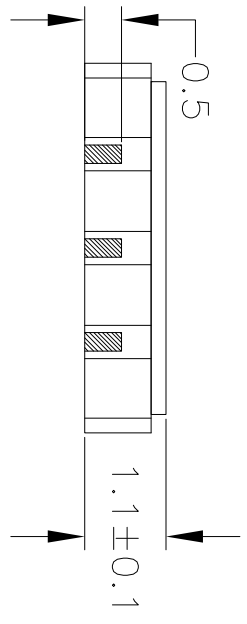
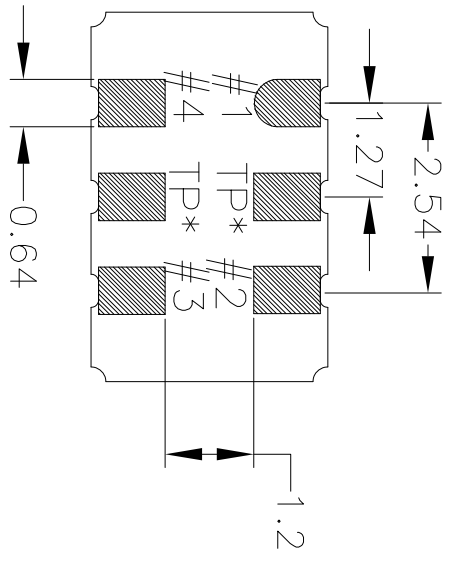
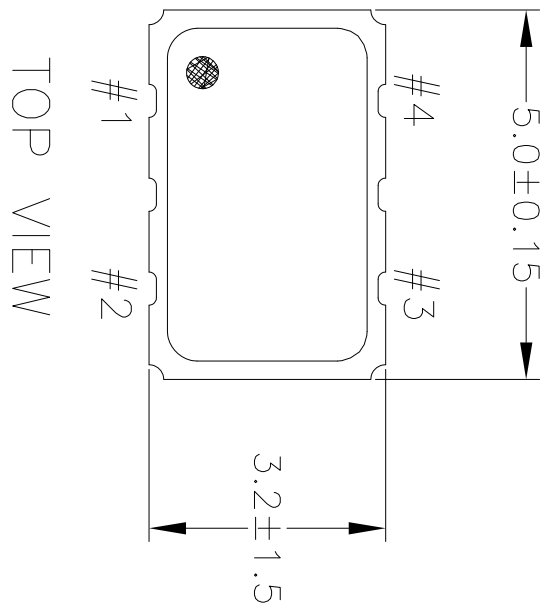

BOTTOM VIEW

TOP VIEW

SIDE VIEW

NOTES:  
1. ALL DIMENSIONS IN MM.

TOLERANCES UNLESS SPECIFIED		6024 Silver Creek Valley Rd	
DECIMAL	ANGULAR	San Jose, CA 95138	
±	F	PHONE: (408) 727-8116	
XXX±		FAX: (408) 492-8574	
XXXX±		www.IDT.com	
APPROVALS		TITLE	
DRAWN	DATE	JS4 PACKAGE OUTLINE	
XXX	07/18/12	5.0 x 3.2 mm BODY	
CHECKED		1.1 mm Thick	
SIZE		DRAWING No.	
C		PSC-4429	
		REV	
		02	
DO NOT SCALE DRAWING			SHEET 1 OF 2

REVISIONS			
REV	DESCRIPTION	DATE	APPROVED
00	INITIAL RELEASE	08/21/12	K. Stahn
01	UPDATED LID TOLERANCES	12/03/12	K. Stahn
02	UPDATE PACKAGE DRAWING	8/8/14	JHUA

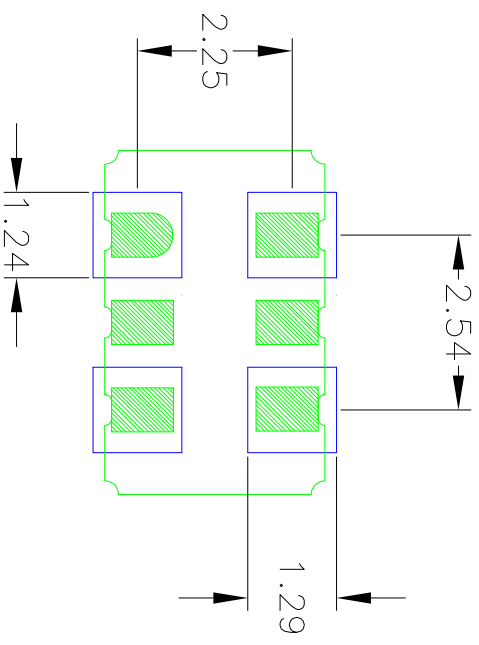

RECOMMENDED LAND PATTERN

- NOTES:
1. ALL DIMENSION ARE IN mm. ANGLES IN DEGREES.
  2. TOP DOWN VIEW. AS VIEWED ON PCB.
  3. COMPONENT OUTLINE SHOW FOR REFERENCE IN GREEN.
  4. LAND PATTERN IN BLUE. NSMD PATTERN ASSUMED.
  5. LAND PATTERN RECOMMENDATION PER IPC-7351B GENERIC REQUIREMENT FOR SURFACE MOUNT DESIGN AND LAND PATTERN.

TOLERANCES UNLESS SPECIFIED		 <b>IDT™</b> 6024 Silver Creek Valley Rd San Jose, CA 95138 PHONE: (408) 727-6118 FAX: (408) 492-8674 www.IDT.com	
DECIMAL	±	ANGULAR	
DATE	07/16/12	DRAWN BY	XXXXX
APPROVALS		CHECKED	
SIZE	C	DRAWING No.	FSC-4429
DO NOT SCALE DRAWING		SHEET	2 OF 2
TITLE	JS4 PACKAGE OUTLINE		
DRIVER	5.0 x 3.2 mm BODY		
THICKNESS	1.1 mm Thick		
REV	02	REV	

REVISIONS			
REV	DESCRIPTION	DATE	APPROVED
00	INITIAL RELEASE	10/09/12	KS
01	UPDATE PACKAGE DRAWING	8/11/14	JHUA

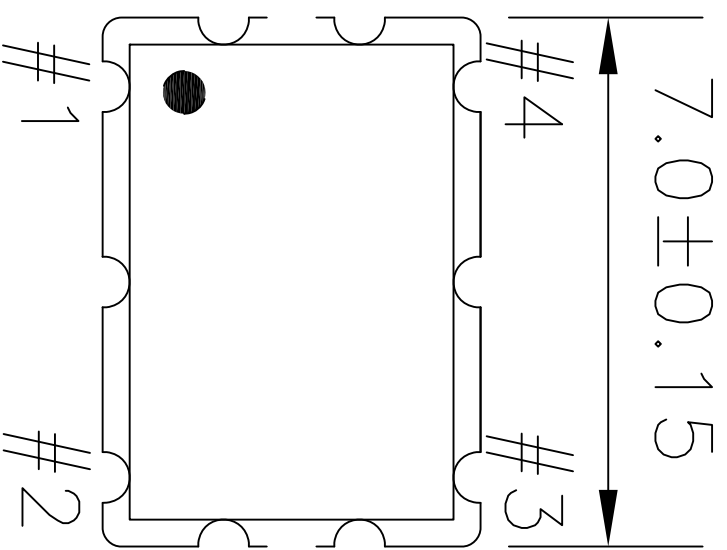

TOP VIEW

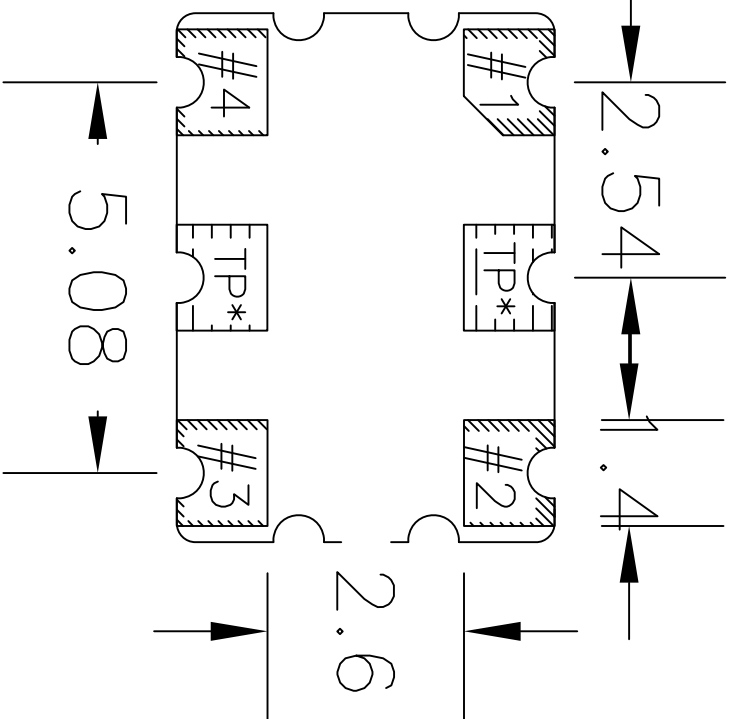
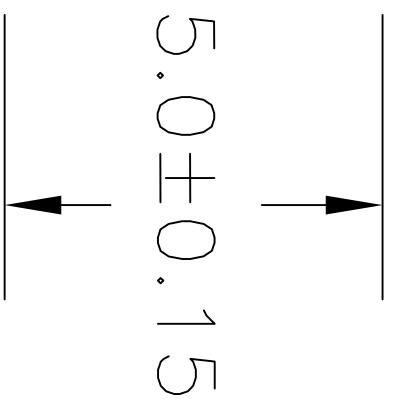

BOTTOM VIEW

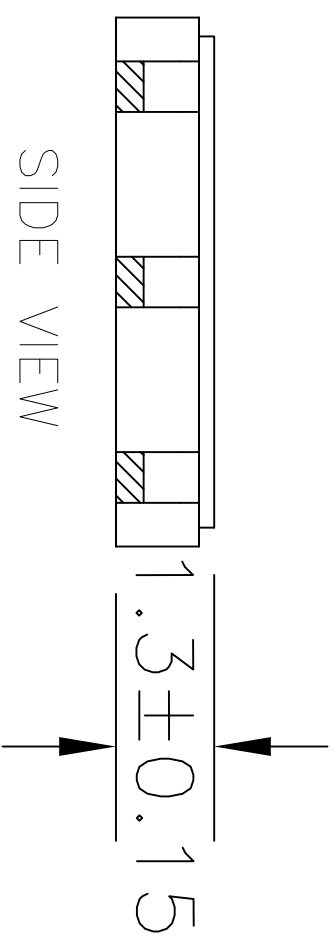

SIDE VIEW

NOTES:  
1. ALL DIMENSIONS IN MM.

TOLERANCES UNLESS SPECIFIED		6024 Silver Creek Valley Rd San Jose, CA 95138	
DECIMAL	±	PHONE: (408) 727-6116	
ANGULAR	±	FAX: (408) 492-8574	
XXX			
XXXX			
XXXXX			
APPROVALS	DATE	TITLE	7.0 x 5.0 mm BODY
DRAWN JCS	10/09/12	JU4 PACKAGE OUTLINE	
CHECKED		1.3 mm Thick	
SIZE	DRAWING NO.	REV	
C	PSC-4431	01	
DO NOT SCALE DRAWING			SHEET 1 OF 2



REVISIONS			
REV	DESCRIPTION	DATE	APPROVED
00	INITIAL RELEASE	10/09/12	KS
01	UPDATE PACKAGE DRAWING	8/11/14	JHUA

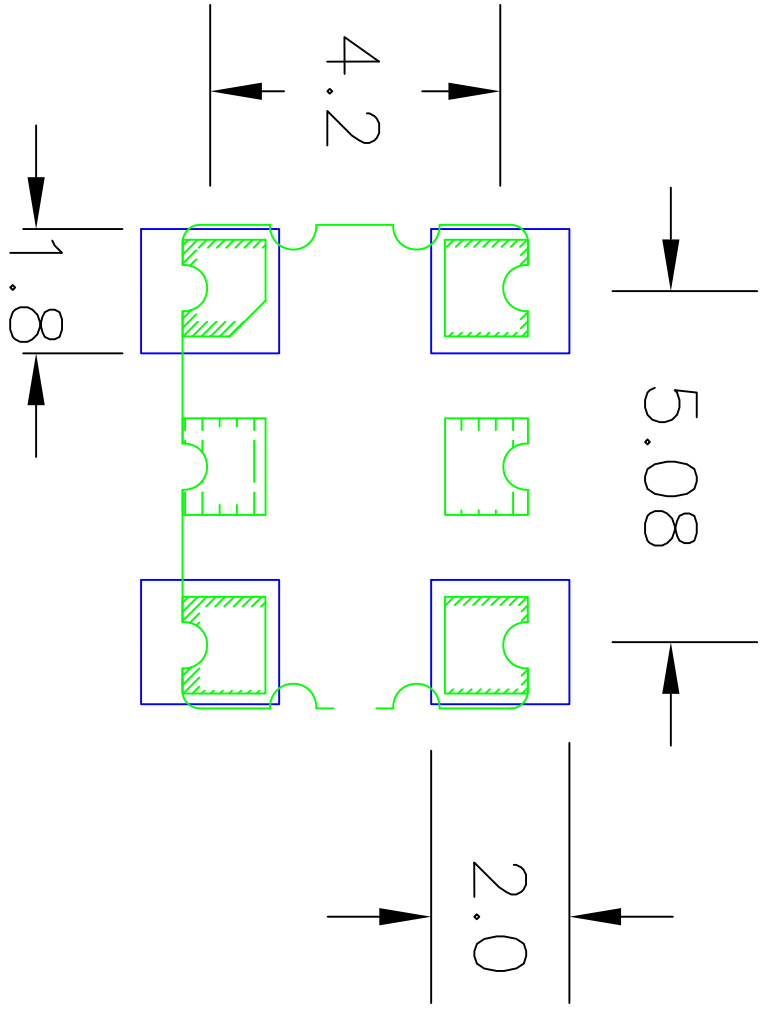

RECOMMENDED LAND PATTERN

- NOTES:
1. ALL DIMENSION ARE IN mm. ANGLES IN DEGREES.
  2. TOP DOWN VIEW. AS VIEWED ON PCB.
  3. COMPONENT OUTLINE SHOW FOR REFERENCE IN GREEN.
  4. LAND PATTERN IN BLUE. NSMD PATTERN ASSUMED.
  5. LAND PATTERN RECOMMENDATION PER IPC-7351B GENERIC REQUIREMENT FOR SURFACE MOUNT DESIGN AND LAND PATTERN.

TOLERANCES UNLESS SPECIFIED		www.IDT.com	
DECIMAL	ANGULAR	6024 Silver Creek Valley Rd San Jose, CA 95138 PHONE: (408) 727-6116 FAX: (408) 492-8674	
XXX±	±	www.IDT.com	
XXXX±		TITLE JU4 PACKAGE OUTLINE	
APPROVALS	DATE	DRAWING No. PSC-4431	
DRAWN %28	10/05/12	SIZE 7.0 x 5.0 mm BODY	
CHECKED		1.3 mm Thick	
		DO NOT SCALE DRAWING	
		REV	01
		SHEET 2 OF 2	

REVISIONS			
REV	DESCRIPTION	DATE	APPROVED
00	INITIAL RELEASE	8/8/14	JHUA
01	ADD OPTION 1 & 2	4/2/15	JHUA

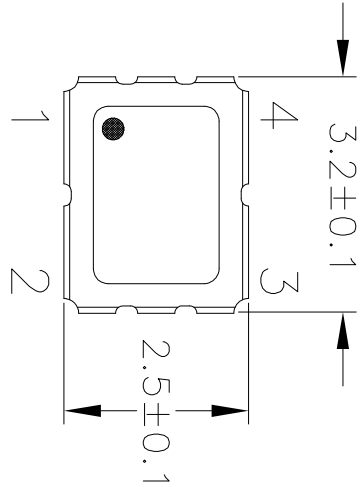

TOP VIEW

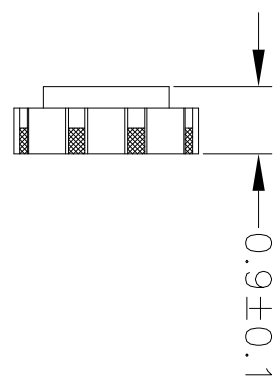

END VIEW

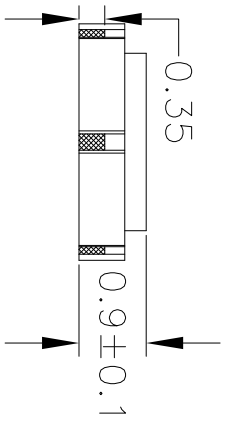

SIDE VIEW

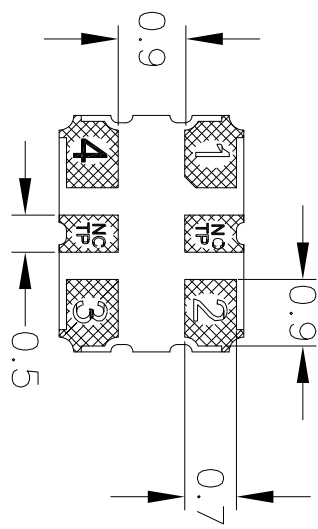

OPTION 1  
BOTTOM VIEW

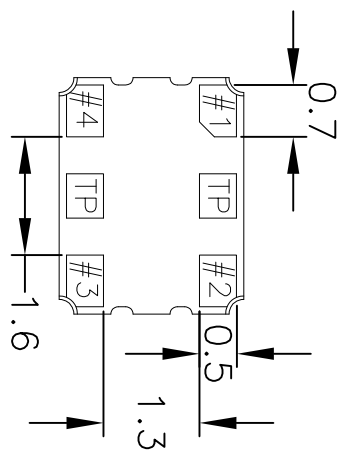

OPTION 2  
BOTTOM VIEW

NOTES:  
1. ALL DIMENSIONS IN MM.

TOLERANCES UNLESS SPECIFIED		 <b>IDT</b> <sup>TM</sup>	6024 Silver Creek Valley Rd San Jose, CA 95138	
DECIMAL	±		PHONE: (408) 727-6116	
XXX			FAX: (408) 492-8674	
XXXX				
APPROVALS	DATE	TITLE	SIZE	
DRAWN <i>RAC</i>	8/8/14	JX4 PACKAGE OUTLINE	3.2 x 2.5 mm BODY	
CHECKED			0.9 mm Thick	
			DRAWING No.	REV
			PSC-4489	01
DO NOT SCALE DRAWING			SHEET 1 OF 2	

REVISIONS			
REV	DESCRIPTION	DATE	APPROVED
00	INITIAL RELEASE	8/8/14	JHUA
01	ADD OPTION 1 & 2	4/2/15	JHUA

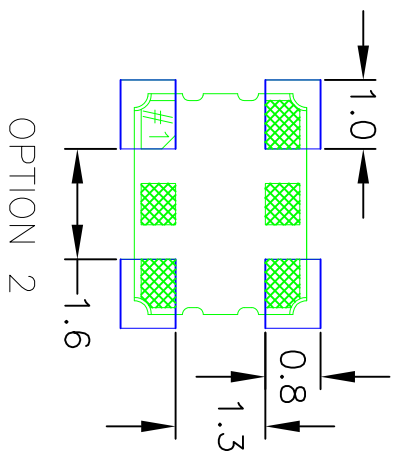
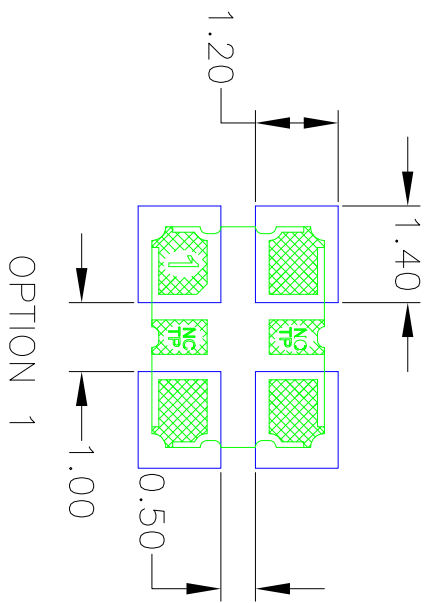

RECOMMENDED LAND PATTERN

- NOTES:
1. ALL DIMENSION ARE IN mm. ANGLES IN DEGREES.
  2. TOP DOWN VIEW AS VIEWED ON PCB.
  3. COMPONENT OUTLINE SHOWN FOR REFERENCE IN GREEN.
  4. LAND PATTERN IN BLUE. NSMD PATTERN ASSUMED.
  5. LAND PATTERN RECOMMENDATION PER IPC-7351B GENERIC REQUIREMENT FOR SURFACE MOUNT DESIGN AND LAND PATTERN.

TOLERANCES UNLESS SPECIFIED	DECIMAL	ANGULAR
XXX±		
XXXX±		
APPROVALS	DATE	TITLE
DRAWN <i>DA/C</i>	8/8/14	JY4 PACKAGE OUTLINE
CHECKED		3.2 x 2.5 mm BODY
		0.9 mm Thick
SIZE	DRAWING No.	REV
C	PSC-4489	01
DO NOT SCALE DRAWING		
SHEET 2 OF 2		

**IDT**  
 6024 Silver Creek Valley Rd  
 San Jose, CA 95138  
 PHONE: (408) 727-6116  
 FAX: (408) 492-8574  
[www.idt.com](http://www.idt.com)