

# RF Power LDMOS Transistors

## N-Channel Enhancement-Mode Lateral MOSFETs

These RF power transistors are designed for pulse applications operating at 1030 to 1090 MHz and can be used over the 960 to 1215 MHz band at reduced power. These devices are suitable for use in defense and commercial pulse applications with large duty cycles and long pulses, such as IFF, secondary surveillance radars, ADS-B transponders, DME and other complex pulse chains.

**Typical Performance:** In 1030–1090 MHz reference circuit,  $I_{DQ(A+B)} = 100 \text{ mA}$

Frequency (MHz) <sup>(1)</sup>	Signal Type	V <sub>DD</sub> (V)	P <sub>out</sub> (W)	G <sub>ps</sub> (dB)	$\eta_D$ (%)
1030	Pulse (128 $\mu\text{sec}$ , 10% Duty Cycle)	50	800 Peak	17.5	52.1
1090			700 Peak	19.0	56.1
1030		52	850 Peak	17.5	51.7
1090			770 Peak	19.2	56.1

**Typical Performance:** In 1030 MHz narrowband production test fixture,  $I_{DQ(A+B)} = 100 \text{ mA}$

Frequency (MHz) <sup>(2)</sup>	Signal Type	V <sub>DD</sub> (V)	P <sub>out</sub> (W)	G <sub>ps</sub> (dB)	$\eta_D$ (%)
1030 <sup>(2)</sup>	Pulse (128 $\mu\text{sec}$ , 10% Duty Cycle)	50	730 Peak	19.2	58.5

### Narrowband Load Mismatch/Ruggedness

Frequency (MHz) <sup>(2)</sup>	Signal Type	VSWR	P <sub>in</sub> (W)	Test Voltage	Result
1030 <sup>(2)</sup>	Pulse (128 $\mu\text{sec}$ , 10% Duty Cycle)	> 20:1 at All Phase Angles	17.2 Peak (3 dB Overdrive)	50	No Device Degradation

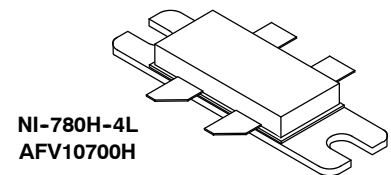
1. Measured in 1030–1090 MHz reference circuit (page 5).
2. Measured in 1030 MHz narrowband production test fixture (page 9).

### Features

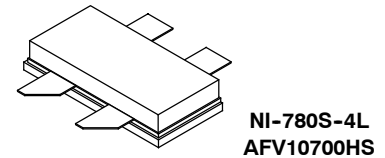
- Internally input and output matched for broadband operation and ease of use
- Device can be used in a single-ended, push-pull or quadrature configuration
- Qualified up to a maximum of 55 V<sub>DD</sub> operation
- High ruggedness, handles > 20:1 VSWR
- Integrated ESD protection with greater negative gate-source voltage range for improved Class C operation and gate voltage pulsing
- Recommended drivers: MRFE6VS25N (25 W) or MRF6V10010N (10 W)
- Included in NXP product longevity program with assured supply for a minimum of 15 years after launch

**AFV10700H**  
**AFV10700HS**  
**AFV10700GS**

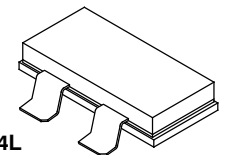
**1030–1090 MHz, 700 W PEAK, 52 V**  
**AIRFAST RF POWER LDMOS**  
**TRANSISTORS**



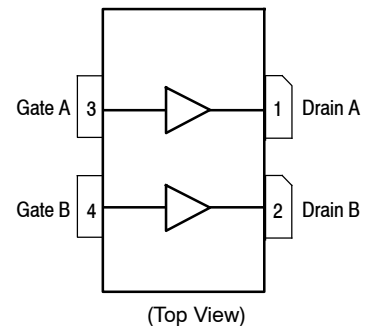
**NI-780H-4L**  
**AFV10700H**



**NI-780S-4L**  
**AFV10700HS**



**NI-780GS-4L**  
**AFV10700GS**



Note: The backside of the package is the source terminal for the transistor.

**Figure 1. Pin Connections**

**Table 1. Maximum Ratings**

Rating	Symbol	Value	Unit
Drain-Source Voltage	$V_{DSS}$	-0.5, +105	Vdc
Gate-Source Voltage	$V_{GS}$	-6.0, +10	Vdc
Operating Voltage	$V_{DD}$	55, +0	Vdc
Storage Temperature Range	$T_{stg}$	-65 to +150	°C
Case Operating Temperature Range	$T_C$	-55 to +150	°C
Operating Junction Temperature Range (1,2)	$T_J$	-55 to +225	°C
Total Device Dissipation @ $T_C = 25^\circ\text{C}$ Derate above 25°C	$P_D$	526 2.63	W W/°C

**Table 2. Thermal Characteristics**

Characteristic	Symbol	Value (2,3)	Unit
Thermal Impedance, Junction to Case Pulse: Case Temperature 75°C, 730 W Peak, 128 $\mu\text{sec}$ Pulse Width, 10% Duty Cycle, 50 Vdc, $I_{DQ(A+B)} = 100\text{ mA}$ , 1030 MHz	$Z_{\theta JC}$	0.030	°C/W

**Table 3. ESD Protection Characteristics**

Test Methodology	Class
Human Body Model (per JESD22-A114)	2, passes 2000 V
Charge Device Model (per JESD22-C101)	C3, passes 2000 V

**Table 4. Electrical Characteristics** ( $T_A = 25^\circ\text{C}$  unless otherwise noted)

Characteristic	Symbol	Min	Typ	Max	Unit
----------------	--------	-----	-----	-----	------

**Off Characteristics (4)**

Gate-Source Leakage Current ( $V_{GS} = 5\text{ Vdc}$ , $V_{DS} = 0\text{ Vdc}$ )	$I_{GSS}$	—	—	1	$\mu\text{Adc}$
Drain-Source Breakdown Voltage ( $V_{GS} = 0\text{ Vdc}$ , $I_D = 10\ \mu\text{A}$ )	$V_{(BR)DSS}$	105	—	—	Vdc
Zero Gate Voltage Drain Leakage Current ( $V_{DS} = 50\text{ Vdc}$ , $V_{GS} = 0\text{ Vdc}$ )	$I_{DSS}$	—	—	1	$\mu\text{Adc}$
Zero Gate Voltage Drain Leakage Current ( $V_{DS} = 105\text{ Vdc}$ , $V_{GS} = 0\text{ Vdc}$ )	$I_{DSS}$	—	—	10	$\mu\text{Adc}$

**On Characteristics**

Gate Threshold Voltage (4) ( $V_{DS} = 10\text{ Vdc}$ , $I_D = 260\ \mu\text{Adc}$ )	$V_{GS(th)}$	1.3	1.8	2.3	Vdc
Gate Quiescent Voltage ( $V_{DD} = 50\text{ Vdc}$ , $I_{DQ(A+B)} = 100\text{ mAdc}$ , Measured in Functional Test)	$V_{GS(Q)}$	1.6	2.1	2.6	Vdc
Drain-Source On-Voltage (4) ( $V_{GS} = 10\text{ Vdc}$ , $I_D = 2.6\text{ Adc}$ )	$V_{DS(on)}$	—	0.28	—	Vdc

**Dynamic Characteristics (4,5)**

Reverse Transfer Capacitance ( $V_{DS} = 50\text{ Vdc} \pm 30\text{ mV(rms)ac}$ @ 1 MHz, $V_{GS} = 0\text{ Vdc}$ )	$C_{rss}$	—	1.16	—	pF
---	-----------	---	------	---	----

1. Continuous use at maximum temperature will affect MTTF.
2. MTTF calculator available at <http://www.nxp.com/RF/calculators>.
3. Refer to AN1955, *Thermal Measurement Methodology of RF Power Amplifiers*. Go to <http://www.nxp.com/RF> and search for AN1955.
4. Each side of device measured separately.
5. Part internally matched both on input and output.

(continued)

**Table 4. Electrical Characteristics** ( $T_A = 25^\circ\text{C}$  unless otherwise noted) (continued)

Characteristic	Symbol	Min	Typ	Max	Unit
<b>Functional Tests</b> (In NXP Narrowband Production Test Fixture, 50 ohm system) $V_{DD} = 50\text{ Vdc}$ , $I_{DQ(A+B)} = 100\text{ mA}$ , $P_{out} = 730\text{ W Peak}$ (73 W Avg.), $f = 1030\text{ MHz}$ , 128 $\mu\text{sec}$ Pulse Width, 10% Duty Cycle					
Power Gain	$G_{ps}$	18.0	19.2	21.0	dB
Drain Efficiency	$\eta_D$	54.5	58.5	—	%
Input Return Loss	IRL	—	-15	-9	dB

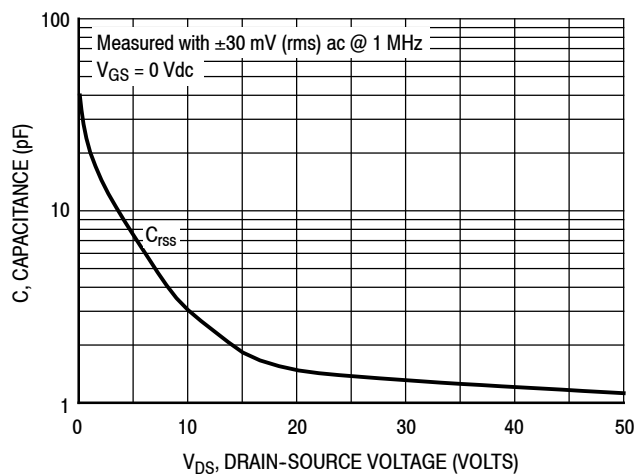
**Load Mismatch/Ruggedness** (In NXP Narrowband Production Test Fixture, 50 ohm system)  $I_{DQ(A+B)} = 100\text{ mA}$ 

Frequency (MHz)	Signal Type	VSWR	$P_{in}$ (W)	Test Voltage, $V_{DD}$	Result
1030	Pulse (128 $\mu\text{sec}$ , 10% Duty Cycle)	> 20:1 at All Phase Angles	17.2 Peak (3 dB Overdrive)	50	No Device Degradation

**Table 5. Ordering Information**

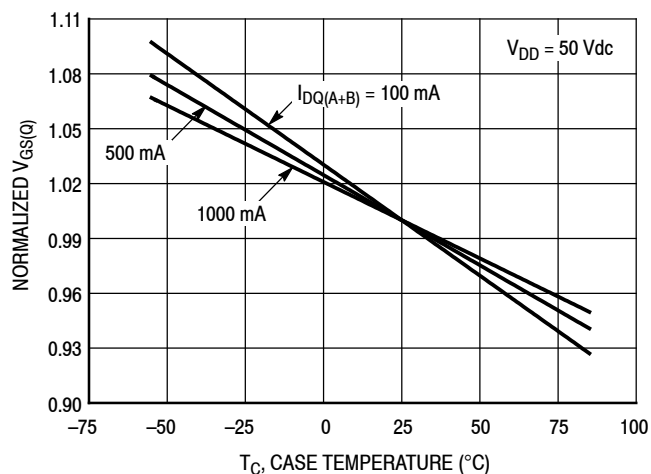
Device	Tape and Reel Information	Package
AFV10700HR5	R5 Suffix = 50 Units, 56 mm Tape Width, 13-inch Reel	NI-780H-4L
AFV10700HSR5	R5 Suffix = 50 Units, 32 mm Tape Width, 13-inch Reel	NI-780S-4L
AFV10700GSR5		NI-780GS-4L

## TYPICAL CHARACTERISTICS



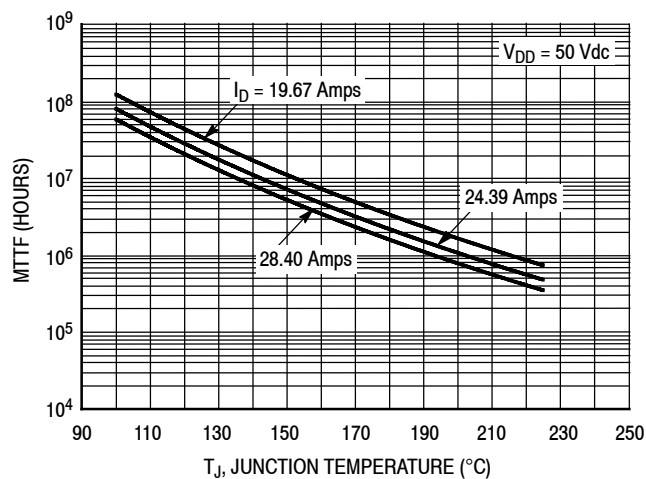
**Note:** Each side of device measured separately.

**Figure 2. Capacitance versus Drain-Source Voltage**



$I_{DQ}$ (mA)	Slope (mV/°C)
100	-2.73
500	-2.39
1500	-2.09

**Figure 3. Normalized  $V_{GS}$  versus Quiescent Current and Case Temperature**



**Note:** MTTF value represents the total cumulative operating time under indicated test conditions.

MTTF calculator available at <http://www.nxp.com/RF/calculators>.

**Figure 4. MTTF versus Junction Temperature – Pulse**

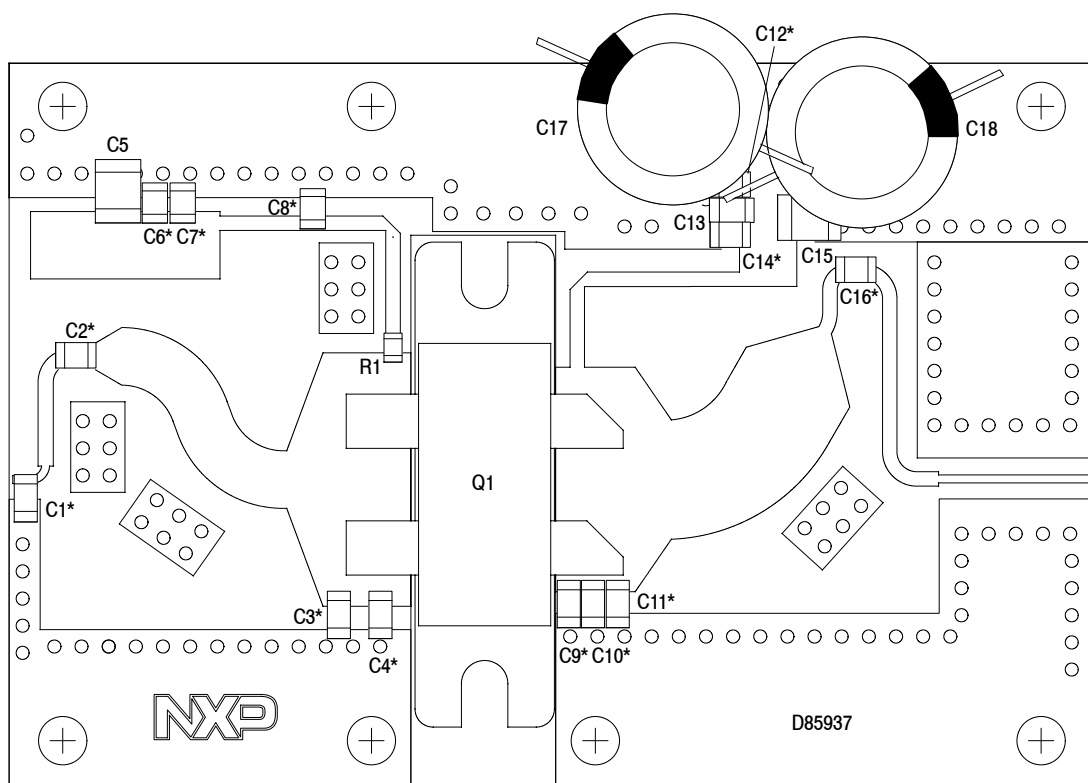
## 1030–1090 MHz REFERENCE CIRCUIT – 2.0" x 3.0" (5.1 cm x 7.6 cm)

**Table 6. 1030–1090 MHz Performance** (In NXP Reference Circuit, 50 ohm system)  $I_{DQ(A+B)} = 100 \text{ mA}$

Frequency (MHz)	Signal Type	V <sub>DD</sub> (V)	P <sub>out</sub> (W)	G <sub>ps</sub> (dB)	$\eta_D$ (%)
1030	Pulse (128 $\mu\text{sec}$ , 10% Duty Cycle)	50	800 Peak	17.5	52.1
1090			700 Peak	19.0	56.1
1030		52	850 Peak	17.5	51.7
1090			770 Peak	19.2	56.1

**NOTE:** Size of the matching area: 1.3" x 2.6" (3.3 cm x 6.6 cm)

1030–1090 MHz REFERENCE CIRCUIT – 2.0" × 3.0" (5.1 cm × 7.6 cm)



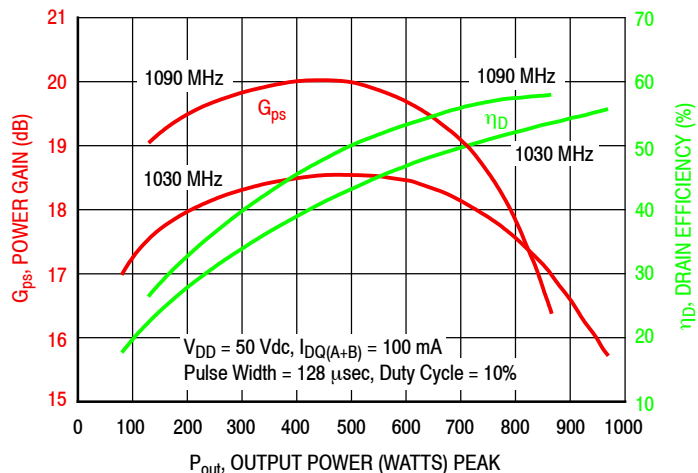
\*C1, C2, C3, C4, C6, C7, C8, C9, C10, C11, C12, C14 and C16 are mounted vertically.

Figure 5. AFV10700H Reference Circuit Component Layout – 1030–1090 MHz

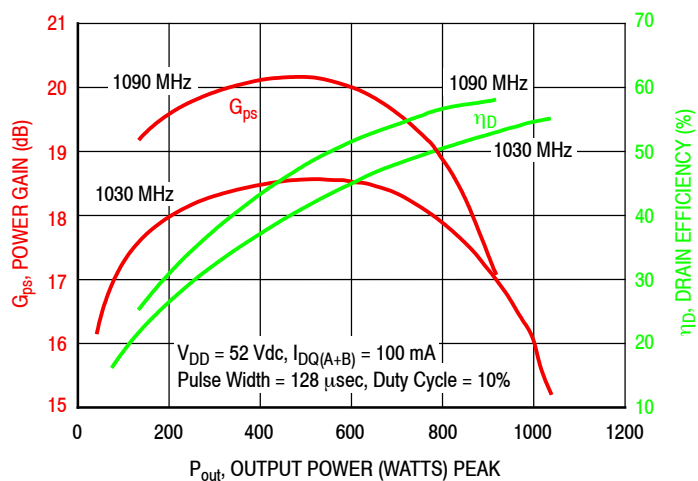
Table 7. AFV10700H Reference Circuit Component Designations and Values – 1030–1090 MHz

Part	Description	Part Number	Manufacturer
C1	1.5 pF Chip Capacitor	ATC800B1R5BT500XT	ATC
C2, C8, C14	39 pF Chip Capacitor	ATC800B390JT500XT	ATC
C3, C4	4.3 pF Chip Capacitor	ATC800B4R3CT500XT	ATC
C5, C15	2.2 $\mu$ F Chip Capacitor	C3225X7R2A225K230AB	TDK
C6, C12	1000 pF Chip Capacitor	ATC800B102JT50XT	ATC
C7	100 pF Chip Capacitor	ATC800B101JT500XT	ATC
C9	4.7 pF Chip Capacitor	ATC800B4R7CT500XT	ATC
C10, C11	3.3 pF Chip Capacitor	ATC800B3R3CT500XT	ATC
C13	1.0 $\mu$ F Chip Capacitor	GRM31CR72A105KA01L	Murata
C16	510 pF Chip Capacitor	ATC800B511JT200XT	ATC
C17, C18	470 $\mu$ F, 63 V Electrolytic Capacitor	MCGPR63V477M13X26–RH	Multicom
Q1	RF High Power LDMOS Transistor	AFV10700H	NXP
R1	10 $\Omega$ , 1/8 W Chip Resistor	RK73H2ATTD10R0F	KAO Speer
PCB	Rogers RO3010 0.025", $\epsilon_r = 11.2$	D85937	MTL

**TYPICAL CHARACTERISTICS – 1030–1090 MHz  
REFERENCE CIRCUIT**

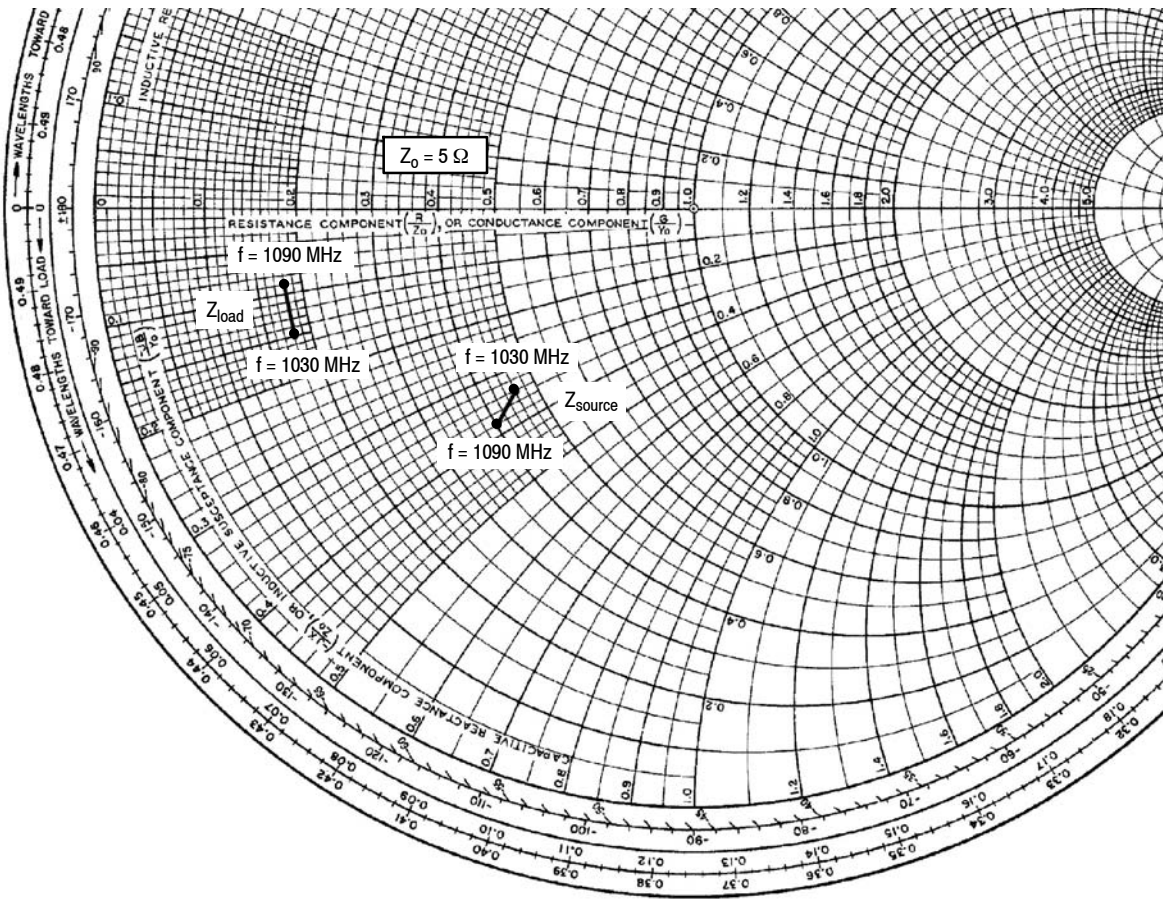


**Figure 6. Power Gain and Drain Efficiency versus Output Power – 50 V**



**Figure 7. Power Gain and Drain Efficiency versus Output Power – 52 V**

### 1030–1090 MHz REFERENCE CIRCUIT



f MHz	Z <sub>source</sub> Ω	Z <sub>load</sub> Ω
1030	2.3 - j1.7	0.91 - j0.76
1090	2.0 - j1.9	0.88 - j0.47

Z<sub>source</sub> = Test circuit impedance as measured from gate to ground.

Z<sub>load</sub> = Test circuit impedance as measured from drain to ground.

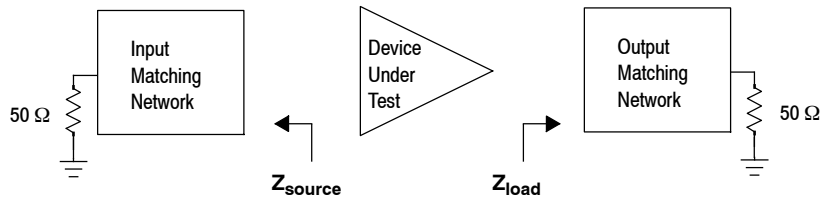
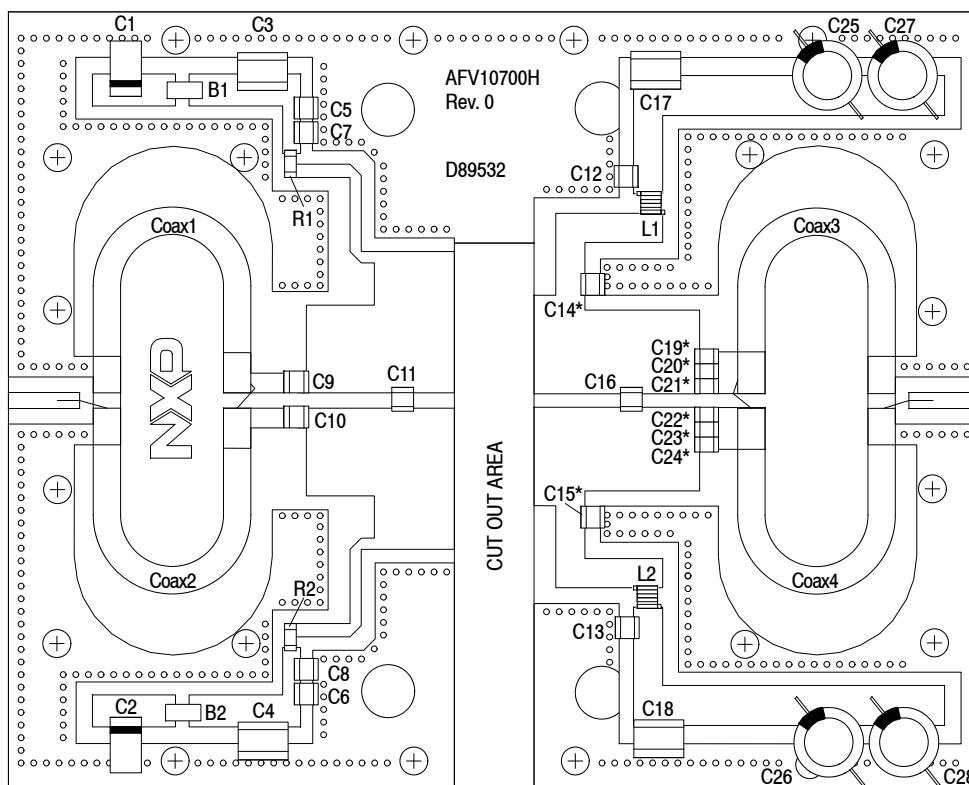


Figure 8. Series Equivalent Source and Load Impedance – 1030–1090 MHz



1030 MHz NARROWBAND PRODUCTION TEST FIXTURE – 4.0" x 5.0" (10.2 cm x 12.7 cm)



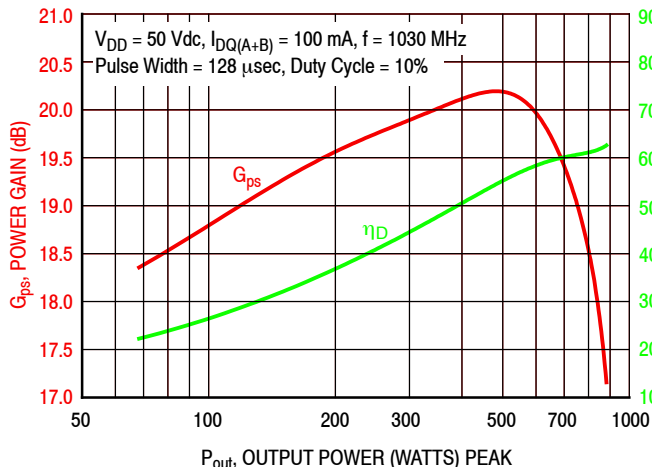
\*C14, C15, C19, C20, C21, C22, C23 and C24 are mounted vertically.

Figure 9. AFV10700H Narrowband Test Circuit Component Layout – 1030 MHz

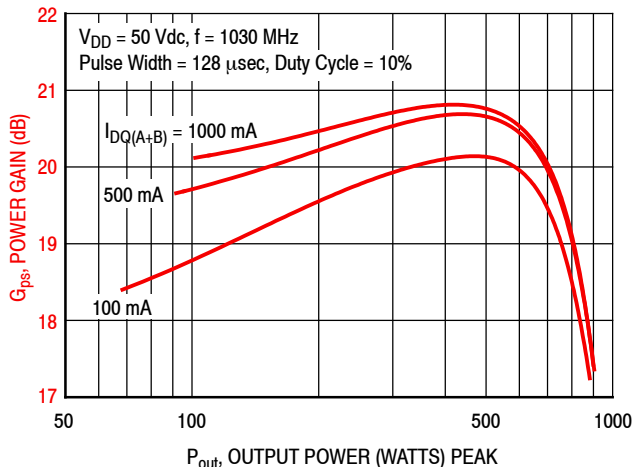
Table 8. AFV10700H Narrowband Test Circuit Component Designations and Values – 1030 MHz

Part	Description	Part Number	Manufacturer
B1, B2	Short RF Bead	2743019447	Fair-Rite
C1, C2	22 $\mu$ F, 35 V Tantalum Capacitor	T491X226K035AT	Kemet
C3, C4	2.2 $\mu$ F Chip Capacitor	C1825C225J5RAC	Kemet
C5, C6	0.1 $\mu$ F Chip Capacitor	CDR33BX104AKWS	AVX
C7, C8, C19, C20, C21, C22, C23, C24	43 pF Chip Capacitor	ATC100B430JT500XT	ATC
C9, C10	3.3 pF Chip Capacitor	ATC100B3R3CT500XT	ATC
C11	0.7 pF Chip Capacitor	ATC100B0R7BT500XT	ATC
C12, C13	36 pF Chip Capacitor	ATC100B360JT500XT	ATC
C14, C15	5.1 pF Chip Capacitor	ATC100B5R1CT500XT	ATC
C16	5.6 pF Chip Capacitor	ATC100B5R6CT500XT	ATC
C17, C18	0.01 $\mu$ F Chip Capacitor	C1825C103K1GACTU	Kemet
C25, C26, C27, C28	470 $\mu$ F, 63 V Electrolytic Capacitor	MCGPR63V477M13X26-RH	Multicomp
Coax1, Coax2, Coax3, Coax4	35 $\Omega$ , Semi Rigid Coax 1.98" Shield Length	HSF-141-35-C	Hongsen Cable
L1, L2	12 nH Inductor, 3 Turns	GA3094-ALC	Coilcraft
R1, R2	5.6 $\Omega$ , 1/4 W Chip Resistor	CRCW12065R60FKEA	Vishay
PCB	Arlon, AD255A, 0.03", $\epsilon_r = 2.55$	D89532	MTL

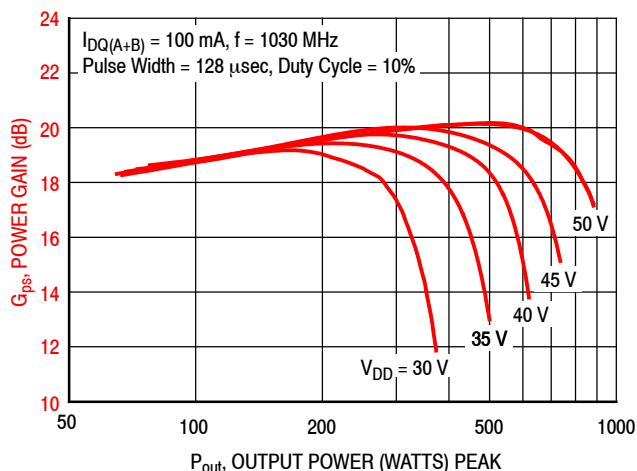
**TYPICAL CHARACTERISTICS – 1030 MHz,  $T_C = 25^\circ\text{C}$   
PRODUCTION TEST FIXTURE**



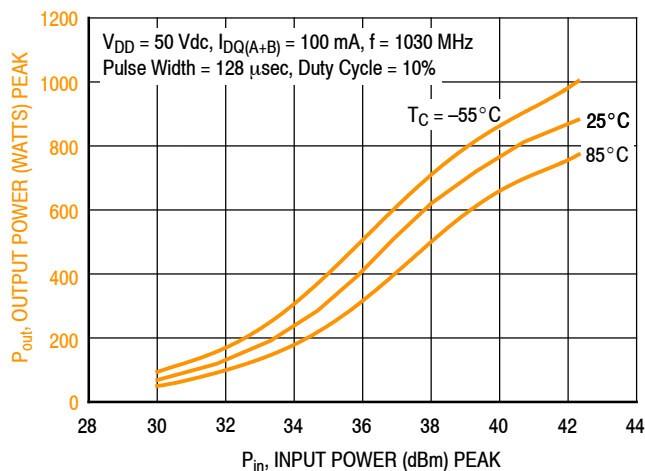
**Figure 10. Power Gain and Drain Efficiency versus Output Power**



**Figure 11. Power Gain versus Output Power and Quiescent Drain Current**

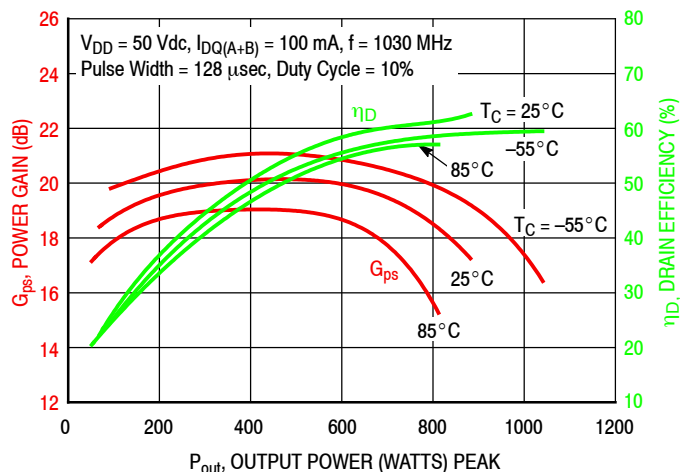


**Figure 12. Power Gain versus Output Power and Drain Voltage**



f (MHz)	P1dB (W)	P3dB (W)
1030	740	883

**Figure 13. Output Power versus Input Power**



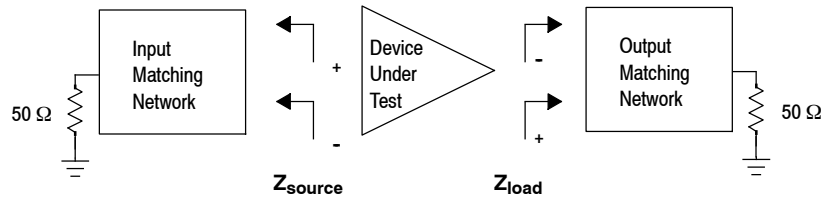
**Figure 14. Power Gain and Drain Efficiency versus Output Power**

## 1030 MHz NARROWBAND PRODUCTION TEST FIXTURE

f MHz	$Z_{\text{source}}$ $\Omega$	$Z_{\text{load}}$ $\Omega$
1030	$4.0 - j6.9$	$3.9 - j1.4$

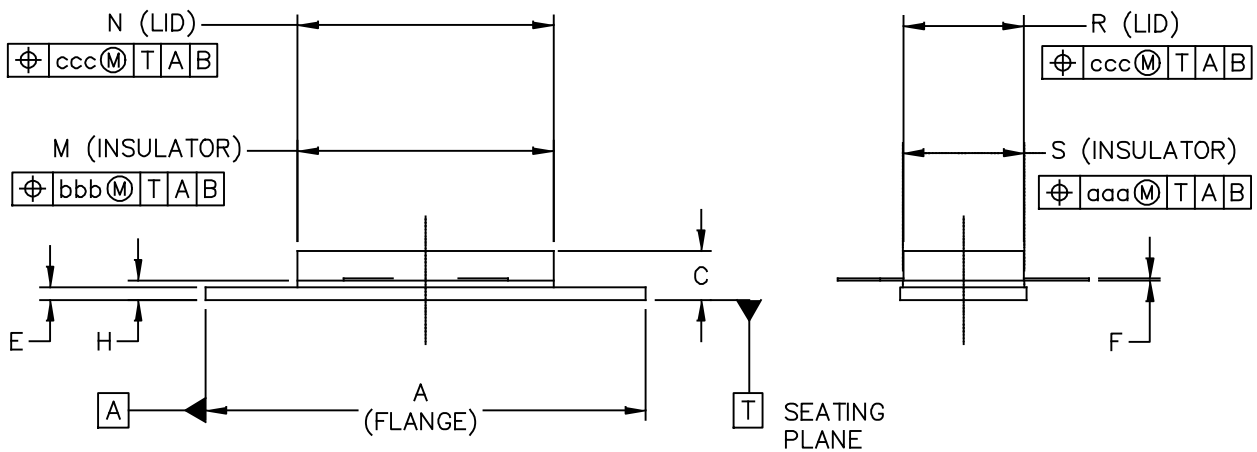
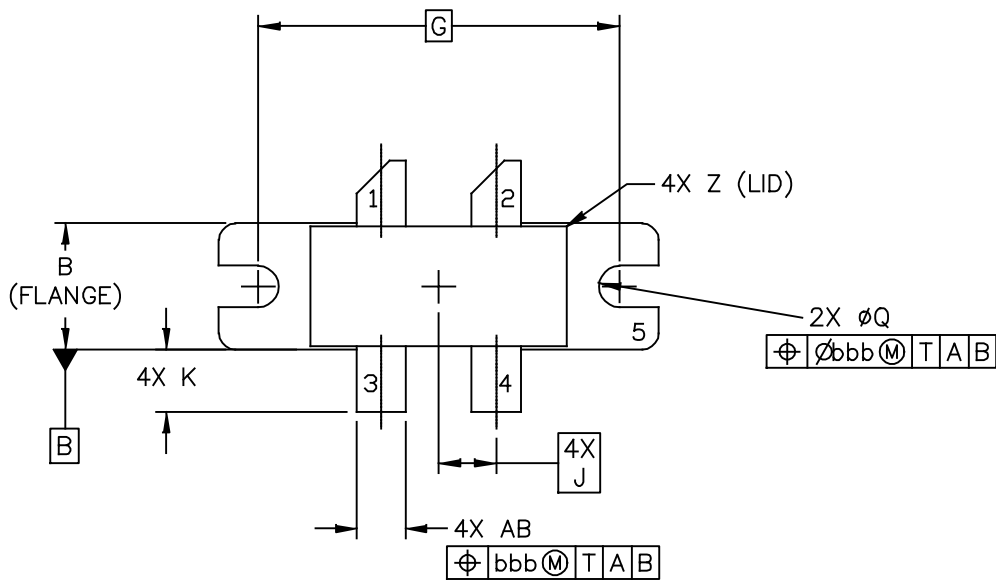
$Z_{\text{source}}$  = Test circuit impedance as measured from gate to gate, balanced configuration.

$Z_{\text{load}}$  = Test circuit impedance as measured from drain to drain, balanced configuration.



**Figure 15. Series Equivalent Source and Load Impedance – 1030 MHz**

### PACKAGE DIMENSIONS



© NXP SEMICONDUCTORS N.V. ALL RIGHTS RESERVED	MECHANICAL OUTLINE	PRINT VERSION NOT TO SCALE
TITLE:  NI 780-4	DOCUMENT NO: 98ASA10793D	REV: A
	STANDARD: NON-JEDEC	
	SOT1827-1	17 MAR 2016

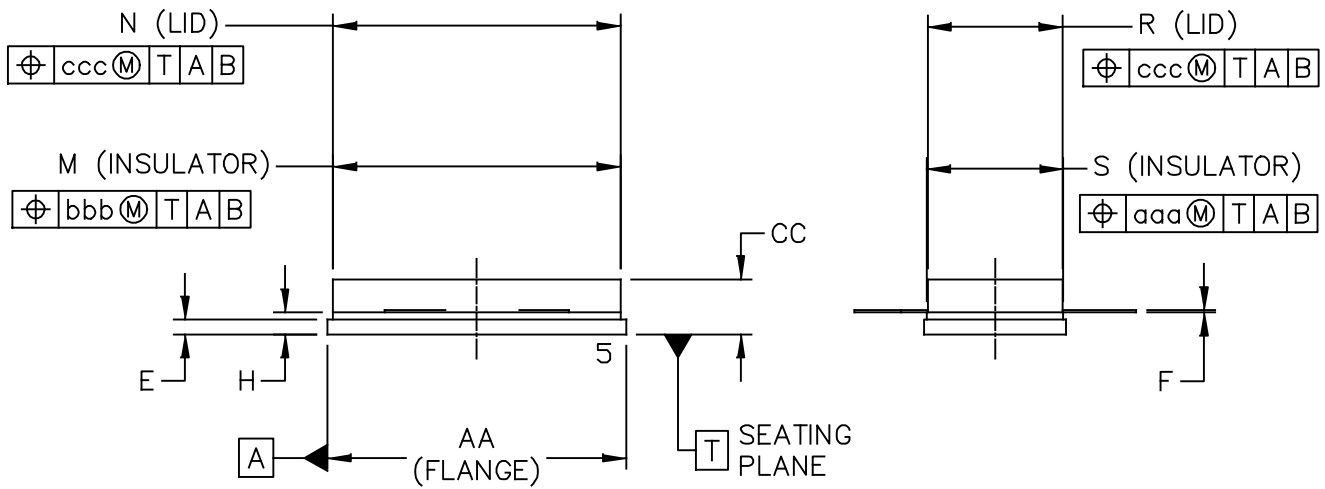
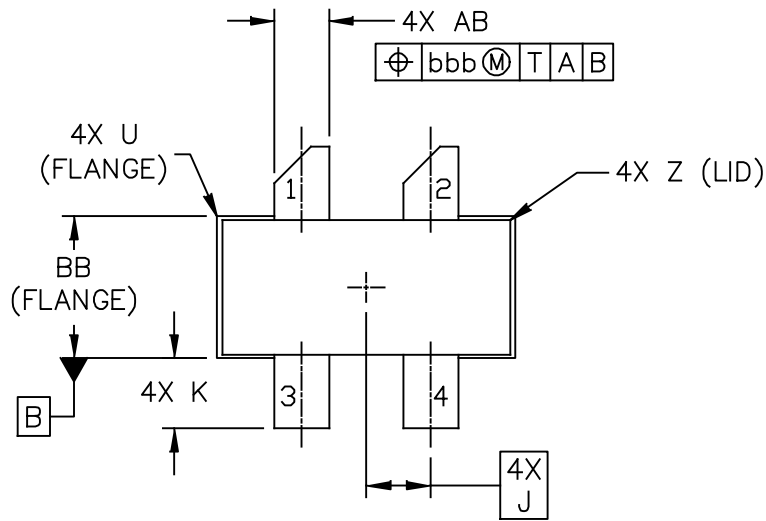
NOTES:

1. DIMENSIONING AND TOLERANCING PER ANSI Y14.5M-1994.
2. CONTROLLING DIMENSION: INCH.
3. DIMENSION H IS MEASURED .030 (0.762) AWAY FROM PACKAGE BODY.

STYLE 1:

- PIN 1. DRAIN  
 2. DRAIN  
 3. GATE  
 4. GATE  
 5. SOURCE

DIM	INCH		MILLIMETER		DIM	INCH		MILLIMETER	
	MIN	MAX	MIN	MAX		MIN	MAX	MIN	MAX
A	1.335	1.345	33.91	34.16	R	.365	.375	9.27	9.53
B	.380	.390	9.65	9.91	S	.365	.375	9.27	9.52
C	.125	.170	3.18	4.32	U		.040		1.02
E	.035	.045	0.89	1.14	Z		.030		0.76
F	.003	.006	0.08	0.15	AB	.145	.155	3.68	3.94
G	1.100 BSC		27.94 BSC						
H	.057	.067	1.45	1.7	aaa		.005		0.127
J	.175 BSC		4.44 BSC		bbb		.010		0.254
K	.170	.210	4.32	5.33	ccc		.015		0.381
M	.774	.786	19.61	20.02					
N	.772	.788	19.61	20.02					
Q	∅.118	∅.138	∅3	∅3.51					
© NXP SEMICONDUCTORS N. V. ALL RIGHTS RESERVED			MECHANICAL OUTLINE			PRINT VERSION NOT TO SCALE			
TITLE:  NI 780-4					DOCUMENT NO: 98ASA10793D      REV: A				
					STANDARD: NON-JEDEC				
					SOT1827-1			17 MAR 2016	

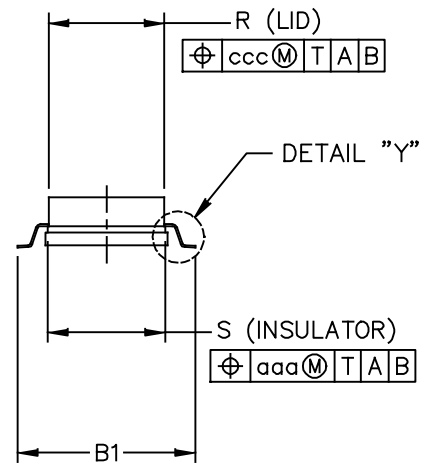
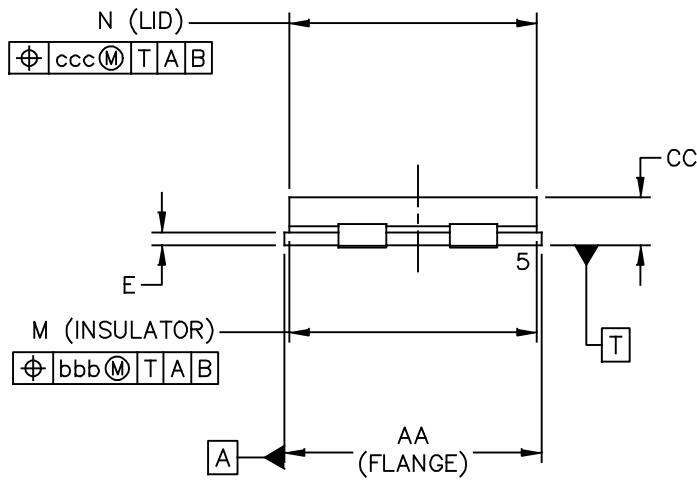
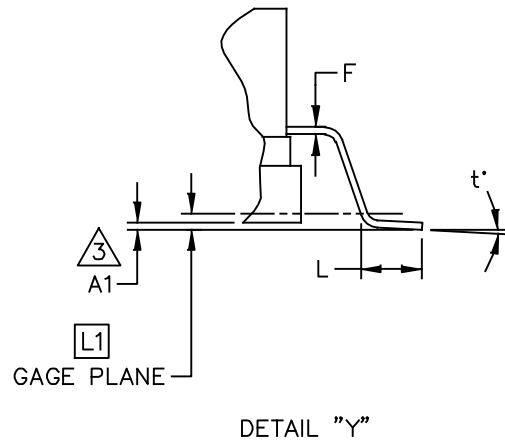
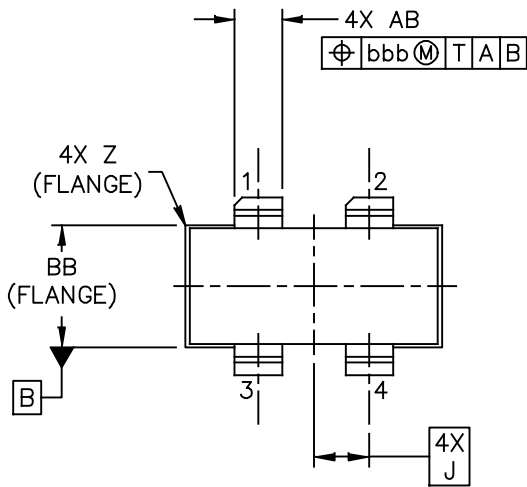


© NXP SEMICONDUCTORS N.V. ALL RIGHTS RESERVED	MECHANICAL OUTLINE	PRINT VERSION NOT TO SCALE
TITLE:  NI-780S-4L	DOCUMENT NO: 98ASA10718D STANDARD: NON-JEDEC SOT1826-1	REV: C  01 AUG 2016

NOTES:

1. DIMENSIONING AND TOLERANCING PER ANSI Y14.5M-1994.
2. CONTROLLING DIMENSION: INCH.
3. DELETED
4. DIMENSION H IS MEASURED .030 (0.762) AWAY FROM FLANGE TO CLEAR EPOXY FLOW OUT PARALLEL TO DATUM B.

DIM	INCH		MILLIMETER		DIM	INCH		MILLIMETER		
	MIN	MAX	MIN	MAX		MIN	MAX	MIN	MAX	
AA	.805	.815	20.45	20.70	U		.040		1.02	
BB	.382	.388	9.70	9.86	Z		.030		0.76	
CC	.125	.170	3.18	4.32	AB	.145	.155	3.68	- 3.94	
E	.035	.045	0.89	1.14						
F	.003	.006	0.08	0.15	aaa		.005		0.127	
H	.057	.067	1.45	1.70	bbb		.010		0.254	
J	.175 BSC		4.44 BSC		ccc		.015		0.381	
K	.170	.210	4.32	5.33						
M	.774	.786	19.61	20.02						
N	.772	.788	19.61	20.02						
R	.365	.375	9.27	9.53						
S	.365	.375	9.27	9.52						
© NXP SEMICONDUCTORS N. V. ALL RIGHTS RESERVED			MECHANICAL OUTLINE			PRINT VERSION NOT TO SCALE				
TITLE:					DOCUMENT NO: 98ASA10718D      REV: C					
NI-780S-4L					STANDARD: NON-JEDEC					
					SOT1826-1		01 AUG 2016			



© NXP SEMICONDUCTORS N.V. ALL RIGHTS RESERVED	MECHANICAL OUTLINE	PRINT VERSION NOT TO SCALE
TITLE:  NI-780GS-4L	DOCUMENT NO: 98ASA00238D STANDARD: NON-JEDEC SOT1805-1	REV: C  23 FEB 2016



NOTES:

1. DIMENSIONING AND TOLERANCING PER ANSI Y14.5M-1994.
2. CONTROLLING DIMENSION: INCH.

3. DIMENSION A1 IS MEASURED WITH REFERENCE TO DATUM T. THE POSITIVE VALUE IMPLIES THAT THE PACKAGE BOTTOM IS HIGHER THAN THE LEAD BOTTOM.

DIM	INCH		MILLIMETER		DIM	INCH		MILLIMETER	
	MIN	MAX	MIN	MAX		MIN	MAX	MIN	MAX
AA	.805	.815	20.45	20.70	Z	R.000	R.040	R0.00	R1.02
A1	.002	.008	0.05	0.20	AB	.145	.155	3.68	3.94
BB	.380	.390	9.65	9.91	t°	0°	8°	0°	8°
B1	.546	.562	13.87	14.27	aaa	.005		0.13	
CC	.125	.170	3.18	4.32	bbb	.010		0.25	
E	.035	.045	0.89	1.14	ccc	.015		0.38	
F	.003	.006	0.08	0.15					
L	.038	.046	0.97	1.17					
L1	.010 BSC		0.25 BSC						
J	.175 BSC		4.44 BSC						
M	.774	.786	19.66	19.96					
N	.772	.788	19.61	20.02					
R	.365	.375	9.27	9.53					
S	.365	.375	9.27	9.53					

© NXP SEMICONDUCTORS N. V. ALL RIGHTS RESERVED		MECHANICAL OUTLINE	PRINT VERSION NOT TO SCALE
TITLE:		DOCUMENT NO: 98ASA00238D	REV: C
NI-780GS-4L		STANDARD: NON-JEDEC	
		SOT1805-1	23 FEB 2016

## PRODUCT DOCUMENTATION, SOFTWARE AND TOOLS

Refer to the following resources to aid your design process.

### Application Notes

- AN1908: Solder Reflow Attach Method for High Power RF Devices in Air Cavity Packages
- AN1955: Thermal Measurement Methodology of RF Power Amplifiers

### Engineering Bulletins

- EB212: Using Data Sheet Impedances for RF LDMOS Devices

### Software

- Electromigration MTTF Calculator
- RF High Power Model
- .s2p File

### Development Tools

- Printed Circuit Boards

### To Download Resources Specific to a Given Part Number:

1. Go to <http://www.nxp.com/RF>
2. Search by part number
3. Click part number link
4. Choose the desired resource from the drop down menu

## REVISION HISTORY

The following table summarizes revisions to this document.

Revision	Date	Description
0	May 2017	<ul style="list-style-type: none"><li>• Initial release of data sheet</li></ul>
1	Jan. 2018	<ul style="list-style-type: none"><li>• Added part number AFV10700GS, p. 1</li><li>• Production test fixture, Typical Characteristic graphs: clarified temperature condition, p. 10</li><li>• Added NI-780GS-4L package isometric, p. 1, and Mechanical Outline, pp. 16–17</li></ul>

### ***How to Reach Us:***

**Home Page:**  
nxp.com

**Web Support:**  
nxp.com/support

Information in this document is provided solely to enable system and software implementers to use NXP products. There are no express or implied copyright licenses granted hereunder to design or fabricate any integrated circuits based on the information in this document. NXP reserves the right to make changes without further notice to any products herein.

NXP makes no warranty, representation, or guarantee regarding the suitability of its products for any particular purpose, nor does NXP assume any liability arising out of the application or use of any product or circuit, and specifically disclaims any and all liability, including without limitation consequential or incidental damages. "Typical" parameters that may be provided in NXP data sheets and/or specifications can and do vary in different applications, and actual performance may vary over time. All operating parameters, including "typicals," must be validated for each customer application by customer's technical experts. NXP does not convey any license under its patent rights nor the rights of others. NXP sells products pursuant to standard terms and conditions of sale, which can be found at the following address: [nxp.com/SalesTermsandConditions](http://nxp.com/SalesTermsandConditions).

NXP, the NXP logo and Airfast are trademarks of NXP B.V. All other product or service names are the property of their respective owners.

© 2017–2018 NXP B.V.

