

REV A	DTP04-2P-C015	REVISIONS		
SYM	DESCRIPTION	DATE	APPROVED	
NC	NEW RELEASE PER E.O. P17140	2/15/01	RDR	
A	REVISED PER E.O. P18081	4-7-03	RDR	

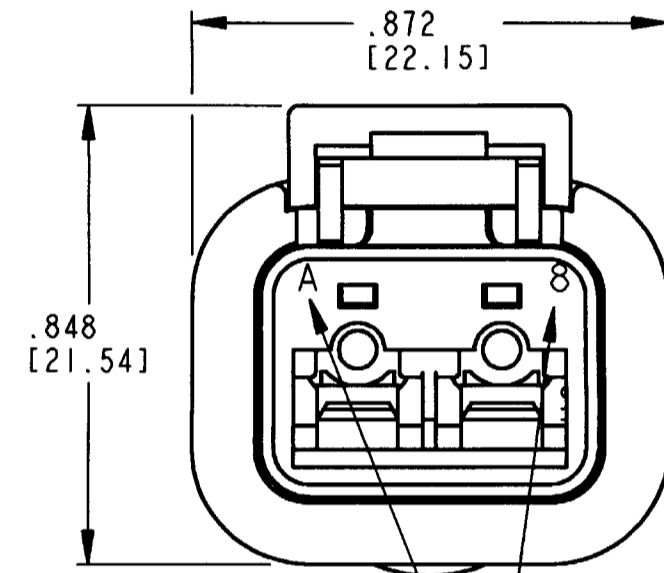

DATE CODE: MONTH IS REPRESENTED BY SEQUENTIAL ALPHA CHARACTERS. EX: A=JANUARY; YEAR IS REPRESENTED BY LAST NUMERICAL DIGIT. EX: 8=2008

- 6. MATERIAL: HOUSING/SLEEVE: PLASTIC
GROMMET/SEAL: RUBBER
 - 5. THIS RECEPTACLE MATES WITH DTP06-2S-**** PLUG.
(**** = ALL MODIFICATIONS)
 - 4. FOR CONTACT AND WIRE PERFORMANCE AND APPLICATION CHARACTERISTICS SEE ENVELOPE DRAWING 0425-015-0000.
 - 3. SECONDARY WEDGE LOCK SOLD SEPARATELY, WP-2P.
 - 2. DIMENSION TOLERANCE: ±.025 [.64].
 - 1. DIMENSIONS ARE IN INCHES [mm].
- NOTES: UNLESS OTHERWISE SPECIFIED

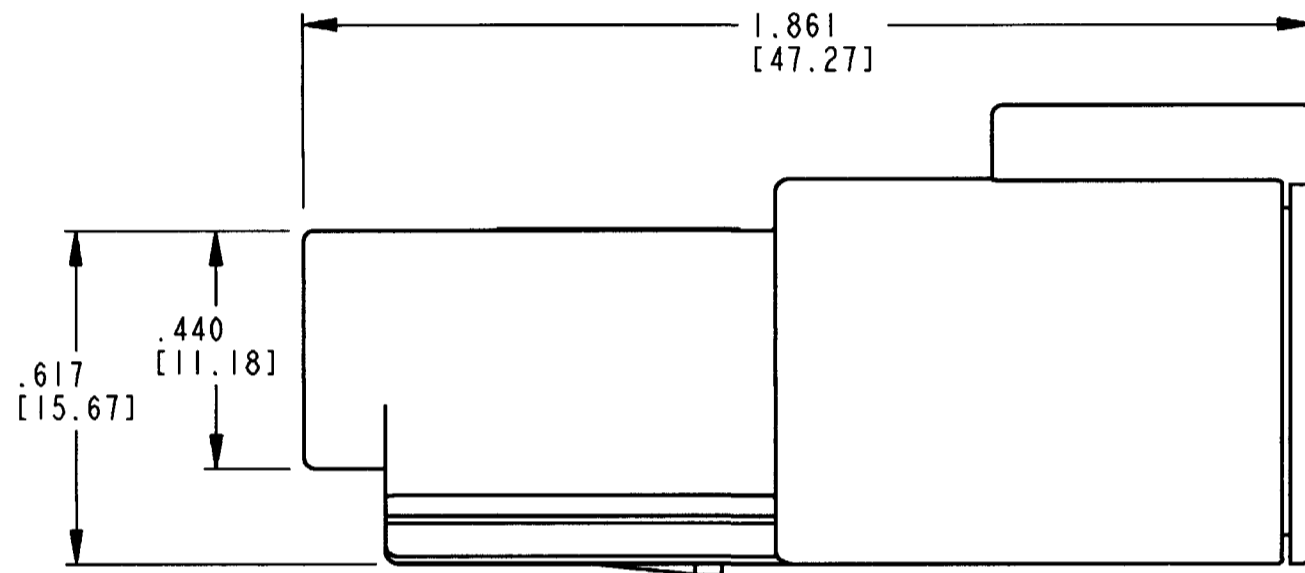
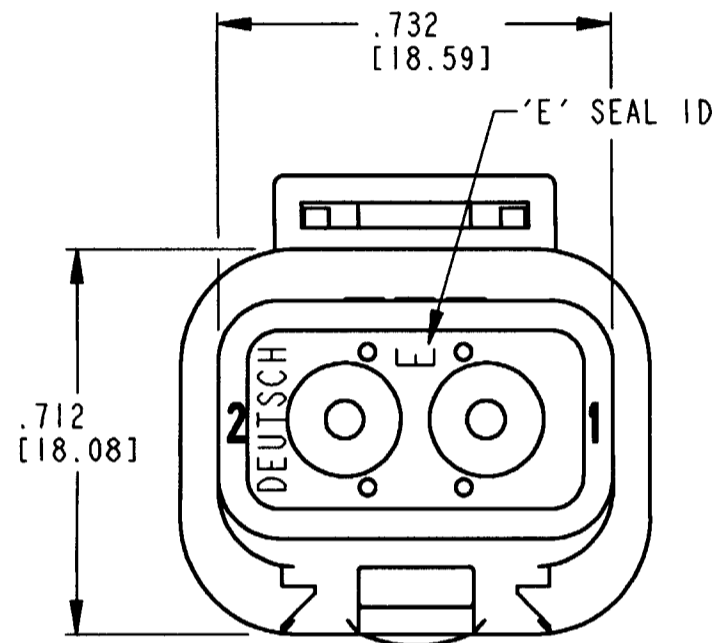
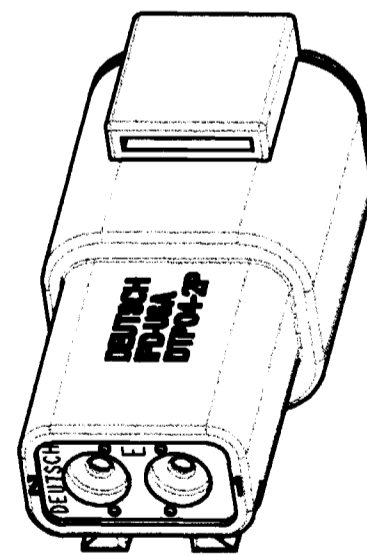

3D VIEW

CONTACT SIZE	MIN. INSUL. O.D.	MAX INSUL. O.D.	WIRE RANGE [mm ²] REF ONLY	4
12	.097 [2.46]	.158 [4.01]	10-14 AWG [5.0-2.0]	

SIGNATURE & DATE		RECEPTACLE 2 WAY, SIZE 12 COLOR: GREY; 'E' SEAL -C015 MOD DTP SERIES ENVELOPE	CP EP107	MATL. CODE
DR	D. MEYER 02/13/01		The Deutsch Company DEUTSCH I.P.D. 3850 INDUSTRIAL AVE. HEMET, CALIF. 92545	
CHK	X. Sanchez 4/4/03		B DTP04-2P-C015	
PE	D. Meyer 4/4/03			
APPD	R. Reed 4-7-03	DWG SIZE	CODE 1139	SHEET 1 OF 1
SCALE	NONE WT			