

PM-25 SERIES PM-45 SERIES PM-65 SERIES

Related Information

- General terms and conditions F-3
- Selection guide P.393~
- Glossary of terms / General precautions.....P.1549~ / P.1552~
- Korea's S-mark..... P.1602

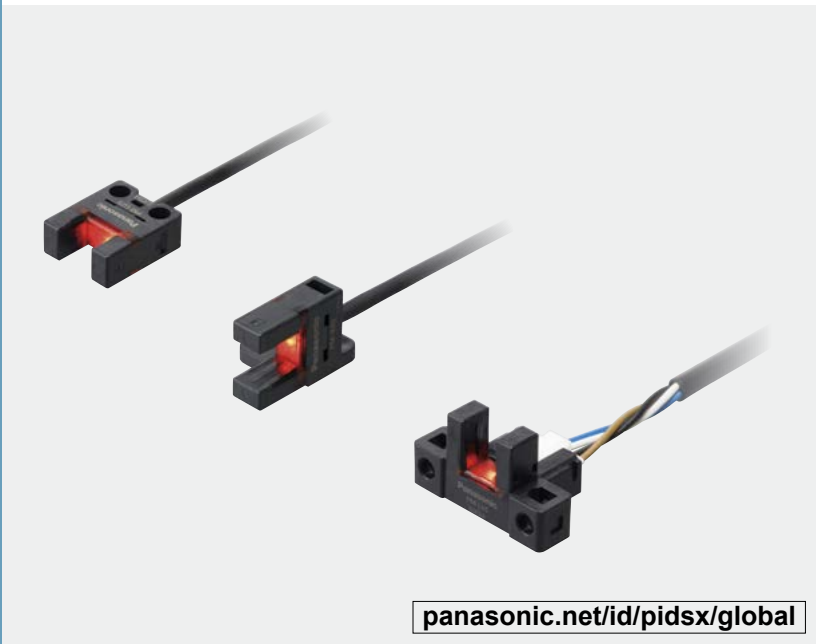

panasonic.net/id/pidsx/global



PNP output type available

One step ahead in performance and mounting ease

Three protection circuits standard on all models **PM-25/45/65 SERIES**

All models are standardly equipped with the following protection circuits in their compact bodies. These protection circuits minimize the possibility of sensor malfunctions caused by erroneous wiring.

- ① Reverse supply polarity protection circuit
- ② Reverse output polarity protection circuit
- ③ Output short-circuit protection circuit

Ample beam emitting / receiving distance of **6 mm 0.236 in** **PM-25/45/65 SERIES**

The beam emitting and receiving sections are 0.5 mm **0.02 in** thinner than those on our conventional models while their external dimensions are the same. As a result, the distance between the beam emitting point and receiving point increased by 1 mm **0.039 in**. The wider distance means less possibility of collision between the sensing section and sensing object.

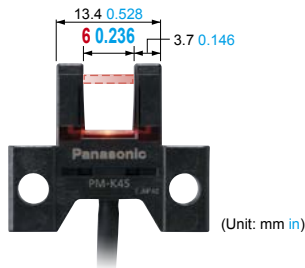

Industry's first*! IP64 rating **PM-25/45 SERIES**

*As of April 2017, in-company survey.

Our original integrated molding method has eliminated grooves and gaps on the sensing surface and main body, thus reducing the possibility of malfunctions caused by splashing water or dust.

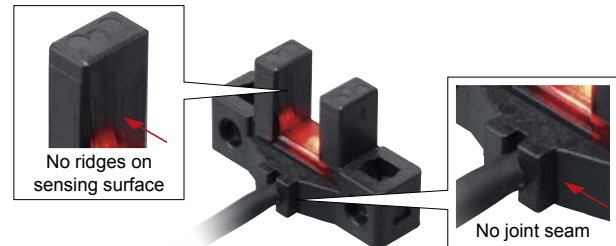

Beam marks for easy adjustment **PM-25/45/65 SERIES**

The upper-limit and lower-limit positions of beam can be visually confirmed from the front, back, right and left sides of the sensor unit. This allows easy adjustment of the position of sensing object.

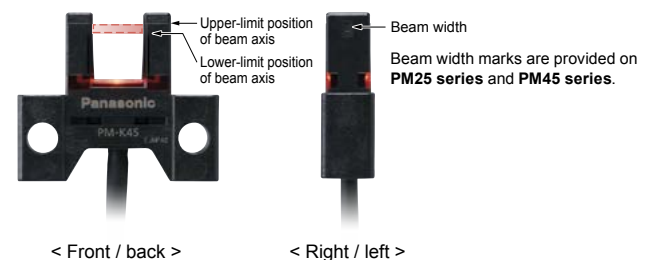

- FIBER SENSORS
- LASER SENSORS
- PHOTOELECTRIC SENSORS
- MICRO PHOTOELECTRIC SENSORS
- AREA SENSORS
- SAFETY LIGHT CURTAINS / SAFETY COMPONENTS
- PRESSURE / FLOW SENSORS
- INDUCTIVE PROXIMITY SENSORS
- PARTICULAR USE SENSORS
- SENSOR OPTIONS
- SIMPLE WIRE-SAVING UNITS
- WIRE-SAVING SYSTEMS
- MEASUREMENT SENSORS
- STATIC CONTROL DEVICES
- LASER MARKERS
- PLC

- HUMAN MACHINE INTERFACES
- ENERGY MANAGEMENT SOLUTIONS
- FA COMPONENTS
- MACHINE VISION SYSTEMS
- UV CURING SYSTEMS

- Selection Guide
- U-shaped
- Convergent Reflective

PM-25/PM-45/PM-65

APPLICATIONS

Positioning of a pallet

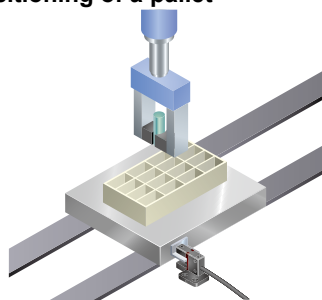

Pallet is stopped by sensing the dog*.

Sensing the starting point and overrun of a moving body

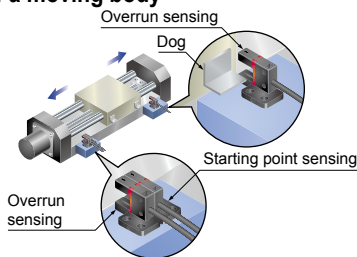

Starting point and overrun is sensed using the dog* on the base.

Sensing the starting point on a rotating body

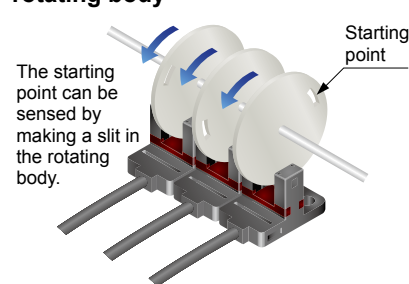

The starting point can be sensed by making a slit in the rotating body.

*"Dog" refers to the sensing object for activating the sensor's detecting operation.

Large and easy to see

Multi-angle operation indicator PM-25/45/65 SERIES

The large operation indicator (orange) lights up when the beam enters. The indicator is easy to see from above and from the sides.

Compact size PM-45 SERIES

All new models require significantly less mounting space than our conventional models when mounted with the same pitch. What's more, the new models can directly replace our conventional models currently in use.

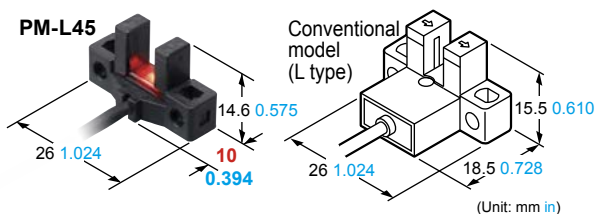

All models easy to mount with M3 screws PM-25/45/65 SERIES

The sensor unit can be installed with one or two M3 screws.
* M3 screws and washers are not included.

- Models requiring one M3 screw for installation **PM-F25, PM-R25, PM-F65, PM-R65**
- Models requiring two M3 screws for installation **Models other than above**

Resistant to vibrations and impacts PM-25/45/65 SERIES

The sections where stress concentrates, such as the connecting section of the cable and internal circuit, are covered with a resin. This helps prevent malfunctions caused by vibrations and impacts.

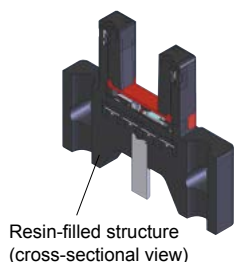

VARIATION

Sensors come in various shapes to suit a wide range of mounting conditions

Ultra-small / Cable type PM-25 SERIES

Easy mounting with M2/M3 screws!

NPN output	1 m 3.281 ft cable	3 m 9.843 ft cable	1 m 3.281 ft bending-resistant cable
PNP output	1 m 3.281 ft cable	3 m 9.843 ft cable	1 m 3.281 ft bending-resistant cable

Compact / Cable type PM-45 SERIES

Compact size!

NPN output	1 m 3.281 ft cable	3 m 9.843 ft cable	1 m 3.281 ft bending-resistant cable
PNP output	1 m 3.281 ft cable	3 m 9.843 ft cable	1 m 3.281 ft bending-resistant cable

Compact / Connector built-in type PM-65 SERIES

Easy connection with a single touch using commercially-available connectors

NPN output	Connector attached cable 1 m 3.281 ft, 2 m 6.562 ft, 3 m 9.843 ft	Connector attached bending-resistant cable 1 m 3.281 ft, 2 m 6.562 ft, 3 m 9.843 ft, 5 m 16.404 ft
PNP output	Connector attached cable 1 m 3.281 ft, 2 m 6.562 ft, 3 m 9.843 ft	Connector attached bending-resistant cable 1 m 3.281 ft, 2 m 6.562 ft, 3 m 9.843 ft, 5 m 16.404 ft

FIBER SENSORS

LASER SENSORS

PHOTO-ELECTRIC SENSORS

MICRO PHOTO-ELECTRIC SENSORS

AREA SENSORS

SAFETY LIGHT CURTAINS / SAFETY COMPONENTS

PRESSURE / FLOW SENSORS

INDUCTIVE PROXIMITY SENSORS

PARTICULAR USE SENSORS

SENSOR OPTIONS

SIMPLE WIRE-SAVING UNITS

WIRE-SAVING SYSTEMS

MEASURE-MENT SENSORS

STATIC CONTROL DEVICES

LASER MARKERS

PLC

HUMAN MACHINE INTERFACES

ENERGY MANAGEMENT SOLUTIONS

FA COMPONENTS

MACHINE VISION SYSTEMS

UV CURING SYSTEMS

Selection Guide

U-shaped

Convergent Reflective

PM-25/PM-45/PM-65

- FIBER SENSORS
- LASER SENSORS
- PHOTO-ELECTRIC SENSORS
- MICRO PHOTO-ELECTRIC SENSORS
- AREA SENSORS
- SAFETY LIGHT CURTAINS / SAFETY COMPONENTS
- PRESSURE / FLOW SENSORS
- INDUCTIVE PROXIMITY SENSORS
- PARTICULAR USE SENSORS
- SENSOR OPTIONS
- SIMPLE WIRE-SAVING UNITS
- WIRE-SAVING SYSTEMS
- MEASUREMENT SENSORS
- STATIC CONTROL DEVICES
- LASER MARKERS
- PLC
- HUMAN MACHINE INTERFACES
- ENERGY MANAGEMENT SOLUTIONS
- FA COMPONENTS
- MACHINE VISION SYSTEMS
- UV CURING SYSTEMS
- Selection Guide
- U-shaped
- Convergent Reflective
- PM-25/PM-45/PM-65

Ultra-small / Cable type PM-25 SERIES

Easy mounting with M2/M3 screws!

Cable type	NPN output	1 m 3.281 ft cable	3 m 9.843 ft cable	1 m 3.281 ft bending-resistant cable
	PNP output	1 m 3.281 ft cable	3 m 9.843 ft cable	1 m 3.281 ft bending-resistant cable



* NPN output / 1 m 3.281 ft cable length type only (Excluding bending-resistant cable type)



ORDER GUIDE

Type	Appearance (mm in)	Sensing range	Model No.	Cable length	Output	Output operation
Ultra-small / Cable type		6 mm 0.236 in (fixed)	PM-K25	1 m 3.281 ft	NPN open-collector transistor	Incorporated with 2 outputs: Light-ON/Dark-ON
			PM-K25-R	1 m 3.281 ft, bending-resistant cable		
			PM-K25-C3	3 m 9.843 ft		
			PM-L25	1 m 3.281 ft	NPN open-collector transistor	
			PM-L25-R	1 m 3.281 ft, bending-resistant cable		
			PM-L25-C3	3 m 9.843 ft		
			PM-U25	1 m 3.281 ft	NPN open-collector transistor	
			PM-U25-R	1 m 3.281 ft, bending-resistant cable		
			PM-U25-C3	3 m 9.843 ft		
			PM-F25	1 m 3.281 ft	NPN open-collector transistor	
			PM-F25-R	1 m 3.281 ft, bending-resistant cable		
			PM-F25-C3	3 m 9.843 ft		
	PM-R25	1 m 3.281 ft	NPN open-collector transistor			
	PM-R25-R	1 m 3.281 ft, bending-resistant cable				
	PM-R25-C3	3 m 9.843 ft				
			PM-R25-P	1 m 3.281 ft	PNP open-collector transistor	

Note: The suffix “-R” in the model No. indicates a bending-resistant cable type. The suffix “-C3” indicates a 3 m 9.843 ft cable length type.

OPTIONS

Designation	Model No.	Description
Mounting screw	MS-M2	Mounting screw with washers for the ultra-small type sensor (50 pcs. lot). It can mount securely as it is spring washer attached.

Mounting screw

- MS-M2

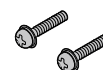

M2 (length 10 mm 0.394 in) screw with a spring washer

SPECIFICATIONS

Item	Model No.	Type	Ultra-small / Cable type		
				Bending-resistant cable	3 m 9.843 ft cable
		NPN output	PM-□25	PM-□25-R	PM-□25-C3
		PNP output	PM-□25-P		
CE marking directive compliance			EMC Directive, RoHS Directive		
Sensing range			6 mm 0.236 in (fixed)		
Minimum sensing object			0.8 × 1.2 mm 0.031 × 0.047 in opaque object		
Hysteresis			0.05 mm 0.002 in or less		
Repeatability			0.01 mm 0.0004 in or less		
Supply voltage			5 to 24 V DC ±10 % Ripple P-P 10 % or less		
Current consumption			15 mA or less		
Output		<NPN output type> NPN open-collector transistor <ul style="list-style-type: none"> • Maximum sink current: 50 mA • Applied voltage: 30 V DC or less (between output and 0 V) • Residual voltage: 2 V or less (at 50 mA sink current) 1 V or less (at 16 mA sink current) 	<PNP output type> PNP open-collector transistor <ul style="list-style-type: none"> • Maximum source current: 50 mA • Applied voltage: 30 V DC or less (between output and +V) • Residual voltage: 2 V or less (at 50 mA source current) 1 V or less (at 16 mA source current) 		
	Output operation	Incorporated with 2 outputs: Light-ON/Dark-ON			
	Short-circuit protection	Incorporated			
Response time			Under light received condition: 20 μs or less Under light interrupted condition: 80 μs or less (Maximum response frequency: 3 kHz) (Note 2)		
Operation indicator			Orange LED (lights up under light received condition)		
Pollution degree			3		
Environmental resistance	Protection	IP64 (IEC)			
	Ambient temperature (Note 3, 4)	-25 to +55 °C -13 to +131 °F (No dew condensation or icing allowed), Storage: -30 to +80 °C -22 to +176 °F			
	Ambient humidity	5 to 85 % RH, Storage: 5 to 95 % RH			
	Ambient illuminance	Fluorescent light: 1,000 lx or less at the light-receiving face			
	Voltage withstandability	1,000 V AC for one min. between all supply terminals connected together and enclosure			
	Insulation resistance	20 MΩ, or more, with 250 V DC megger between all supply terminals connected together and enclosure			
	Vibration resistance	10 to 2,000 Hz frequency, 1.5 mm 0.059 in double amplitude (maximum acceleration 196 m/s ²) in X, Y and Z directions for two hours each			
Shock resistance	15,000 m/s ² acceleration (1,500 G approx.) in X, Y and Z directions three times each				
Emitting element			Infrared LED (Peak emission wavelength: 855 nm 0.034 mil, non-modulated)		
Material			Enclosure: PBT, Display section: Polycarbonate		
Cable	0.09 mm ² 4-core cabtyre cable, PVC, 1 m 3.281 ft long	0.1 mm ² 4-core bending-resistant cabtyre cable, PVC, 1 m 3.281 ft long (Note 5, 6)	0.09 mm ² 4-core cabtyre cable, PVC, 3 m 9.843 ft long		
Cable extension	Extension up to total 100 m 328.084 ft is possible with 0.3 mm ² , or more, cable. (Note 7)				
Weight	Net weight: 10 g approx., Gross weight: 15 g approx.			Net weight: 30 g approx., Gross weight: 35 g approx.	

Notes: 1) Where measurement conditions have not been specified precisely, the conditions used were an ambient temperature of +23 °C +73.4 °F.
2) The response frequency is the value when the disc, given in the figure below, is rotated.

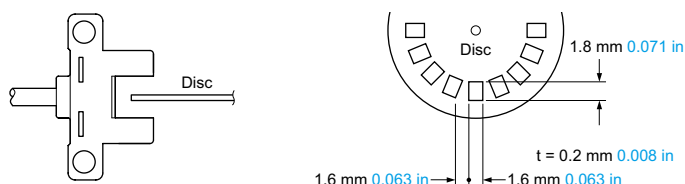

- 3) In case the **PM-25** series is used at an ambient temperature of +50 °C +122 °F, or more, make sure to mount it on a metal body.
- 4) Note that the cable of **PM-□25-R** loses its flexibility when the ambient temperature decreases to about -10 °C +14 °F.
- 5) The cable of **PM-□25-R** is a bending-resistant cable usable on a moving base. When the sensor is mounted on a moving base, secure the sensor cable joint at the unit in place so that stress is not applied to it.
- 6) When storing **PM-□25-R**, make sure that the cable does not come into contact with the sensing section or operation indicator.
- 7) If the cable is extended to 20 m 65.617 ft or longer, confirm that the supply voltage at the end of the cable attached to the sensor is 4.5 V or higher.

FIBER SENSORS

LASER SENSORS

PHOTO-ELECTRIC SENSORS

MICRO PHOTO-ELECTRIC SENSORS

AREA SENSORS

SAFETY LIGHT CURTAINS / SAFETY COMPONENTS

PRESSURE / FLOW SENSORS

INDUCTIVE PROXIMITY SENSORS

PARTICULAR USE SENSORS

SENSOR OPTIONS

SIMPLE WIRE-SAVING UNITS

WIRE-SAVING SYSTEMS

MEASUREMENT SENSORS

STATIC CONTROL DEVICES

LASER MARKERS

PLC

HUMAN MACHINE INTERFACES

ENERGY MANAGEMENT SOLUTIONS

FA COMPONENTS

MACHINE VISION SYSTEMS

UV CURING SYSTEMS

Selection Guide

U-shaped

Convergent Reflective

PM-25/PM-45/PM-65

- FIBER SENSORS
- LASER SENSORS
- PHOTO-ELECTRIC SENSORS
- MICRO PHOTO-ELECTRIC SENSORS
- AREA SENSORS
- SAFETY LIGHT CURTAINS / SAFETY COMPONENTS
- PRESSURE / FLOW SENSORS
- INDUCTIVE PROXIMITY SENSORS
- PARTICULAR USE SENSORS
- SENSOR OPTIONS
- SIMPLE WIRE-SAVING UNITS
- WIRE-SAVING SYSTEMS
- MEASUREMENT SENSORS
- STATIC CONTROL DEVICES
- LASER MARKERS
- PLC
- HUMAN MACHINE INTERFACES
- ENERGY MANAGEMENT SOLUTIONS
- FA COMPONENTS
- MACHINE VISION SYSTEMS
- UV CURING SYSTEMS
- Selection Guide
- U-shaped
- Convergent Reflective
- PM-25/PM-45/PM-65

Compact / Cable type PM-45 SERIES

Compact size!

Cable type	NPN output	1 m 3.281 ft cable	3 m 9.843 ft cable	1 m 3.281 ft bending-resistant cable
	PNP output	1 m 3.281 ft cable	3 m 9.843 ft cable	1 m 3.281 ft bending-resistant cable



* NPN output / 1 m 3.281 ft cable length type only



ORDER GUIDE

Type	Appearance (mm in)	Sensing range	Model No.	Cable length	Output	Output operation
Compact / Cable type		6 mm 0.236 in (fixed)	PM-K45	1 m 3.281 ft	NPN open-collector transistor	Incorporated with 2 outputs: Light-ON/Dark-ON
			PM-K45-C3	3 m 9.843 ft		
			PM-K45-P	1 m 3.281 ft	PNP open-collector transistor	
			PM-K45-P-C3	3 m 9.843 ft		
			PM-T45	1 m 3.281 ft	NPN open-collector transistor	
			PM-T45-C3	3 m 9.843 ft		
			PM-T45-P	1 m 3.281 ft	PNP open-collector transistor	
			PM-T45-P-C3	3 m 9.843 ft		
			PM-L45	1 m 3.281 ft	NPN open-collector transistor	
			PM-L45-C3	3 m 9.843 ft		
			PM-L45-P	1 m 3.281 ft	PNP open-collector transistor	
			PM-L45-P-C3	3 m 9.843 ft		
			PM-Y45	1 m 3.281 ft	NPN open-collector transistor	
			PM-Y45-C3	3 m 9.843 ft		
			PM-Y45-P	1 m 3.281 ft	PNP open-collector transistor	
			PM-Y45-P-C3	3 m 9.843 ft		
			PM-F45	1 m 3.281 ft	NPN open-collector transistor	
			PM-F45-C3	3 m 9.843 ft		
PM-F45-P		1 m 3.281 ft	PNP open-collector transistor			
PM-F45-P-C3		3 m 9.843 ft				
	PM-R45	1 m 3.281 ft	NPN open-collector transistor			
	PM-R45-C3	3 m 9.843 ft				
	PM-R45-P	1 m 3.281 ft	PNP open-collector transistor			
	PM-R45-P-C3	3 m 9.843 ft				

Note: The suffix "-C3" in the model No. indicates a 3 m 9.843 ft cable length type.

SPECIFICATIONS

Item	Model No.	Type	Compact / Cable type	
		NPN output	PM-□45	3 m 9.843 ft cable PM-□45-C3
		PNP output	PM-□45-P	PM-□45-P-C3
CE marking directive compliance		EMC Directive, RoHS Directive		
Sensing range		6 mm 0.236 in (fixed)		
Minimum sensing object		0.8 × 1.2 mm 0.031 × 0.047 in opaque object		
Hysteresis		0.05 mm 0.002 in or less		
Repeatability		0.01 mm 0.0004 in or less		
Supply voltage		5 to 24 V DC ±10 % Ripple P-P 10 % or less		
Current consumption		15 mA or less		
Output		<NPN output type> NPN open-collector transistor		<PNP output type> PNP open-collector transistor
		<ul style="list-style-type: none"> Maximum sink current: 50 mA Applied voltage: 30 V DC or less (between output and 0 V) Residual voltage: 2 V or less (at 50 mA sink current) 1 V or less (at 16 mA sink current) 		<ul style="list-style-type: none"> Maximum source current: 50 mA Applied voltage: 30 V DC or less (between output and +V) Residual voltage: 2 V or less (at 50 mA source current) 1 V or less (at 16 mA source current)
		Output operation		Incorporated with 2 outputs: Light-ON/Dark-ON
		Short-circuit protection	Incorporated	
Response time		Under light received condition: 20 μs or less Under light interrupted condition: 80 μs or less (Maximum response frequency: 3 kHz) (Note 2)		
Operation indicator		Orange LED (lights up under light received condition)		
Pollution degree		3		
Environmental resistance	Protection	IP64 (IEC)		
	Ambient temperature	-25 to +55 °C -13 to +131 °F (No dew condensation or icing allowed), Storage: -30 to +80 °C -22 to +176 °F		
	Ambient humidity	5 to 85 % RH, Storage: 5 to 95 % RH		
	Ambient illuminance	Fluorescent light: 1,000 lx or less at the light-receiving face		
	Voltage withstandability	1,000 V AC for one min. between all supply terminals connected together and enclosure		
	Insulation resistance	20 MΩ, or more, with 250 V DC megger between all supply terminals connected together and enclosure		
	Vibration resistance	10 to 2,000 Hz frequency, 1.5 mm 0.059 in double amplitude (maximum acceleration 196 m/s ²) in X, Y and Z directions for two hours each		
Shock resistance	15,000 m/s ² acceleration (1,500 G approx.) in X, Y and Z directions three times each			
Emitting element		Infrared LED (Peak emission wavelength: 855 nm 0.034 mil , non-modulated)		
Material		Enclosure: PBT, Display section: Polycarbonate		
Cable		0.09 mm ² 4-core cabtyre cable, PVC, 1 m 3.281 ft long	0.09 mm ² 4-core cabtyre cable, PVC, 3 m 9.843 ft long	
Cable extension		Extension up to total 100 m 328.084 ft is possible with 0.3 mm ² , or more, cable. (Note 3)		
Weight		Net weight: 10 g approx., Gross weight: 15 g approx.	Net weight: 30 g approx., Gross weight: 35 g approx.	

Notes: 1) Where measurement conditions have not been specified precisely, the conditions used were an ambient temperature of +23 °C **+73.4 °F**.
2) The response frequency is the value when the disc, given in the figure below, is rotated.

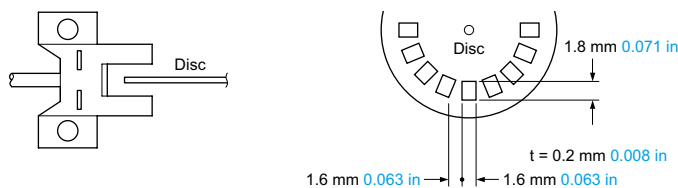

3) If the cable is extended to 20 m **65.617 ft** or longer, confirm that the supply voltage at the end of the cable attached to the sensor is 4.5 V or higher.

FIBER SENSORS
LASER SENSORS
PHOTO-ELECTRIC SENSORS
MICRO PHOTO-ELECTRIC SENSORS
AREA SENSORS
SAFETY LIGHT CURTAINS / SAFETY COMPONENTS
PRESSURE / FLOW SENSORS
INDUCTIVE PROXIMITY SENSORS
PARTICULAR USE SENSORS
SENSOR OPTIONS
SIMPLE WIRE-SAVING UNITS
WIRE-SAVING SYSTEMS
MEASURE-MENT SENSORS
STATIC CONTROL DEVICES
LASER MARKERS
PLC
HUMAN MACHINE INTERFACES
ENERGY MANAGEMENT SOLUTIONS
FA COMPONENTS
MACHINE VISION SYSTEMS
UV CURING SYSTEMS
Selection Guide
U-shaped
Convergent Reflective
PM-25/PM-45/PM-65

- FIBER SENSORS
- LASER SENSORS
- PHOTO-ELECTRIC SENSORS
- MICRO PHOTO-ELECTRIC SENSORS
- AREA SENSORS
- SAFETY LIGHT CURTAINS / SAFETY COMPONENTS
- PRESSURE / FLOW SENSORS
- INDUCTIVE PROXIMITY SENSORS
- PARTICULAR USE SENSORS
- SENSOR OPTIONS
- SIMPLE WIRE-SAVING UNITS
- WIRE-SAVING SYSTEMS
- MEASUREMENT SENSORS
- STATIC CONTROL DEVICES
- LASER MARKERS
- PLC
- HUMAN MACHINE INTERFACES
- ENERGY MANAGEMENT SOLUTIONS
- FA COMPONENTS
- MACHINE VISION SYSTEMS
- UV CURING SYSTEMS
- Selection Guide
- U-shaped
- Convergent Reflective
- PM-25/PM-45/PM-65

Compact / Connector built-in type PM-65 SERIES

Easy connection with a single touch using commercially-available connectors

Cable type	NPN output	Connector attached cable 1 m 1.236 in, 2 m 0.787 in, 3 m 0.914 in, 5 m 1.575 in	Connector attached bending-resistant cable 1 m 1.236 in, 2 m 0.787 in, 3 m 0.914 in, 5 m 1.575 in
	PNP output	Connector attached cable 1 m 1.236 in, 2 m 0.787 in, 3 m 0.914 in, 5 m 1.575 in	Connector attached bending-resistant cable 1 m 1.236 in, 2 m 0.787 in, 3 m 0.914 in, 5 m 1.575 in



* NPN output type only



ORDER GUIDE

Type	Appearance (mm in)	Sensing range	Model No.	Output	Output operation	
Compact / Connector built-in type	 26 1.024, 22.4 0.882, 7 0.276	6 mm 0.236 in (fixed)	PM-K65	NPN open-collector transistor	Incorporated with 2 outputs: Light-ON/Dark-ON	
			PM-K65-P	PNP open-collector transistor		
	 26 1.024, 22.4 0.882, 13.7 0.539		PM-T65	NPN open-collector transistor		
			PM-T65-P	PNP open-collector transistor		
			 22.4 0.882, 16.7 0.657	PM-T65W		NPN open-collector transistor
				PM-T65W-P		PNP open-collector transistor
	 26.2 1.031, 15.7 0.618, 14.9 0.587		PM-L65	NPN open-collector transistor		
			PM-L65-P	PNP open-collector transistor		
	 13.4 0.528, 22.7 0.894, 14.9 0.587		PM-Y65	NPN open-collector transistor		
			PM-Y65-P	PNP open-collector transistor		
	 13.5 0.531, 13.4 0.528, 22.4 0.882		PM-F65	NPN open-collector transistor		
			PM-F65-P	PNP open-collector transistor		
			 13 0.512, 13.4 0.528, 22.4 0.882	PM-F65W		NPN open-collector transistor
				PM-F65W-P		PNP open-collector transistor
			 13.5 0.531, 13.4 0.528, 22.4 0.882	PM-R65		NPN open-collector transistor
				PM-R65-P		PNP open-collector transistor
	 13 0.512, 13.4 0.528, 22.4 0.882			PM-R65W		NPN open-collector transistor
				PM-R65W-P		PNP open-collector transistor

Note: **PM-T65W** is mounting-compatible with our conventional model "PM-T64W".
PM-F65W(-P) is mounting-compatible with our conventional model "PM-F54(P)".
PM-R65W(-P) is mounting-compatible with our conventional model "PM-R54(P)".

OPTIONS

Designation	Model No.	Description	
Connector attached cable	CN-14A-C1	Length: 1m 3.281 ft	0.2 mm ² 4-core cabtyre cable with connector on one end Cable outer diameter: \varnothing 3.7 mm \varnothing0.146 in
	CN-14A-C2	Length: 2m 6.562 ft	
	CN-14A-C3	Length: 3m 9.843 ft	
	CN-14A-C5	Length: 5m 16.404 ft	
Connector attached cable (Bending-resistant)	CN-14A-R-C1	Length: 1m 3.281 ft	0.2 mm ² 4-core cabtyre cable with connector on one end Cable outer diameter: \varnothing 3.7 mm \varnothing0.146 in
	CN-14A-R-C2	Length: 2m 6.562 ft	
	CN-14A-R-C3	Length: 3m 9.843 ft	
	CN-14A-R-C5	Length: 5m 16.404 ft	
Connector	CN-14A	Set of 10 housings and 40 contacts	

Connector attached cable

- **CN-14A(-R)-C□**

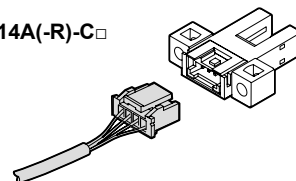

Connector

- **CN-14A**

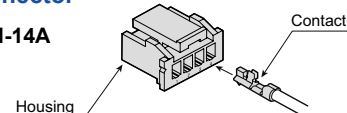

SPECIFICATIONS

Item	Model No.	Type	Compact / Connector built-in type	
				Mounting-compatible with conventional model (Note 2)
		NPN output	PM-□65	PM-□65W
		PNP output	PM-□65-P	PM-□65W-P
CE marking directive compliance	EMC Directive, RoHS Directive			
Sensing range	6 mm 0.236 in (fixed)			
Minimum sensing object	0.8 × 1.2 mm 0.031 × 0.047 in opaque object			
Hysteresis	0.05 mm 0.002 in or less			
Repeatability	0.01 mm 0.0004 in or less			
Supply voltage	5 to 24 V DC \pm 10 % Ripple P-P 10 % or less			
Current consumption	15 mA or less			
Output	<NPN output type> NPN open-collector transistor		<PNP output type> PNP open-collector transistor	
	<ul style="list-style-type: none"> • Maximum sink current: 50 mA • Applied voltage: 30 V DC or less (between output and 0 V) • Residual voltage: 2 V or less (at 50 mA sink current) 1 V or less (at 16 mA sink current) 		<ul style="list-style-type: none"> • Maximum source current: 50 mA • Applied voltage: 30 V DC or less (between output and +V) • Residual voltage: 2 V or less (at 50 mA source current) 1 V or less (at 16 mA source current) 	
	Output operation	Incorporated with 2 outputs: Light-ON/Dark-ON		
	Short-circuit protection	Incorporated		
Response time	Under light received condition: 20 μ s or less, Under light interrupted condition: 80 μ s or less (Maximum response frequency: 3 kHz) (Note 3)			
Operation indicator	Orange LED (lights up under light received condition)			
Pollution degree	3			
Environmental resistance	Protection	IP40 (IEC)		
	Ambient temperature	-25 to +55 °C -13 to +131 °F (No dew condensation or icing allowed), Storage: -30 to +80 °C -22 to +176 °F		
	Ambient humidity	5 to 85 % RH, Storage: 5 to 95 % RH		
	Ambient illuminance	Fluorescent light: 1,000 lx or less at the light-receiving face		
	Voltage withstandability	1,000 V AC for one min. between all supply terminals connected together and enclosure		
	Insulation resistance	20 M Ω , or more, with 250 V DC megger between all supply terminals connected together and enclosure		
	Vibration resistance	10 to 2,000 Hz frequency, 1.5 mm 0.059 in double amplitude (maximum acceleration 196 m/s ²) in X, Y and Z directions for two hours each		
Shock resistance	15,000 m/s ² acceleration (1,500 G approx.) in X, Y and Z directions three times each			
Emitting element	Infrared LED (Peak emission wavelength: 855 nm 0.034 mil , non-modulated)			
Material	Enclosure: PBT, Display section: Polycarbonate			
Cable length	Extension up to total 100 m 328.084 ft is possible with 0.3 mm ² , or more, cable. (Note 4)			
Weight	Net weight: 3 g approx., Gross weight: 3 g approx.			

- Notes: 1) Where measurement conditions have not been specified precisely, the conditions used were an ambient temperature of +23 °C **+73.4 °F**.
 2) **PM-T65W** is mounting-compatible with our conventional model "**PM-T64W**".
PM-F65W(-P) is mounting-compatible with our conventional model "**PM-F54(P)**".
PM-R65W(-P) is mounting-compatible with our conventional model "**PM-R54(P)**".
 3) The response frequency is the value when the disc, given in the figure below, is rotated.

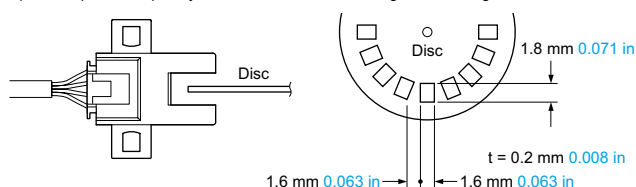

- 4) If the cable is extended to 20 m **65.617 ft** or longer, confirm that the supply voltage at the end of the cable attached to the sensor is 4.5 V or higher.

Recommended connector

Contact: SPHD-001T-P0.5, Housing: PAP-04V-S
(Manufactured by J.S.T. Mfg. Co., Ltd.)

Note: Contact the manufacturer for details of the recommended products.

Recommended crimping tool

Model No. : YC-610R (Manufactured by J.S.T. Mfg. Co., Ltd.)

Note: Contact the manufacturer for details of the recommended products.

FIBER SENSORS

LASER SENSORS

PHOTO-ELECTRIC SENSORS

MICRO PHOTO-ELECTRIC SENSORS

AREA SENSORS

SAFETY LIGHT CURTAINS / SAFETY COMPONENTS

PRESSURE / FLOW SENSORS

INDUCTIVE PROXIMITY SENSORS

PARTICULAR USE SENSORS

SENSOR OPTIONS

SIMPLE WIRE-SAVING UNITS

WIRE-SAVING SYSTEMS

MEASUREMENT SENSORS

STATIC CONTROL DEVICES

LASER MARKERS

PLC

HUMAN MACHINE INTERFACES

ENERGY MANAGEMENT SOLUTIONS

FA COMPONENTS

MACHINE VISION SYSTEMS

UV CURING SYSTEMS

Selection Guide

U-shaped

Convergent Reflective

PM-25/PM-45/PM-65

FIBER SENSORS
 LASER SENSORS
 PHOTO-ELECTRIC SENSORS
 MICRO PHOTO-ELECTRIC SENSORS
 AREA SENSORS
 SAFETY LIGHT CURTAINS / SAFETY COMPONENTS
 PRESSURE / FLOW SENSORS
 INDUCTIVE PROXIMITY SENSORS
 PARTICULAR USE SENSORS
 SENSOR OPTIONS
 SIMPLE WIRE-SAVING UNITS
 WIRE-SAVING SYSTEMS
 MEASUREMENT SENSORS
 STATIC CONTROL DEVICES
 LASER MARKERS
 PLC
 HUMAN MACHINE INTERFACES
 ENERGY MANAGEMENT SOLUTIONS
 FA COMPONENTS
 MACHINE VISION SYSTEMS
 UV CURING SYSTEMS
 Selection Guide
 U-shaped
 Convergent Reflective
 PM-25/PM-45/PM-65

I/O CIRCUIT AND WIRING DIAGRAMS

NPN output type

I/O circuit diagram

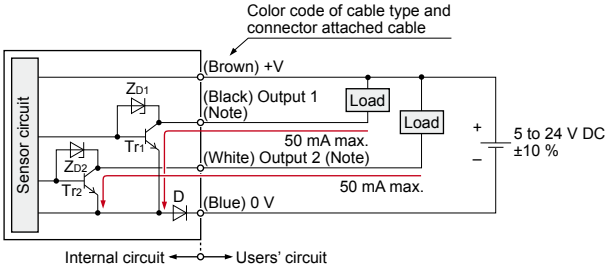

Note: Ensure to insulate the unused output wire.

Symbols...D: Reverse supply polarity protection diode
 ZD1, ZD2: Surge absorption zener diode
 Tr1, Tr2: NPN output transistor

Wiring diagram (PM-25 series / PM-45 series)

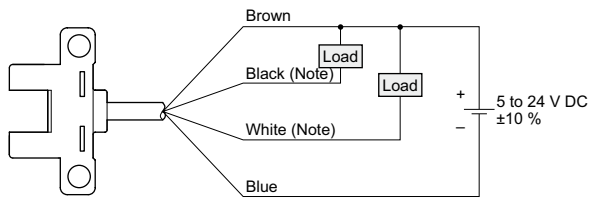

Note: Ensure to insulate the unused output wire.

Output operation

	Color code	Output operation
Output 1	Black	Light-ON
Output 2	White	Dark-ON

Terminal arrangement diagram (PM-65 series)

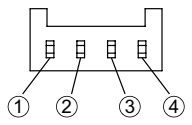

Terminal No.	Designation
①	+V
②	Output 1: Light-ON
③	Output 2: Dark-ON
④	0 V

PNP output type

I/O circuit diagram

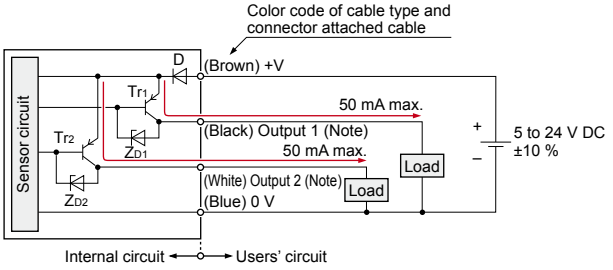

Note: Ensure to insulate the unused output wire.

Symbols...D: Reverse supply polarity protection diode
 ZD1, ZD2: Surge absorption zener diode
 Tr1, Tr2: PNP output transistor

Wiring diagram (PM-25 series / PM-45 series)

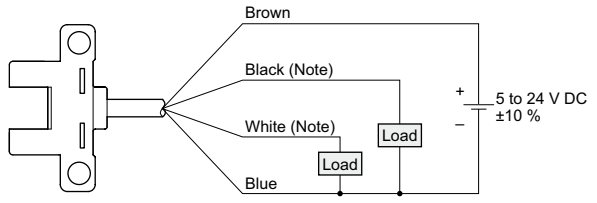

Note: Ensure to insulate the unused output wire.

Output operation

	Color code	Output operation
Output 1	Black	Light-ON
Output 2	White	Dark-ON

Terminal arrangement diagram (PM-65 series)

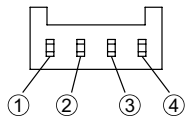

Terminal No.	Designation
①	+V
②	Output 1: Light-ON
③	Output 2: Dark-ON
④	0 V

SENSING CHARACTERISTICS (TYPICAL)

PM-25 series

Sensing position

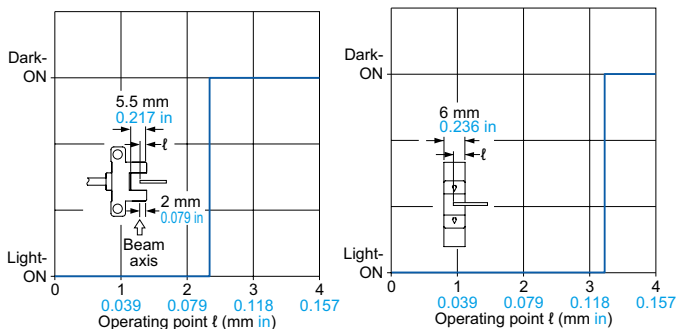

PM-65 series

Sensing position

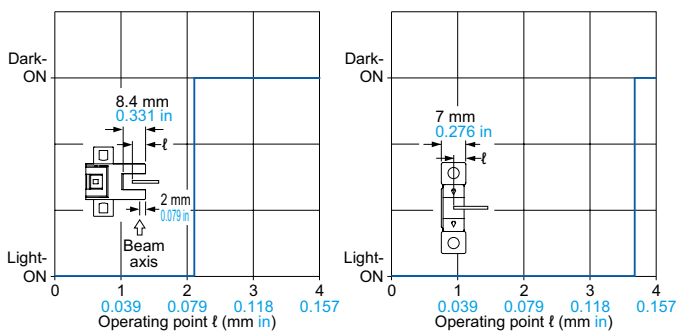

PM-45 series

Sensing position

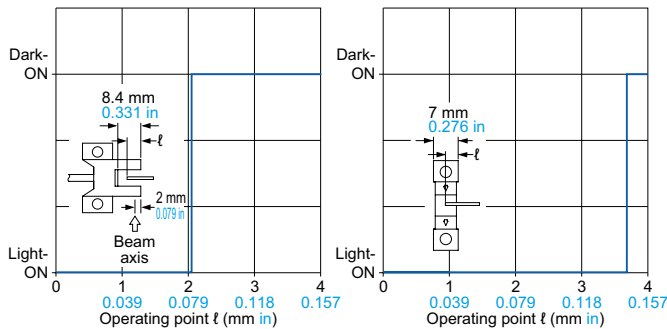

PRECAUTIONS FOR PROPER USE

Refer to p.1552~ for general precautions.



- Never use this product as a sensing device for personnel protection.
- In case of using sensing devices for personnel protection, use products which meet laws and standards, such as OSHA, ANSI or IEC etc., for personnel protection applicable in each region or country.

Mounting

PM-25 series

- The following conditions must be observed when using screws to mount the sensor unit.

Screw	Spring washer	Flat washer	Tightening torque
M2 screw	1 pc.	ø4.3 mm ø0.169 in (small round washer)	0.15 N·m
M3 screw	1 pc.	ø6 mm ø0.236 in (small round washer)	0.5 N·m

< When using M2 screws for mounting > < When using M3 screws for mounting >

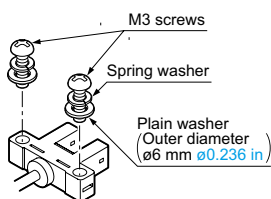
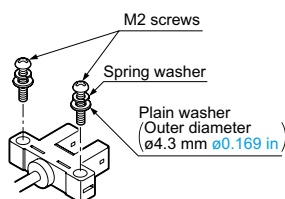

When using the optional mounting screw set **MS-M2**, a spring washer is included.

- In case the **PM-25** series is used at an ambient temperature of +50 °C +122 °F, or more, make sure to mount it on a metal body.

PM-45 series

- The following conditions must be observed when using screws to mount the sensor unit.

Screw	Spring washer	Flat washer	Tightening torque
M3 screw	1 pc.	ø6 mm ø0.236 in (small round washer)	0.5 N·m

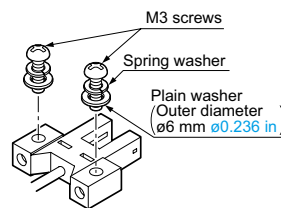

PM-65 series

- The following conditions must be observed when using screws to mount the sensor unit.

Screw	Spring washer	Flat washer	Tightening torque
M3 screw	1 pc.	ø6 mm ø0.236 in (small round washer)	0.5 N·m

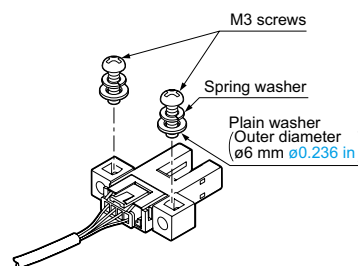

FIBER SENSORS

LASER SENSORS

PHOTO-ELECTRIC SENSORS

MICRO PHOTO-ELECTRIC SENSORS

AREA SENSORS

SAFETY LIGHT CURTAINS / SAFETY COMPONENTS

PRESSURE / FLOW SENSORS

INDUCTIVE PROXIMITY SENSORS

PARTICULAR USE SENSORS

SENSOR OPTIONS

SIMPLE WIRE-SAVING UNITS

WIRE-SAVING SYSTEMS

MEASUREMENT SENSORS

STATIC CONTROL DEVICES

LASER MARKERS

PLC

HUMAN MACHINE INTERFACES

ENERGY MANAGEMENT SOLUTIONS

FA COMPONENTS

MACHINE VISION SYSTEMS

UV CURING SYSTEMS

Selection Guide

U-shaped

Convergent Reflective

PM-25/PM-45/PM-65

PRECAUTIONS FOR PROPER USE

Refer to p.1552~ for general precautions.

Cable extension

PM-25 series / PM-45 series

- Cable extension is possible up to an overall length of 100 m **328.084 ft** with a 0.3 mm², or more, cable. However, since a voltage drop shall occur due to the cable extension, ensure that the power supply voltage at the end of the cable attached to the sensor is within the rating.

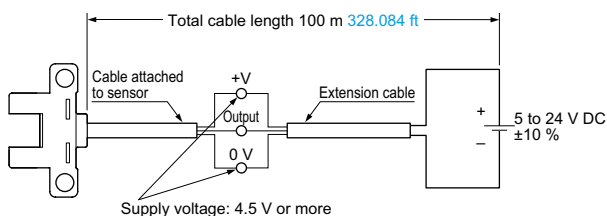

But, when the overall cable length, including the cable attached to the sensor, is as given below, there is no need to confirm the voltage.

Conductor cross-section area of extension cable	Total cable length
0.08 to 0.1 mm ²	Up to 5 m 16.404 ft
0.2 mm ²	Up to 10 m 32.808 ft
0.3 mm ²	Up to 20 m 65.617 ft

PM-65 series

- Cable extension is possible up to an overall length of 100 m **328.084 ft** with a 0.3 mm², or more, cable. However, since a voltage drop shall occur due to the cable extension, ensure that the power supply voltage at the end of the connector attached cable of the sensor or at the sensor terminals is within the rating.

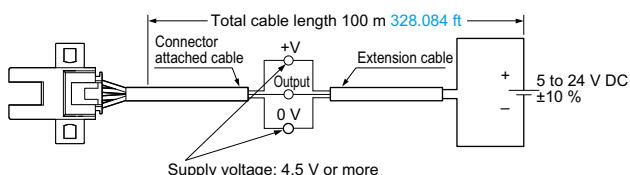

But, when the overall cable length, including the cable attached to the sensor, is as given below, there is no need to confirm the voltage.

Conductor cross-section area of extension cable	Total cable length
0.08 to 0.1 mm ²	Up to 5 m 16.404 ft
0.2 mm ²	Up to 10 m 32.808 ft
0.3 mm ²	Up to 20 m 65.617 ft

Wiring (PM-65 series)

Connection method

- Insert the connector attached cable **CN-14A-C** / **CN-14A-R-C** in the connector part of this product as shown in the figure below.

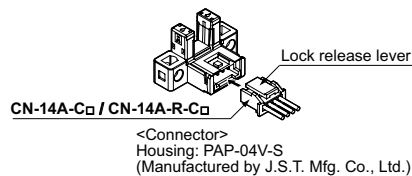

<Connector pin position>

Connector pin No.	①	②	③	④
Terminal designation	+V	Output 1	Output 2	0 V

Disconnection method

- Press and hold the lock release lever to disconnect the cable connector.

Note: Pulling the cable without pressing the lock release lever in an attempt to disconnect the connector can cause wire breakage in the cable or damage to the connector.

When using the product as an S-mark compatible product in Korea

- The power supply cable and output cable connected to the product must be less than 10 m **32.808 ft**.

Others

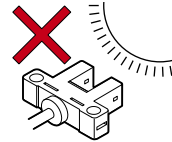
- This device has been developed / produced for industrial use only.
- Since the sensor is intended for use inside machines, no special countermeasures have been taken against extraneous light. Take care that extraneous light is not directly incident on the beam receiving section. 
- Do not use during the initial transient time (50 ms) after the power supply is switched on.
- Note that the cable of **PM-□25-R** loses its flexibility when the ambient temperature decreases to about -10 °C **+14 °F**.
- The cable of **PM-□25-R** is a bending-resistant cable usable on a moving base. When the sensor is mounted on a moving base, secure the sensor cable joint at the unit in place so that stress is not applied to it.
- When storing **PM-□25-R**, make sure that the cable does not come into contact with the sensing section or operation indicator.
- If the sensor is used in a place having excessive dust, periodically clean the emitting and receiving sections with a dry, soft cloth.
- If there is a large surge generating equipment, such as, motor, solenoid, electromagnetic valve, etc., in the vicinity of the sensor, use a surge absorber on that equipment. Further, do not run the sensor cables along power lines and use a capacitor between +V and 0 V, if required. Use the sensor after confirming that the surge has been eliminated.

DIMENSIONS (Unit: mm in)

The CAD data can be downloaded from our website.

PM-K25□ Sensor

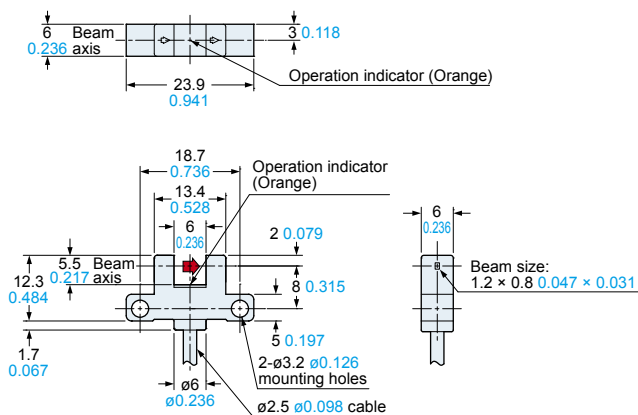

PM-L25□ Sensor

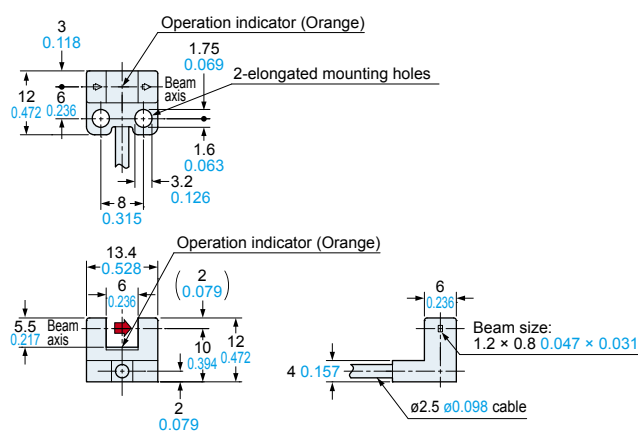

PM-U25□ Sensor

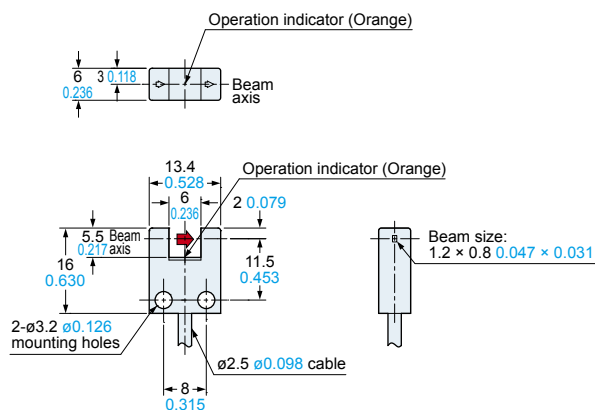

PM-F25□ Sensor

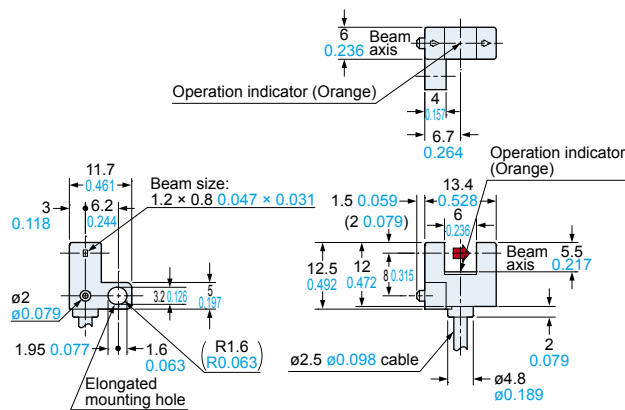

PM-R25□ Sensor

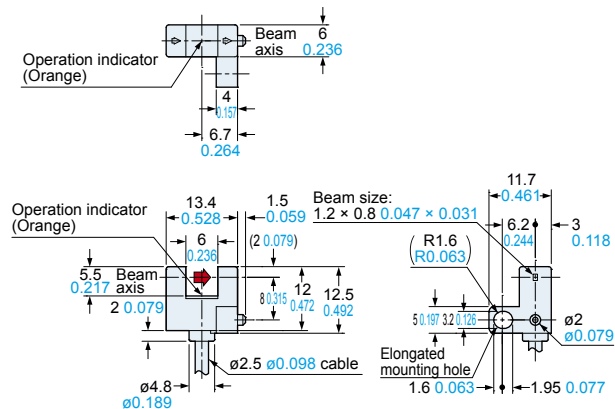

FIBER SENSORS

LASER SENSORS

PHOTO-ELECTRIC SENSORS

MICRO PHOTO-ELECTRIC SENSORS

AREA SENSORS

SAFETY LIGHT CURTAINS / SAFETY COMPONENTS

PRESSURE / FLOW SENSORS

INDUCTIVE PROXIMITY SENSORS

PARTICULAR USE SENSORS

SENSOR OPTIONS

SIMPLE WIRE-SAVING UNITS

WIRE-SAVING SYSTEMS

MEASURE-MENT SENSORS

STATIC CONTROL DEVICES

LASER MARKERS

PLC

HUMAN MACHINE INTERFACES

ENERGY MANAGEMENT SOLUTIONS

FA COMPONENTS

MACHINE VISION SYSTEMS

UV CURING SYSTEMS

Selection Guide

U-shaped

Convergent Reflective

PM-25/PM-45/PM-65

DIMENSIONS (Unit: mm in)

The CAD data can be downloaded from our website.

- FIBER SENSORS
- LASER SENSORS
- PHOTO-ELECTRIC SENSORS
- MICRO PHOTO-ELECTRIC SENSORS
- AREA SENSORS
- SAFETY LIGHT CURTAINS / SAFETY COMPONENTS
- PRESSURE / FLOW SENSORS
- INDUCTIVE PROXIMITY SENSORS
- PARTICULAR USE SENSORS
- SENSOR OPTIONS
- SIMPLE WIRE-SAVING UNITS
- WIRE-SAVING SYSTEMS
- MEASUREMENT SENSORS
- STATIC CONTROL DEVICES
- LASER MARKERS
- PLC
- HUMAN MACHINE INTERFACES
- ENERGY MANAGEMENT SOLUTIONS
- FA COMPONENTS
- MACHINE VISION SYSTEMS
- UV CURING SYSTEMS

PM-K45□ Sensor

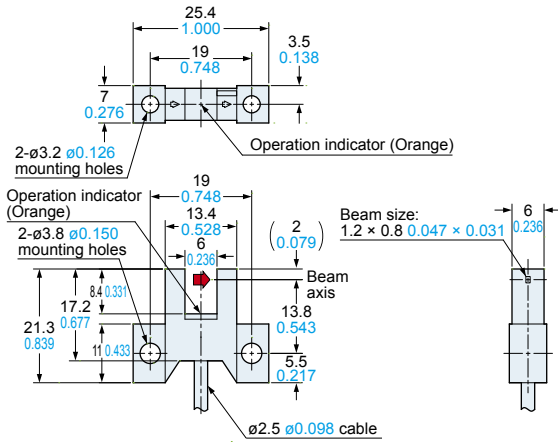

PM-T45□ Sensor

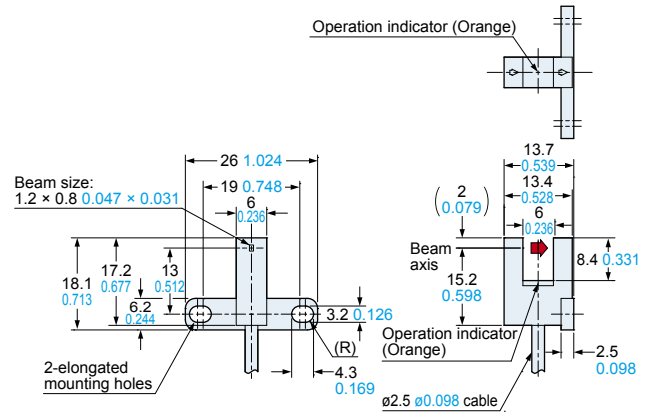

PM-L45□ Sensor

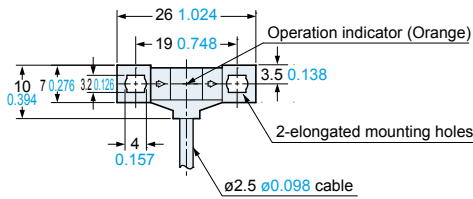

PM-Y45□ Sensor

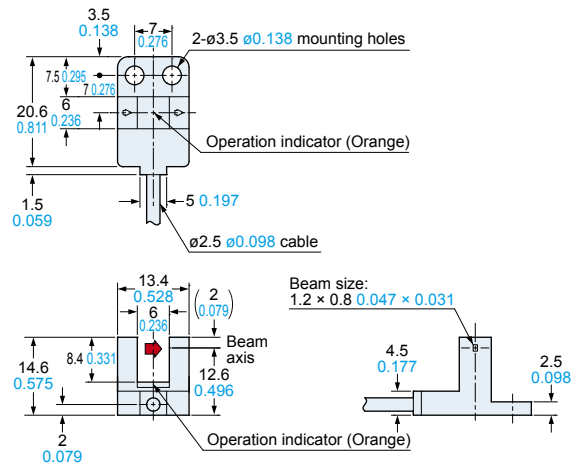

PM-F45□ Sensor

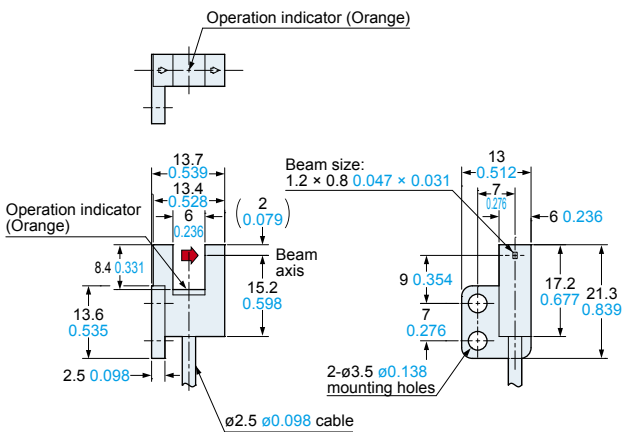

PM-R45□ Sensor

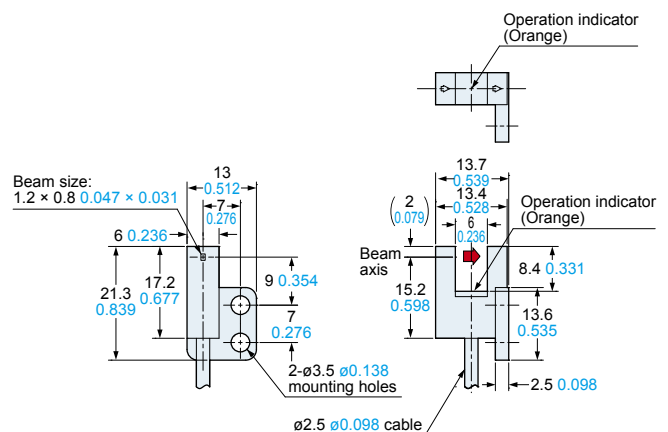

- Selection Guide
- U-shaped
- Convergent Reflective
- PM-25/PM-45/PM-65

DIMENSIONS (Unit: mm in)

The CAD data can be downloaded from our website.

PM-K65 PM-K65-P Sensor

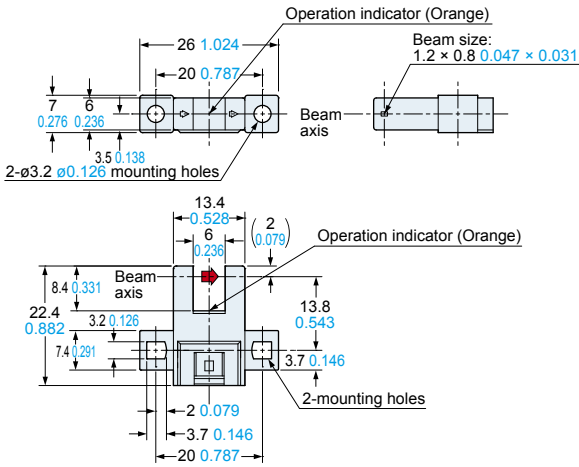

PM-T65 PM-T65-P Sensor

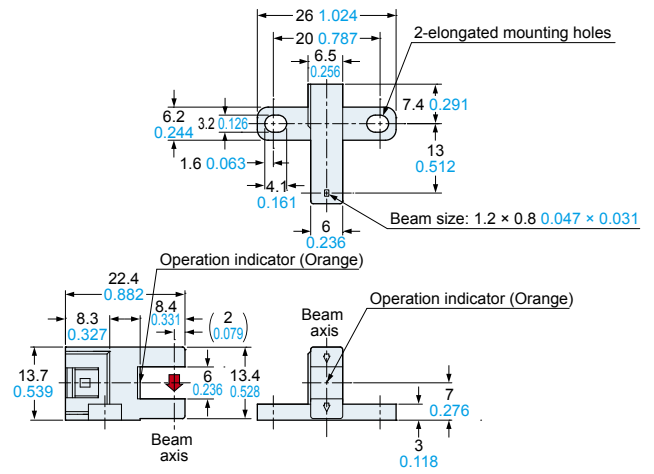

PM-T65W PM-T65W-P Sensor

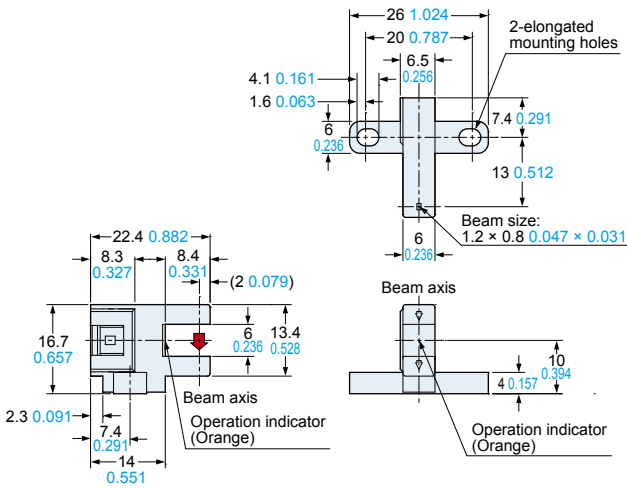

PM-L65 PM-L65-P Sensor

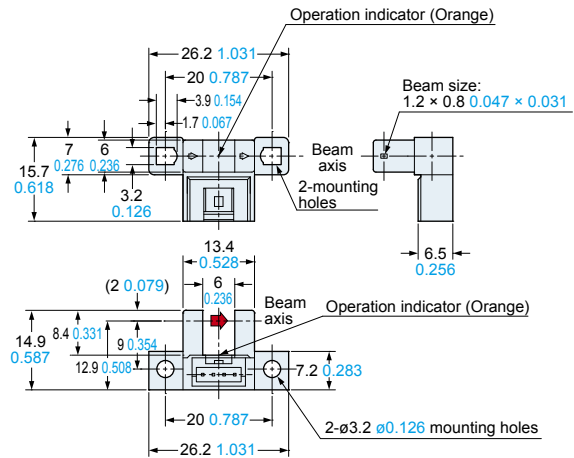

PM-Y65 PM-Y65-P Sensor

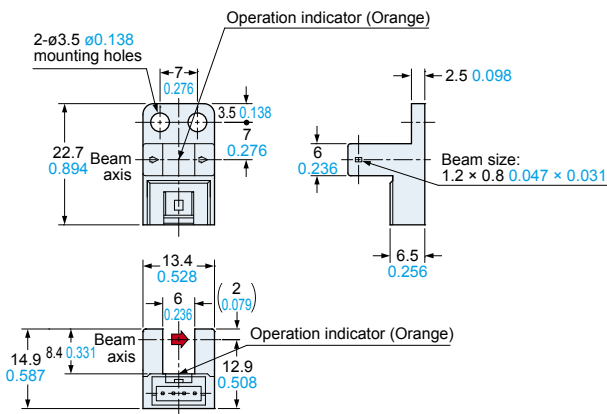

PM-F65 PM-F65-P Sensor

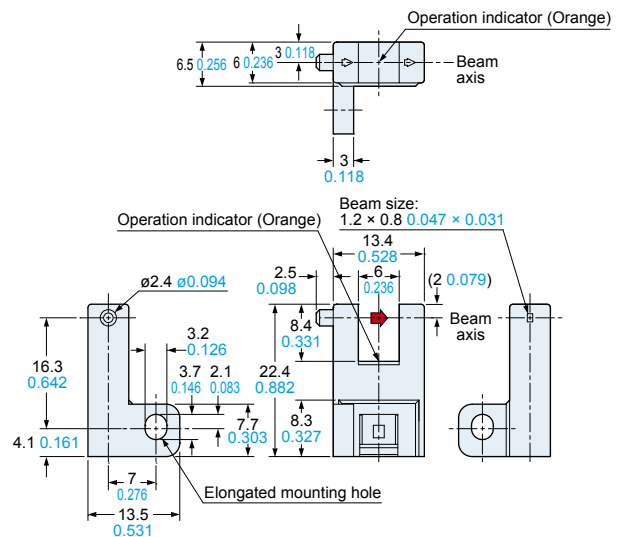

FIBER SENSORS

LASER SENSORS

PHOTO-ELECTRIC SENSORS

MICRO PHOTO-ELECTRIC SENSORS

AREA SENSORS

SAFETY LIGHT CURTAINS / SAFETY COMPONENTS

PRESSURE / FLOW SENSORS

INDUCTIVE PROXIMITY SENSORS

PARTICULAR USE SENSORS

SENSOR OPTIONS

SMILE WIRE-SAVING UNITS

WIRE-SAVING SYSTEMS

MEASUREMENT SENSORS

STATIC CONTROL DEVICES

LASER MARKERS

PLC

HUMAN MACHINE INTERFACES

ENERGY MANAGEMENT SOLUTIONS

FA COMPONENTS

MACHINE VISION SYSTEMS

UV CURING SYSTEMS

Selection Guide

U-shaped

Convergent Reflective

PM-25/PM-45/PM-65

DIMENSIONS (Unit: mm in)

The CAD data can be downloaded from our website.

- FIBER SENSORS
- LASER SENSORS
- PHOTO-ELECTRIC SENSORS
- MICRO PHOTO-ELECTRIC SENSORS
- AREA SENSORS
- SAFETY LIGHT CURTAINS / SAFETY COMPONENTS
- PRESSURE / FLOW SENSORS
- INDUCTIVE PROXIMITY SENSORS
- PARTICULAR USE SENSORS
- SENSOR OPTIONS
- SIMPLE WIRE-SAVING UNITS
- WIRE-SAVING SYSTEMS
- MEASURE-MENT SENSORS
- STATIC CONTROL DEVICES
- LASER MARKERS
- PLC
- HUMAN MACHINE INTERFACES
- ENERGY MANAGEMENT SOLUTIONS
- FA COMPONENTS
- MACHINE VISION SYSTEMS
- UV CURING SYSTEMS

PM-F65W PM-F65W-P Sensor

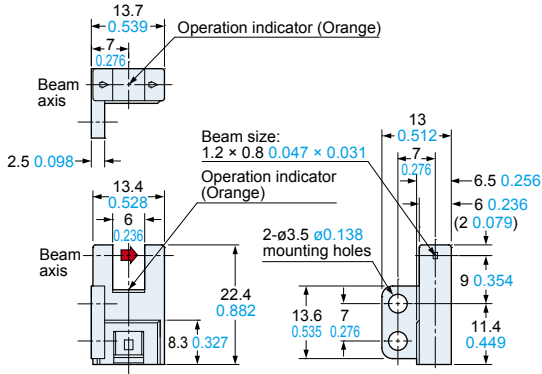

PM-R65 PM-R65-P Sensor

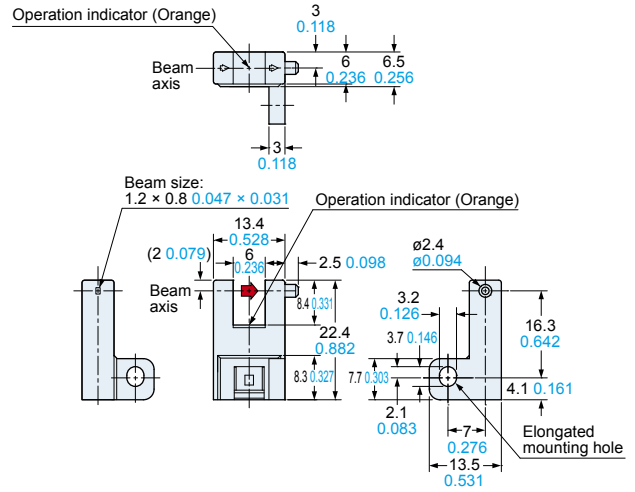

PM-R65W PM-R65W-P Sensor

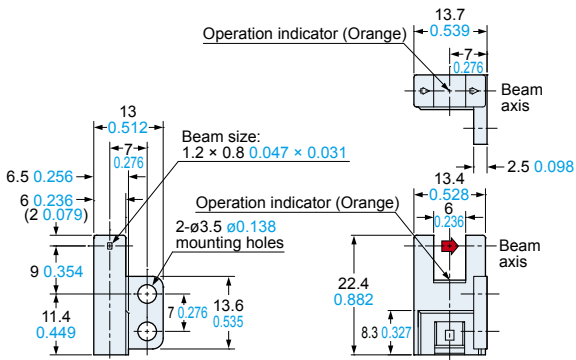

CN-14A-C□ CN-14A-R-C□ Connector attached cable (Optional)

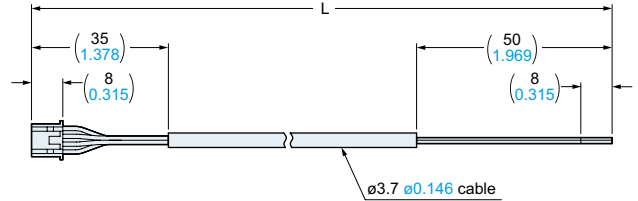

• Length L

Model No.	Length L
CN-14A(-R)-C1	1,000 39.370
CN-14A(-R)-C2	2,000 78.740
CN-14A(-R)-C3	3,000 118.110
CN-14A(-R)-C5	5,000 196.850

- Selection Guide
- U-shaped
- Convergent Reflective
- PM-25/PM-45/PM-65

MEMO

