

Catalogue

# Merlin Gerin

Miniature circuit-breakers and  
earth leakage circuit-breakers  
(MCBs/ELCBs)



# contents

---

	page
<b>Miniature circuit-breakers</b>	<b>C60a</b> 2
	<b>C60N</b> 3
	<b>C60H</b> 4
	<b>C60N UL489 - DC circuit breaker</b> 5
	<b>DC circuit breaker - application guide</b> 8
	<b>C120N</b> 9
	<b>C120H</b> 13
	<b>NC100L</b> 17
	<b>NC100LH</b> 19
	<b>electrical auxiliaries C60, C120</b> 21
	<b>electrical auxiliaries NC100</b> 22
<b>RCCB / ELCB</b>	<b>instantaneous RCCB/ELCB, selective RCCB/ELCB</b> 24
	<b>electrical auxiliaries RCCB/ELCB</b> 26
<b>Technical information</b>	<b>discrimination</b> 28
	<b>cascading</b> 30
	<b>dimensions</b> 31
<b>Mini pragma din kit</b>	<b>semi-equipped consumer unit</b> 32

---

# C60a Miniature circuit-breakers

B and C tripping curves

IEC 898: 4500, IEC 947-2: 5kA



23849

type	width in mod. of 9 mm	rat (A)	Cat No.	
			B curve	C curve
1P  1 protected pole	2	6	<b>23555</b>	<b>23849</b>
		10	<b>23556</b>	<b>23850</b>
		16	<b>23557</b>	<b>23851</b>
		20	<b>23559</b>	<b>23852</b>
		25	<b>23560</b>	<b>23853</b>
		32	<b>23561</b>	<b>23854</b>
		40	<b>23562</b>	<b>23855</b>



23863

type	width in mod. of 9 mm	rat (A)	Cat No.	
			B curve	C curve
2P  2 protected poles	4	6	<b>23571</b>	<b>23863</b>
		10	<b>23572</b>	<b>23864</b>
		16	<b>23573</b>	<b>23865</b>
		20	<b>23574</b>	<b>23866</b>
		25	<b>23575</b>	<b>23867</b>
		32	<b>23577</b>	<b>23868</b>
		40	<b>23578</b>	<b>23869</b>



23877

type	width in mod. of 9 mm	rat (A)	Cat No.	
			B curve	C curve
3P  3 protected poles	6	6	<b>23586</b>	<b>23877</b>
		10	<b>23587</b>	<b>23878</b>
		16	<b>23589</b>	<b>23880</b>
		20	<b>23590</b>	<b>23881</b>
		25	<b>23591</b>	<b>23882</b>
		32	<b>23592</b>	<b>23885</b>
		40	<b>23593</b>	<b>23886</b>

## B and C curves

### Application

control and protection of circuits against overloads and short-circuits.

- in domestic installation;
- in commercial and industrial electrical distribution systems.

### Technical data

- current rating: 6 to 40A;
- voltage rating: 230-400 V AC;
- breaking capacity:

□ I<sub>cn</sub> ultimate breaking capacity (O-CO cycle):

rat. (A)	type	voltage (V)	breaking capacity (A)
6 to 40	<b>1P</b>	230-240	4500
	<b>2, 3P</b>	400-415	4500

### to IEC 898

rat. (A)	type	voltage (V)	breaking capacity (A)
6 to 40	<b>1P</b>	230-240	4500
	<b>2, 3P</b>	400-415	4500

□ I<sub>cn</sub> = I<sub>cn</sub> = 4.5 kA,

□ I<sub>cn</sub> ultimate breaking capacity (O-CO cycle):

rat. (A)	type	voltage (V)	breaking capacity (A)
6 to 40	<b>1P</b>	130	10000
	<b>2, 3P</b>	230-240	5000

### to IEC 947-2

rat. (A)	type	voltage (V)	breaking capacity (A)
6 to 40	<b>1P</b>	130	10000
	<b>2, 3P</b>	230-240	5000
	<b>1P</b>	400-415	3000
	<b>2, 3P</b>	230-240	10000
	<b>2, 3P</b>	400-415	5000
	<b>2, 3P</b>	440	3000

- fast closing contacts;
- number of operating cycles (O-C); 20000;
- tripping characteristics:
- B curve: the magnetic releases operate between 3 and 5 I<sub>n</sub>;
- C curve: the magnetic releases operate between 5 and 10 I<sub>n</sub>;
- impulse withstand voltage (U<sub>imp</sub>): 6 kV;
- tropicalization: treatment 2 (relative humidity 95 % at 55 °C);
- weight (g):

type	1P	2P	3P
	110	220	340

■ connections: tunnel terminals for rigid

cables up to:

□ 25 mm<sup>2</sup> for rating ≤ 25A,

□ 35 mm<sup>2</sup> for rating 32 to 40 A;

■ installation: in all enclosures designed for Multi 9 equipment.

# C60N Miniature circuit-breakers

B, C and D tripping curves

IEC 898: 6000, IEC 947-2: 10kA



24395

type	width in mod. of 9 mm	rat (A)	Cat No.		
			B curve	C curve	D curve
1P  1 protected pole	2	1	24045	24395	24625
		2	24046	24396	24626
		3	24047	24397	24627
		4	24048	24398	24628
		6	24049	24399	24629
		10	24050	24401	24630
		16	24051	24403	24632
		20	24052	24404	24633
		25	24053	24405	24634
		32	24054	24406	24635
		40	24055	24407	24636
		50	24056	24408	24637
		63	24057	24409	24638



24331

type	width in mod. of 9 mm	rat (A)	Cat No.		
			B curve	C curve	D curve
2P  2 protected poles	4	1	24071	24331	24653
		2	24072	24332	24654
		3	24073	24333	24655
		4	24074	24334	24656
		6	24075	24335	24657
		10	24076	24336	24658
		16	24077	24337	24660
		20	24078	24338	24661
		25	24079	24339	24662
		32	24080	24340	24663
		40	24081	24341	24664
		50	24082	24342	24665
		63	24083	24343	24666



24344

type	width in mod. of 9 mm	rat (A)	Cat No.		
			B curve	C curve	D curve
3P  3 protected poles	6	1	24084	24344	24667
		2	24085	24345	24668
		3	24086	24346	24669
		4	24087	24347	24670
		6	24088	24348	24671
		10	24089	24349	24672
		16	24090	24350	24674
		20	24091	24351	24675
		25	24092	24352	24676
		32	24093	24353	24677
		40	24094	24354	24678
		50	24095	24355	24679
		63	24096	24356	24680



24357

type	width in mod. of 9 mm	rat (A)	Cat No.		
			B curve	C curve	D curve
4P  3 protected poles	8	1	24097	24357	24681
		2	24098	24358	24682
		3	24099	24359	24683
		4	24100	24360	24684
		6	24101	24361	24685
		10	24102	24362	24686
		16	24103	24363	24688
		20	24104	24364	24689
		25	24105	24365	24690
		32	24106	24366	24691
		40	24107	24367	24692
		50	24108	24368	24693
		63	24109	24369	24694

## B, C and D curves

### Application

control and protection of circuits against overloads and short-circuits.

- in domestic installation;
- in commercial and industrial electrical distribution systems;
- D curve: more particularly adapted for installations with high transient currents (LV/LV transformers, motors,...).

### Technical data

- current rating: 1 to 63 A;
- voltage rating: 230-400 V AC;
- breaking capacity:

□ Icn ultimate breaking capacity (O-CO cycle):

rat. (A)	type	voltage (V)	breaking capacity (A)
1 to 63	1P	230-240	6000
	2, 3, 4P	400-415	6000

#### to IEC 898

1 to 63	1P	230-240	6000
	2, 3, 4P	400-415	6000

□ Ics = Icn = 6 kA,

□ Icn ultimate breaking capacity (O-CO cycle):

rat. (A)	type	voltage (V)	breaking capacity (A)
1 to 63	1P	130	20000
		230-240	10000
		400-415	3000
2, 3, 4P		230-240	20000
		400-415	10000
		440	6000

#### to IEC 947-2

1 to 63	1P	130	20000
		230-240	10000
		400-415	3000
	2, 3, 4P	230-240	20000
		400-415	10000
		440	6000

- fast closing contacts;
- number of operating cycles (O-C): 20000;
- tripping characteristics:
- B curve: the magnetic releases operate between 3 and 5 In;
- C curve: the magnetic releases operate between 5 and 10 In;
- D curve: the magnetic releases operate between 10 and 14 In;
- impulse withstand voltage (U imp.): 6 kV;
- tropicalization: treatment 2 (relative humidity 95% at 55°C);
- weight (g):

type	1P	2P	3P	4P
	110	220	340	450

■ connections: tunnel terminals for rigid cables up to:

- 25 mm<sup>2</sup> for rating ≤ 25 A,
- 35 mm<sup>2</sup> for rating 32 to 63 A;

■ approvals: Marine, (consult us)

■ installation: in all enclosures designed for Multi 9 equipment.

# C60H Miniature circuit-breakers

B, C and D tripping curves

IEC 898: 10000, IEC 947-2: 15kA



24900

type	width in mod. of 9 mm	rat (A)			
		B curve	C curve	D curve	
1P 	2	0.5	24900	25171	
		0.75	24901		
		1	24968	25152	
		2	24969	25155	
		3	24970	25157	
		4	24971	25158	
		6	24643	24972	25159
		10	24644	24973	25160
		16	24646	24974	25161
		20	24647	24975	25164
		25	24648	24976	25165
		32	24649	24977	25166
		40	24650	24978	25167

1 protected pole



24902

type	width in mod. of 9 mm	rat (A)			
		B curve	C curve	D curve	
2P 	4	0.5	24902	25172	
		0.75	24903		
		1	24981	25183	
		2	24982	25184	
		3	24983	25185	
		4	24984	25186	
		6	24725	24985	25187
		10	24726	24986	25188
		16	24727	24987	25189
		20	24728	24988	25190
		25	24729	24989	25191
		32	24730	24990	25192
		40	24731	24991	25193

2 protected poles



24906

type	width in mod. of 9 mm	rat (A)			
		B curve	C curve	D curve	
3P 	6	0.5	24906	25173	
		0.75	24907		
		1	24994	25196	
		2	24995	25197	
		3	24996	25198	
		4	24997	25199	
		6	24738	24998	25200
		10	24739	24999	25201
		16	24740	25000	25202
		20	24741	25001	25203
		25	24742	25002	25205
		32	24743	25003	25207
		40	24744	25004	25208

3 protected poles

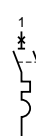

24908

type	width in mod. of 9 mm	rat (A)			
		B curve	C curve	D curve	
4P 	8	0.5	24908	25174	
		0.75	24909		
		1	25007	25211	
		2	25008	25212	
		3	25009	25213	
		4	25010	25214	
		6	24751	25011	25215
		10	24752	25012	25216
		16	24753	25013	25217
		20	24754	25014	25218
		25	24755	25015	25219
		32	24756	25016	25220
		40	24757	25017	25221

4 protected poles

## B, C and D curves

### Application

control and protection of circuits against overloads and short-circuits.

- in domestic installation;
- in commercial and industrial electrical distribution systems;
- D curve: more particularly adapted for installations with high transient currents (LV/LV transformers, motors,...).

### Technical data

- current rating: 0.5 to 63 A;
- voltage rating: 230-400 V AC;
- breaking capacity:

□ Icn ultimate breaking capacity (O-CO cycle):

rat. (A)	type	voltage (V)	breaking capacity (A)
to IEC 898	1 to 63	1P	230-240 1000
		2, 3, 4P	400-415 1000

to IEC 898

1 to 63	1P	230-240	1000
	2, 3, 4P	400-415	1000

□ Ics = 75% of Icn,

□ Icu ultimate breaking capacity (O-CO cycle):

rat. (A)	type	voltage (V)	breaking capacity (A)
to IEC 947-2	1 to 63	1P	130 30000
			240 15000

to IEC 947-2

1 to 63	1P	130	30000
		240	15000
		415	4000
	2, 3, 4P	240	30000
		415	15000
		440	10000

- positive contact indication;
- fast closing contacts;
- number of operating cycles (O-C): 20000;
- tripping characteristics:
- B curve: the magnetic releases operate between 3 and 5 In;
- C curve: the magnetic releases operate between 5 and 10 In;
- D curve: the magnetic releases operate between 10 and 14 In;
- impulse withstand voltage (U imp.): 6 kV;
- tropicalization: treatment 2 (relative humidity 95% at 55°C);

■ weight (g):

type	1P	2P	3P	4P
	110	220	340	450

■ connections: tunnel terminals for rigid cables up to:

- 25 mm<sup>2</sup> for rating ≤ 25 A,
- 35 mm<sup>2</sup> for rating 32 to 63 A;

■ approvals: Marine, (consult us)

■ installation: in all enclosures designed for Multi 9 equipment.

# C60 N UL 489

CSA 22.2 No 5.1

UL Listed   for branch circuit protection  
DC

## Main functions of C60N UL 489 circuit breaker:

- protection of circuits against:
  - short circuit currents
  - overload currents
- control
- isolation

## Various applications:

- semi-conductors
- electronic machinery
- control panel
- metal working
- telecommunication
- food, beverage
- packaging
- crane
- conveyors
- pumps and compressors
- HACR (Heating, Air conditioning, Refrigeration)
- engine generators

## Compliance with standards

- UL 489 circuit breakers File #E215117
- CSA C22.2 No. 5.1 circuit breakers File #179014
- IEC 60947-2, VDE 0660
- CE Marked

## Standard features

- Power circuit:
  - voltage rating: 120 up to 240 Vac Δ (delta)
  - ampere interrupting ratings:

rating (A) 77°F/25°C	number of poles	voltage (18 mm) 0.71 in.	interrupting rating (kA rms)	
			UL 489 / CSA	IEC 60947.2
0.5-35	1P		120 Vac	10
			240 Vac	5
	2P/3P		240 Vac	10
			415 Vac	-
	1P		440 Vac	-
			65 Vdc	10
2P		125 Vdc	10	

- fast closing: allows increased withstand of the high inrush currents of some loads
- current limiting
- trip-free mechanism: contacts cannot be held in the ON position when the circuit breaker is tripped automatically
- isolation with position break indication - Green strip on the circuit breaker operating handle indicates that all poles open
- number of operating cycles (0-C):
  - electrical: 10,000
  - mechanical: 20,000
- Environment:
  - tropicalization: treatment 2 (relative humidity: 95% at 131°F/55°C)
  - degree of protection:
    - case: IP40 as per IEC 60529
    - terminals: IP20
  - temperature:
    - operation: -22 to 158°F (-30 to 70°C)
    - storage: -40 to 176°F (-40 to 80°C)
- Weight (oz./g):

type	1P	2P	3P
C60N	3.88/110	7.75/220	11.64/330

## Connection

The C60N UL 489 is available in box lug/box lug connection



box lug/box lug

# C60 N UL 489

CSA 22.2 No 5.1

UL Listed   for branch circuit protection  
DC

---

### Connection characteristics

- Box lug UL 486A File #216919:
- 0.5-25 A: (#18-#4 AWG) 1-25mm<sup>2</sup> cables, torque 22 lb.in
- 30-35 A: (#18-#2 AWG) 1-35mm<sup>2</sup> cables, torque 31 lb.in



box lug

### Adaptable electrical auxiliaries

- Remote tripping:
  - shunt trip (MX + OF)
  - undervoltage release (MN)
- Remote indication:
  - auxiliary switch (OF)
  - alarm switch (SD)



### Time-current curves

**C curve** - Overcurrent protection for all application types:

- Ratings: 0.5-35 A set at 77°F (25°C)
  - Tripping curve: The magnetic releases operates between 7 and 10 times ampere rating
- D curve** - Overcurrent protection for loads with high inrush currents (motors, transformers etc.):
- Ratings: 0.5-35 A set at 77°F (25°C)
  - Tripping curve: The magnetic releases operates between 10 and 14 times ampere rating

# C60 N UL 489

CSA 22.2 No 5.1

UL Listed   for branch circuit protection  
DC

### Box lug / box lug connection (upstream / downstream)



058976N

type	width in modules 0.354 in. (9 mm)	rating (A)	reference C curve	D curve
1P	2	0.5	60100	60117
		1	60101	60118
		1.5	60102	60119
		2	60103	60120
		3	60104	60121
		4	60105	60122
		5	60106	60123
		6	60107	60124
		7	60108	60125
		8	60109	60126
		10	60110	60127
		13	60111	60128
		15	60112	60129
		20	60113	60130
		25	60114	60131
		30	60115	60132
		35	60116	60133
2P	4	0.5	60134	60151
		1	60135	60152
		1.5	60136	60153
		2	60137	60154
		3	60138	60155
		4	60139	60156
		5	60140	60157
		6	60141	60158
		7	60142	60159
		8	60143	60160
		10	60144	60161
		13	60145	60162
		15	60146	60163
		20	60147	60164
		25	60148	60165
		30	60149	60166
		35	60150	60167
3P	6	1	60168	60184
		1.5	60169	60185
		2	60170	60186
		3	60171	60187
		4	60172	60188
		5	60173	60189
		6	60174	60190
		7	60175	60191
		8	60176	60192
		10	60177	60193
		13	60178	60194
		15	60179	60195
		20	60180	60196
		25	60181	60197
		30	60182	60198
		35	60183	60199

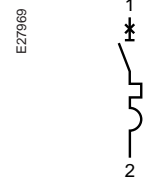

058977N

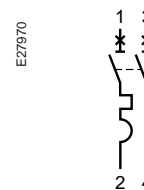

058978N

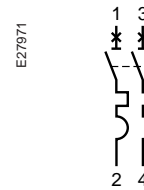



# DC circuit-breakers

## selecting the circuit breaker

The selection of type of circuit breaker most suitable for protection of a DC installation depends mainly of the following criteria:

- the rated current, which determines the rating of the equipment
- the type of system (1,2 or 3) (see below)

- the rated voltage, which determines the number of poles to be involved in breaking
- the maximum short-circuit current at the point of installation, which determines the breaking capacity

## calculation of the short-circuit current (ISC) at the terminals of a battery

When a short-circuit occurs at its terminals, a battery discharges a current given by ohm's law:

$$I_C = \frac{V_b}{R_i}$$

where  $V_b$  = the maximum discharge voltage (battery 100% charged) and  $R_i$  = the internal resistance equivalent to the sum of the cell resistances (figure generally given by the manufacturer in terms of Ampere-hour capacity of the battery).

### example

What is the short-circuit current at the terminals of standing battery with the following characteristics:

- capacity: 500 Ah
- maximum discharge voltage: 240V (110 cells of 2.2 V)
- discharge current: 300 A
- autonomy: 30 mm

- internal resistance: 0.5 mΩ per cell



$$R_i = 110 \times 0.5 \times 10^{-3}$$

$$I_C = \frac{240}{66 \times 10^{-3}} = 4.4 \text{ kA}$$

As the above calculation shows, the short-circuit current relatively weak.

Note: If the internal resistance is not known, the following approximate formula can be used:  $I_C = kC$ , where C is capacity of the battery expressed in Ampere-hours, and k is a coefficient close to 10 but in any case always lower than 20.

## arrangement of breaking poles according to the type of system

	system 1 the source has one polarity earthed	system 2 the source has a middle point earthed	system 3 the source is isolated from earth
<b>circuit diagrams and different kinds of fault</b>			
<b>analysis of each fault</b>	fault A: maximum ISC: only the positive polarity is involved fault B: maximum ISC: both polarities involved fault C: no consequences	ISC close to max. ISC: only the positive polarity is involved, at half voltage U/2 maximum ISC: both polarities involved as per fault A, but the polarity is involved	no consequences maximum ISC: both polarities involved no consequences
<b>the worst case</b>	fault A	fault A and C	fault B
<b>arrangement of breaking poles</b>	all poles needed for breaking are placed in series on the positive polarity (1), (2) <b>example:</b> U = 250 V, current I = 47 A. If a NC100LS is used, one pole is enough to break 250 V A single pole unit is therefore needed	number of poles necessary to break max. ISC at voltage U/2 should be placed on each polarity <b>example:</b> U = 250 V, current I = 100 A, ISC = 15 kA. Each pole will be subjected to a max. voltage U/2 = 125 V. With a NC100 (breaking cap. = 20 kA), 2 poles are involved in breaking a voltage of 125 V. A four pole NC100 is needed, with 2 poles in series in each polarity	number of poles necessary for breaking should be split between the two polarities <b>example:</b> U = 125 V, current I = 80 A. If a NC100 is used (breaking cap. = 20 kA) 2 poles are involved to break U = 125 V A two pole unit is needed, with one pole on each polarity
(1) or negative if the positive polarity earthed. (2) an extra pole will be needed on the earthed polarity to provide isolation	 to load	 to load	 to load

# C120N Miniature circuit-breakers

B, C and D curves

IEC 898: 10000 - IEC 947-2: 10 kA

## function

- protection of cables against overloads and short-circuits in final distribution
- manual control and isolation

- earth leakage protection when combined with a Vigi C120 module without temperature derating
- remote tripping, indication, by adding auxiliaries common to the entire C60/C120 range

## description

### Technical data

- current rating: 63 to 125 A
- voltage rating  $U_e$  max.: 440 V AC
- insulation voltage  $U_i$ : 500 V
- impulse withstand voltage  $U_{imp}$ : 6 kV
- compliance with standard IEC 898: devices accessible by inexperienced persons
- breaking capacity:
  - as in IEC 898

type	voltage (V)	breaking cap. $I_{cn}$ (A)
<b>1, 2, 3, 4P</b>	230...400	10000

- as in IEC 947-2 ( $I_{cu}$ )

type	voltage (V)	breaking cap. $I_{cu}$ (kA)
<b>1P</b>	130	20
	230...240	10
	400...415	3 (1)
<b>2, 3, 4P</b>	230...240	20
	400...415	10
	440	6

(1) breaking capacity under 1 pole with IT isolated neutral system (case of double fault)

- service breaking capacity  $I_{cs} = 75\% I_{cu}$
- positive break indication
- fast closing ensures simultaneous closing of poles
- electrical durability:
  - 63 A: 10000 cycles (O-C)
  - 80...125 A: 5000 cycles (O-C)
- limitation class: 3
- mechanical durability: 20000 cycles (O-C)
- bistable fixing pawl: simplifies disassembly
- weight (g):

1P	2P	3P	4P
205	410	615	820

- approval: IMQ
- connection:
  - flexible cables: 1.5 to 35 mm<sup>2</sup>
  - rigid cables: 1 to 50 mm<sup>2</sup>
  - terminals ensure:
    - degree of protection IP2
    - tightening of wide cross-section cables
    - pull-out withstand of cables
    - automatic guiding of cable into the correct position
- markers:
  - 4 marker clips next to the upstream terminal
  - label holder on handle (2P, 3P, 4P)
- degree of pollution: 3 (for use in an industrial environment)
- degree of protection:
  - open or surface mounted device: IP2
  - in a Pragma or Prisma enclosure: IP4 (IPxxD)

### B curve

- magnetic trip units operate between 3 and 5  $I_n$
- protection of very long cables
- protection of networks supplied by generators

### C curve

- magnetic trip units operate between 5 and 10  $I_n$
- protection of standard networks

### D curve

- magnetic trip units operate between 10 and 14  $I_n$
- protection of circuits that supply high inrush current loads: transformers, motors, etc.

# C120N Miniature circuit-breakers

B curve

IEC 898 : 10000 - IEC 947-2: 10 kA

## catalogue numbers



18340

type	rating (A)	catalogue number	width in mod. of 9 mm
------	------------	------------------	-----------------------

### B curve C120N

1P	63	<b>18340</b>	3
	80	<b>18341</b>	3
1	100	<b>18342</b>	3
*	125	<b>18343</b>	3



18344

2P	63	<b>18344</b>	6
	80	<b>18345</b>	6
1 3	100	<b>18346</b>	6
*	125	<b>18347</b>	6



18349

3P	63	<b>18348</b>	9
	80	<b>18349</b>	9
1 3 5	100	<b>18350</b>	9
*	125	<b>18351</b>	9



18355

4P	63	<b>18352</b>	12
	80	<b>18353</b>	12
1 3 5 7	100	<b>18354</b>	12
*	125	<b>18355</b>	12

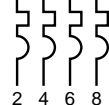

## additional information

electrical auxiliaries: page 21  
dimensions: page 31

# C120N Miniature circuit-breakers

C curve

IEC 898 : 10000 - IEC 947-2: 10 kA

## catalogue numbers



18356

type	rating (A)	catalogue number	width in mod. of 9 mm
------	------------	------------------	-----------------------

### C curve C120N

1P	63	<b>18356</b>	3
	80	<b>18357</b>	3
	100	<b>18358</b>	3
	125	<b>18359</b>	3



18360

2P	63	<b>18360</b>	6
	80	<b>18361</b>	6
	100	<b>18362</b>	6
	125	<b>18363</b>	6



18365

3P	63	<b>18364</b>	9
	80	<b>18365</b>	9
	100	<b>18367</b>	9
	125	<b>18369</b>	9



18377

4P	63	<b>18371</b>	12
	80	<b>18372</b>	12
	100	<b>18374</b>	12
	125	<b>18377</b>	12

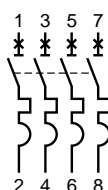

## additional information

electrical auxiliaries: page 21  
dimensions: page 31

# C120N Miniature circuit-breakers

D curve

IEC 898 : 10000 - IEC 947-2: 10 kA

## catalogue numbers



18378



18385



18389



18393

type	rating (A)	catalogue number	width in mod. of 9 mm
------	------------	------------------	-----------------------

### D curve C120N

1P 1 *  2	63	<b>18378</b>	3
	80	<b>18379</b>	3
	100	<b>18380</b>	3
	125	<b>18381</b>	3

2P 1 3 * *  2 4	63	<b>18382</b>	6
	80	<b>18383</b>	6
	100	<b>18384</b>	6
	125	<b>18385</b>	6

3P 1 3 5 * * *  2 4 6	63	<b>18386</b>	9
	80	<b>18387</b>	9
	100	<b>18388</b>	9
	125	<b>18389</b>	9

4P 1 3 5 7 * * * *  2 4 6 8	63	<b>18390</b>	12
	80	<b>18391</b>	12
	100	<b>18392</b>	12
	125	<b>18393</b>	12

## additional information

electrical auxiliaries: page 21  
dimensions: page 31

# C120H Miniature circuit-breakers

B, C and D curves

IEC 898 : 15000 - IEC 947-2: 15 kA

## function

- protection of cables against overloads and short-circuits in final distribution
- manual control and isolation

- earth leakage protection when combined with a Vigi C120 module without temperature derating
- remote tripping, indication, by adding auxiliaries common to the entire C60/C120 range

## description

### Technical data

- current rating: 10 to 125 A
- max. voltage rating  $U_e$ : 440 V AC
- insulation voltage  $U_i$ : 500 V
- impulse withstand voltage  $U_{imp}$ : 6 kV
- complies with standard IEC 898: devices accessible by unexperienced persons

### ■ breaking capacity:

- as in IEC 898

type	voltage (V)	breaking cap. $I_{cn}$ (A)
<b>1, 2, 3, 4P</b>	230...400	15000

- as in IEC 947-2 ( $I_{cu}$ )

type	voltage (V)	breaking cap. $I_{cu}$ (kA)
<b>1P</b>	130	30
	230...240	15
	400...415	4.5 (1)
<b>2, 3, 4P</b>	230...240	30
	400...415	15
	440	10

(1) breaking capacity under 1 pole with IT isolated neutral system (case of double fault)

- service breaking capacity  $I_{cs} = 50\% I_{cu}$
- positive break indication
- fast closing ensures simultaneous closing of poles
- electrical durability:
  - 63 A: 10000 cycles (O-C)
  - 80...125 A: 5000 cycles (O-C)
- limitation class: 3
- mechanical durability: 20000 cycles (O-C)
- bistable fixing pawl: simplifies disassembly
- weight (g):

1P	2P	3P	4P
205	410	615	820

- approval: IMQ
- connection:
  - flexible cables: 1.5 to 35 mm<sup>2</sup>
  - rigid cables: 1 to 50 mm<sup>2</sup>
- terminals ensure:
  - degree of protection IP2
  - tightening of wide cross-section cables
  - pull-out withstand of cables
  - automatic guiding of cable into the correct position
- markers:
  - 4 marker clips next to the upstream terminal
  - label holder on handle (2P, 3P, 4P)
- degree of pollution: 3 (for use in an industrial environment)
- degree of protection:
  - open or surface mounted device: IP2
  - in a Pragma or Prisma enclosure: IP4 (IPxxD)

## B curve

- magnetic trip units operate between 3 and 5  $I_n$
- protection of very long cables
- protection of networks supplied by generators

## C curve

- magnetic trip units operate between 5 and 10  $I_n$
- protection of standard networks

## D curve

- magnetic trip units operate between 10 and 14  $I_n$
- protection of circuits that supply high inrush current loads: transformers, motors, etc.

# C120H Miniature circuit-breakers

B curve

IEC 898 : 15000 - IEC 947-2: 15 kA

## catalogue numbers



18394

type	rating (A)	catalogue number	width in mod. of 9 mm
<b>B curve C120H</b>			
1P 1 *  2	10	<b>18394</b>	3
	16	<b>18395</b>	3
	20	<b>18396</b>	3
	25	<b>18397</b>	3
	32	<b>18398</b>	3
	40	<b>18399</b>	3
	50	<b>18400</b>	3
	63	<b>18401</b>	3
	80	<b>18402</b>	3
	100	<b>18403</b>	3
	125	<b>18404</b>	3



18412

2P 1 3 * *  2 4	10	<b>18405</b>	6
	16	<b>18406</b>	6
	20	<b>18407</b>	6
	25	<b>18408</b>	6
	32	<b>18409</b>	6
	40	<b>18410</b>	6
	50	<b>18411</b>	6
	63	<b>18412</b>	6
	80	<b>18413</b>	6
	100	<b>18414</b>	6
	125	<b>18415</b>	6



18424

3P 1 3 5 * * *  2 4 6	10	<b>18416</b>	9
	16	<b>18417</b>	9
	20	<b>18418</b>	9
	25	<b>18419</b>	9
	32	<b>18420</b>	9
	40	<b>18421</b>	9
	50	<b>18422</b>	9
	63	<b>18423</b>	9
	80	<b>18424</b>	9
	100	<b>18425</b>	9
	125	<b>18426</b>	9



18437

4P 1 3 5 7 * * * *  2 4 6 8	10	<b>18427</b>	12
	16	<b>18428</b>	12
	20	<b>18429</b>	12
	25	<b>18430</b>	12
	32	<b>18431</b>	12
	40	<b>18432</b>	12
	50	<b>18433</b>	12
	63	<b>18434</b>	12
	80	<b>18435</b>	12
	100	<b>18436</b>	12
	125	<b>18437</b>	12

## additional information

electrical auxiliaries: page 21  
dimensions: page 31

# C120H Miniature circuit-breakers

C curve

IEC 898 : 15000 - IEC 947-2: 15 kA

## catalogue numbers



18445

type	rating (A)	catalogue number	width in mod. of 9 mm
<b>C curve C120H</b>			
1P 1 * 2	10	<b>18438</b>	3
	16	<b>18439</b>	3
	20	<b>18440</b>	3
	25	<b>18441</b>	3
	32	<b>18442</b>	3
	40	<b>18443</b>	3
	50	<b>18444</b>	3
	63	<b>18445</b>	3
	80	<b>18446</b>	3
	100	<b>18447</b>	3
	125	<b>18448</b>	3



18456

2P 1 3 * * 2 4	10	<b>18449</b>	6
	16	<b>18450</b>	6
	20	<b>18451</b>	6
	25	<b>18452</b>	6
	32	<b>18453</b>	6
	40	<b>18454</b>	6
	50	<b>18455</b>	6
	63	<b>18456</b>	6
	80	<b>18457</b>	6
	100	<b>18458</b>	6
	125	<b>18459</b>	6



18468

3P 1 3 5 * * * 2 4 6	10	<b>18460</b>	9
	16	<b>18461</b>	9
	20	<b>18462</b>	9
	25	<b>18463</b>	9
	32	<b>18464</b>	9
	40	<b>18465</b>	9
	50	<b>18466</b>	9
	63	<b>18467</b>	9
	80	<b>18468</b>	9
	100	<b>18469</b>	9
	125	<b>18470</b>	9



18481

4P 1 3 5 7 * * * * 2 4 6 8	10	<b>18471</b>	12
	16	<b>18472</b>	12
	20	<b>18473</b>	12
	25	<b>18474</b>	12
	32	<b>18475</b>	12
	40	<b>18476</b>	12
	50	<b>18477</b>	12
	63	<b>18478</b>	12
	80	<b>18479</b>	12
	100	<b>18480</b>	12
	125	<b>18481</b>	12

## additional information

electrical auxiliaries: page 21  
dimensions: page 31



# C120H Miniature circuit-breakers

D curve

IEC 898 : 15000 - IEC 947-2: 15 kA

## catalogue numbers



18482



18500



18514



18525

type	rating (A)	catalogue number	width in mod. of 9 mm	
<b>D curve C120H</b>				
1P 1 *  2	10	<b>18482</b>	3	
	16	<b>18483</b>	3	
	20	<b>18484</b>	3	
	25	<b>18485</b>	3	
	32	<b>18486</b>	3	
	40	<b>18487</b>	3	
	50	<b>18488</b>	3	
	63	<b>18489</b>	3	
	80	<b>18490</b>	3	
	100	<b>18491</b>	3	
	125	<b>18492</b>	3	
	2P 1 3 * *  2 4	10	<b>18493</b>	6
		16	<b>18494</b>	6
20		<b>18495</b>	6	
25		<b>18496</b>	6	
32		<b>18497</b>	6	
40		<b>18498</b>	6	
50		<b>18499</b>	6	
63		<b>18500</b>	6	
80		<b>18501</b>	6	
100		<b>18502</b>	6	
125		<b>18503</b>	6	
3P 1 3 5 * * *  2 4 6		10	<b>18504</b>	9
		16	<b>18505</b>	9
	20	<b>18506</b>	9	
	25	<b>18507</b>	9	
	32	<b>18508</b>	9	
	40	<b>18509</b>	9	
	50	<b>18510</b>	9	
	63	<b>18511</b>	9	
	80	<b>18512</b>	9	
	100	<b>18513</b>	9	
	125	<b>18514</b>	9	
	4P 1 3 5 7 * * * *  2 4 6 8	10	<b>18515</b>	12
		16	<b>18516</b>	12
20		<b>18517</b>	12	
25		<b>18518</b>	12	
32		<b>18519</b>	12	
40		<b>18520</b>	12	
50		<b>18521</b>	12	
63		<b>18522</b>	12	
80		<b>18523</b>	12	
100		<b>18524</b>	12	
125		<b>18525</b>	12	

## additional information

electrical auxiliaries: page 21  
dimensions: page 31

# NC100L Miniature circuit-breakers

C curve

IEC 947-2: 25 kA

## functions

The circuit-breakers combine the following functions:

- protecting circuits against short-circuit currents,
- protecting circuits against overload currents,
- control,

- disconnection,
- protecting persons against indirect contact in the TN and IT earthing systems

The NC100L circuit-breakers are used in the tertiary sector and industry.

## description

### common technical data

- power circuit:
- voltage rating: 415 V AC
- ratings: 10 to 63 A set at 40 °C
- breaking capacity:
- as in BS 3871 Pt1:

rating (A)	type	voltage (V)	break. cap. (kA)
10...40	1P	240	16
	2P, 3P, 4P	415	16

50...63	1P	240	10
	2P, 3P, 4P	415	10

- as in IEC 947-2, Icu ultimate breaking capacity and BS 4752 (O-CO cycle):

rating (A)	type	voltage (V)	break. cap. Icu (kA)
10...63	1P	130	50
		220...240	25
		400...415	6
2P, 3P, 4P		220...240	50
		380...415	25

- fast closing: allows increased withstand of the high inrush currents of some loads
- disconnection with positive contact indication: pole opening is indicated by the mechanical indicator (green) on the front face of the device. This indicator shows that all the poles are open.
- number of operating cycles (O-C): 20 000

### environment:

- tropicalisation: treatment 2 (relative humidity 95 % at 55 °C)

□ weight (g):

type	1P	2P	3P	4P
	180	360	540	720

- connection: tunnel terminals for 25 mm<sup>2</sup> flexible cables or 35 mm<sup>2</sup> rigid cables

- identification: each device comes with a label holder on the toggle

- installation: in Multi 9 or Prisma enclosures

## C curve

### use

cables supplying standard loads

### technical data

#### ■ power circuit:

- tripping curve:

the magnetic releases operate between 7 and 10 I<sub>n</sub>.

## catalogue numbers



27628

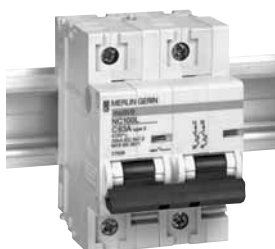

27639

type	rating (A)	catalogue number	width in mod. of 9 mm
------	------------	------------------	-----------------------

### NC100L C curve

type	rating (A)	catalogue number	width in mod. of 9 mm
1P 	10	27621	3
	16	27622	3
	20	27623	3
	25	27624	3
	32	27625	3
	40	27626	3
	50	27627	3
	63	27628	3

2P 	10	27632	6
	16	27633	6
	20	27634	6
	25	27635	6
	32	27636	6
	40	27637	6
	50	27638	6
	63	27639	6

# NC100L Miniature circuit-breakers

C curve

IEC 947-2: 25 kA

## catalogue numbers



27650



27661

type	rating (A)	catalogue number	width in mod. of 9 mm
------	------------	------------------	-----------------------

### NC100L C curve (continued)

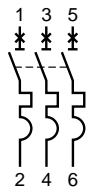
type	rating (A)	catalogue number	width in mod. of 9 mm
3P 	10	<b>27643</b>	9
	16	<b>27644</b>	9
	20	<b>27645</b>	9
	25	<b>27646</b>	9
	32	<b>27647</b>	9
	40	<b>27648</b>	9
	50	<b>27649</b>	9
	63	<b>27650</b>	9

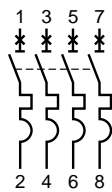
type	rating (A)	catalogue number	width in mod. of 9 mm
4P 	10	<b>27654</b>	12
	16	<b>27655</b>	12
	20	<b>27656</b>	12
	25	<b>27657</b>	12
	32	<b>27658</b>	12
	40	<b>27659</b>	12
	50	<b>27660</b>	12
	63	<b>27661</b>	12

## additional information

electrical auxiliaries: page 22  
dimensions: page 31

# NC100LH Miniature circuit-breakers

C curve

IEC 947-2: 50 kA

## functions

The circuit-breakers combine the following functions:

- protecting circuits against short-circuit currents,
- protecting circuits against overload currents,
- control,

- disconnection,
- protecting persons against indirect contact in the TN and IT earthing systems.

The NC100LH circuit-breakers are used in the tertiary sector and industry.

## description

### common technical data

- power circuit:
- voltage rating: 415 V AC
- ratings: 10 to 63 A set at 40 °C
- breaking capacity as in IEC 947-2, Icu ultimate breaking capacity and BS 4752 (O-CO cycle):

rating (A)	type	voltage (V)	break. cap. Icu (kA)
10...63	1P	220...230	50
		240	40
		400	12,5
		415	10 (1)
	2P, 3P, 4P	220...230	100
		400	50
		415	40
		440	30

(1) 1 pole breaking capacity in the IT unearthed neutral system (double fault)

- fast closing: allows increased withstand of the high inrush currents of some loads
- disconnection with positive contact indication: pole opening is indicated by the mechanical indicator (green) on the front face of the device. This indicator shows that all the poles are open.
- number of operating cycles (O-C): 20 000

### ■ environment:

- tropicalisation: treatment 2 (relative humidity 95 % at 55 °C)

□ weight (g):

type	1P	2P	3P	4P
	180	360	540	720

- connection: tunnel terminals for 25 mm<sup>2</sup> flexible cables or 35 mm<sup>2</sup> rigid cables
- identification: each device comes with a label holder on the toggle

□ installation: in Multi 9 or Prisma enclosures

## C curve

### use

cables supplying standard loads

### technical data

#### ■ power circuit:

□ tripping curve:

the magnetic releases operate between 7 and 10 I<sub>n</sub>.

## catalogue numbers



27516



27527

type	rating (A)	cat. no.	width in mod. of 9 mm
<b>NC100LH C curve</b>			

1P



10
16
20
25
32
40
50
63

<b>27509</b>	3
<b>27510</b>	3
<b>27511</b>	3
<b>27512</b>	3
<b>27513</b>	3
<b>27514</b>	3
<b>27515</b>	3
<b>27516</b>	3

2P



10
16
20
25
32
40
50
63

<b>27520</b>	6
<b>27521</b>	6
<b>27522</b>	6
<b>27523</b>	6
<b>27524</b>	6
<b>27525</b>	6
<b>27526</b>	6
<b>27527</b>	6

# NC100LH Miniature circuit-breakers

C curve

IEC 947-2: 50 kA

## catalogue numbers



27538



27549

type	rating (A)	catalogue number	width in mod. of 9 mm
------	------------	------------------	-----------------------

### NC100LH C curve (continued)

3P	rating (A)	catalogue number	width in mod. of 9 mm
	10	<b>27531</b>	9
	16	<b>27532</b>	9
	20	<b>27533</b>	9
	25	<b>27534</b>	9
	32	<b>27535</b>	9
	40	<b>27536</b>	9
	50	<b>27537</b>	9
	63	<b>27538</b>	9

4P	rating (A)	catalogue number	width in mod. of 9 mm
	10	<b>27542</b>	12
	16	<b>27543</b>	12
	20	<b>27544</b>	12
	25	<b>27545</b>	12
	32	<b>27546</b>	12
	40	<b>27547</b>	12
	50	<b>27548</b>	12
	63	<b>27549</b>	12

## additional information

electrical auxiliaries: page 22  
 dimensions: page 31

# electrical auxiliaries for C60, C120

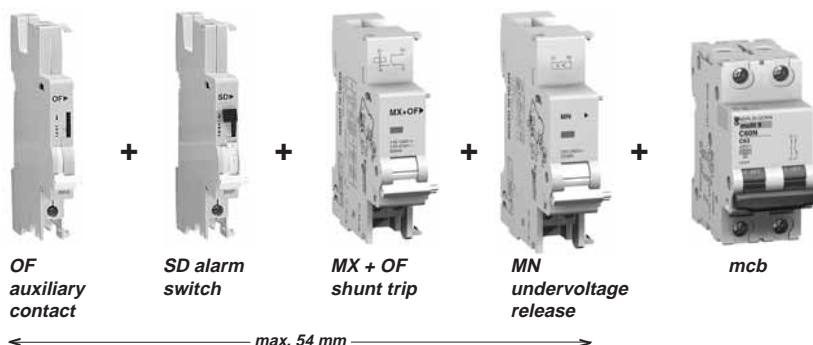

## MX + OF shunt trip release



26946

type	width in mod. of 9 mm	voltage	cat. No.
<b>MX + OF 2</b>		220-415 V AC 110-130 V DC	<b>26946</b>
		48-130 V DC 48V AC	<b>26947</b>
		24 V AC and V DC	<b>26948</b>

### MX + OF

type	width in mod. of 9 mm	voltage	cat. No.
<b>instantaneous</b>			
<b>MN</b>	<b>2</b>	24 V AC and V DC 48 V AC 48 V DC	<b>26948</b> <b>26961</b> <b>26962</b>
<b>time delayed 0.5 s</b>			
<b>MN</b>	<b>4</b>	220-240 V AC	<b>26963</b>

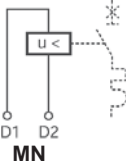

**MN**

## MX + OF shunt trip release



26946

## SD alarm switch



26927

type	width in mod. of 9 mm	cat. No.
<b>SD</b>	<b>1</b>	<b>26927</b>

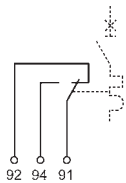

**SD**

## OF auxiliary switch



26924

type	width in mod. of 9 mm	cat. No.
<b>OF</b>	<b>1</b>	<b>26924</b>

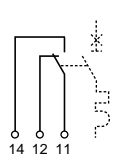

**OF**

## Applications

C60 auxiliaries enable remote tripping or remote indication of the ON/OFF positions of an mcb.

They are mounted by clipping on the left hand side of the mcb/rcd.

In addition to the above Vigi module can always be assembled on the right hand side of an mcb.

## Remote Tripping

### ■ MX + OF shunt trip release:

- enables the mcb to be tripped from a remote location,
- allows remote indication of the "OFF" or "ON" position of the mcb by using the same voltage as the one feeding the shunt trip (terminals 12 and 14),
- is equipped with a cut-off switch in series with the coil,
- all shunt trip release devices are equipped with a red flag trip indicator;

### ■ MN undervoltage release

- enables miniature circuit breakers to be tripped either when the voltage drops or by operation of the "OFF" push button of a remote device tripping between 70 and 35% Un, closing  $\geq 85\%$  Un,
- prevents the mcb from being switched "ON" again if the undervoltage release supply is not present,

### ■ MN <sup>S</sup> undervoltage release, time delayed:

- allows micro breaks  $\leq 200$  ms without effects,
- all under voltage release are equipped with a red flag indicator.

## Consumption of releases

type	voltage (V AC or V DC)	(W or VA)
<b>MX</b>	415V AC pickup	120
	200-240 V AC pickup	50
	110-130 V AC pickup	200
	110-130 V DC pickup	10
	48 V AC or V DC pickup	22
<b>MN</b>	24 V AC or V DC pickup	120
	220-240 V AC hold	4.1
	48 V AC hold	4.3
<b>MN <sup>S</sup></b>	48 V DC hold	2.0
	220-240 V AC hold	4.1

## Remote indication

### ■ SD alarm switch

An indicating device which monitors the tripping of an mcb.

This device offers the following:

- a red flag trip indicator,
- ability to reset without closing the mcb,
- test function;

### ■ OF auxiliary switch

□ a changeover switch which acts as an indicating or control device to monitor the "ON" or "OFF" positions of an mcb;

□ ability to reset without closing the mcb,

■ breaking capacity of auxiliary contacts.

voltage (V AC or V DC)	breaking capacity (A)
415 V AC	3
$\leq 240$ V AC	6
130 V DC	1
$\leq 48$ V DC	2
$\leq 24$ V DC	6

■ connection: screw clamp terminal for 1 cable 2.5mm<sup>2</sup> (or 2 x 1.5mm<sup>2</sup>)

# electrical auxiliaries for NC100

## functions

Remote tripping and indication of NC100 circuit-breakers.

## description

### auxiliary combinations

- Mounted to the left of the circuit-breaker (SD and OF).
- Mounted to the right of the circuit-breaker (MX + OF and MN).

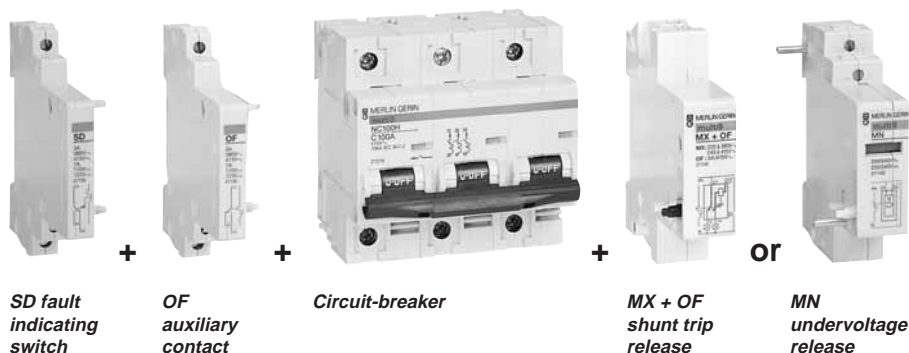

### remote tripping

By means of an MX shunt trip or MN undervoltage release.

#### MX + OF shunt trip release

When energised, trips and opens the circuit-breaker with which it is associated:

- fitted with a cut-off contact
- fitted with an O + F contact that indicates the «open» or «closed» position of the circuit-breaker.

#### MN undervoltage release

When its supply voltage drops (between 70 and 35%) it trips and opens the circuit-breaker with which it is associated, and prevents reclosing of this circuit-breaker until its supply voltage is restored:

- complies with IEC 947-2 and IEC 157-1 standards
- use:
  - emergency stop via push button
  - safety feature on circuit supplying several machines preventing «uncontrolled» restarting of the motors.

#### MN time-delayed undervoltage release

Undervoltage release controlling opening of the circuit-breaker with which it is associated. Allows a 0.5 second time delay on a short supply interruption or voltage drop.

#### technical data

■ consumption of releases

type	voltage	
	(V CA or V CC)	(W or VA)
MX	AC	pick-up 240
	DC	pick-up 200
MN	AC	holding 4,1
	DC	holding 4,1
MN 	AC	holding 4,1
	DC	holding 4,1

### remote indication

#### OF contact

■ this auxiliary contact installed to the left of the circuit-breaker indicates the «open» or «closed» position of the circuit-breaker.

#### SD fault indicating switch

■ this auxiliary switch installed to the left of the circuit-breaker indicates the «tripped on fault» position of the circuit-breaker.  
 ■ visualisation of the fault on the front panel by mechanical indicator lamp.

#### technical data

■ breaking capacity of the auxiliary switches

voltage (V AC or DC)	breaking capacity (A)
415 V	AC 3
≤ 240 V	AC 6
130 V	DC 1
≤ 48 V	DC 2
≤ 24 V	DC 6

#### technical data common to the auxiliaries

■ connection: terminal pads for two 1.5 mm<sup>2</sup> cables or one 2.5 mm<sup>2</sup> cable.

# electrical auxiliaries for NC100

## catalogue numbers



27136



27140



27132



27135

type	control voltage		catalogue number	width in mod. of 9 mm
	(V AC)	(V DC)		

### MX + OF shunt trip release

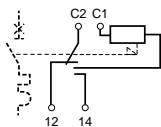

220...415		<b>27136</b>	2
110...220	110...125	<b>27137</b>	2
24...48	24...48	<b>27138</b>	2

### MN undervoltage release

instantaneous	220...240	220...240	<b>27140</b>	2
---------------	-----------	-----------	--------------	---

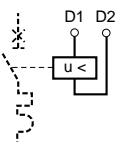

time-delayed 	220...240	220...240	<b>27143</b>	2
--	-----------	-----------	--------------	---

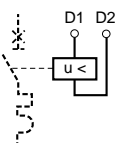

### OF auxiliary contact

			<b>27132</b>	1
--	--	--	--------------	---

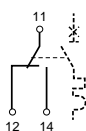

### SD fault indicating switch

			<b>27135</b>	1
--	--	--	--------------	---

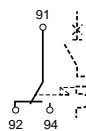

## additional information

dimensions: page 31



# instantaneous RCCB/ELCB, selective RCCB/ELCB

30 mA to 300 mA instantaneous

300 mA **S** selective

⌚ protected against nuisance tripping

## functions

The residual current circuit breakers combine the following functions:  
 - control  
 - automatic breaking of a circuit if an insulation fault occurs between the phase

and earth that is greater than or equal to 10,30,300 mA.  
 The residual current circuit breakers are used in the residential, tertiary and industrial sectors.

## description

The residual current release is an electromechanical device operating without any auxiliary source of supply.

### common technical data

- in the presence of devices containing rectifying units (diodes, thyristors, triacs), use an A class instantaneous residual current circuit breaker guaranteeing tripping in the presence of a dc component .
- provides protection against nuisance tripping due to transient overvoltages (lightning, switchgear switching on the network, etc.).
- Level of immunity: 250A peak as in 8/20 ms periodical wave
- power circuit:
  - operational voltage:
    - 240... 415 V AC, +10, -20 %, 50 Hz
  - operational current: up to 100 A
  - disconnection with positive contact indication
  - increased short-circuit current withstand
  - number of operating cycles (O-C): 20 000
- release:
  - instantaneous or selective release: fixed sensitivities for all ratings
- manual operating mechanism: handle
- indication:
  - mechanical: the residual current fault is shown on the front face by a mechanical indicator
  - electrical: by the SD indication auxiliary

- environment:
  - tropicalisation: treatment 2 (relative humidity 95% at 55 °C)
  - weight (g)

type	2P	4P
	230	450

- connection
  - tunnel terminals for 35 mm<sup>2</sup> flexible cables or 50 mm<sup>2</sup> for rigid cables
- complies with the standards: IEC 1008 and EN 61-008. Rccb 2P 40...80 A and 4 P 40...63 A are approved by SIRIM.

### instantaneous RCCB/ELCB technical data

- instantaneous release

### selective RCCB/ELCB **S** technical data

- selective release allowing total vertical discrimination where the 30 mA residual current devices are placed downstream.

## catalogue numbers



16206

type	voltage (V AC)	rating (A)	sensitivity (mA)
------	----------------	------------	------------------

### ID residual current switches AC class

2P	240	40	30	
			100	
			300	
	63			30
				100
				300
	80			300 <b>S</b>
				30
				100
	100			300
				30
				100
			300 <b>S</b>	

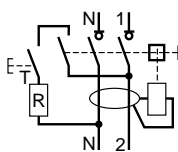

catalogue number	width in mod. of 9 mm
------------------	-----------------------

16204	4
16205	4
16206	4
16208	4
16209	4
16210	4
16246	4
16212	4
16213	4
16214	4
16216	4
16217	4
16218	4
16248	4

# instantaneous RCCB/ELCB, selective RCCB/ELCB

30 mA to 300 mA instantaneous

300 mA **S** selective

## catalogue numbers



16260

type	voltage (V AC)	rating (A)	sensitivity (mA)	catalogue number	width in mod. of 9 mm
------	-------------------	---------------	---------------------	---------------------	-----------------------------

**RCCB/ELCB residual current circuit breakers AC class (continued)**

4P	415	40	30	<b>16254</b>	8	
			100	<b>16255</b>	8	
			300	<b>16256</b>	8	
			63	30	<b>16258</b>	8
			100	<b>16259</b>	8	
			300	<b>16260</b>	8	
			300 <b>S</b>	<b>16265</b>	8	
			80	30	<b>16261</b>	8
			300	<b>16263</b>	8	
			300 <b>S</b>	<b>16266</b>	8	

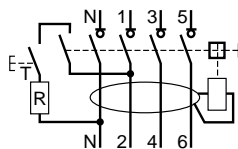

## additional information

electrical auxiliaries: page 26  
dimensions: page 31

# electrical auxiliaries for RCCB/ELCB

## functions

These electrical auxiliaries are used for remote indication or tripping of the residual current circuit breakers.

## description

### auxiliary combinations

They are mounted on the lefthand side of the residual current circuit breaker within a 54 mm width.

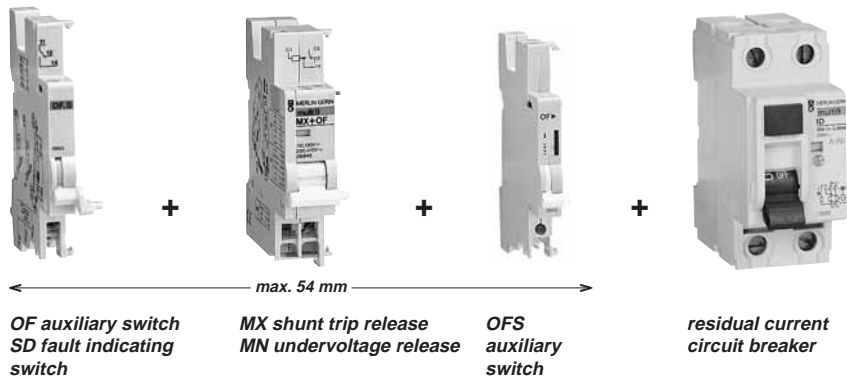

### remote tripping

A MX or MN release can be used for this purpose. Tripping is shown by a red indicator on the front face.

#### MX + OF shunt trip release

trips and opens its associated circuit-breaker when energised:

- equipped with a self-breaking switch
- equipped with a switch (terminals 12 and 14) to indicate whether the circuit-breaker is «opened» or «closed» when the coil is energised.

#### MN undervoltage release

trips and opens its associated circuit-breaker when the supply voltage drops (between 70 and 35%) and prevents reclosing until the supply voltage is restored:

- complies with standards IEC 947-2
- use:
  - push button emergency stop
  - safety on the supply circuits of several machines by disabling «uncontrolled» restart of all motors.

#### MN time delayed undervoltage release S

This undervoltage release controls the opening of its associated residual current switch. It allows a 0.5 second time delay on short supply interruptions or voltage drops

#### characteristics

- consumption of releases

type	voltage		consumption	
	(V AC or DC)	(W or VA)		
MX	415 V	AC	inrush	120
	220...240 V	AC	inrush	50
	110...130 V	AC	inrush	200
		DC	inrush	10
	48 V	AC	inrush	22
		DC	inrush	22
24 V	AC	inrush	120	
	DC	inrush	120	
MN	220...240 V	AC	hold	4.1
	48 V	AC	hold	4.3
		DC	hold	2.0
MN <span style="border: 1px solid black; padding: 0 2px;">S</span>	220...240 V	AC	hold	4.1

### remote indication

#### OFS switch

- use of the OFS switch is compulsory for adding the MN, MX, SD and OF functions.
- fixed on the lefthand side of the residual current switch, it indicates whether the switch is «open or «closed».

#### OF switch

- fixed on the lefthand side of the residual current switch, it indicates whether the switch is «open or «closed».

#### SD fault indicating switch

- this auxiliary switch installed to the left of the circuit-breaker indicates the «tripped on fault» position of the circuit-breaker.
- visualisation of the fault on the front panel by mechanical indicator lamp.

#### characteristics

- breaking capacity of the auxiliary switches

voltage (V AC or DC)	breaking capacity	
		(A)
415 V	AC	3
≤ 240 V	AC	6
130 V	DC	1
≤ 48 V	DC	2
≤ 24 V	DC	6

#### common auxiliary characteristics

- connection by pad terminals for 2 cables 1.5 mm<sup>2</sup> or 1 cable 2.5 mm<sup>2</sup>.

#### operation simulation

A test button on the front face of the OF switches is used to simulate the OF functions without using the residual current circuit breaker.

# electrical auxiliaries for RCCB/ELCB

## catalogue numbers



26946



26960



26923



26927



26924

type	control voltage (V AC) (V DC)		catalogue number	width in mod. of 9 mm
------	----------------------------------	--	------------------	-----------------------

### MX + OF shunt trip release

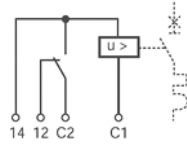

220...415	110...130
48...130	48
24	24

<b>26946</b>	2
<b>26947</b>	2
<b>26948</b>	2

### MN undervoltage release

instantaneous

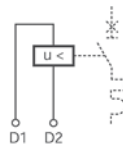

220...240	
48	48

<b>26960</b>	2
<b>26961</b>	2
<b>26962</b>	2

time delayed

220...240	
-----------	--

<b>26963</b>	4
--------------	---

### OFS auxiliary switch

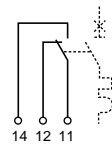

<b>26923</b>	1
--------------	---

### SD fault indicating switch

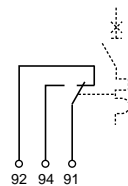

<b>26927</b>	1
--------------	---

### OF auxiliary switch

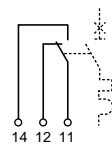

<b>26924</b>	1
--------------	---

## additional information

dimensions: page 31

# discrimination

**upstream: C60a, N, H, L, C Curve**

**downstream: C60a, N, H, L**

upstream		C60a, N, H, L											
In (A)		C curve											
downstream		2	3	4	6	10	16	20	25	32	40	50	63
C60a, N, H, L	(A)	15	23	30	45	75	120	150	188	240	300	375	473
C curve	1												
	2												
	3												
	4												
	6												
	10												
	16												
	20												
	25												
	32												

# discrimination

**upstream: Merlin Gerin multi 9**  
**downstream: Merlin Gerin multi 9**

downstream	upstream In (A) rating I <sub>r</sub>	NS100N/H/L Trip unit TM-D								NS160N/H/L trip unit TM-D			
		16	25	32	40	50	63	80	100	80	100	125	160
<b>C60a</b> curve C	≤10	0.19	0.3	0.4	0.5	0.5	0.5	0.63	0.8	T	T	T	T
	16		0.3	0.4	0.5	0.5	0.5	0.63	0.8	T	T	T	T
	20			0.4	0.5	0.5	0.5	0.63	0.8	T	T	T	T
	25				0.5	0.5	0.5	0.63	0.8	T	T	T	T
	32						0.5	0.63	0.8	T	T	T	T
	40						0.5	0.63	0.8	T	T	T	T
<b>C60N</b> curve C	≤10	0.19	0.3	0.4	0.5	0.5	0.5	0.63	0.8	T	T	T	T
	16		0.3	0.4	0.5	0.5	0.5	0.63	0.8	T	T	T	T
	20			0.4	0.5	0.5	0.5	0.63	0.8	T	T	T	T
	25				0.5	0.5	0.5	0.63	0.8	T	T	T	T
	32						0.5	0.63	0.8	T	T	T	T
	40						0.5	0.63	0.8	T	T	T	T
	50							0.63	0.8	T	T	T	T
	63								0.8	T	T	T	T
<b>C120N/H</b> curve C	63										2.5	2.5	2.5
	80												2.5
	100												2.5
<b>NC100L</b>	≤16			0.4	0.5	0.5	0.5	0.63	0.8	T	T	T	T
	20			0.4	0.5	0.5	0.5	0.63	0.8	T	T	T	T
	25					0.5	0.5	0.63	0.8	T	T	T	T
	32						0.5	0.63	0.8	T	T	T	T
	40						0.5	0.63	0.8	T	T	T	T
	50							0.63	0.8	T	T	T	T
<b>NC100LH</b> curve C	≤16			0.4	0.5	0.5	0.5	0.63	0.8	T	T	T	T
	20			0.4	0.5	0.5	0.5	0.63	0.8	T	T	T	T
	25					0.5	0.5	0.63	0.8	T	T	T	T
	32						0.5	0.63	0.8	T	T	T	T
	40							0.63	0.8	T	T	T	T
	50							0.63	0.8	T	T	T	T
63								0.8	T	T	T	T	

### Using the tables

Two circuit breakers offer total discrimination when the corresponding box in the discrimination table is shaded or contains the letter T.

When discrimination is partial for the combination, the corresponding box indicates the maximum value of the fault current for which discrimination is provided. For fault currents above this value, the two circuit breakers trip simultaneously.

## cascading

230/240 V network

**upstream: Merlin Gerin multi 9**

**downstream: Merlin Gerin multi 9**

upstream cb	C60a	C60N	C60H	C60H	C120N	NC100L	NC100LH
rated breaking capacity kA rms	10	20	30	20	30	50	100
downstream cb	rated breaking capacity						
C60a		20	30	20	30	50	100
C60N			30		30	50	100

**upstream: Merlin Gerin Compact**

**downstream: Merlin Gerin multi 9**

upstream cb	NS100N	NS100H	NS100L	NS160N	NS160H	NS160L	NS250N	NS250H	NS250L
rated breaking capacity kA rms	85	100	150	85	100	150	85	100	100
downstream cb	rated breaking capacity								
C60a	30	80	80	30	40	40	30	40	40
C60N	40	100	100	40	60	60	40	60	60
C120N	40	50	70	40	50	70	40	50	70
C120H	40	50	70	40	50	70	40	50	70

## cascading

400/415 V network

**upstream: Merlin Gerin multi 9**

**downstream: Merlin Gerin multi 9**

upstream cb	C60N	C60H	C60H	C120N	NC100L	NC100LH
rated breaking capacity kA rms	10	15	10	15	25	50
downstream cb	rated breaking capacity					
C60a	10	15	10	15	25	50
C60N		15		15	25	50

**upstream: Merlin Gerin Compact**

**downstream: Merlin Gerin multi 9**

upstream cb	NS100N	NS100H	NS100L	NS160N	NS160H	NS160L	NS250N	NS250H	NS250L
rated breaking capacity kA rms	36	70	150	36	70	150	36	70	150
downstream cb	rated breaking capacity								
C60a	15	20	20	15	20	20	15	20	20
C60N	25	30	30	25	30	30	25	30	30
C120N	25	25	25	25	25	25	25	25	25
C120H	25	25	25	25	25	25	25	25	25

# dimensions

## multi 9

### C60 circuit breakers

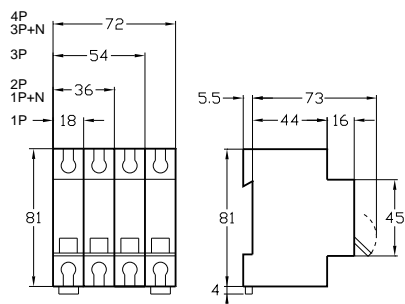

### C120 circuit breakers

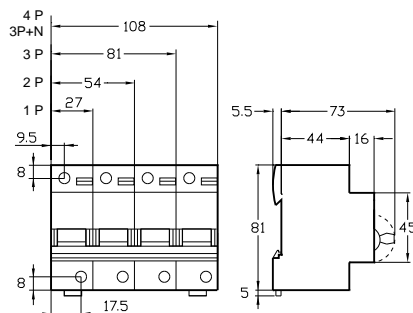

### Auxiliaries for C60, C120, ID/RCCB

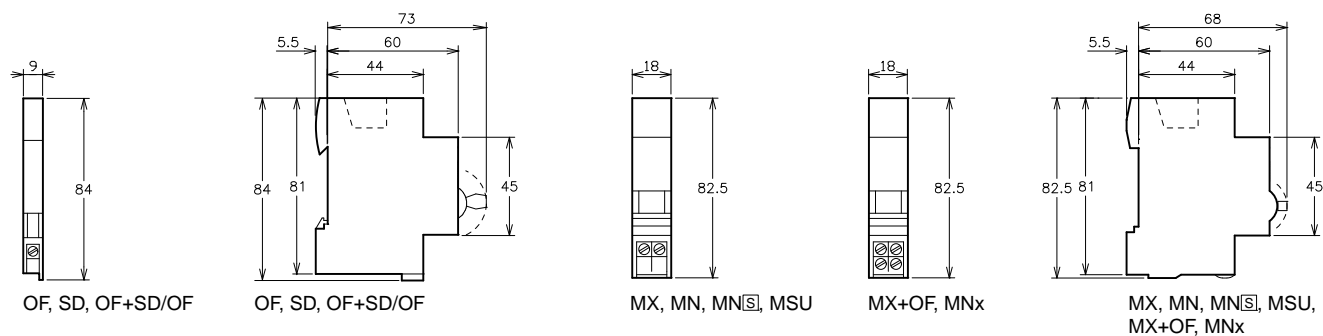

### NC100 circuit breakers

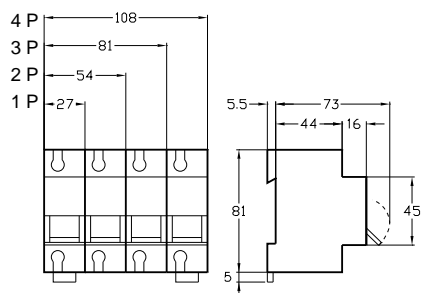

### Auxiliaries

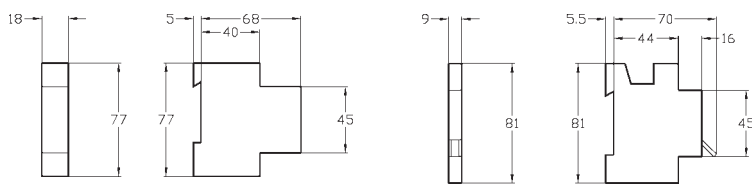

### RCCB

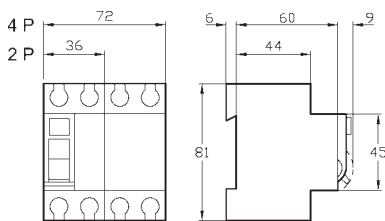

### Auxiliaries

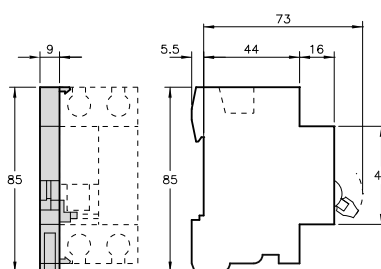



## **MULTI 9 Consumer Unit**

### **Mini Pragma Din-Kit Semi-equipped Consumer Unit**

Mini Pragma Din-Kit Semi-equipped Consumer Unit comprising :-

- one enclosure
- one incoming fuse-switch / circuit breaker / isolator
- one earth leakage circuit breaker

ONE complete consumer unit = ONE Mini Pragma Din-Kit plus

Outgoing Domae MCBs

Ease of selection

Robust design for all building requirements

Resistant to impacts, scratches, humidity as it is made of insulating, self-extinguishing material

(compliant to IEC 529 : IP40 and IEC 695-2-1 casing : 650°C / 30s)



Number of Ways (Enclosure)	Din-Kit Reference	Incoming Rating	Contents	Available Ways for Outgoing Domae 1P MCBs
12	DK12FS33E410	32	12-way Mini Pragma Enclosure X1 SFT 32A 1P+N Fuse Switch X1 Domae ELCB 40A 2P 100mA X1	9
12	DK12MA42E410	40	12-way Mini Pragma Enclosure X1 Domae 1P+N 40A MCB 4.5kA X1 Domae ELCB 40A 2P 100mA X1	8
12	DK12IS62E410	40	12-way Mini Pragma Enclosure X1 Isolator 2P 63A X1 Domae ELCB 40A 2P 100mA X1	8
12	DK12MA62E610	63	12-way Mini Pragma Enclosure X1 Domae 1P+N 63A MCB 4.5kA X1 Domae ELCB 63A 2P 100mA X1	8
12	DK12IS62E610	63	12-way Mini Pragma Enclosure X1 Isolator 2P 63A X1 Domae ELCB 63A 2P 100mA X1	8
18	DK18FS33E410	32	18-way Mini Pragma Enclosure X1 SFT 32A 1P+N Fuse Switch X1 Domae ELCB 40A 2P 100mA X1	15
18	DK18MA42E410	40	18-way Mini Pragma Enclosure X1 2P 40A MCB 4.5kA X1 Domae ELCB 40A 2P 100mA X1	14
18	DK18IS62E410	40	18-way Mini Pragma Enclosure X1 Isolator 2P 63A X1 Domae ELCB 40A 2P 100mA X1	14
18	DK18MA62E610	63	18-way Mini Pragma Enclosure X1 Domae 1P+N 63A MCB 4.5kA X1 Domae ELCB 63A 2P 100mA X1	14
18	DK18IS62E610	63	18-way Mini Pragma Enclosure X1 Isolator 2P 63A X1 Domae ELCB 63A 2P 100mA X1	14
24	DK24MA62E610	63	24-way Mini Pragma Enclosure X1 Domae 1P+N 63A MCB 4.5kA X1 Domae ELCB 63A 2P 100mA X1	20
24	DK24IS62E610	63	24-way Mini Pragma Enclosure X1 Isolator 2P 63A X1 Domae ELCB 63A 2P 100mA X1	20

Note : For other combination, please consult us.

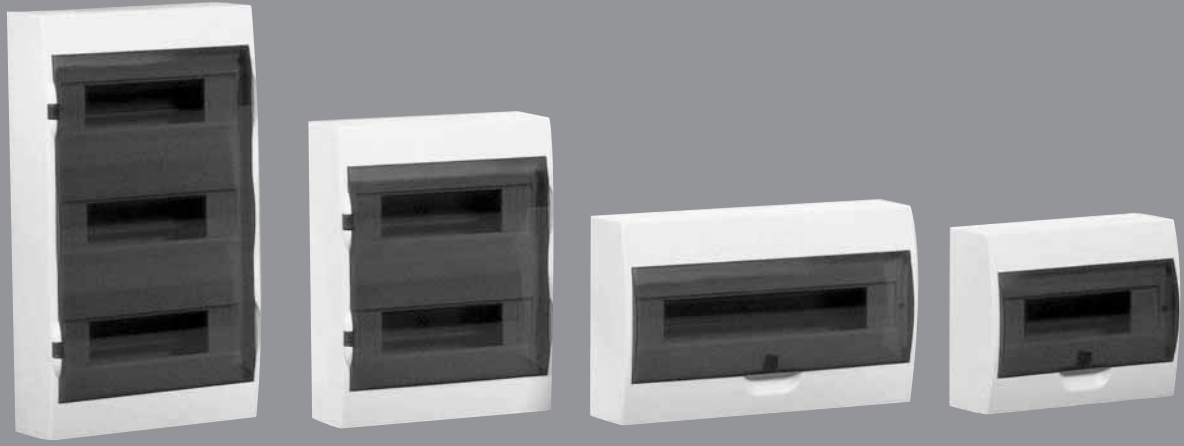

Merlin Gerin

# *Mini Pragma Din Kit*



Semi equipped  
consumer unit

Take full advantage of Merlin Gerin's experience and know-how.

Discover **Mini Pragma Din Kit** — a new range of semi equipped consumer units comprising, in a single catalogue number, of:

- one enclosure (12 / 18 / 24 / 36-way)
- one incoming circuit-breaker or isolator
- one earth leakage circuit breaker

You can expect:

- ease of selection
- a robust design for all building requirements
- resistant to impacts, scratches, humidity as it is made of insulating, self-extinguishing material (compliant to IEC 529:IP40 and IEC 695-2-1 casing: 650°C / 30s)
- surface mounted with a sealable front face

**Merlin Gerin Mini Pragma Din Kit**, an offer for everyday comfort!

**Schneider Electric Industries (M) Sdn Bhd (378576-M)**

***Shah Alam (HQ)***

No. 11, Jalan U1/19, Seksyen U1,  
Hicom-Glenmarie Industrial Park,  
Shah Alam 40150, Selangor,  
Malaysia

Tel : (603) 7883 6333  
Fax : (603) 7883 6188

**Customer Care: 1-800-880-877**

Email : [care@my.schneider-electric.com](mailto:care@my.schneider-electric.com)

Website : [www.schneider-electric.com.my](http://www.schneider-electric.com.my)

***Johor Bahru Branch***

Tel : (607) 351 3801  
Fax : (607) 351 4113

***Ipoh Branch***

Tel : (605) 527 1375  
Fax : (605) 527 1375

***Prai Branch***

Tel : (604) 398 3981 / 2  
Fax : (604) 398 3984

***Kota Kinabalu Branch***

Tel : (6088) 237 012  
Fax : (6088) 216 900

***Kuching Branch***

Tel : (6082) 368 428  
Fax : (6082) 361 855

***Services Hotline***

Tel : (603) 7883 6238 (24 Hrs)

As standards, specifications and designs change from time to time, please ask for confirmation of the information given in this publication.

Design, production, illustrations: Schneider Electric Industries (M) Sdn Bhd  
Printed in Malaysia