

# CONRADTY- CONOX<sup>®</sup> METAL OXIDE VARISTORS

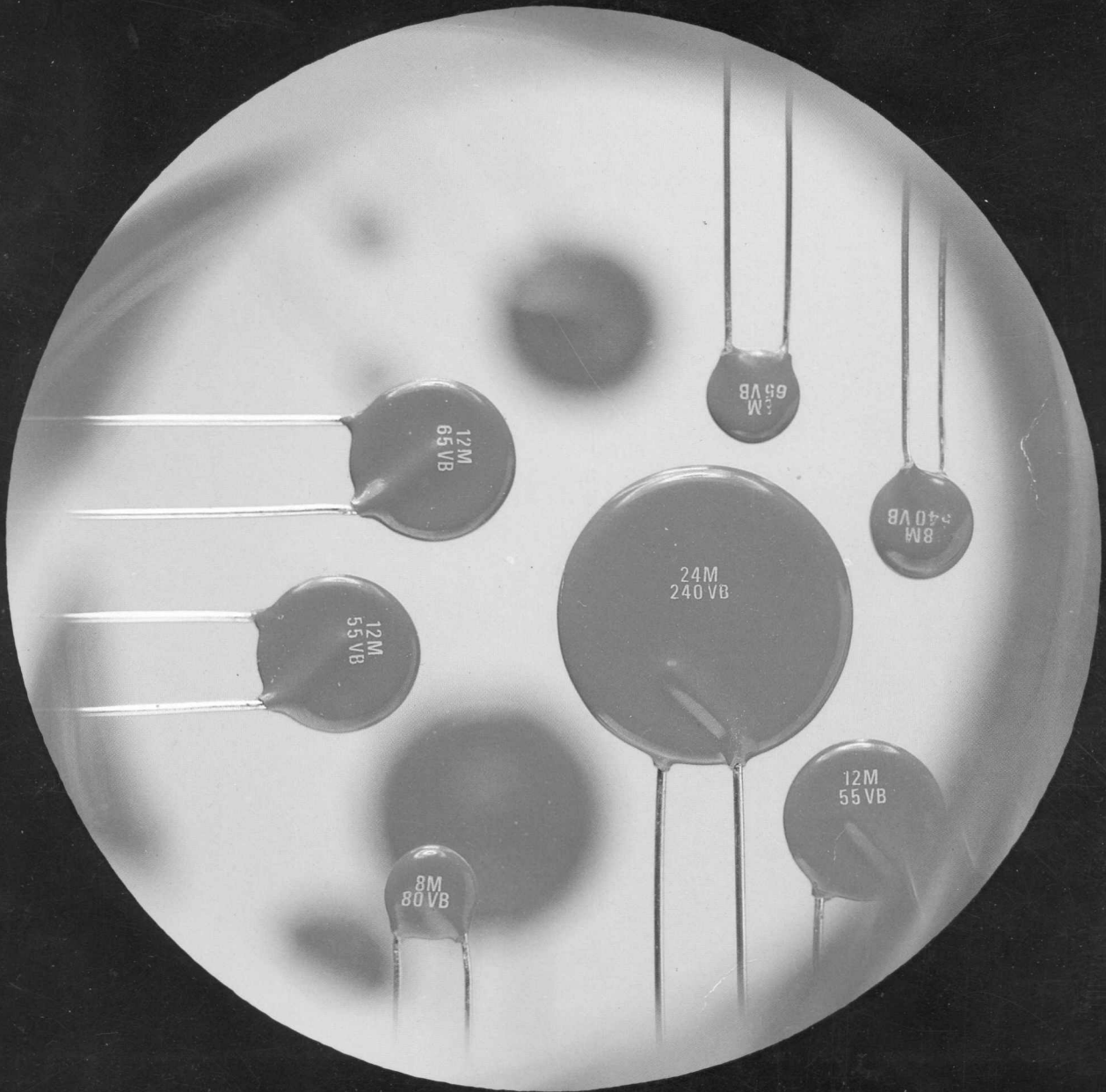

**C. CONRADTY  
NÜRNBERG** GmbH & Co. KG

# CONOX<sup>®</sup> METAL OXID VARISTORS

## Table of Contents

1	General	1
2	Design	2
3	Applications	3
4	Scope of application	4
5	Type selection	5
6	First description of the standards	6
7	Product range	7
8	Selection criteria	8
9	Operating voltage	9.1
10	Energy absorption	9.2
11	Surge current	9.3
12	Protective level	9.4
13	Voltage	9.5
14	Capacitance	9.6
15	Power dissipation	9.7
16	Operating temperature range	9.8
17	Response time	9.9
18	Technical data	10
19	Table of varistors 25 to 120 V	10.1
20	Table of varistors 200 to 540 V	10.2
21	Characteristic curves and diagrams	11
22	UI characteristic 1 : 5M	11.1
23	Diagram 1 : 5M	11.2
24	UI characteristic 2 : 5M	11.3
25	Diagram 2 : 5M	11.4
26	UI characteristic 3 : 15M	11.5
27	Diagram 3 : 15M	11.6
28	UI characteristic 4 : 15M	11.7
29	Diagram 4 : 15M	11.8
30	UI characteristic 5 : 30M	11.9
31	Diagram 5 : 30M	11.10
32	UI characteristic 6 : 30M	11.11
33	Diagram 6 : 30M	11.12
34	UI characteristic 7 : 30M	11.13
35	Diagram 7 : 30M	11.14
36	UI characteristic 8 : 30M	11.15
37	Diagram 8 : 30M	11.16
38	UI characteristic 9 : 30M	11.17
39	Diagram 9 : 30M	11.18
40	UI characteristic 10 : 30M	11.19
41	Diagram 10 : 30M	11.20
42	UI characteristic 11 : 30M	11.21
43	Diagram 11 : 30M	11.22
44	UI characteristic 12 : 30M	11.23
45	Diagram 12 : 30M	11.24
46	UI characteristic 13 : 30M	11.25
47	Diagram 13 : 30M	11.26
48	UI characteristic 14 : 30M	11.27
49	Diagram 14 : 30M	11.28
50	UI characteristic 15 : 30M	11.29
51	Diagram 15 : 30M	11.30
52	UI characteristic 16 : 30M	11.31
53	Diagram 16 : 30M	11.32
54	UI characteristic 17 : 30M	11.33
55	Diagram 17 : 30M	11.34
56	UI characteristic 18 : 30M	11.35
57	Diagram 18 : 30M	11.36
58	UI characteristic 19 : 30M	11.37
59	Diagram 19 : 30M	11.38
60	UI characteristic 20 : 30M	11.39
61	Diagram 20 : 30M	11.40
62	UI characteristic 21 : 30M	11.41
63	Diagram 21 : 30M	11.42
64	UI characteristic 22 : 30M	11.43
65	Diagram 22 : 30M	11.44
66	UI characteristic 23 : 30M	11.45
67	Diagram 23 : 30M	11.46
68	UI characteristic 24 : 30M	11.47
69	Diagram 24 : 30M	11.48
70	UI characteristic 25 : 30M	11.49
71	Diagram 25 : 30M	11.50
72	UI characteristic 26 : 30M	11.51
73	Diagram 26 : 30M	11.52
74	UI characteristic 27 : 30M	11.53
75	Diagram 27 : 30M	11.54
76	UI characteristic 28 : 30M	11.55
77	Diagram 28 : 30M	11.56
78	UI characteristic 29 : 30M	11.57
79	Diagram 29 : 30M	11.58
80	UI characteristic 30 : 30M	11.59
81	Diagram 30 : 30M	11.60
82	UI characteristic 31 : 30M	11.61
83	Diagram 31 : 30M	11.62
84	UI characteristic 32 : 30M	11.63
85	Diagram 32 : 30M	11.64
86	UI characteristic 33 : 30M	11.65
87	Diagram 33 : 30M	11.66
88	UI characteristic 34 : 30M	11.67
89	Diagram 34 : 30M	11.68
90	UI characteristic 35 : 30M	11.69
91	Diagram 35 : 30M	11.70
92	UI characteristic 36 : 30M	11.71
93	Diagram 36 : 30M	11.72
94	UI characteristic 37 : 30M	11.73
95	Diagram 37 : 30M	11.74
96	UI characteristic 38 : 30M	11.75
97	Diagram 38 : 30M	11.76
98	UI characteristic 39 : 30M	11.77
99	Diagram 39 : 30M	11.78
100	UI characteristic 40 : 30M	11.79
101	Diagram 40 : 30M	11.80
102	UI characteristic 41 : 30M	11.81
103	Diagram 41 : 30M	11.82
104	UI characteristic 42 : 30M	11.83
105	Diagram 42 : 30M	11.84
106	UI characteristic 43 : 30M	11.85
107	Diagram 43 : 30M	11.86
108	UI characteristic 44 : 30M	11.87
109	Diagram 44 : 30M	11.88
110	UI characteristic 45 : 30M	11.89
111	Diagram 45 : 30M	11.90
112	UI characteristic 46 : 30M	11.91
113	Diagram 46 : 30M	11.92
114	UI characteristic 47 : 30M	11.93
115	Diagram 47 : 30M	11.94
116	UI characteristic 48 : 30M	11.95
117	Diagram 48 : 30M	11.96
118	UI characteristic 49 : 30M	11.97
119	Diagram 49 : 30M	11.98
120	UI characteristic 50 : 30M	11.99
121	Diagram 50 : 30M	12.00



**C. CONRADTY  
NÜRNBERG** GmbH & Co. KG

Post Box 1752  
D-8500 Nürnberg  
Telephone (09 11) 598-1  
Telegrams Ceconradty Nürnberg  
Telex 622 391 ccnbg d

## Table of Contents

	Page
1.	General . . . . . 3
2.	Design . . . . . 5
3.	Applications . . . . . 6
4.	Scopes of application . . . . . 6
5.	Type selection . . . . . 6
5.1.	Brief description of the standard
	product range . . . . . 7
5.2.	Selection criteria . . . . . 7
5.2.1.	Operating voltage . . . . . 8
5.2.2.	Energy absorption . . . . . 8
5.2.3.	Surge current . . . . . 8
5.2.4.	Protective level . . . . . 8
5.2.5.	Varistor, voltage . . . . . 8
5.2.6.	Capacitance . . . . . 8
5.2.7.	Power dissipation . . . . . 9
5.2.8.	Operating temperature range . . . . . 9
5.2.9.	Response time . . . . . 9
6.	Technical data . . . . . 9
6.1.	Table of varistors 35 to 170 VB . . . . . 10/11
6.2.	Table of varistors 200 to 540 VB . . . . . 12/13
7.	Characteristic curves and diagrams . . . . . 14
7.1.	U/I characteristic 1 : 6M . . . . . 14
7.2.	Diagram 1 : 6M . . . . . 15
7.3.	U/I characteristic 2 : 8M . . . . . 16
7.4.	Diagram 2 : 8M . . . . . 17
7.5.	U/I characteristic 3 : 12M . . . . . 18
7.6.	Diagram 3 : 12M . . . . . 19
7.7.	U/I characteristic 4 : 17M . . . . . 20
7.8.	Diagram 4 : 17M . . . . . 21
7.9.	U/I characteristic 5 : 24M . . . . . 22
7.10.	Diagram 5 : 24 . . . . . 23
8.	Application example . . . . . 24
9.	Questionnaire . . . . . 25
10.	Production range . . . . . 27/28

# 1. General

## Conradty - metal oxide - varistors CONOX<sup>®</sup>

CONOX<sup>®</sup> varistors are voltage-dependent resistors with symmetrical voltage and current characteristics which are therefore suitable for both DC and AC voltage applications.

These VDR (voltage-dependent) resistors are distinguished by a high voltage dependence; that is to say, the resistance decreases rapidly as the voltage rises.

This voltage dependence is represented by the nonlinearity exponent. The following relationship between the current  $I$  and voltage  $U$  applies for the ideal varistor:

$$U = B \cdot I^{1/n}$$

$B$  is the voltage at 1 A and  $n$  is the so-called exponent. If, as is usual, the varistor characteristic is entered into a double logarithmic  $U/I$  characteristic field,  $1/n$  is the steepness of the characteristic.  $n = 1$  applies to a voltage-independent, ohmic resistance. The voltage dependence increases as the value  $n$  increases. The exponent can be determined from two value pairs ( $U, I$ ).

$$n = \frac{\lg(I_1/I_2)}{\lg(U_1/U_2)}$$

$$n = \frac{1}{\lg(U(10\text{ mA}) / U(1\text{ mA}))}$$

The values  $I_1 = 10\text{ mA}$  and  $I_2 = 1\text{ mA}$  are mostly chosen in practice.

These result in

In the case of silicon carbide varistors (OCELIT<sup>®</sup>), the exponent is approximately 3 to 7 and, in the case of metal oxide varistors (CONOX<sup>®</sup>) it has been possible to increase this value to more than 25.

As the result of this, CONOX<sup>®</sup> varistors achieve the response steepness of Zener diodes, but with far higher energy absorption, surge current load and power dissipation values.

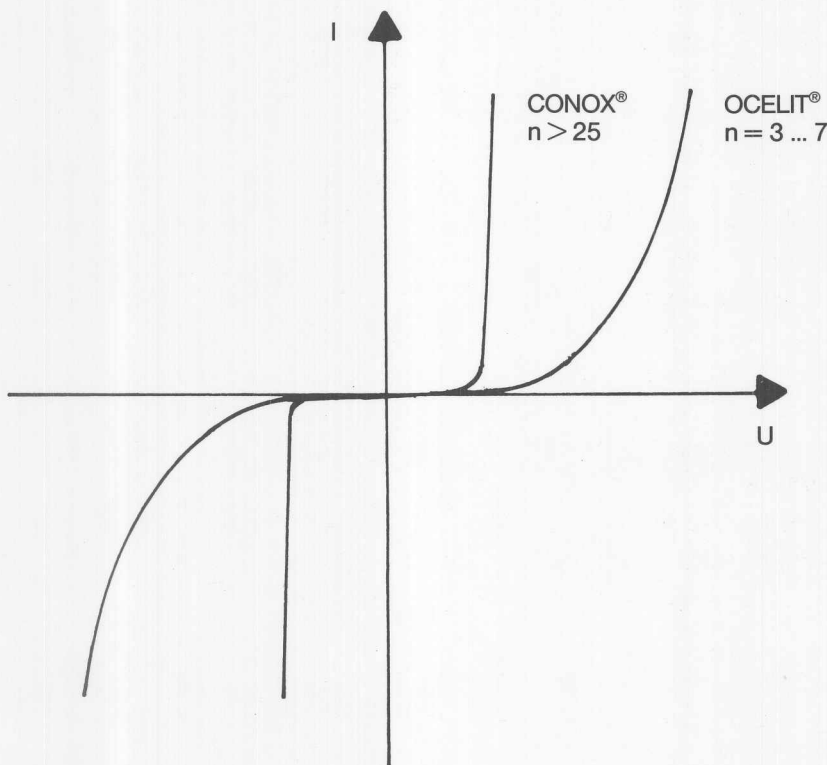

Figure 1:  $U/I$  characteristic of OCELIT<sup>®</sup>/  
CONOX<sup>®</sup> varistors



In conjunction with the short response time of  $< 25 \text{ ns}$  and the low leakage current of  $< 30 \mu\text{A}$ , these characteristics make the CONOX<sup>®</sup> varistor an ideal component for protecting electrical circuits against excess voltages.

Many years of experience in the development and production of our VDRs, i.e.:

- silicon carbide varistors (OCELIT<sup>®</sup>) since 1953
- metal oxide varistors (CONOX<sup>®</sup>) since 1974

manufactured in Germany in accordance with our own patents, guarantee optimum overvoltage protection and high reliability.

Our comprehensive standard range of products contains the optimum varistor for your applications.

Please ask for our other type lists for passive components:

- VDR-OCELIT<sup>®</sup> varistors  
(Voltage dependant resistors on a silicon carbide basis)
- OCELIT<sup>®</sup> resistors  
(Low-induction composite carbon resistors, voltage dependant, for high and low voltage applications)
- SILICO<sup>®</sup> resistors  
(Low-induction composite carbon resistors for high loads)

For special applications, and if corresponding quantities are ordered, we also develop and manufacture varistors in accordance with customers' requirements.

Our applications laboratory will be pleased to help you to select the correct varistor type for your circuits.

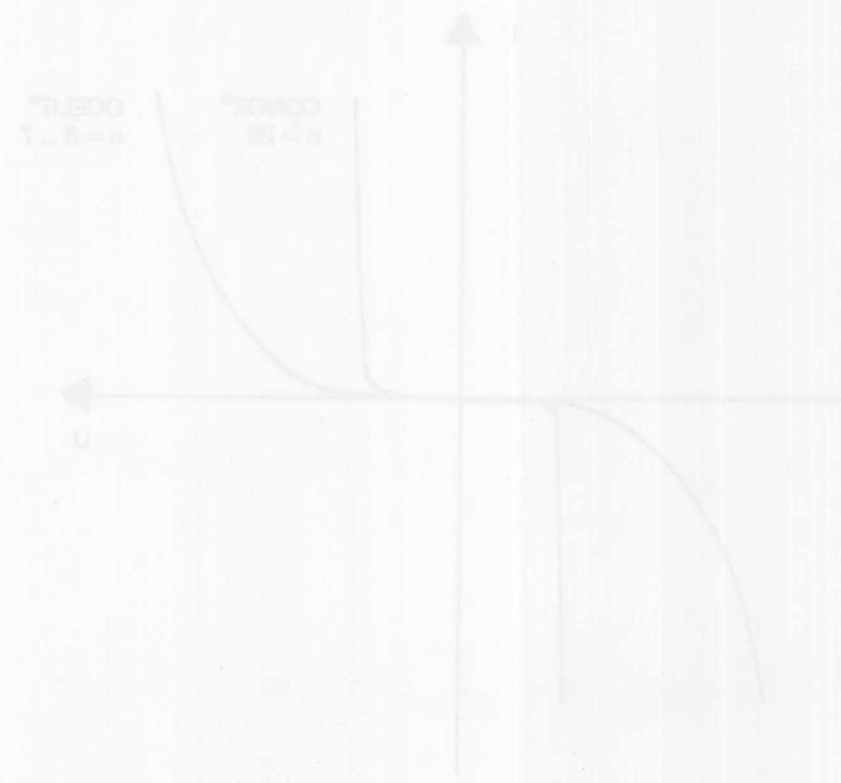

Figure 1: U-I characteristics of OCELIT<sup>®</sup> and CONOX<sup>®</sup> varistors

## 2. Design

CONOX<sup>®</sup> varistors are metal oxide varistors and consist of approximately 90 % zinc oxide as a ceramic base material and 10 % filler material for grain growth of the zinc oxide and formation of the junction between the ZnO grains.

Due to sintering of this mass, junctions comparable to those of Zener diodes are formed around the highly conductive ZnO grains. The response voltage of each ZnO grain is approximately 4 V. The varistor voltage is obtained by series connecting all ZnO grains in the current paths.

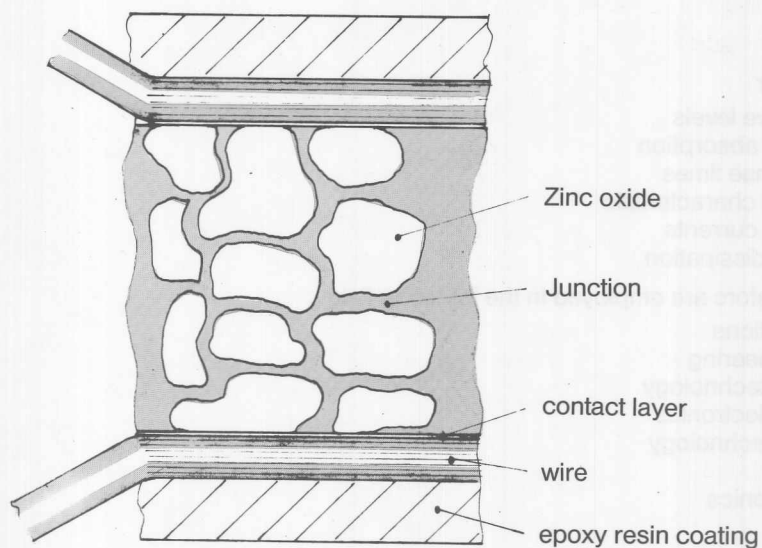

Figure 2: Design of the CONOX<sup>®</sup> varistor

In simplified terms, the following can be said about the metal oxide varistor:

- The thickness of the disk (with an identical grain size) is a measure of the varistor voltage.
- The diameter of the disk is a measure of the permissible surge current
- Both criteria together (thickness and diameter of the disk) are a measure of the energy absorption and power dissipation.

### 3. Applications

Overvoltage pulses are particularly dangerous to electronic circuits with semiconductor components. Overvoltages can destroy such components or can impair their functions. In electronic controllers, incorrect command sequences can result in grave consequences.

CONOX<sup>®</sup> varistors are a reliable and economical means of providing protection against internal overvoltages (that is to say, those which occur within the unit itself) and external overvoltages (that is to say, those which reach the unit from the outside).

CONOX<sup>®</sup> varistors are used for protection against:

- overvoltages in supply lines caused by lightning or stray inductive or capacitive interference.
- overvoltages in electrical components such as ICs, diodes, transistors, thyristors and triacs.
- burn off in the case of switching contacts with inductive loads.
- excessive switching-off voltages in the case of transformers, magnetic coils, motor and generator windings.

### 4. Scopes of application

Thanks of their

- low protective levels
- high energy absorption
- short response times
- symmetrical characteristic
- low leakage currents
- high power dissipation

CONOX<sup>®</sup> varistors are employed in the following fields:

- communications
- power engineering
- automation technology
- consumer electronics
- measuring technology
- telemetry
- office electronics

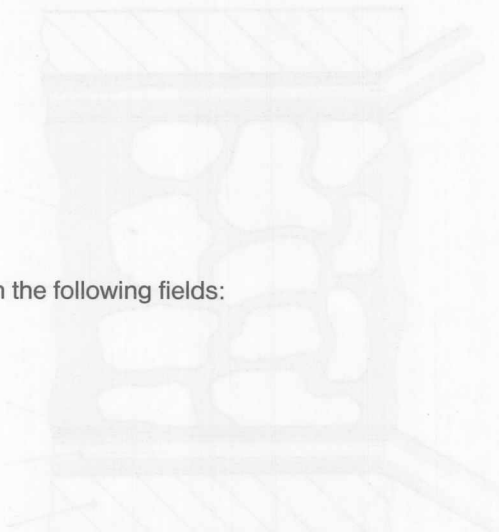

### 5. Type selection

CONOX<sup>®</sup> varistors are classified as follows:

example: CONOX<sup>®</sup> 12M 220 VB

CONOX<sup>®</sup> = **Con**radty metal **ox**ide varistor

12

= nominal diameter in mm

Disk types 6, 8, 12, 17 and 24 mm nominal diameter

Due to the epoxy resin coating, the installation diameter is greater than the nominal diameter.

M

= disk type with radial wire connections and epoxy resin coating.

Wire diameter 6 and 8M = 0.6 mm, 12, 17 and 24M = 0.8 mm.

220

= operating voltage 220 V<sub>rms</sub>

V

= varistor

B

= varistor voltage tolerance class B = ± 10 %

Other tolerance ranges are possible if corresponding quantities are ordered.

## 5.1 Brief description of the standard product range

- Operating voltage	35 to 540 V <sub>rms</sub>
- Installation diameter	7 to 25 mm
- Exponent	> 25
- Surge currents	up to 4000 A
- Energy absorption	up to 200 J
- Continuous power dissipation	up to 0.8 W
- Response time	≤ 50 ns
- Operating temperature at zero load	-25 to +115°C
- Operating temperature at full load	-25 to + 70°C
- Temperature coefficient at 1 mA between +25° and +85°C	-0.05 %/K
- Capacitance	80 to 3000 pF
- Standard range	90 types

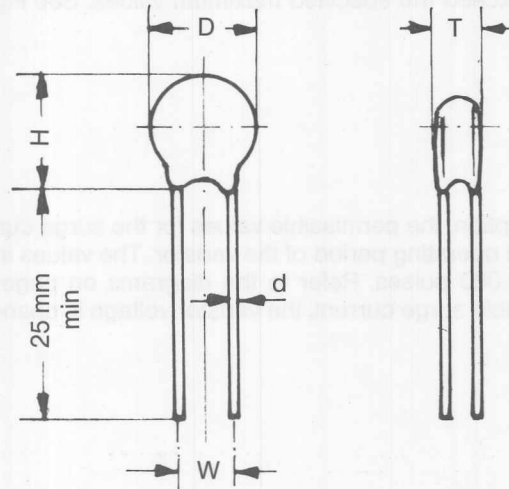

Figure 3: Mechanical dimensions

## 5.2 Selection criteria

The varistor types are listed in the following tables according to operating voltages. Several types (up to 5) are available for each operating voltage and these differ with respect to their sizes and capabilities.

In order to select the best varistor for a specific application, it is best to proceed on the basis of the operating voltage continuously applied to the varistor. The operating voltage recommended for each varistor is listed in the table for AC voltages. The maximally permissible AC voltage is also listed. Under no circumstances may this be exceeded. The specified maximum DC voltage value applies to a voltage without an AC voltage component ("hum"). If an AC voltage component is present, this value must be reduced accordingly.

Corresponding to the intended application, a class of varistor is selected in such a manner that the maximally possible operating voltage lies below the maximum value of the table. On the other hand, the chosen varistor should have as low a voltage as possible in order to achieve good limiting of overvoltage pulses.

Of the types available for one operating voltage, further selection is based on the following criteria:

- pulse current
- pulse energy
- power dissipation

The pulse current, pulse energy and power dissipation must lie within the threshold values specified in the table. The maximum current and energy pulses depend on the number of pulses during the entire operating time of the varistor and on the pulse waveform. The values specified in the table apply to a standard wave 8/20 μs. For other pulse lengths, refer to the diagrams on pages 11 to 19 for the maximally permissible current.

For pulses with the energy E in the time interval t the power dissipation is calculated as follows:

$$P = \frac{E}{t}$$

## 5.2.1 Operating voltage

The operating voltage  $U_{\text{rms}}$  is part of the varistor designation. The maximally permissible rms operating voltage is approximately 10 % higher. Under no circumstances may this be exceeded. The maximally permissible DC voltage value ( $U_{\text{max}} \approx 1.3 \times U_{\text{rms max}}$ ) applies to a voltage with no hum. If the voltage has a hum component, this value must be reduced accordingly, as well as at ambient temperatures above +70°C (see Figure 4).

## 5.2.2 Energy absorption

The permissible energy absorption values depend on the length and number of pulses during the entire operating period of the varistor as well as on the ambient temperature.

The values for the standard wave 8/20  $\mu\text{s}$  are given in the table. The permissible energy value must be determined from the diagrams on pages 11 to 19 if the pulse length differs. The permissible energy decreases as the pulse duration increases. The values for 1, 100 and 10.000 pulses are given in the table. Refer to the diagrams on pages 11 to 19 for further values. The energy  $E$  is given by  $E = U \cdot I \cdot t$ . The change in the varistor voltage is less than 10 % at loads which should not exceed the specified maximum values. See Figure 4 for ambient temperatures above +70°C.

## 5.2.3 Surge current

As in the case of the energy absorption, the permissible values for the surge current  $I$  depend on the length and number of pulses during the entire operating period of the varistor. The values in the table apply to the standard wave 8/20  $\mu\text{s}$  and 1, 100 and 10.000 pulses. Refer to the diagrams on pages 11 to 19 for further values. If loaded with the maximally permissible surge current, the varistor voltage is changed by less than 10 %.

## 5.2.4 Protective level

The protective level is the maximally permissible voltage at a specific current, in this case, at the maximum current for 10.000 pulses. Refer to the characteristic curves for further voltage values.

## 5.2.5 Varistor voltage

The varistor voltage is measured with an impressed current of 1 mA and serves to characterize each varistor type. CONOX® varistors are usually delivered with a varistor voltage tolerance of  $\pm 10 \%$ .

## 5.2.6 Capacitance

Only typical values are specified for the capacitance. These apply to a frequency of 1 kHz. The capacitance drops somewhat at higher frequencies.

## 5.2.7 Power dissipation

The power dissipation value applies for a temperature range of  $-25^{\circ}\text{C}$  to  $+70^{\circ}\text{C}$ . Refer to Figure 4 for ambient temperatures which do not lie within this range.

## 5.2.8 Operating temperature range

The specified energy absorption, power dissipation and operating voltage values apply to a range of  $-25^{\circ}\text{C}$  to  $+70^{\circ}\text{C}$ . At higher temperatures the values must be reduced in accordance with the curve.

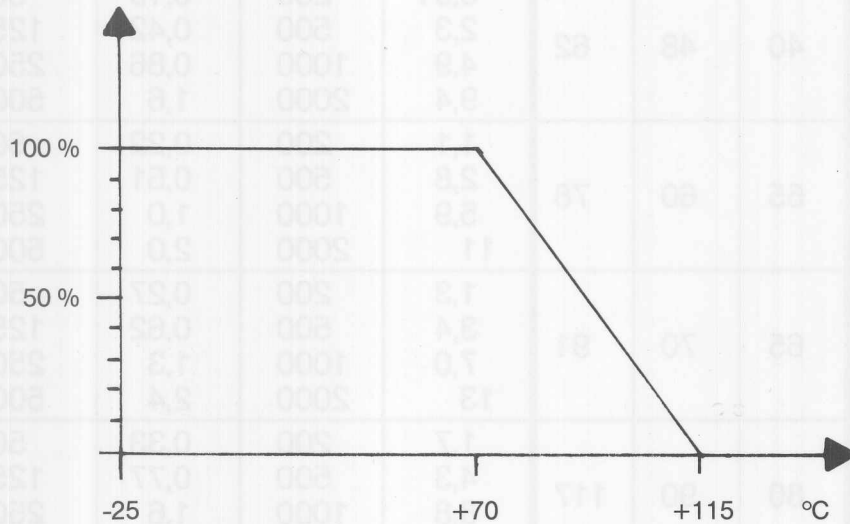

Figure 4: Dependence of the permissible power dissipation, energy and operating voltage on the ambient temperature

## 5.2.9 Response time

The response time of the varistor is essentially defined by the connection inductance. In order to achieve a short response time ( $\leq 50$  ns), the varistor must be installed with short connections for low inductance.

# 6. Technical data

The maximum values given in the following tables are absolute threshold values.

The maximally permissible load of a varistor has been reached when one of the specified maximum values is exceeded, even if the other threshold values have not yet been reached.



## 6.1 CONOX<sup>®</sup> varistors 35 to 170 VB

Type	Operating voltage			One surge 8/20 $\mu$ s max.		10 <sup>2</sup> surges 8/20 $\mu$ s max.		10 <sup>4</sup> surge
	U <sub>ms</sub> V	max. U <sub>rms</sub> V	max. U= V	energy J	current A	energy J	current A	energy J
6M 35VB 8M 35VB 12M 35VB 17M 35VB	35	42	54	0,75	200	0,16	50	0,05
1,9				500	0,35	125	0,13	
4,0				1000	0,71	250	0,23	
7,9				2000	1,3	500	0,36	
6M 40VB 8M 40VB 12M 40VB 17M 40VB	40	48	62	0,91	200	0,19	50	0,06
2,3				500	0,42	125	0,15	
4,9				1000	0,86	250	0,29	
9,4				2000	1,6	500	0,44	
6M 55VB 8M 55VB 12M 55VB 17M 55VB	55	60	78	1,1	200	0,22	50	0,07
2,8				500	0,51	125	0,19	
5,9				1000	1,0	250	0,36	
11				2000	2,0	500	0,54	
6M 65VB 8M 65VB 12M 65VB 17M 65VB	65	70	91	1,3	200	0,27	50	0,09
3,4				500	0,62	125	0,22	
7,0				1000	1,3	250	0,43	
13				2000	2,4	500	0,64	
6M 80VB 8M 80VB 12M 80VB 17M 80VB	80	90	117	1,7	200	0,33	50	0,11
4,3				500	0,77	125	0,28	
8,8				1000	1,6	250	0,55	
17				2000	3,1	500	0,80	
6M 90VB 8M 90VB 12M 90VB 17M 90VB 24M 90VB	90	105	137	2,0	200	0,39	50	0,13
5,2				500	0,93	125	0,33	
10				1000	1,9	250	0,66	
20				2000	3,7	500	0,97	
39				4000	7,6	1000	1,2	
6M 110VB 8M 110VB 12M 110VB 17M 110VB 24M 110VB	110	130	169	2,4	200	0,48	50	0,16
6,4				500	1,1	125	0,41	
13				1000	2,3	250	0,81	
24				2000	4,6	500	1,2	
48				4000	9,2	1000	1,5	
6M 130VB 8M 130VB 12M 130VB 17M 130VB 24M 130VB	130	140	182	2,7	200	0,52	50	0,18
7,0				500	1,2	125	0,44	
14				1000	2,5	250	0,89	
26				2000	5,0	500	1,3	
53				4000	10	1000	1,6	
6M 140VB 8M 140VB 12M 140VB 17M 140VB 24M 140VB	140	160	208	3,0	200	0,58	50	0,20
7,9				500	1,4	125	0,50	
16				1000	2,8	250	1,0	
29				2000	5,7	500	1,5	
60				4000	11	1000	1,8	
6M 170VB 8M 170VB 12M 170VB 17M 170VB 24M 170VB	170	195	253	3,7	200	0,71	50	0,25
9,6				500	1,7	125	0,61	
19				1000	3,5	250	1,2	
36				2000	6,9	500	1,8	
75				4000	14	1000	2,2	

3/20 $\mu$ s max. current A	Protective level at $10^4$ surges V	Varistor voltage at 1 mA $\pm$ 10 % V	C typ. pF	Power dissipation W	Dimensions in mm				
					D max.	H max.	T max.	w $\pm$ 1	d
20	130	68	300	0,1	7	8	3	5	0,6
50	140		740	0,2	9	11	3	5	0,6
100	135		1900	0,4	15	17	4	7,5	0,8
150	135		4700	0,6	18	21	4	7,5	0,8
20	155	82	250	0,1	7	8	3	5	0,6
50	165		620	0,2	9	11	3	5	0,6
100	160		1600	0,4	15	17	4	7,5	0,8
150	160		3900	0,6	18	21	4	7,5	0,8
20	190	100	200	0,1	7	8	3	5	0,6
50	200		510	0,2	9	11	4	5	0,6
100	190		1300	0,4	15	17	4	7,5	0,8
150	190		3200	0,6	18	21	4	7,5	0,8
20	230	120	170	0,1	7	8	4	5	0,6
50	240		430	0,2	9	11	4	5	0,6
100	230		1100	0,4	15	17	4	7,5	0,8
150	230		2600	0,6	18	21	4	7,5	0,8
20	285	150	140	0,1	7	8	4	5	0,6
50	300		350	0,2	9	11	4	5	0,6
100	285		890	0,4	15	17	4	7,5	0,8
150	280		2100	0,6	18	21	4	7,5	0,8
20	340	180	120	0,1	7	8	4	5	0,6
50	360		300	0,2	9	11	4	5	0,6
100	340		740	0,4	15	17	4	7,5	0,8
150	335		1800	0,6	18	21	4	7,5	0,8
200	345		2900	0,8	25	28	4	7,5	0,8
20	380	220	100	0,1	7	8	4	5	0,6
50	400		250	0,2	9	11	4	5	0,6
100	375		610	0,4	15	18	4	7,5	0,8
150	370		1400	0,6	18	21	4	7,5	0,8
200	380		2400	0,8	25	28	4	7,5	0,8
20	455	240	90	0,1	7	8	4	5	0,6
50	480		230	0,2	9	11	4	5	0,6
100	445		560	0,4	15	18	4	7,5	0,8
150	440		1300	0,6	18	21	4	7,5	0,8
200	455		2200	0,8	25	28	4	7,5	0,8
20	510	270	80	0,1	7	8	4	5	0,6
50	540		210	0,2	9	11	4	5	0,6
100	500		500	0,4	15	18	4	7,5	0,8
150	495		1200	0,6	18	21	5	7,5	0,8
200	505		2000	0,8	25	28	5	7,5	0,8
20	625	330	70	0,1	7	8	4	5	0,6
50	660		180	0,2	9	11	4	5	0,6
100	610		410	0,4	15	18	5	7,5	0,8
150	605		910	0,6	18	21	5	7,5	0,8
200	615		1700	0,8	25	28	5	7,5	0,8

## 6.2 CONOX<sup>®</sup> varistors 200 to 540 VB

Type	Operating voltage			One surge 8/20 $\mu$ s max.		10 <sup>2</sup> surges 8/20 $\mu$ s max.		10 <sup>4</sup> surge max.
	U <sub>ms</sub> V	max. U <sub>rms</sub> V	max. U = V	energy J	current A	energy J	current A	energy J
6M 200VB	200	230	300	4,3	200	0,83	50	0,29
8M 200VB				11	500	2,0	125	0,72
12M 200VB				23	1000	4,1	250	1,5
17M 200VB				42	2000	8,2	500	2,1
24M 200VB				89	4000	16	1000	2,6
6M 220VB	220	250	325	4,7	200	0,90	50	0,31
8M 220VB				12	500	2,2	125	0,78
12M 220VB				24	1000	4,4	250	1,6
17M 220VB				45	2000	8,9	500	2,3
24M 220VB				96	4000	18	1000	2,8
6M 240VB	240	265	345	5,0	200	0,96	50	0,34
8M 240VB				13	500	2,3	125	0,83
12M 240VB				26	1000	4,8	250	1,7
17M 240VB				48	2000	9,5	500	2,4
24M 240VB				105	4000	19	1000	3,0
6M 250VB	250	280	364	5,2	200	1,0	50	0,35
8M 250VB				14	500	2,4	125	0,87
12M 250VB				27	1000	5,0	250	1,8
17M 250VB				51	2000	9,9	500	2,5
24M 250VB				110	4000	20	1000	3,2
8M 300VB	300	330	429	16	500	2,9	125	1,0
12M 300VB				32	1000	5,9	250	2,1
17M 300VB				60	2000	12	500	3,0
24M 300VB				130	4000	23	1000	3,8
8M 340VB	340	380	494	19	500	3,3	125	1,2
12M 340VB				37	1000	6,8	250	2,4
17M 340VB				69	2000	14	500	3,4
24M 340VB				150	4000	27	1000	4,3
8M 380VB	380	420	546	21	500	3,7	125	1,3
12M 380VB				41	1000	7,5	250	2,7
17M 380VB				76	2000	15	500	3,8
24M 380VB				165	4000	30	1000	4,8
8M 420VB	420	460	598	23	500	4,0	125	1,4
12M 420VB				45	1000	8,3	250	2,9
17M 420VB				83	2000	17	500	4,2
24M 420VB				180	4000	32	1000	5,3
8M 440VB	440	490	637	24	500	4,2	125	1,5
12M 440VB				47	1000	8,7	250	3,1
17M 440VB				88	2000	17	500	4,4
24M 440VB				190	4000	34	1000	5,6
8M 540VB	540	600	780	29	500	5,2	125	1,8
12M 540VB				58	1000	11	250	3,8
17M 540VB				110	2000	21	500	5,4
24M 540VB				235	4000	42	1000	6,8

7. Characteristic curves and diagrams for COVIX varistors  
 The characteristic curves 1 to 5 show the maximum possible voltage at a specific current. The typical voltage  
 values are in Table 2.5.

I/20 $\mu$ s max. current A	Protective level at 10 <sup>4</sup> surges V	Varistor voltage at 1 mA $\pm$ 10 % V	C typ. pF	Power dissipation W	Dimensions in mm				
					D max.	H max.	T max.	w $\pm$ 1	d
20	740	390	60	0,1	7	8	4	5	0,6
50	780		160	0,2	9	12	5	5	0,6
100	720		360	0,4	15	18	5	7,5	0,8
150	710		820	0,6	18	21	5	7,5	0,8
200	725		1400	0,8	25	28	5	7,5	0,8
20	795	420	55	0,1	7	8	5	5	0,6
50	840		150	0,2	9	12	5	5	0,6
100	775		330	0,4	15	19	5	7,5	0,8
150	765		760	0,6	18	22	5	7,5	0,8
200	780		1300	0,8	25	28	5	7,5	0,8
20	850	450	50	0,1	7	8	5	5	0,6
50	900		140	0,2	9	12	5	5	0,6
100	830		310	0,4	15	19	5	7,5	0,8
150	820		710	0,6	18	22	5	7,5	0,8
200	835		1300	0,8	25	29	6	7,5	0,8
20	890	470	50	0,1	7	8	5	5	0,6
50	940		140	0,2	9	12	5	5	0,6
100	865		300	0,4	15	19	5	7,5	0,8
150	855		680	0,6	18	22	5	7,5	0,8
200	870		1200	0,8	25	29	6	7,5	0,8
50	1115	560	120	0,2	9	13	5	5	0,6
100	1030		250	0,4	15	19	6	7,5	0,8
150	1015		570	0,6	18	22	6	7,5	0,8
200	1035		1100	0,8	25	29	6	7,5	0,8
50	1275	640	110	0,2	9	13	6	5	0,6
100	1175		230	0,4	15	19	6	7,5	0,8
150	1155		500	0,6	18	22	6	7,5	0,8
200	1180		940	0,8	25	29	6	7,5	0,8
50	1415	710	100	0,2	9	13	6	5	0,6
100	1305		210	0,4	15	19	6	7,5	0,8
150	1280		450	0,6	18	22	6	7,5	0,8
200	1305		860	0,8	25	29	6	7,5	0,8
50	1555	780	95	0,2	9	13	6	5	0,6
100	1430		190	0,4	15	19	7	7,5	0,8
150	1405		410	0,6	18	23	7	7,5	0,8
200	1430		800	0,8	25	29	7	7,5	0,8
50	1630	820	90	0,2	9	13	7	5	0,6
100	1505		180	0,4	15	19	7	7,5	0,8
150	1480		400	0,6	18	23	7	7,5	0,8
200	1505		770	0,8	25	29	8	7,5	0,8
50	1990	1000	80	0,2	9	13	7	5	0,6
100	1835		150	0,4	15	19	7	7,5	0,8
150	1800		320	0,6	18	23	7	7,5	0,8
200	1830		660	0,8	25	29	8	7,5	0,8



## 7. Characteristic curves and diagrams for CONOX<sup>®</sup> varistors

### Characteristics:

The characteristic curves 1 to 5 show the maximum possible voltage at a specific current. The typical voltage values thus lie below this.

### Diagrams:

If the permissible surge current and permissible energy absorption of a varistor cannot be found in the table because the pulse lengths and number of surges do not agree with the data in the table, please refer to the values in diagrams 1 to 5.

### 7.1 U/I characteristic 1: 6M

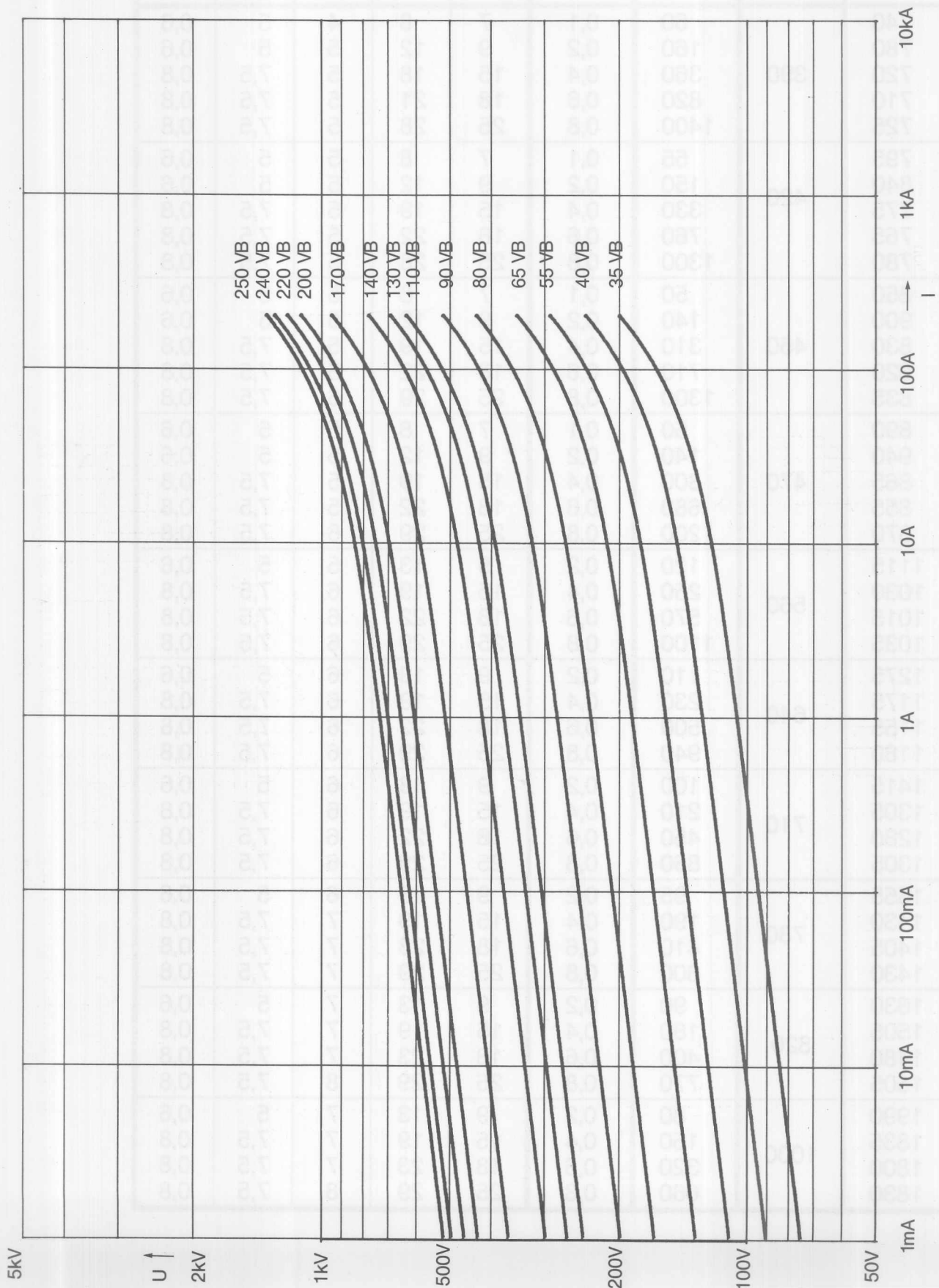

# 7.2 Diagram 1: Types Series 6M

Permissible surge current as a function of the number of surges and the pulse length.

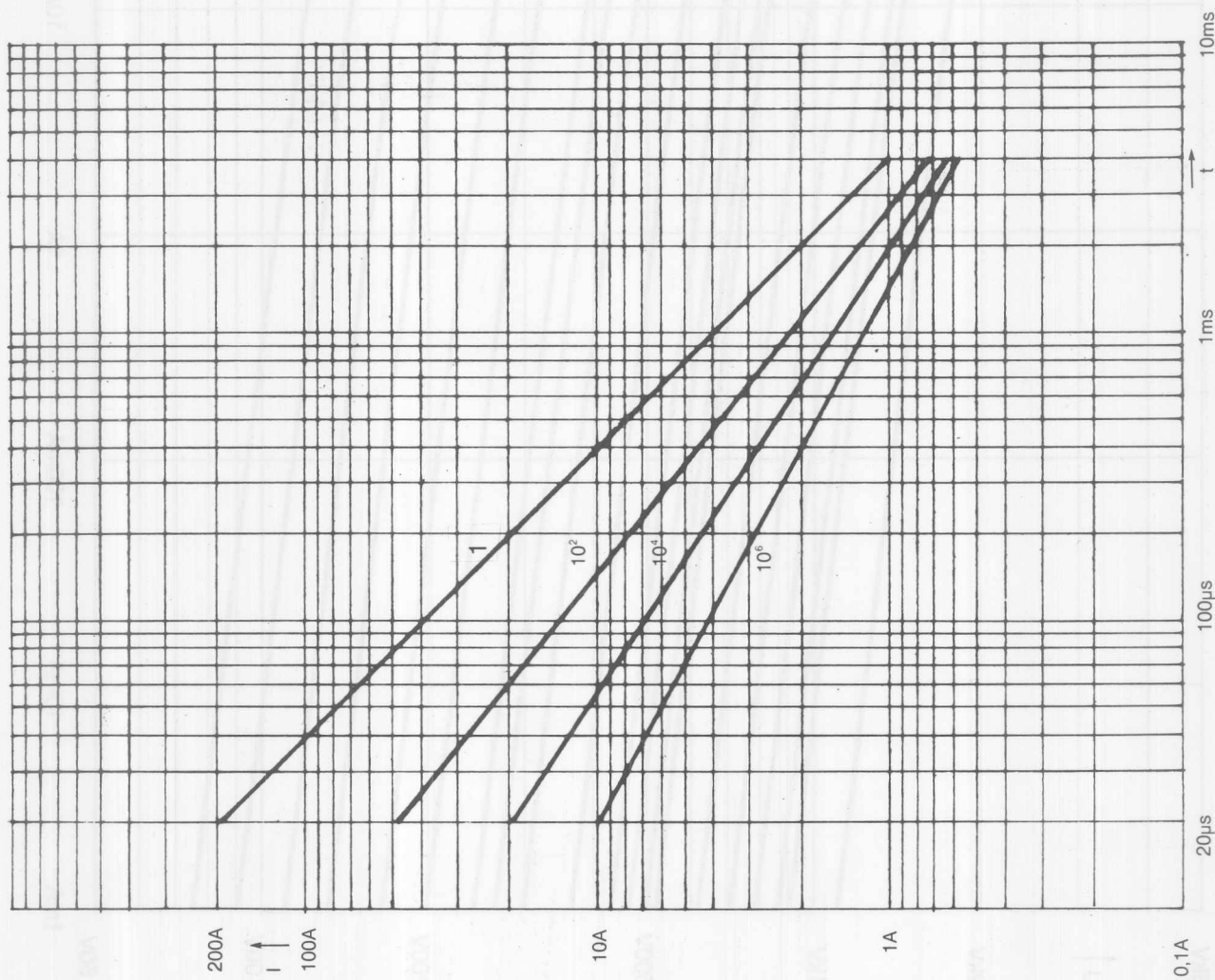



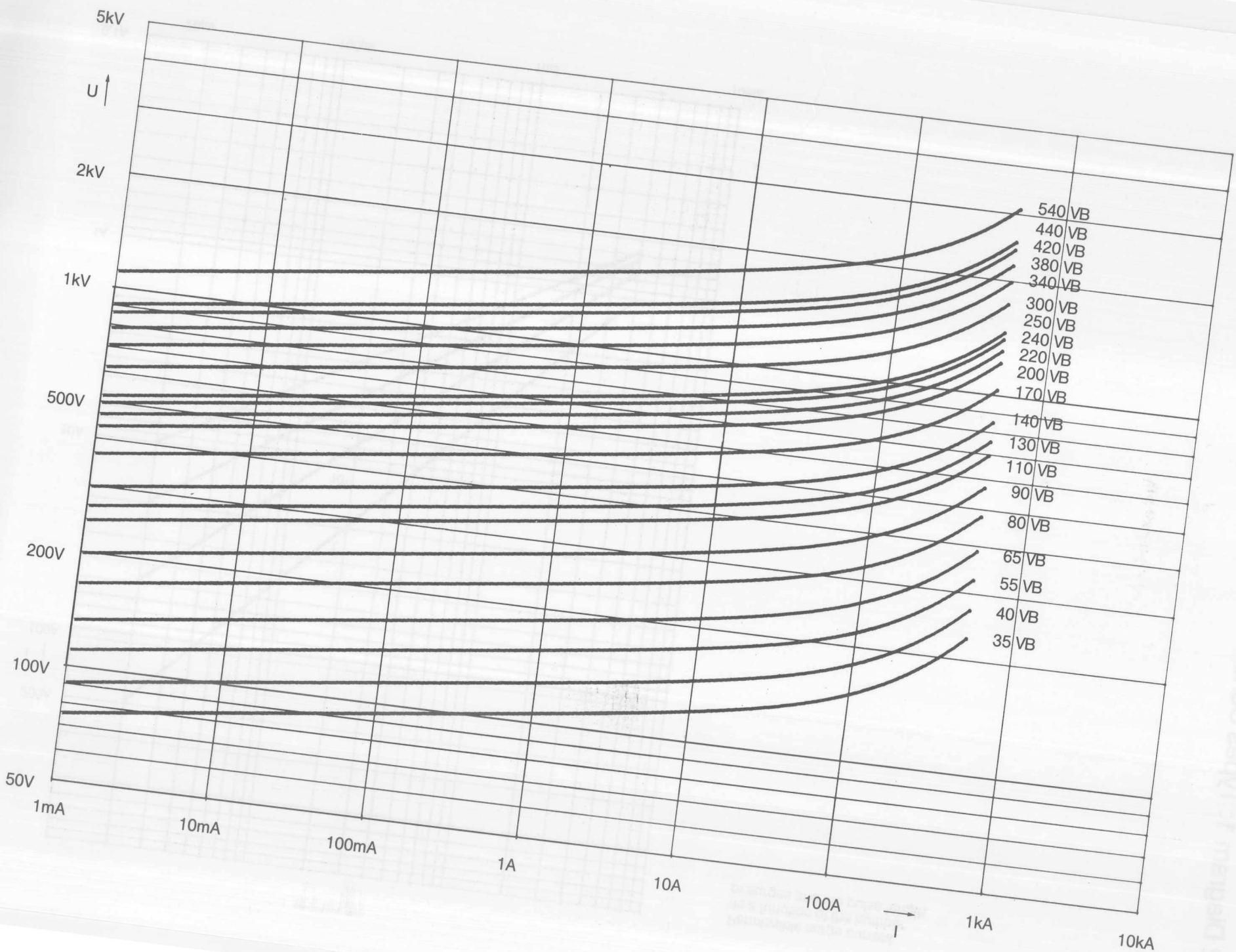

7.3 U/I characteristic 2/ 8M

MA series energy storage capacitor S.T.

# 7.4 Diagram 2: Type Series 8M

Permissible surge current as a function of the number of surge and the pulse length

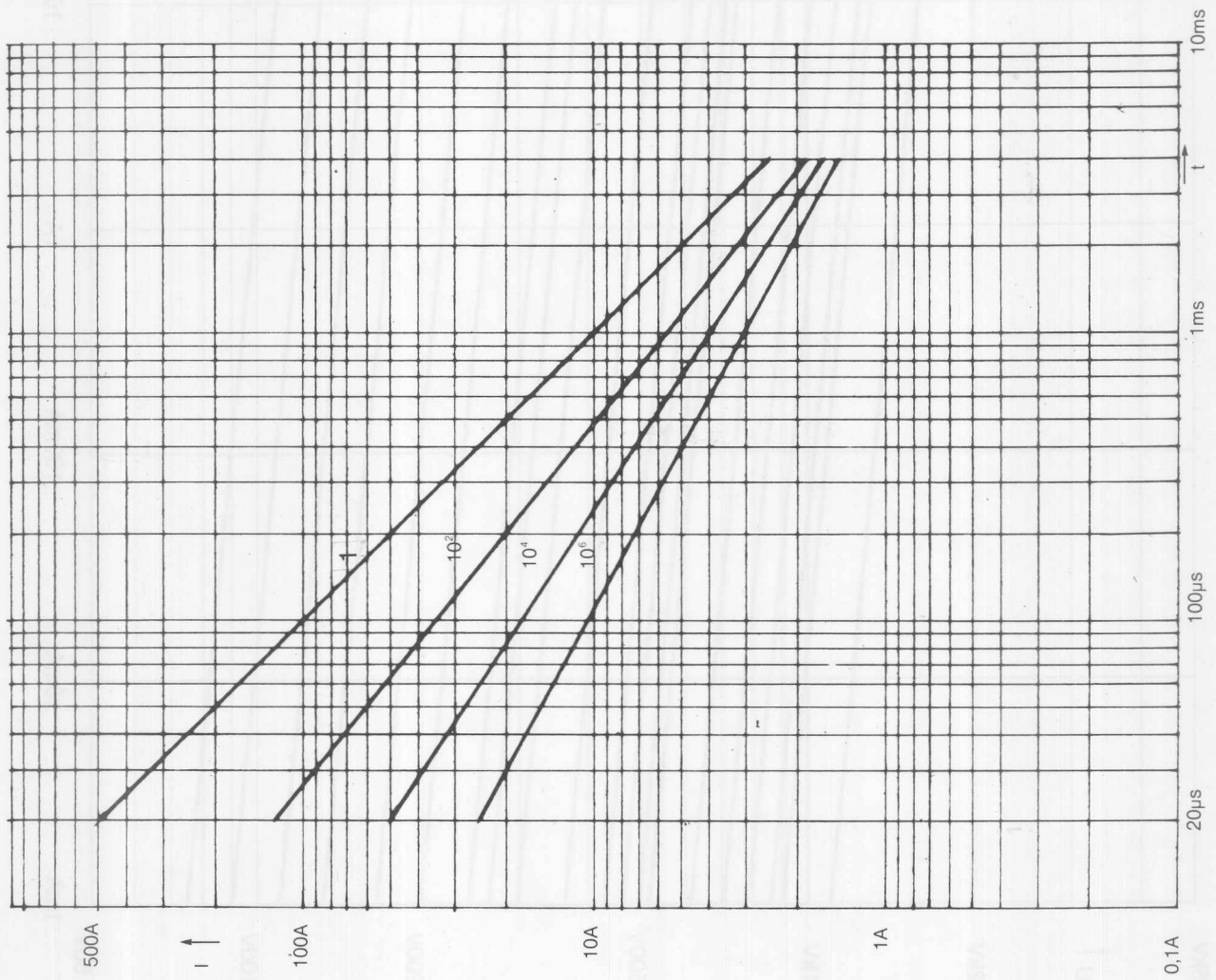

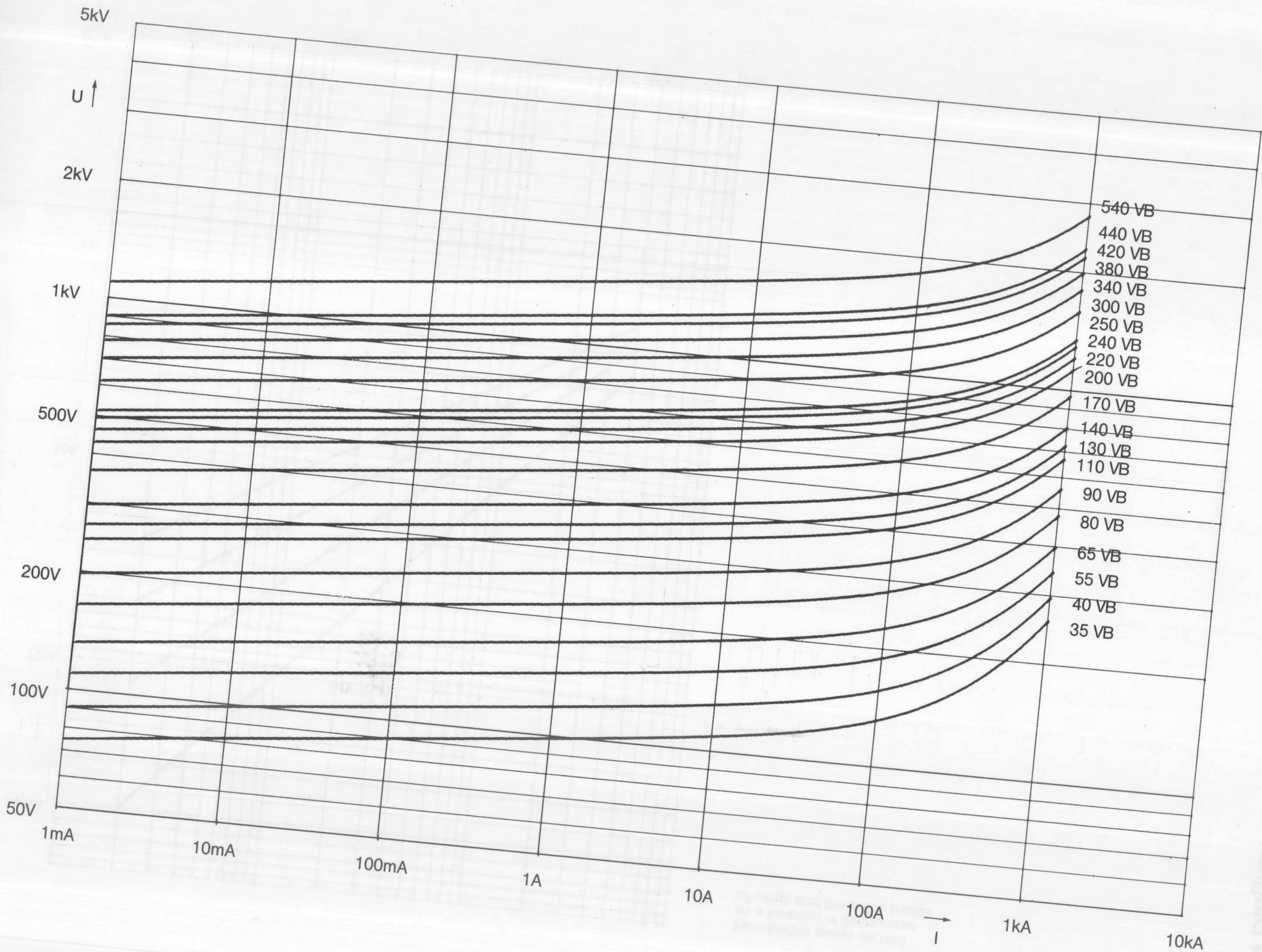

7.5 U/I characteristic 3: 12M

MB asher 2 qvT S rnsrD A Y

# 7.6 Diagram 3: Type Series 12M

Permissible surge current as a function of the number of surges and the pulse length

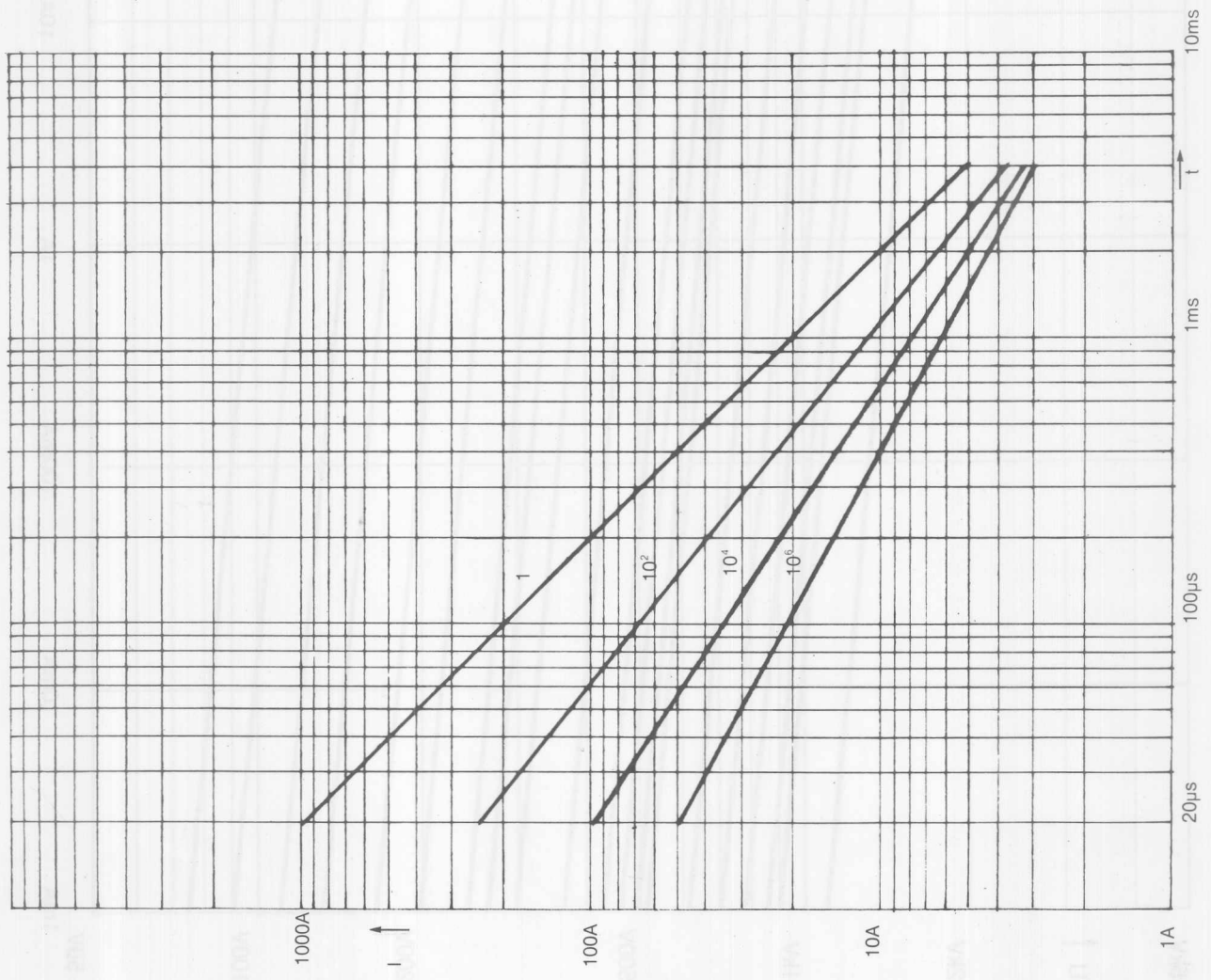

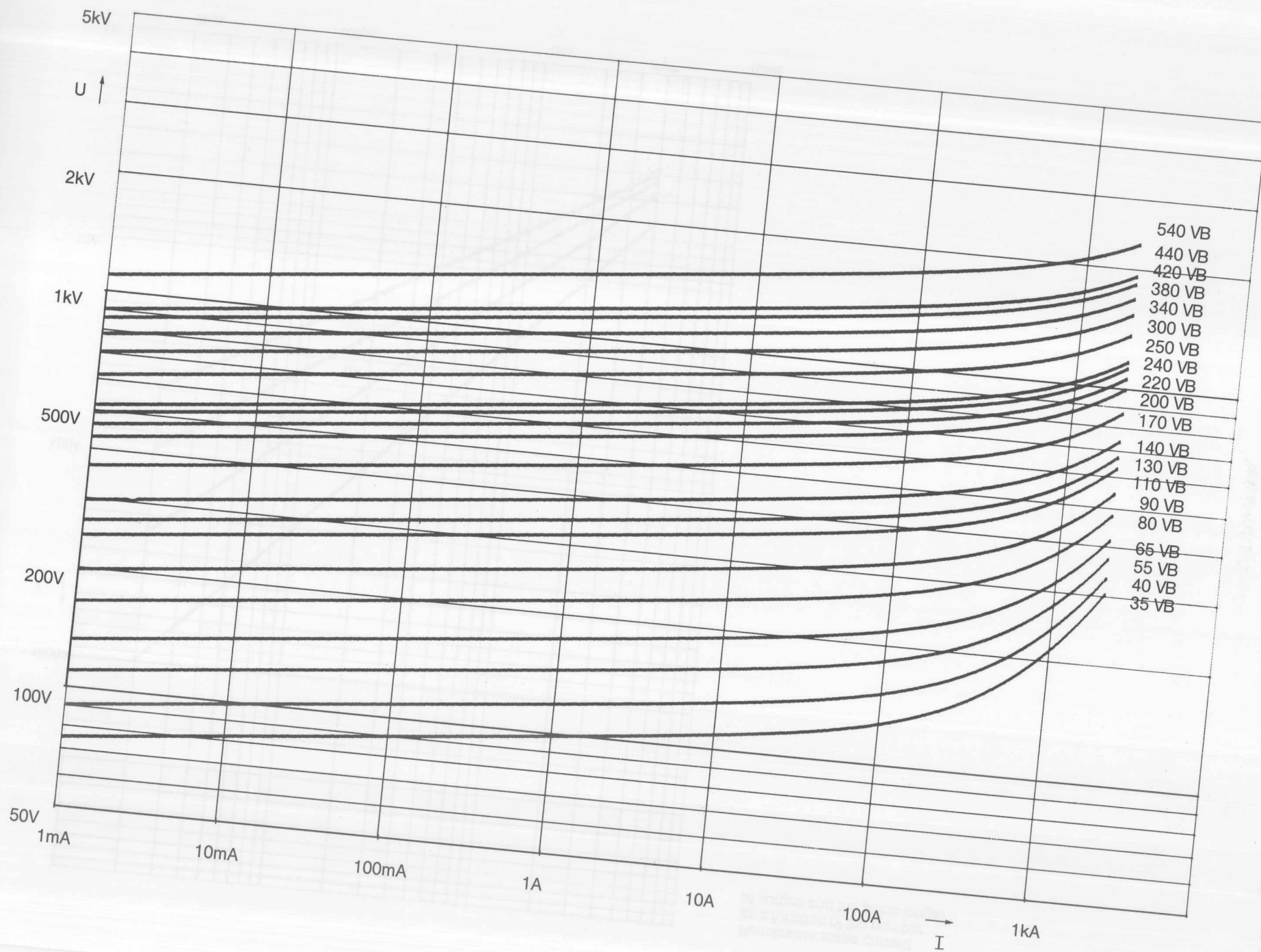

7.7 U/I characteristic 4: 17M



# 7.8 Diagram 4: Type Series 17M

Permissible surge current  
as a function of the number  
of surges and the pulse length

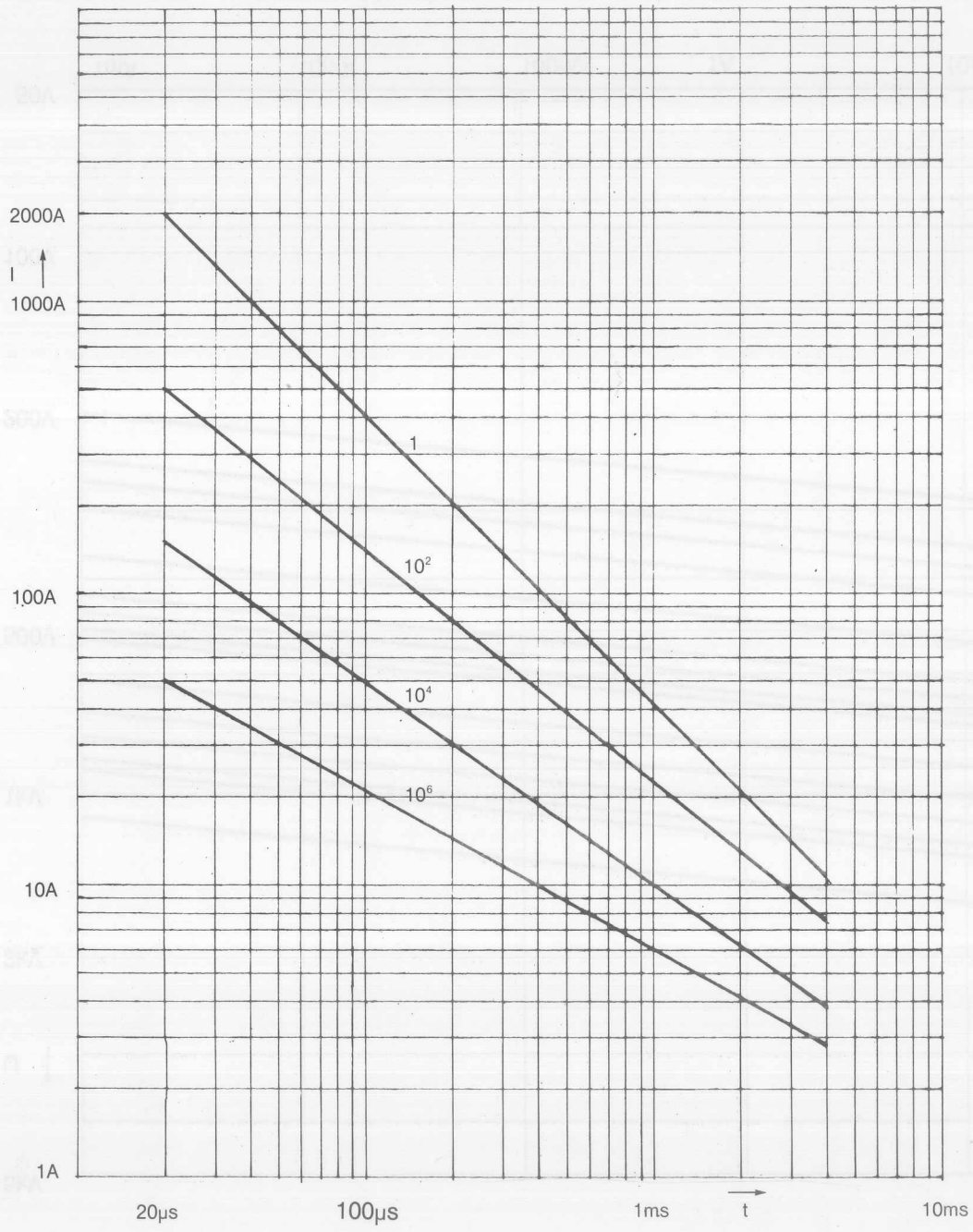



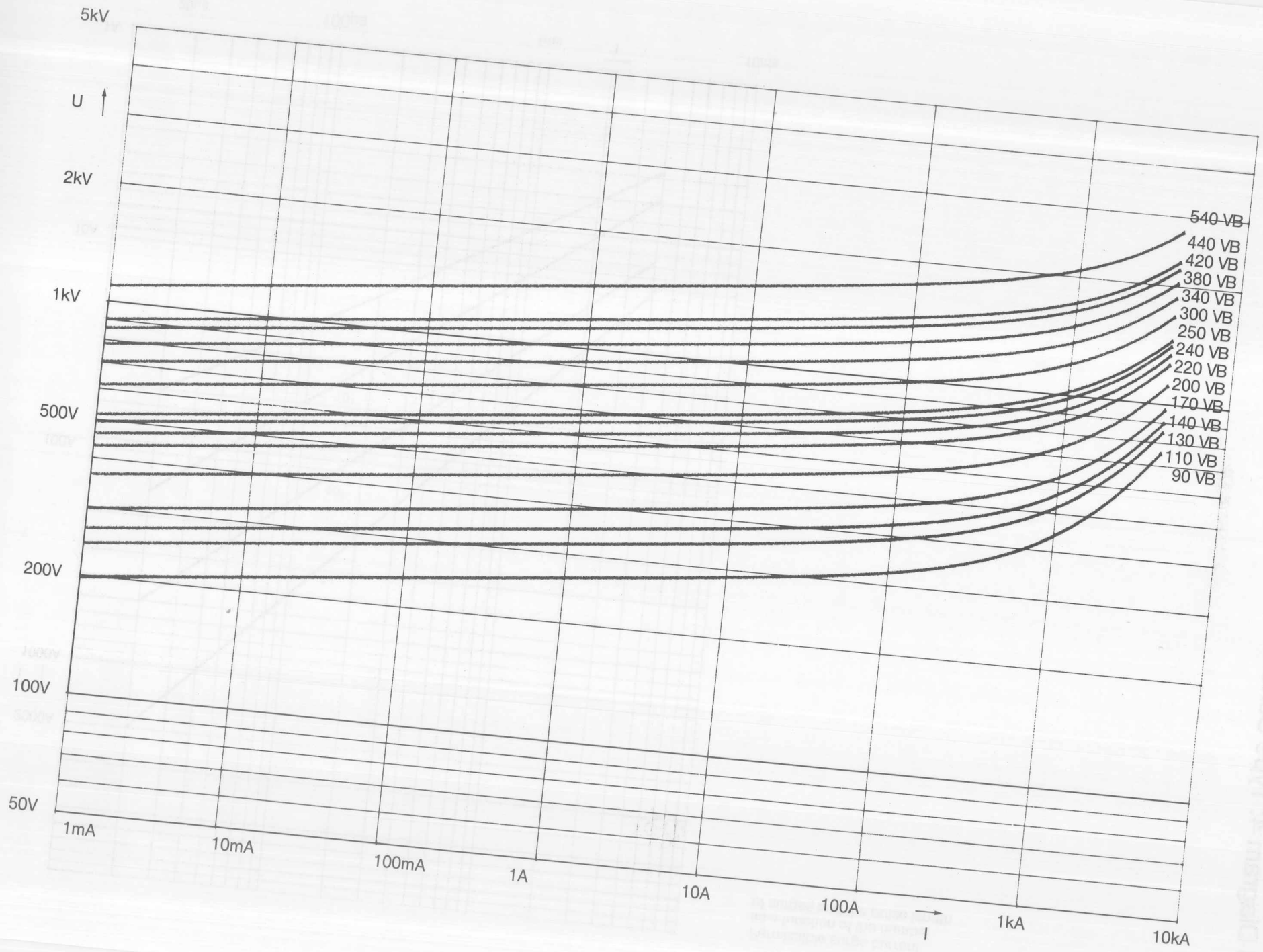

7.9 U/I characteristic 5: 24M

# 7.10 Diagram 5: Type Series 24M

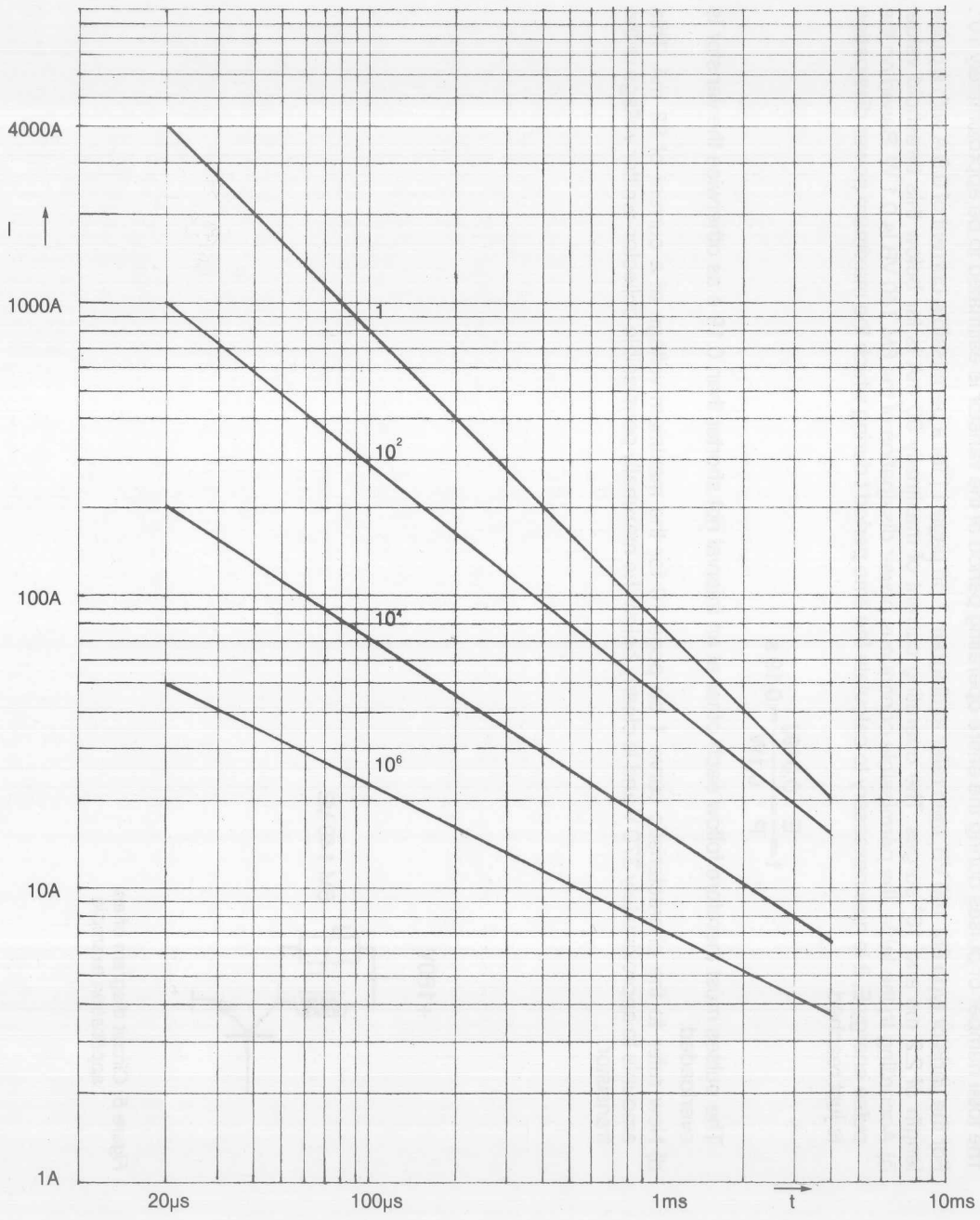

Permissible surge current as a function of the number of surges and the pulse length

## 8. Application example

A lifting magnet is driven by a switching transistor. During switching off of the magnet, an overvoltage pulse occurs which destroys the transistor. A varistor must be used to limit the pulse to a safe voltage value.

The data of the lifting magnet and circuit are:

Operating voltage:	180 V DC $\pm$ 10 %, smoothed, without hum component
Operating current:	80 mA
Ohmic resistance R:	2250 $\Omega$
Inductance L:	5 H
Maximum collector-emitter voltage of the transistor:	500 V

a) The maximum operating voltage is 198 V and therefore a varistor in the voltage class 140 VB with a maximum DC voltage of 208 V can be considered.

b) The suitable varistor is found on the basis of the energy and current load: A maximum current of 80 mA + 10 % = 88 mA flows through the varistor. The energy of the pulse amounts to

$$E = \frac{1}{2} L I^2 = \frac{1}{2} 5 \text{ H} \cdot (0,088 \text{ A})^2 = 0,019 \text{ J}$$

The pulse length lies within the order of magnitude the time constant  $\tau$

$$\tau = \frac{L}{R} = 2,2 \text{ ms}$$

The total number of pulses during the entire operating period of the varistor is estimated to be approximately  $10^4$ .

For the varistor type 6M 140 VB, then refer to diagram 1 on page 11 for a permissible current of 0.9 A with a pulse length of 2.2 ms and  $10^4$  surges. The operating current of maximally 80 mA is far below this threshold value.

c) According to the table, the permissible continuous power dissipation of the 6M 140 VB is 0.1 W. Based on the pulse energy E, it is now necessary to calculate the time period t during which the maximum power dissipation is just reached.

$$t = \frac{E}{P} = \frac{0,019 \text{ J}}{0,1 \text{ W}} = 0,19 \text{ s}$$

The pulses must therefore follow each other at an interval not shorter than 0.19 s as otherwise the varistor is overloaded.

d) Now refer to the characteristic curve 1 on page 10 for the maximum voltage at a current of 88 mA. This amounts to approximately 370 V and is clearly below the maximally permissible collector-emitter voltage of the transistor.

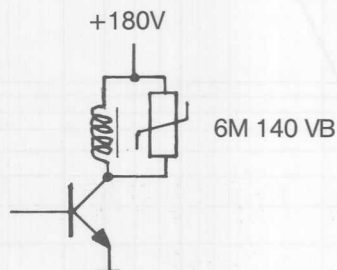

Figure 5: Circuit diagram of an application example

## 9. Questionnaire

If you cannot find the type you need in the type list, please specify the following when making inquiries and orders:

- a) What is to be achieved by the CONOX<sup>®</sup> varistor? Please provide a brief description of the circuit including a sketch and values.
- b) Which maximum operating voltage will be continuously applied to the varistor?  
DC voltage (smoothed) : ..... V ± ..... %  
rectified AC voltage : ..... V ± ..... %  
Type of rectification:    half-wave rectification  
                              full-wave rectification  
                              three-phase bridge  
                              other form of rectification  
rms AC voltage: ..... V ± ..... % ..... Hz.  
If sinusoidal voltages or pulses are involved, e.g. in the case of thyristors or transducers, please fully specify the waveform.
- c) Nominal current of the load (coil, field)  
in the case of direct current: ..... A.  
Magnetization current or quiescent current (transformer, coil)  
in the case of alternating current: ..... A.
- d) Inductance: ..... H.  
or the energy stored in the filed or coil: ..... J.
- e) Switching frequency: ..... /sec  
(how often is the coil or field etc. switched?)
- f) Required limiting of voltage peaks during switch-off to: ..... V.
- g) Ambient temperature: ..... K.
- h) Please precisely specify off times and operating times if the operating voltage is not continuously applied.
- i) circuit diagram

**C. CONRADTY**  
**NÜRNBERG** GmbH & Co. KG

Post Box 1752  
D-8500 Nürnberg  
Telephone (09 11) 598-1  
Telegrams Ceconradty Nürnberg  
Telex 622 391 ccnbg d

## 9. Questionnaire

If you cannot find the type you need in the type list, please specify the following when writing your order:

- a) What is to be achieved by the CONRADY variant? Please provide a brief description of the circuit including a sketch and values.
- b) Which maximum operating voltage will be continuously applied to the variant?
  - DC voltage (imposed):  $V_{DC}$  \_\_\_\_\_ V
  - rectified AC voltage:  $V_{AC}$  \_\_\_\_\_ V
  - Type of rectification: half-wave rectification
  - full-wave rectification
  - three-phase bridge
  - other form of rectification
- c) rms AC voltage:  $V_{rms}$  \_\_\_\_\_ V
- d) standard voltages or pulses are involved, e.g. in the case of thyristors or triac-based circuits, specify the waveform.
- e) Nominal current of the load (coil field): \_\_\_\_\_ A
- f) in the case of direct current: \_\_\_\_\_ A
- g) Magnetron current or pulse current (transformer coil) \_\_\_\_\_ A
- h) in the case of alternating current: \_\_\_\_\_ A
- i) Inductance: \_\_\_\_\_ H
- j) or the energy stored in the field or coil: \_\_\_\_\_ J
- k) Switching frequency: \_\_\_\_\_ kHz
- l) How often is the coil or field etc. switched? \_\_\_\_\_
- m) Required timing of voltage pulse during switch-off: \_\_\_\_\_  $\mu$ s
- n) Ambient temperature: \_\_\_\_\_ K
- o) Please specify duty cycle of times and operating time if the operating voltage is not continuously applied.
- p) Circuit diagram

**C. CONRADTY**  
**NÜRNBERG**  
 GmbH & Co. KG

Post Box 1785  
 D-8500 Nürnberg  
 Telephone (0911) 588-1  
 Telex 522 991 conrdy d  
 Telegrams Conradty Nürnberg

# 10. Production range

For a long time now, electrical carbon, electrical graphite and the special materials manufactured by us have been indispensable materials of modern industry thanks to their particular physical, electrical and chemical properties. C. Conradt is one of the most important and long-standing manufacturers of these products and has been active in this special field since 1855. The production range includes:

## 1. Metallurgical products

- Graphite electrodes
- Carbon electrodes
- Graphite heating elements and contact pieces
- Ground carbons (cathodes)
- Carbon bricks
- Anode plates
- Carburizing materials
- Gouging blowpipe carbons
- Carbon welding rods
- Graphite molds
- Carbon and electrical graphite tubes
- Carbon and electrical graphite crucible
- Saggars and plates of carbon and electrical graphite
- Graphite bars and blocks
- Graphite-shaped elements
- Graphite tubes
- Graphite cylinders and plates
- Heating elements
- Graphite plates and graphite canisters

## 2. Chemical products

- Anode plates and power busbars
- High load anodes
- Coated titanium anodes
- Platelets and granulate
- Carbon and graphite bricks
- Carbon and graphite tubes
- Carbon and graphite seals and bearings
- Carbon heating elements
- Graphite rods, blocks and plates
- Graphite rollers and shaped elements
- Porous carbons
- Carbon plates and rods
- Carbon and graphite felts CECOTEX®
- Reaction carbons
- Column fillers



### 3. Electrical engineering products

- Carbon, graphite and metal brushes
- Plates of carbon and electrical graphite
- Carbon grinding strips
- Carbon grinding elements
- Telephone carbons
- Carbon regulator rings
- Tube anodes
- OCELIT<sup>®</sup> varistors
- CONOX<sup>®</sup> varistors
- OCELIT<sup>®</sup> resistors
- SILICO<sup>®</sup> resistors

### 4. Products for mechanical engineering

- Carbon and graphite bearings
- Carbon and graphite seals
- Graphite sliding rails
- Carbon and graphite lines
- Graphite lubrication plates
- Graphite electrodes for spark erosion

### 5. Products for lighting systems

- Arc light carbons for
  - cinema projection
  - the graphic industry
  - therapeutic applications
  - colorfastness testers

### 6. Products for medicine technique

- Therapeutic carbons
- Dental crucibles

Please ask for the corresponding special brochure from

C. Conradt Nürnberg GmbH & Co. KG

Post Box 1752  
D-8500 Nürnberg 1  
Telephone (0911) 598-1  
Telegrams Ceconradt Nürnberg  
telex 622 391 ccnbg d